

AXIS M10 Network Camera Series

AXIS M1045-LW Network Camera

AXIS M1065-LW Network Camera

Installation Guide

Read this first

Read through this Installation Guide carefully before installing the product. Keep the Installation Guide for future reference.

Legal considerations

Video and audio surveillance can be regulated by laws that vary from country to country. Check the laws in your local region before using this product for surveillance purposes.

This product includes the following licenses:

- one (1) AAC decoder license
- one (1) H.264 decoder license

To purchase further licenses, contact your reseller.

Liability

Every care has been taken in the preparation of this document. Please inform your local Axis office of any inaccuracies or omissions. Axis Communications AB cannot be held responsible for any technical or typographical errors and reserves the right to make changes to the product and manuals without prior notice. Axis Communications AB makes no warranty of any kind with regard to the material contained within this document, including, but not limited to, the implied warranties of merchantability and fitness for a particular purpose. Axis Communications AB shall not be liable nor responsible for incidental or consequential damages in connection with the furnishing, performance or use of this material. This product is only to be used for its intended purpose.

Intellectual property rights

Axis AB has intellectual property rights relating to technology embodied in the product described in this document. In particular, and without limitation, these intellectual property rights may include one or more of the patents listed at axis.com/patent and one or more additional patents or pending patent applications in the US and other countries.

This product contains licensed third-party software. See the menu item "About" in the product's user interface for more information.

This product contains source code copyright Apple Computer, Inc., under the terms of Apple Public Source License 2.0 (see opensource.apple.com/apsl). The source code is available from developer.apple.com/bonjour/.

Equipment modifications

This equipment must be installed and used in strict accordance with the instructions given in the user documentation. This equipment contains no user-serviceable components. Unauthorized equipment changes

or modifications will invalidate all applicable regulatory certifications and approvals.

Trademark acknowledgements

AXIS COMMUNICATIONS, AXIS, ARTPEC and VAPIX are registered trademarks of Axis AB in various jurisdictions. All other trademarks are the property of their respective owners.

Apple, Apache, Bonjour, Ethernet, Internet Explorer, Linux, Microsoft, Mozilla, Real, SMPTE, QuickTime, UNIX, Windows, and WWW are registered trademarks of the respective holders. Java and all Java-based trademarks and logos are trademarks or registered trademarks of Oracle and/or its affiliates. The UPnP Word Mark and UPnP Logo are trademarks of Open Connectivity Foundation, Inc. in the United States or other countries.

WPA, WPA2 and Wi-Fi Protected Setup are marks of the Wi-Fi Alliance.

Regulatory information

Europe



This product is restricted to indoor use only.

This product complies with the applicable CE marking directives:

- Electromagnetic Compatibility (EMC) Directive 2014/30/EU. See *Electromagnetic compatibility (EMC) on page 2*.
- Radio Equipment Directive (RED) 2014/53/EU. See *Radio transmission on page 3*.
- Low Voltage Directive (LVD) 2014/35/EU. See *Safety on page 5*.
- Restriction of Hazardous Substances (RoHS) Directive 2011/65/EU and 2015/863, including any amendments, updates or replacements. See *Disposal and recycling on page 5*.

A copy of the original declaration of conformity may be obtained from Axis Communications AB. See *Contact information on page 6*.

Electromagnetic compatibility (EMC)

This equipment has been designed and tested to fulfill applicable standards for:

- Radio frequency emission when installed according to the instructions and used in its intended environment.
- Immunity to electrical and electromagnetic phenomena when installed according to the instructions and used in its intended environment.

USA

This device complies with part 15 of the FCC Rules. Operation is subject to the following two conditions:

1. This device may not cause harmful interference, and
2. this device must accept any interference received, including interference that may cause undesired operation.

This equipment has been tested using a shielded network cable (STP) and found to comply with the limits for a Class B digital device, pursuant to part 15 of the FCC Rules. These limits are designed to provide reasonable protection against harmful interference in a residential installation. This equipment generates, uses and can radiate radio frequency energy and, if not installed and used in accordance with the instructions, may cause harmful interference to radio communications. However, there is no guarantee that interference will not occur in a particular installation. If this equipment does cause harmful interference to radio or television reception, which can be determined by turning the equipment off and on, the user is encouraged to try to correct the interference by one or more of the following measures:

- Reorient or relocate the receiving antenna.
- Increase the separation between the equipment and receiver.
- Connect the equipment into an outlet on a circuit different from that to which the receiver is connected.
- Consult the dealer or an experienced radio/TV technician for help.

The product shall be connected using a shielded network cable (STP) that is properly grounded.

Contact information

Axis Communications Inc.
300 Apollo Drive
Chelmsford, MA 01824
United States of America
Tel: +1 978 614 2000

Canada

This digital apparatus complies with CAN ICES-3 (Class B). The product shall be connected using a shielded network cable (STP) that is properly grounded. Cet appareil numérique est conforme à la norme CAN NMB-3 (classe B). Le produit doit être connecté à l'aide d'un câble réseau blindé (STP) qui est correctement mis à la terre.

Europe

This digital equipment fulfills the requirements for RF emission according to the Class B limit of EN 55032. The product shall be connected using a shielded network cable (STP) that is properly grounded.

Australia/New Zealand

This digital equipment fulfills the requirements for RF emission according to the Class B limit of AS/NZS CISPR 32. The product shall be connected using a shielded network cable (STP) that is properly grounded.

Japan

この装置は、クラスB機器です。この装置は、住宅環境で使用することを目的としています。この装置がラジオやテレビジョン受信機に近接して使用されると、受信障害を引き起こすことがあります。取扱説明書に従って正しい取り扱いをして下さい。VCCI-B

本製品は、シールドネットワークケーブル(STP)を使用して接続してください。また適切に接地してください。本製品は電気通信事業者(移動通信会社、固定通信会社、インターネットプロバイダ等)の通信回線(公衆無線LANを含む)に直接接続することができません。本製品をインターネットに接続する場合は、必ずルータ等を経由して接続してください。

Korea

이 기기는 가정용(B급) 전자파적합기기로서 주로 가정에서 사용하는 것을 목적으로 하며, 모든 지역에서 사용할 수 있습니다. 적절히 접지된 STP (shielded twisted pair) 케이블을 사용하여 제품을 연결 하십시오.

Radio transmission

This radio equipment operates at 2.4 and 5.2 GHz, with a maximum output power of 100 and 200 mW respectively.

This equipment may generate or use radio frequency energy. The user could lose the authority to operate this equipment if an unauthorized change or modification is made.

USA

This product complies with FCC radiation exposure limits for an uncontrolled environment.

Canada

This device complies with Innovation, Science and Economic Development Canada licence-exempt RSS standard(s). Operation is subject to the following two conditions: (1) this device may not cause interference, and (2) this device must accept any interference, including interference that may cause undesired operation of the device.

This device complies with IC radiation exposure limits for an uncontrolled environment.

This device for operation in the frequency band 5150-5250 MHz is only for indoor use to reduce the potential for harmful interference to co-channel mobile satellite systems.

Le présent appareil est conforme aux CNR Innovation, Sciences et Développement

économique Canada applicables aux appareils radio exempts de licence. L'exploitation est autorisée aux deux conditions suivantes : (1) l'appareil ne doit pas produire de brouillage, et (2) l'utilisateur de l'appareil doit accepter tout brouillage radioélectrique subi, même si le brouillage est susceptible d'en compromettre le fonctionnement.

Ce produit est conforme aux limites d'exposition aux radiations IC pour un environnement non contrôlé.

Dans la bande de fréquences de 5 150 à 5 250 MHz, cet appareil doit uniquement être utilisé à l'intérieur afin de réduire le risque de brouillage préjudiciable de systèmes de service mobile par satellite se trouvant dans le même canal.

Europe

Hereby, Axis Communications AB declares that this product is in compliance with the essential requirements and other relevant provisions of Directive 2014/53/EU.

FR

Par la présente Axis Communications AB déclare que l'appareil ce produit est conforme aux exigences essentielles et aux autres dispositions pertinentes de la directive 2014/53/UE.

DE

Hiermit erklärt Axis Communications AB, dass sich dieses Produkt in Übereinstimmung mit den grundlegenden Anforderungen und den anderen relevanten Vorschriften der Richtlinie 2014/53/EU befindet.

IT

Con la presente Axis Communications AB dichiara che questo prodotto è conforme ai requisiti essenziali ed alle altre disposizioni pertinenti stabilite dalla direttiva 2014/53/UE.

ES

Por medio de la presente Axis Communications AB declara que el este producto cumple con los requisitos esenciales y cualesquiera otras disposiciones aplicables o exigibles de la Directiva 2014/53/UE.

FI

Axis Communications AB vakuuttaa täten että tämä tuote tyypinen laite on direktiivin 2014/53/EU oleellisten vaatimusten ja sitä koskevien direktiivin muiden ehtojen mukainen.

NL

Hierbij verklaart Axis Communications AB dat het toestel in overeenstemming is met de essentiële eisen en de andere relevante bepalingen van richtlijn 2014/53/EU.

SV

Härmed intygar Axis Communications AB att denna produkt står i överensstämmelse med de väsentliga egenskapskrav och övriga relevanta bestämmelser som framgår av direktiv 2014/53/EU.

DA

Undertegnede Axis Communications AB erklærer herved, at følgende udstyr overholder de væsentlige krav og øvrige relevante krav i direktiv 2014/53/EU.

PT

Axis Communications AB declara que este produto está conforme com os requisitos essenciais e outras disposições da Directiva 2014/53/UE.

EL

Με την παρούσα η Axis Communications AB δηλώνει ότι αυτό το προϊόν συμμορφώνεται προς τις ουσιαστικές απαιτήσεις και τις λοιπές σχετικές διατάξεις της οδηγίας 2014/53/ΕΕ.



This equipment can be used in the following countries:

AT, BE, BG, CH, CY, CZ, DE, DK, EE, EL, ES, FI, FR, HR, HU, IE, IS, IT, LI, LT, LU, LV, MT, NL, NO, PL, PT, RO, SE, SI, SK, TR, UK

Australia/New Zealand

This digital equipment fulfills the requirements of the Radio Communications Standard AS/NZS 4268.

제품사양

- 사용온도 : 0°C~45°C(32°F~113°F), 습도 (20~80%)
- 전원 : 4.9~5.1V DC, Max. 6.5W 또는 Power over Ethernet IEEE 802.3af/802.3at Type1 Class1

적합성 평가를 받은 자의 상호 : Axis

Communications AB
기자재의 명칭 (모델명) : Network Camera (M1025)

인증번호 : MSIP-REM-PNB-M1025

제조사/제조국가 : Axis Communications

AB/Sweden

제조년월 : 별도 표시

A/S정보

Axis Communications AB 한국지사

주소 : 서울특별시 금천구 가산동 685번지
가산디지털 엠파이어 1012호

TEL : 82-2-780-9636

FAX : 82-2-6280-9636

Taiwan

取得審驗證明之低功率射頻器材，非經核准，公司、商號或使用者均不得擅自變更頻率、加大功率或變更原設計之特性及功能。低功率射頻器材之使用不得影響飛航安全及干擾合法通信；經發現有干擾現象時，應立即停用，並改善至無干擾時方得繼續使用。前述合法通信，指依電信管理法規作業之無線電通信。低功率射頻器材須忍受合法通信或工業、科學及醫療用電波輻射性電機設備之干擾。

- (1)應避免影響附近雷達系統之操作
 (2)高增益指向性天線只得應用於固定式點對點系統

Japan

本製品は、特定無線設備の技術基準適合証明を受けています。

Brazil

Este produto está homologado pela ANATEL, de acordo com os procedimentos regulamentados pela Resolução 242/2000 e atende aos requisitos técnicos aplicados.

Este equipamento opera em caráter secundário, isto é, não tem direito a proteção contra interferência prejudicial, mesmo de estações do mesmo tipo, e não pode causar interferência a sistemas operando em caráter primário.

O produto foi concebido para ser instalado em uma altura mínima de 2 m entre o usuário e o dispositivo, fora do alcance do público em geral. Uma vez instalada por uma pessoa técnica, este produto não será mais manuseado pelo usuário.

Para maiores informações, consulte o site da ANATEL www.anatel.gov.br.

Mexico

La operación de este equipo está sujeta a las siguientes dos condiciones:

1. Es posible que este equipo o dispositivo no cause interferencia perjudicial.
2. Este equipo o dispositivo debe aceptar cualquier interferencia. Incluyendo la que pueda causar su operación no deseada.

Safety

The power supply used with this product shall fulfill one of the following requirements:

- Safety Extra Low Voltage (SELV) according to clause 2.2 of IEC/EN/UL 60950-1 and Limited Power Source (LPS) according to clause 2.5 of IEC/EN/UL 60950-1 or CEC/NEC Class 2 source of supply as defined in the Canadian Electrical Code, CSA C22.1 and National Electrical Code, ANSI/NFPA 70
- Class 1 electrical energy source (ES1) and Class 2 power source (PS2) rated output power limited to ≤100 W according to IEC/EN/UL 62368-1

Disposal and recycling

When this product has reached the end of its useful life, dispose of it according to local laws and regulations. For information about your nearest designated collection point, contact your local authority responsible for waste disposal. In accordance with local legislation, penalties may be applicable for incorrect disposal of this waste.

Europe



This symbol means that the product shall not be disposed of together with household or commercial waste. Directive 2012/19/EU on waste electrical and electronic equipment (WEEE) is applicable in the European Union member states. To prevent potential harm to human health and the environment, the product must be disposed of in an approved and environmentally safe recycling process. For information about your nearest designated collection point, contact your local authority responsible for waste disposal. Businesses should contact the product supplier for information about how to dispose of this product correctly.

This product complies with the requirements of Directive 2011/65/EU and 2015/863 on the restriction of the use of certain hazardous substances in electrical and electronic equipment (RoHS).

China



This product complies with the requirements of SJ/T 11364-2014, Marking for the restriction of hazardous substances in electrical and electronic products.

有毒有害物质或元素						
部件名称	铅 (P- b)	汞 (H- g)	镉 (C- d)	六价铬 (C- r(V- I))	多溴联苯 (P- B- B)	多溴二苯醚 (P- B- D- E)

电气 实装 部分	X	0	0	0	0	0
<p>0: 表示该有毒有害物质在该部件均质材料中的含量均在GB/T 26572标准规定的限量要求以下。</p> <p>X: 表示该有毒有害物质至少在该部件的某一均质材料中的含量超出GB/T 26572标准规定的限量要求。</p>						

Contact information

Axis Communications AB
Gränden 1
223 69 Lund
Sweden

Tel: +46 46 272 18 00

Fax: +46 46 13 61 30

axis.com

Warranty information

For information about Axis' product warranty and thereto related information, go to axis.com/warranty.

Support

Should you require any technical assistance, please contact your Axis reseller. If your questions cannot be answered immediately, your reseller will forward your queries through the appropriate channels to ensure a rapid response. If you are connected to the Internet, you can:

- download user documentation and software updates
- find answers to resolved problems in the FAQ database, search by product, category, or phrase
- report problems to Axis support staff by logging in to your private support area
- chat with Axis support staff
- visit Axis Support at axis.com/support

Learn more!

Visit Axis learning center axis.com/learning for useful trainings, webinars, tutorials and guides.

English

Safety instructions

⚠ CAUTION



IR is emitted from this product. It can be harmful to the eyes. Avoid eye exposure. Use shielding or eye protection.

NOTICE

- The Axis product shall be used in compliance with local laws and regulations.
- Axis recommends using a shielded network cable (STP).
- Axis recommends using a network cable of category CAT5e or higher.
- Store the Axis product in a dry and ventilated environment.
- Avoid exposing the Axis product to shocks or heavy pressure.
- Do not install the product on unstable poles, brackets, surfaces or walls.
- Use only applicable tools when installing the Axis product. Using excessive force with power tools could cause damage to the product.
- Do not use chemicals, caustic agents, or aerosol cleaners.
- Use a clean cloth dampened with pure water for cleaning.
- Use only accessories that comply with the technical specification of your product. These can be provided by Axis or a third party. Axis recommends using Axis power source equipment compatible with your product.
- Use only spare parts provided by or recommended by Axis.
- Do not attempt to repair the product yourself. Contact Axis support or your Axis reseller for service matters.
- The power supply shall be plugged in to a socket outlet installed near the product and shall be easily accessible.
- Use a limited power source (LPS) with a rated output power limited to ≤ 100 W and a rated output current limited to ≤ 5 A.

Transportation

NOTICE

- When transporting the Axis product, use the original packaging or equivalent to prevent damage to the product.

Battery

⚠ CAUTION

Do not replace the battery yourself. Contact Axis support if the log message requests a battery change.

Lithium coin cell 3.0 V batteries contain 1,2-dimethoxyethane; ethylene glycol dimethyl ether (EGDME), CAS no. 110-71-4.

Dome cover

NOTICE

- Be careful not to scratch, damage or leave fingerprints on the dome cover because this could decrease image quality. If possible, keep the protective plastic on the dome cover until the installation is complete.
- Do not clean a dome cover that looks clean to the eye and never polish the surface. Excessive cleaning could damage the surface.
- For general cleaning of the dome cover it is recommended to use a non-abrasive, solvent-free neutral soap or detergent mixed with pure water and a soft, clean cloth. Rinse well with pure lukewarm water. Dry with a soft, clean cloth to prevent water spotting.
- Never use harsh detergents, gasoline, benzene, acetone, or similar chemicals.
- Avoid cleaning the dome cover in direct sunlight or at elevated temperatures.

Français

Consignes de sécurité

⚠ ATTENTION



IR émis par ce produit. Cela peut être nocif pour les yeux. Évitez toute exposition des yeux. Utilisez un écran ou une protection oculaire.

AVIS

- Le produit Axis doit être utilisé conformément aux lois et règlements locaux.
- Axis recommande d'utiliser un câble réseau blindé (STP).
- Axis recommande d'utiliser un câble réseau de catégorie CAT5e ou supérieure.
- Conserver ce produit Axis dans un environnement sec et ventilé.
- Ne pas exposer ce produit Axis aux chocs ou aux fortes pressions.
- Ne pas installer ce produit sur des poteaux, supports, surfaces ou murs instables.
- Utiliser uniquement des outils recommandés pour l'installation de l'appareil Axis. L'application d'une force excessive sur l'appareil avec des outils puissants pourrait l'endommager.

- Ne pas utiliser de produits chimiques, de substances caustiques ou de nettoyeurs pressurisés.
- Utiliser un chiffon propre imbibé d'eau pure pour le nettoyage.
- Utiliser uniquement des accessoires conformes aux caractéristiques techniques de votre produit. Ils peuvent être fournis par Axis ou un tiers. Axis recommande d'utiliser un équipement d'alimentation Axis compatible avec votre produit.
- Utiliser uniquement les pièces de rechange fournies ou recommandées par Axis.
- Ne pas essayer de réparer vous-même ce produit. Contacter l'assistance technique d'Axis ou votre revendeur Axis pour des problèmes liés à l'entretien.
- L'alimentation électrique doit être branchée à une prise de courant installée près de l'équipement et être facilement accessible.
- Utilisez une source d'alimentation limitée (LPS) dont la puissance de sortie nominale est limitée à ≤ 100 W et dont le courant de sortie nominal est limité à ≤ 5 A.
- N'utilisez jamais de détergents agressifs, d'essence, de benzène, d'acétone ou autres produits chimiques similaires.
- Évitez de nettoyer le couvercle du dôme dans la lumière directe du soleil où lorsque les températures sont élevées.

Deutsch

Sicherheitsanweisungen

⚠ VORSICHT



Von diesem Produkt geht Infrarotstrahlung aus. Diese kann zu Augenschäden führen. Augenexposition vermeiden. Verwenden Sie eine Blende bzw. einen Augenschutz.

HINWEIS

- Das Axis Produkt muss unter Beachtung der geltenden Gesetze und Bestimmungen betrieben werden.
- Axis empfiehlt, ein abgeschirmtes Netzwerk-Kabel (STP) zu verwenden.
- Axis empfiehlt, ein abgeschirmtes Netzwerk-Kabel der Kategorie CAT5e oder höher zu verwenden.
- Lagern Sie das Axis Produkt in einer trockenen und belüfteten Umgebung.
- Das Axis Produkt weder Stößen noch starkem Druck aussetzen.
- Das Produkt nicht an instabilen Masten, Halterungen, Oberflächen oder Wänden anbringen.
- Verwenden Sie bei der Installation des Axis Produkts ausschließlich passende Werkzeuge. Ein zu großer Kraftaufwand mit elektrischen Werkzeugen kann das Produkt beschädigen.
- Verwenden Sie keine chemischen, ätzenden oder aerosolhaltigen Reinigungsmittel.
- Verwenden Sie zum Reinigen ein sauberes, mit destilliertem Wasser angefeuchtetes Tuch.
- Verwenden Sie nur Zubehör, das den technischen Vorgaben Ihres Produkts entspricht. Dieses ist von Axis oder Drittanbietern erhältlich. Axis empfiehlt die mit Ihrem Produkt kompatible Stromversorgung von Axis.
- Verwenden Sie ausschließlich Ersatzteile die von Axis angeboten oder empfohlen werden.
- Versuchen Sie nicht, dieses Produkt selbsttätig zu reparieren. Wenden Sie sich bezüglich Reparatur und Wartung an den Axis Support oder Ihren Axis Händler.

Transport

AVIS

- Lors du transport du produit Axis, utilisez l'emballage d'origine ou un équivalent pour éviter d'endommager le produit.

Batterie

⚠ ATTENTION

Ne remplacez pas la batterie vous-même. Contactez le support Axis si le message du journal demande un changement de batterie.

Les piles boutons 3,0 V au lithium contiennent du 1,2-diméthoxyéthane, éthylène glycol diméthyl éther (EGDME), CAS n° 110-71-4.

Couvercle de dôme

AVIS

- Veillez à ne pas rayer, endommager ou laisser d'empreintes sur le couvercle du dôme car cela pourrait altérer la qualité d'image. Laissez, si possible, la protection en plastique sur le couvercle du dôme jusqu'à la fin de l'installation.
- Ne nettoyez pas le couvercle du dôme s'il semble propre à l'œil nu et ne frottez jamais sa surface. Un nettoyage excessif pourrait endommager la surface.
- Pour le nettoyage général du couvercle du dôme, il est recommandé d'utiliser un produit non abrasif, un savon neutre sans solvant ou un détergent mélangé avec de l'eau pure et un chiffon doux propre. Rincez bien à l'eau tiède pure. Séchez avec un chiffon doux et propre pour éviter les tâches d'eau.

- Das Netzteil sollte an eine Steckdose in der Nähe des Produkts angeschlossen werden und leicht zugänglich sein.
- Verwenden Sie eine Stromquelle mit begrenzter Leistung (LPS) mit einer Nennausgangsleistung von ≤ 100 W und einem begrenzten Nennausgangsstrom von ≤ 5 A.

Transport

HINWEIS

- Bei Bedarf transportieren Sie das Axis Produkt in der Originalverpackung oder einer entsprechenden Verpackung, so dass Schäden vermieden werden.

Batterie

VORSICHT

Tauschen Sie die Batterie nicht selbst aus. Wenden Sie sich an den Axis Support, wenn die Protokollnachricht einen Batterietausch anfordert.

Lithium-Knopfzellen (3,0 V) enthalten 1,2-Dimethoxyethan; Ethylenglycoldimethylether (EGDME), CAS-Nr. 110-71-4.

Kuppelabdeckung

HINWEIS

- Achten Sie darauf, die Kuppelabdeckung weder zu zerkratzen, zu beschädigen oder darauf Fingerabdrücke zu hinterlassen, da dies die Bildqualität beeinträchtigen kann. Falls möglich, entfernen Sie die Schutzfolie erst nach Abschluss der Installation.
- Säubern Sie die Kuppelabdeckung nicht, wenn diese sauber erscheint, und polieren Sie niemals die Oberfläche. Zu häufiges Säubern kann die Oberfläche beschädigen.
- Für die normale Reinigung der Kuppelabdeckung werden eine nicht-scheuernde, lösungsmittelfreie neutrale Seife oder ein entsprechendes Reinigungsmittel mit destilliertem Wasser und ein sauberer, weicher Lappen empfohlen. Spülen Sie die Kuppelabdeckung gründlich mit lauwarmem destilliertem Wasser ab. Trocknen Sie die Kuppelabdeckung mit einem weichen, sauberen Tuch, um Wasserflecken zu vermeiden.
- Keine aggressiven Reinigungsmittel, Waschbenzin, Benzol, Aceton oder ähnliche Chemikalien verwenden.
- Die Kuppelabdeckung nicht in direktem Sonnenlicht oder bei erhöhten Temperaturen säubern.

Italiano

Informazioni di sicurezza

ATTENZIONE



Questo dispositivo emette infrarossi. Potrebbe essere dannoso per gli occhi. Evita che gli occhi vi siano esposti. Utilizza una schermatura o una protezione per gli occhi.

AWISO

- Il dispositivo Axis deve essere utilizzato in conformità alle leggi e alle normative locali.
- Axis consiglia l'uso di un cavo di rete schermato (STP).
- Axis consiglia di utilizzare un cavo di rete di categoria CAT5e o versione successiva.
- Conservare il dispositivo Axis in un ambiente asciutto e ventilato.
- Evitare di esporre il dispositivo Axis a urti o pressioni eccessive.
- Non installare il dispositivo su supporti, superfici, pareti o pali instabili.
- Utilizzare solo strumenti applicabili quando si installa il dispositivo Axis. Se si utilizza una forza eccessiva con strumenti non adatti è possibile causare danni al dispositivo.
- Non utilizzare sostanze chimiche, agenti caustici o detergenti aerosol.
- Utilizzare un panno pulito inumidito in acqua pura per la pulizia.
- Utilizzare solo accessori compatibili con le specifiche tecniche del dispositivo. Questi possono essere forniti da Axis o da terze parti. Axis consiglia l'uso dell'apparecchiatura di alimentazione Axis compatibile con il dispositivo.
- Utilizzare solo parti di ricambio fornite o consigliate da Axis.
- Non tentare di riparare il dispositivo da soli. Contattare l'assistenza o il rivenditore Axis per questioni relative alla manutenzione.
- L'alimentatore deve essere collegato a una presa di corrente vicina al dispositivo e facilmente accessibile.
- Utilizzare una sorgente di alimentazione limitata (LPS) con una potenza di uscita nominale limitata a ≤ 100 W e una corrente di uscita nominale limitata a ≤ 5 A.

Transporto

AWISO

- Durante il trasporto del dispositivo Axis, utilizzare l'imballaggio originale o equivalente per evitare danni al dispositivo.

Batteria

ATTENZIONE

Non sostituire la batteria da soli. Contattare l'assistenza di Axis se il messaggio di registro richiede una sostituzione della batteria.

Le batterie a bottone al litio da 3 V contengono 1,2-dimetossietano; etere dimetilico di glicole etilenico (EGDME), CAS n. 110-71-4.

Copertura a cupola

AVISO

- Fare attenzione a non graffiare, danneggiare o lasciare impronte sulla cupola di protezione, perché potrebbe diminuire la qualità dell'immagine. Se possibile, tenere la protezione in plastica sul coperchio della cupola fino a quando l'installazione non sarà completata.
- Non pulire il coperchio della cupola quando allo sguardo sembra pulito e non lucidare la superficie. Una pulizia eccessiva potrebbe danneggiare la superficie.
- Per la pulizia generale del coperchio della cupola, si consiglia di utilizzare un sapone neutro o detergente non abrasivo con acqua pura e un panno morbido e pulito. Sciacquare bene con acqua pura tiepida. Asciugare con un panno morbido e pulito per evitare macchie d'acqua.
- Non usare mai detersivi aggressivi, benzina, benzene, acetone o sostanze chimiche simili.
- Evitare di pulire il coperchio della cupola alla luce diretta del sole o a temperature elevate.

Español

Instrucciones de seguridad

⚠ PRECAUCIÓN



Este producto emite infrarrojos. Puede dañar los ojos. Evite la exposición prolongada de los ojos. Utilice protectores o dispositivos de protección para los ojos.

AVISO

- Este producto de Axis debe utilizarse de acuerdo con las leyes y normativas locales.
- Axis recomienda utilizar un cable de red blindado (STP).
- Axis recomienda utilizar un cable de red de categoría CAT5e o superior.
- Almacene el producto de Axis en un entorno seco y ventilado.
- Evite la exposición del producto de Axis a choques o a una fuerte presión.

- No instale el producto en postes, soportes, superficies o paredes inestables.
- Utilice solo las herramientas correspondientes cuando instale el producto de Axis. La aplicación de una fuerza excesiva con herramientas eléctricas puede provocar daños en el producto.
- No utilice limpiadores en aerosol, agentes cáusticos ni productos químicos.
- Limpie con un paño limpio humedecido con agua pura.
- Utilice solo accesorios que cumplan con las especificaciones técnicas de su producto. Estos accesorios los puede proporcionar Axis o un tercero. Axis recomienda utilizar un equipo de suministro de alimentación de Axis compatible con su producto.
- Utilice solo piezas de repuesto proporcionadas o recomendadas por Axis.
- No intente reparar el producto usted mismo. Póngase en contacto con el servicio de asistencia técnica de Axis o con su distribuidor de Axis para tratar asuntos de reparación.
- La fuente de alimentación se enchufará a una toma de conector instalada cerca del producto y a la que se podrá acceder fácilmente.
- Use una fuente de alimentación limitada (LPS) con una potencia nominal de salida limitada a ≤ 100 W y una corriente nominal de salida limitada a ≤ 5 A.

Transporte

AVISO

- Cuando transporte el producto de Axis, utilice el embalaje original o un equivalente para evitar daños en el producto.

Batería

⚠ PRECAUCIÓN

No sustituya la batería usted mismo. Póngase en contacto con el servicio de asistencia técnica de Axis si el mensaje de registro solicita un cambio de batería.

Las pilas de botón de litio de 3,0 V contienen 1,2-dimetoxietano; éter dimetilico de etilenglicol (EGDME), n.º CAS 110-71-4.

Cubierta del domo

AVISO

- Preste atención para no arañar, dañar o dejar las huellas en la cubierta del domo, puesto que esto puede provocar una disminución de la calidad de imagen. Si es posible, mantenga el plástico de protección en la cubierta del domo hasta que se complete la instalación.

- No limpie la cubierta del domo si parece a simple vista que está limpia y nunca pule la superficie. Una limpieza excesiva podría dañar la superficie.
- Para realizar un procedimiento de limpieza general de la cubierta del domo se recomienda usar detergente o jabón neutros, sin disolventes y no abrasivos mezclados con agua pura, y un paño suave y limpio. Enjuague bien con agua pura y tibia. Seque con un paño limpio y suave para evitar las manchas de gotas de agua.
- Nunca use detergentes abrasivos, gasolina, benceno, acetona o productos químicos similares.
- Evite limpiar la cubierta del domo a temperaturas elevadas o en contacto directo con la luz solar.

日本語

安全手順

▲注意



本製品は赤外線を放射します。眼に有害となる可能性があります。目に直接入らないように、シールドまたは目の保護具を使用してください。

注意

- 本製品は、お使いになる地域の法律や規制に準拠して使用してください。
- Axisは、シールドネットワークケーブル (STP) の使用を推奨します。
- Axisは、カテゴリ-CAT5e以上のネットワークケーブルの使用を推奨します。
- 本製品は乾燥した換気の良い環境に保管してください。
- 本製品に衝撃または強い圧力を加えないでください。
- 本製品を不安定なポール、ブラケット、表面、または壁に設置しないでください。
- 本製品を設置するには、適切な工具のみを使用してください。電動工具を使用して過剰な力をかけると、製品が損傷することがあります。
- 化学薬品、腐食剤、噴霧式クリーナーは使用しないでください。
- 清掃には、きれいな水に浸した清潔な布を使用してください。
- 製品の技術仕様に準拠したアクセサリのみを使用してください。これらのアクセサリは、Axisまたはサードパーティから入手できます。Axisは、ご使用の製品と互換性のあ

るAxis給電ネットワークスイッチの使用を推奨します。

- Axisが提供または推奨する交換部品ののみを使用してください。
- 製品を自分で修理しないでください。修理については、Axisサポートまたは販売代理店にお問い合わせください。
- 電源は、製品の近くで簡単に手の届く場所にあるコンセントに接続してください。
- 定格出力が100 Wかつ5 A以下の有限電源 (LPS) を使用します。

輸送

注意

- 本製品を運搬する際は、製品が損傷しないよう、元の梱包が同等の梱包を使用してください。

バッテリー

▲注意

自分でバッテリーを交換しないでください。バッテリー交換を求めるログメツセージが表示された場合は、Axisサポートにお問い合わせください。

リチウムコイン型3.0V電池は、1,2-ジメトキシエタン (エチレングリコールジメチルエーテル (EGDME)、CAS番号110-71-4) を含有しています。

ドームカバー

注意

- 画質低下の原因となるため、ドームカバーに傷や指紋を付けたり、損傷しないように注意してください。可能であれば、設置が完了するまでドームカバーに保護プラスチックを付けたままにしてください。
- 肉眼で見て汚れがない場合は、ドームカバーを掃除しないでください。また、絶対に表面を磨かないでください。過度な清掃により、表面が破損することがあります。
- ドームカバーの通常のクリーニングには、磨耗防止タイプの無溶媒の中性石鹸またはきれいな水で薄めた洗剤と、柔らかい清潔な布を使用することをお勧めします。洗浄後、きれいなぬるま湯でよくすすいでください。水滴の跡が付かないよう、清潔な柔らかい布で拭いて乾かしてください。
- 強力な洗剤、ガソリン、ベンジン、アセトン、同様の化学薬品は絶対に使用しないでください。
- 直射日光が当たる場所や気温が上昇する場所でのドームカバーの清掃は避けてください。

Português

Instruções de segurança

⚠️ CUIDADO



Este produto emite IR (infravermelho). Isso pode ser perigoso para os olhos. Evite a exposição dos olhos. Utilize blindagem ou proteção.

OBSERVAÇÃO

- O produto Axis deve ser usado em conformidade com as leis e regulamentações locais.
- A Axis recomenda usar um cabo de rede blindado (STP).
- A Axis recomenda usar um cabo de rede categoria CAT5e ou superior.
- Armazene o produto Axis em um ambiente seco e ventilado.
- Evite expor o produto Axis a impactos ou pressão elevada.
- Não instale o produto em suportes, mastros, superfícies ou paredes instáveis.
- Use apenas as ferramentas recomendadas ao instalar o produto Axis. O uso de força excessiva com ferramentas elétricas poderia danificar o produto.
- Não use produtos químicos, agentes cáusticos ou limpadores aerossóis.
- Use um pano limpo úmido para limpar o produto.
- Utilize apenas acessórios que atendam às especificações técnicas do produto. Esses poderão ser fornecidos pela Axis ou por terceiros. A Axis recomenda usar equipamento de fonte de alimentação Axis compatível com seu produto.
- Utilize apenas peças sobressalentes fornecidas ou recomendadas pela Axis.
- Não tente reparar o produto por conta própria. Entre em contato com o suporte ou seu revendedor Axis para quaisquer questões relacionadas a serviços.
- A fonte de alimentação deve ser conectada em uma tomada elétrica instalada próxima ao produto e deverá poder ser acessada com facilidade.
- Use uma fonte de energia com limitação (LPS) com potência de saída nominal restrita a ≤ 100 W e corrente de saída nominal limitada a ≤ 5 A.

Transporte

OBSERVAÇÃO

- Ao transportar o produto Axis, use a embalagem original ou equivalente para evitar danos ao produto.

Bateria

⚠️ CUIDADO

Não substitua a bateria por conta própria. Entre em contato com o suporte da Axis se a mensagem do log solicitar uma substituição de bateria.

As baterias tipo célula de íons de lítio de 3,0 V contêm 1,2-dimetoxietano; etileno glicol éter dimetilico (EGDME), nº CAS 110-71-4.

Cobertura dome

OBSERVAÇÃO

- Cuidado para não arranhar, danificar ou deixar impressões digitais na cobertura dome, pois isso poderia prejudicar a qualidade da imagem. Se possível, mantenha o plástico protetor na cobertura dome até que a instalação seja concluída.
- Não limpe uma dome que pareça limpa e jamais faça o polimento da superfície. A limpeza excessiva poderia danificar a superfície.
- Para a limpeza geral de uma dome, recomenda-se usar sabão ou detergente neutro não abrasivo e sem solventes dissolvido em água e um pano macio limpo. Enxágue bem com água limpa e morna. Seque com um pano macio e limpo para impedir o surgimento de manchas de água.
- Nunca use detergentes agressivos, gasolina, benzina, acetona ou produtos químicos semelhantes.
- Evite limpar a Cobertura dome sob luz do sol direta ou em temperaturas elevadas.

РУССКИЙ

Правила безопасности

⚠️ ОСТОРОЖНО



Это устройство является источником ИК-излучения. Это может быть вредно для глаз. Избегайте воздействия излучения на глаза. Используйте экранирование или средства защиты глаз.

ПРИМЕЧАНИЕ.

- Это изделие Axis следует использовать в соответствии с местными законами и нормативами.
- Компания Axis рекомендует использовать экранированный сетевой кабель (STP).
- Компания Axis рекомендует использовать сетевой кабель категории 5e или выше.

- Устройство Axis должно храниться в сухом, хорошо проветриваемом помещении.
- Не допускайте ударов или приложения высокого давления к устройству Axis.
- Не монтируйте устройство на неустойчивых столбах, кронштейнах, поверхностях или стенах.
- При установке устройства Axis используйте только предназначенные для этого инструменты. Приложение чрезмерных усилий к инструментам может привести к повреждению устройства.
- Не используйте химикалии, едкие вещества или аэрозольные очистители.
- Для очистки используйте чистую ткань, смоченную чистой водой.
- Используйте только принадлежности, которые соответствуют техническим характеристикам данного устройства. Они могут поставляться компанией Axis или сторонним производителем. Компания Axis рекомендует использовать блоки питания Axis, совместимые с устройством.
- Используйте только запасные части, поставляемые или рекомендованные компанией Axis.
- Не пытайтесь отремонтировать устройство самостоятельно. По вопросам обслуживания обращайтесь в службу поддержки Axis или к своему реселлеру Axis.
- Блок питания следует включать в розетку, к которой должен быть обеспечен удобный доступ недалеко от изделия.
- В целях безопасности используйте источник питания ограниченной мощности (LPS), у которого номинальная выходная мощность не превышает 100 Вт и либо номинальный выходной ток не превышает 5 А.

Транспортировка

ПРИМЕЧАНИЕ.

- При транспортировке устройства Axis используйте оригинальную упаковку или ее эквивалент во избежание повреждения изделия.

Батарея

⚠ ОСТОРОЖНО

Не заменяйте батарею самостоятельно. Если сообщение журнала содержит запрос на замену батареи, обратитесь в службу поддержки Axis.

Плоские литиевые батареи (3,0 В) содержат 1,2-диметоксиэтан – диметиловый эфир этиленгликоля (EGDME), CAS № 110-71-4.

Купол

ПРИМЕЧАНИЕ.

- Обращайтесь с куполом аккуратно. Старайтесь не поцарапать и не повредить его, а также не оставляйте на нем отпечатки пальцев, поскольку это может снизить качество изображения. По возможности не снимайте с купола защитную пластиковую пленку до завершения установки.
- Не протирайте купол, если на нем не заметны загрязнения, и ни при каких обстоятельствах не полируйте его поверхность. Излишняя очистка может привести к повреждению поверхности.
- Для общей очистки купола рекомендуется использовать мягкую чистую ткань и нейтральное мыло без растворителей и абразивных веществ или смесь моющего средства с чистой водой. После очистки тщательно промойте купол чистой теплой водой. Чтобы не допустить появления следов от капель воды, протрите купол мягкой чистой тканью.
- Никогда не используйте агрессивные моющие средства, например, бензин, бензол, ацетон или аналогичные химические вещества.
- Старайтесь не проводить очистку купола при прямом солнечном освещении или при повышенных температурах воздуха.

中文

安全说明

⚠ 警示

 本产品会发出红外线。可能伤害眼睛。避免直视。使用防护或目视保护。

注意

- 使用 Axis 产品时应遵守当地法律和法规。
- 安讯士推荐使用屏蔽网络电缆 (STP)。
- 安讯士建议使用类别 CAT5e 或更高级别的网线。
- 在干燥通风的环境中存放安讯士产品。
- 避免将安讯士产品暴露在冲击或高压环境下。
- 请勿将产品安装在不稳固的立杆、支架、表面或墙壁上。
- 安装安讯士产品时，仅使用适用的工具。使用电动工具过度施力可能导致产品损坏。
- 请勿使用化学品、腐蚀剂或气雾剂。

- 使用蘸纯净水的干净布进行清洁。
- 仅使用符合产品技术规格的附件。这些附件可由安讯士或第三方提供。安讯士推荐使用与产品兼容的安讯士电源设备。
- 仅使用安讯士提供或推荐的备件。
- 请勿尝试自行维修产品。有关服务事项，请联系安讯士支持部门或安讯士经销商。
- 电源应插入安装在产品附近的插座上并易于触及。
- 使用额定输出功率限制为 $\leq 100\text{ W}$ 和额定输出电流限制为 $\leq 5\text{ A}$ 的限制电源(LPS)。

运输

注意

- 安讯士产品运输途中，应使用其原包装或等效包装，以防对产品造成损坏。

电池

警告

请勿自行更换电池。如果日志消息要求更换电池，请联系安讯士支持部门。

3.0 V 纽扣锂电池内含 1,2-二甲氧基乙烷；乙二醇二甲醚(EGDME)，CAS 编号为 110-71-4。

半球罩

注意

- 小心不要划伤、损坏或在半球罩上留下指纹，因为这可能会降低图像质量。如果可能，请保留半球罩上的保护塑料，直至安装完成。
- 请勿清洁看起来干净的半球罩，也不要对表面进行抛光。过度清洁可能会损坏表面。
- 对于半球罩的一般清洁，建议将无腐蚀性、不含溶剂的中性肥皂或洗涤剂与纯水混合，并使用柔软、干净的布进行清洁。用温水冲洗干净。用一块柔软干净的布擦干，以避免留下水渍。
- 切勿使用带有刺鼻气味的洗涤剂、汽油、苯、丙酮或类似化学品。
- 避免在阳光直射或高温下清洁半球罩。

한국어

안전 지침

주의

 이 제품에서는 IR이 방출됩니다. 눈에 노출되지 않게 해로울 수 있습니다. 눈에 노출되지 않게 하십시오.

게 하십시오. 차폐 또는 눈 보호 장비를 사용하십시오.

통지

- Axis 제품은 해당 지역 법률 및 규정을 준수하여 사용해야 합니다.
- Axis는 차폐 네트워크 케이블(STP) 사용을 권합니다.
- Axis는 네트워크 케이블 CAT5 이상 사용을 권합니다.
- Axis 제품은 건조하고 환기가 잘 되는 곳에 보관하십시오.
- Axis 제품에 충격이나 강한 압력을 가하지 마십시오.
- 불안정한 폴 브래킷, 표면 또는 벽면에 제품을 설치하지 마십시오.
- Axis 제품을 설치할 경우 해당 도구만 사용하십시오. 전동 공구로 과도한 힘을 사용하면 제품에 손상을 줄 수 있습니다.
- 화학 물질, 부식제, 에어로졸 세제제를 사용하지 마십시오.
- 깨끗한 물에 적신 깨끗한 천을 사용하여 닦으십시오.
- 제품의 기술적 사양을 준수하는 액세서리만 사용하십시오. 이러한 액세서리는 Axis 또는 제3자가 제공할 수 있습니다. Axis는 귀하의 제품과 호환되는 Axis 전원 장비 사용을 권합니다.
- Axis가 공급하거나 추천하는 예비 부품만 사용하십시오.
- 제품을 직접 수리하려고 하지 마십시오. 서비스 문제에 대해 Axis 지원 부서 또는 Axis 리셀러에 문의하십시오.
- 전원 공급 장치는 제품 근처에 설치된 소켓 콘센트에 꽂아야 하며, 쉽게 접근할 수 있어야 합니다.
- 100W 이하로 제한된 정격 출력 전원 및 5A 이하로 제한된 정격 출력 전류로 제한된 전원(LPS)을 사용하십시오.

운반

통지

- Axis 제품을 운반할 때는 원래 포장이나 이에 준하는 포장을 사용해 제품이 손상되지 않도록 하십시오.

배터리

주의

배터리를 직접 교체하지 마십시오. 로그 메시지가 배터리 교체를 요청하면 Axis 지원 센터에 문의하십시오.

리튬 코인 셀 3.0V 배터리는 1,2-디메톡시에탄, EGDME(ethylene glycol dimethyl ether), CAS no. 110-71-4를 포함하고 있습니다.

돔 커버

통지

- 돔 커버가 긁히거나 손상되거나 지문 이 남지 않도록 주의하십시오. 이는 이미지가 품질을 저하시킬 수 있습니다. 가능하면 설치가 완료될 때까지 돔 커버의 보호 플라스틱을 제거하지 마십시오.
- 눈에 보기에 깨끗한 돔 커버는 닦지 않고 표면에 광을 내지 마십시오. 과도한 청소는 표면에 손상을 줄 수 있습니다.
- 돔 커버의 일반적인 청소를 위해서는 일반적 인 청소를 위해서는 세제를 무용제 중성 비누 또는 세제를 섞은 깨끗한 물 그리고 부드럽고 깨끗한 천을 사용하는 것이 좋습니다. 깨끗하고 미지근한 물로 잘 씻어내십시오. 얼룩이 남지 않도록 부드럽고 깨끗한 천으로 닦으십시오.
- 강력한 세제, 휘발유, 벤젠, 아세톤 또는 유사한 화학 물질을 사용하지 마십시오.
- 직사광선이 비치거나 온도가 높은 곳에서 돔 커버를 청소하지 마십시오.

AXIS M10 Network Camera Series

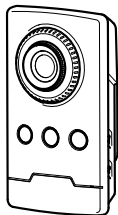
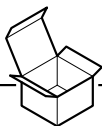

1x

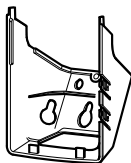

1x

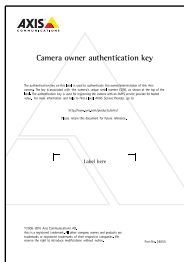

1x

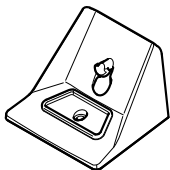

1x

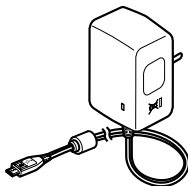

1x



2x

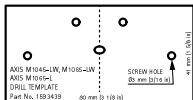

1x

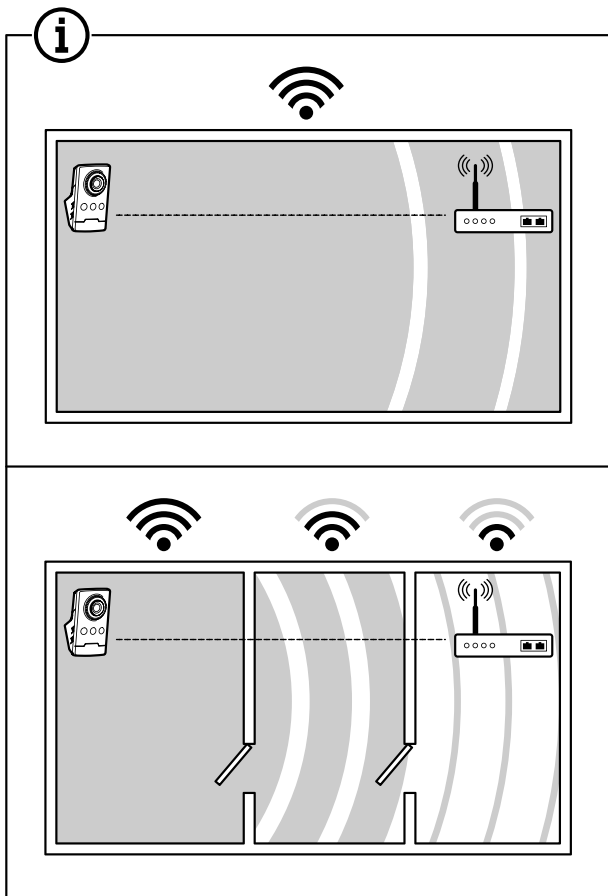

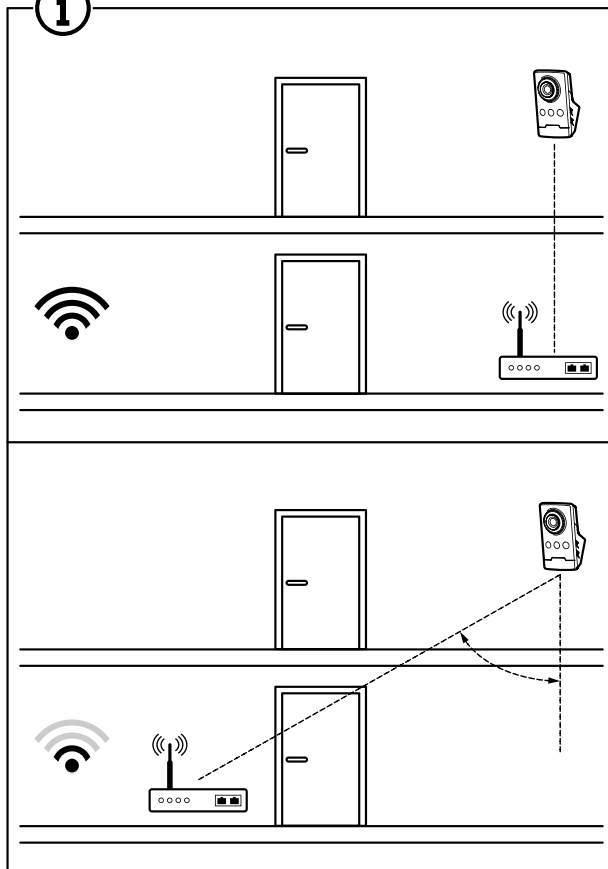

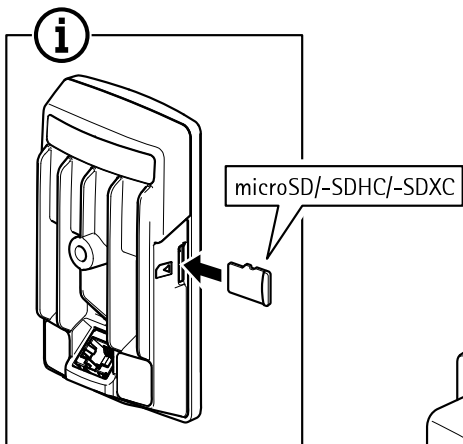

1.1

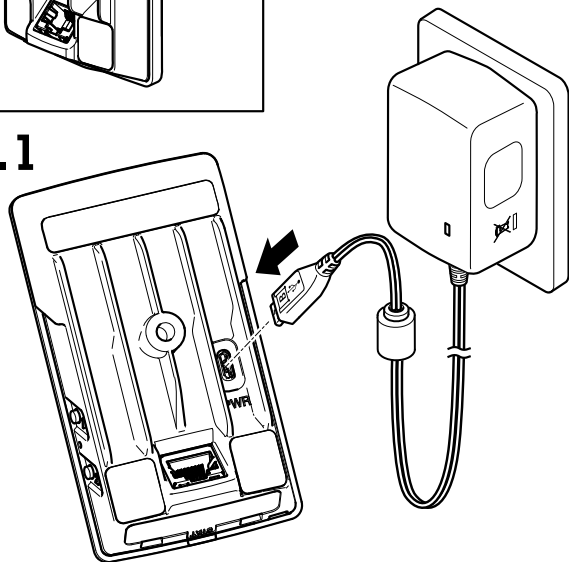

1.2

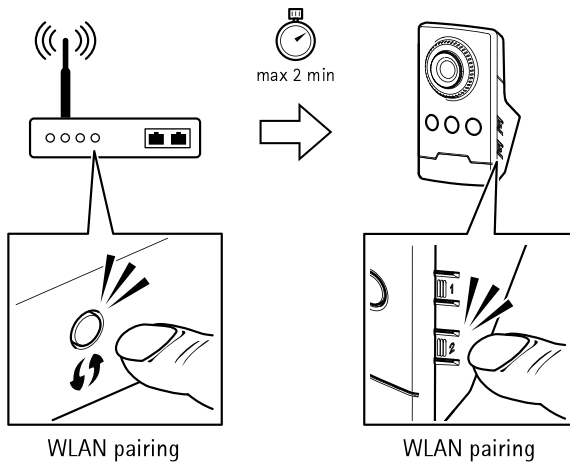

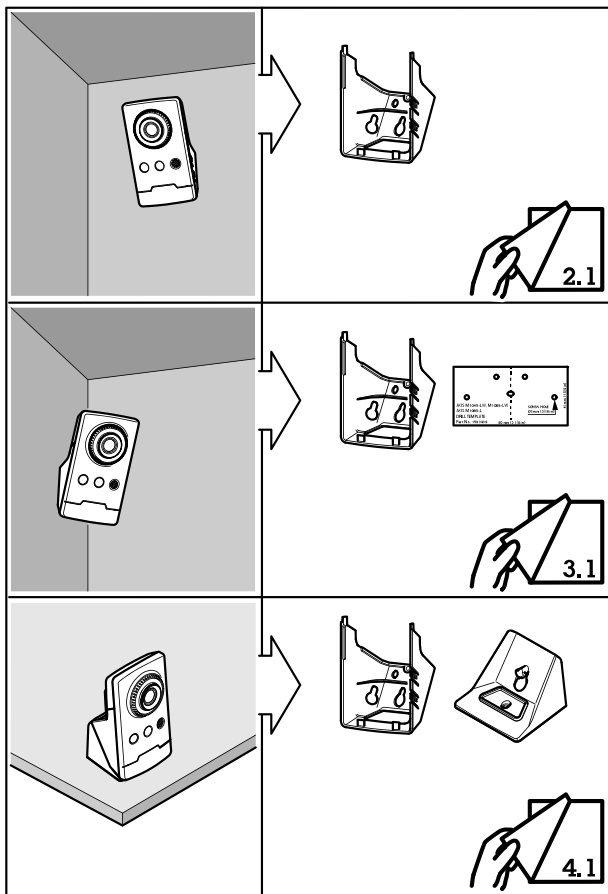

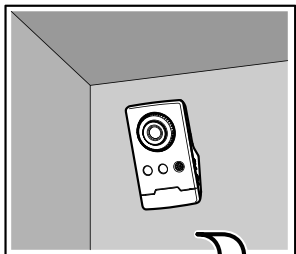

2.1

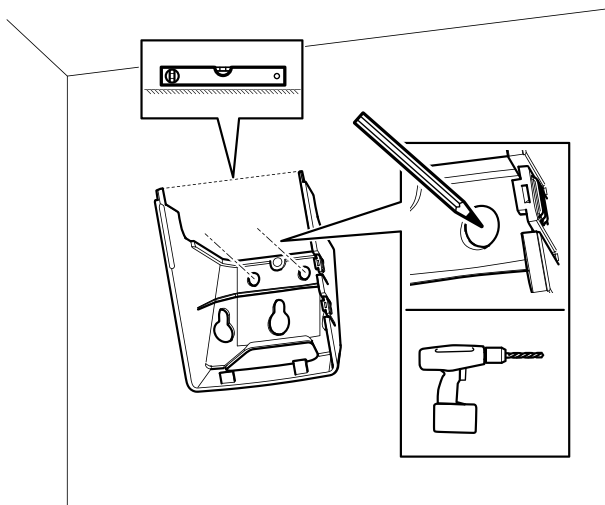

2.2

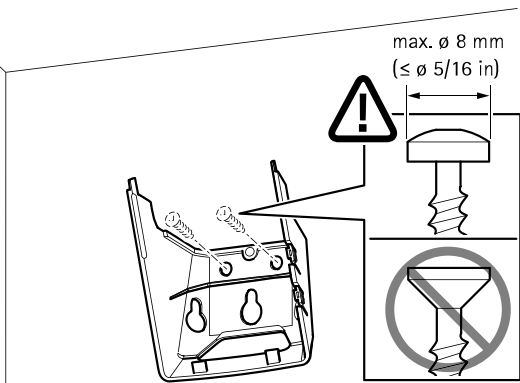

2.3

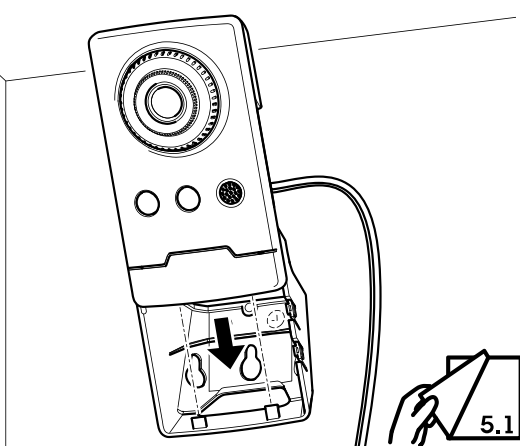

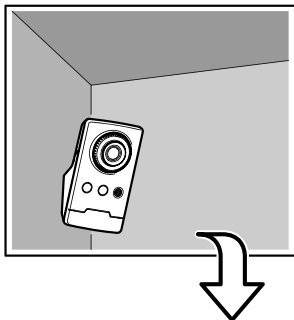

3.1

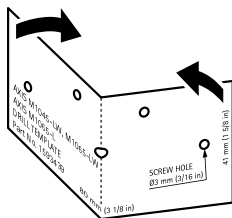
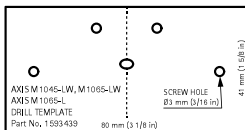

3.2

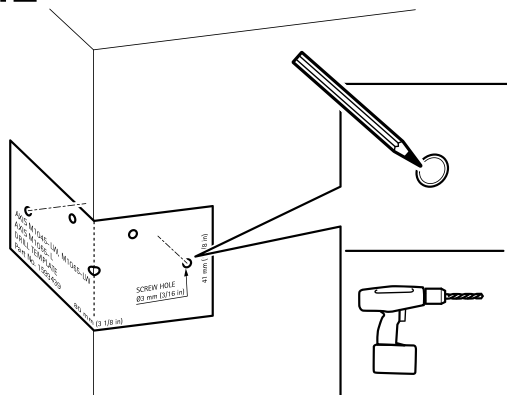

3.3

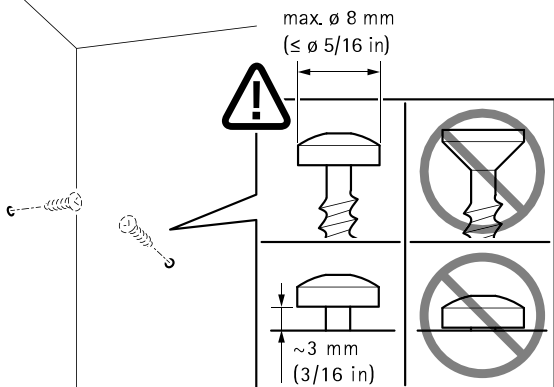

3.4

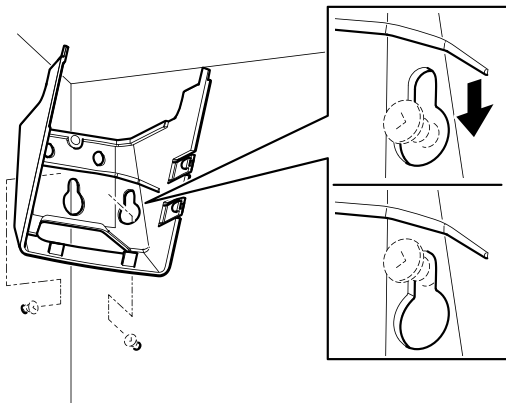

3.5

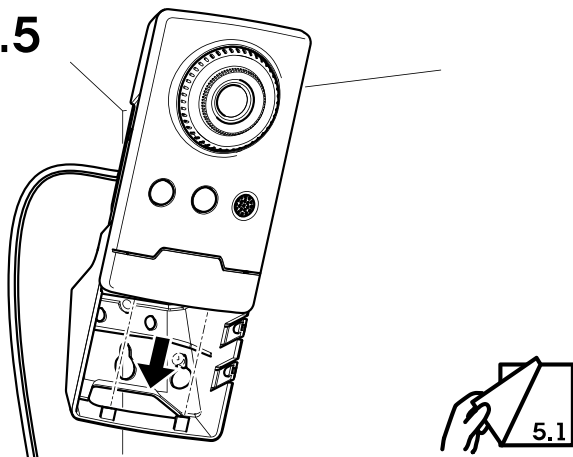

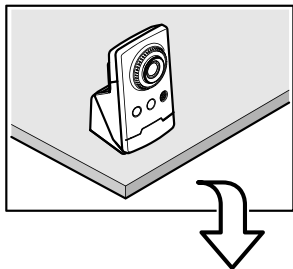

4.1

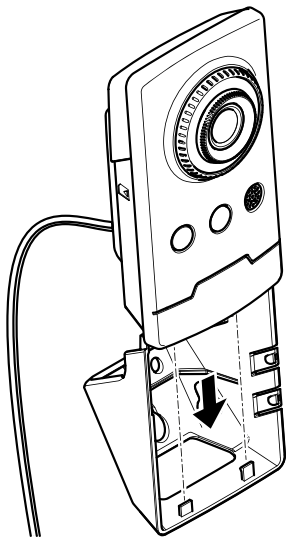

4.2

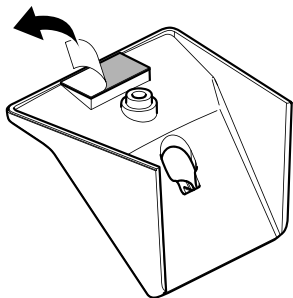

4.3

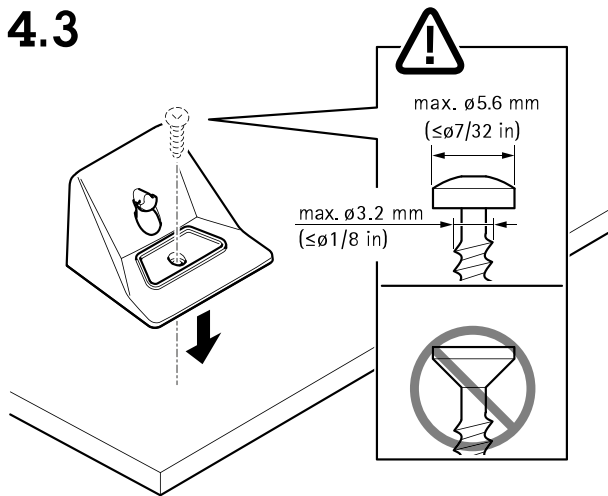

4.4

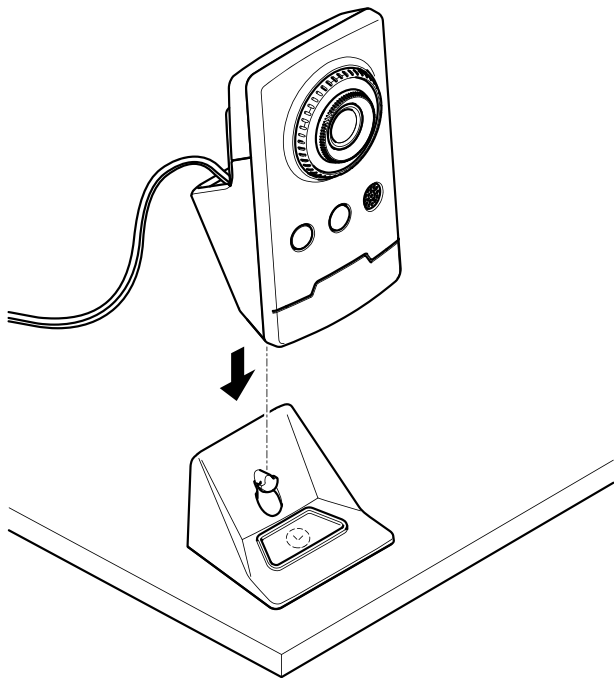

5.1

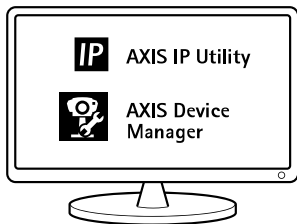

Installation Guide

AXIS M10 Network Camera Series

© 2016 - 2022 Axis Communications AB

Ver. M9.1

Date: August 2022

Part No. 2408923