





Wall mount bracket for multi-sensor vari-focal cameras

DWC-PV20WMW

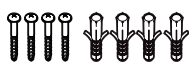
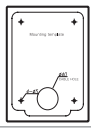

WHAT'S IN THE BOX

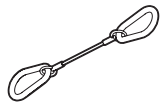
Camera Mounting Screws		2	Star Wrench (T20)		1
Screws and Plastic Anchors		4	Mounting Template		1
Hexagonal Wrench		1	Quick Setup Guide		1
Safety Wire		1			

NOTE: Download all your support materials and tools in one place.

1. Go to: <http://www.digital-watchdog.com/resources>
2. Search your product by entering the part number in the **'Search by Product'** search bar. Results for applicable part numbers will populate automatically based on the part number you enter.
3. Click **'Search'**. All supported materials, including manuals and quick start guide (QSGs) will appear in the results.



INSTALLATION

- 1 Using the mounting template or the mounting bracket's junction box itself, mark and drill the necessary holes on the mounting surface.
- 2 Secure the mounting bracket to the mounting surface using the screws and anchors that were included with the mount.
- 3 Using the T20 star wrench that was included, open the junction box part of the mounting accessory.
- 4 Pass wires through the junction box's neck.
- 5 Connect the wall mount's base into the neck, and secure using the screws on the side of the neck. Use the hexagonal wrench to secure the screws in place.
- 6 Affix the safety wire at the bottom of the mounting bracket's base. Connect the other side of the safety wire to the base of the camera.
- 7 To mount the camera to the mounting accessory, remove the dome from the camera base using the wrench included with the camera.

NOTE: Do not touch the lenses when handling the camera modules.

- 8 Pass wires through and make all necessary connections.
- 9 Secure the camera to the mounting bracket using the included screws. Align the indented lines on the side of the camera with the lines on the mounting bracket as seen in the image below. Rotate the camera clockwise to lock it into position.

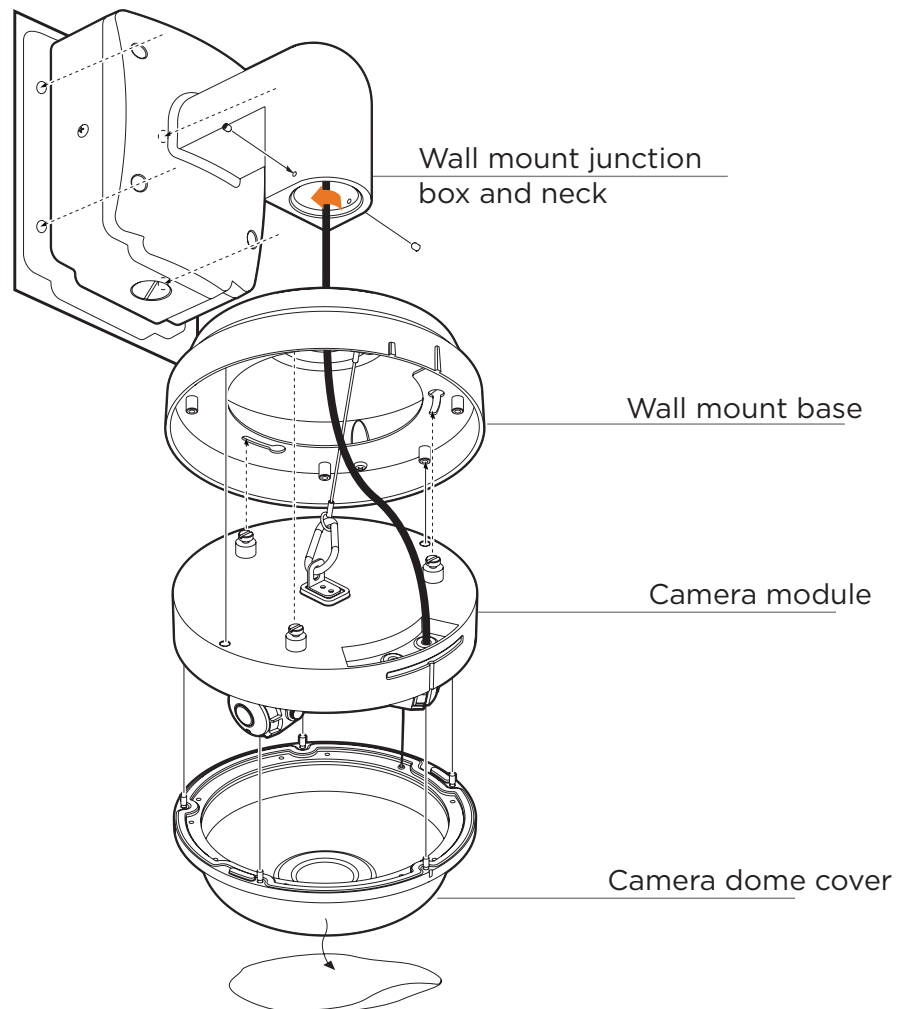

- 10 Adjust the camera modules' position and angle and complete the installation by placing the dome cover on the camera. Secure the dome cover to the camera base using the screws included with the camera. See the camera's QSG for more information.