

# TP-MED8M28

## 8MP HD IR Fixed Turret Network Camera



### KEY FEATURES

- ✓ 1/2.7" progressive scan CMOS
- ✓ Max. 8MP(3840×2160) @20fps resolution
- ✓ Turing cloud-ready with Smart NVR series and Turing bridge/servers
- ✓ Support 256 G microSD card
- ✓ Built-in Mic
- ✓ Smart IR, up to 30m
- ✓ IP67, WDR, PoE



# SPECIFICATIONS

CAMERA	
IMAGE SENSOR	1/2.7", 8.0 megapixel, progressive scan, CMOS
LENS	2.8mm@F2.0
ANGLE OF VIEW (H)	112.4 °
ADJUSTMENT ANGLE	Pan:3° ~ 360°, Tilt:0° ~ 80°, Rotate:3° ~ 360°
ELECTRONIC SHUTTER	Auto/Manual, 1 ~ 1/100000s
MINIMUM ILLUMINATION	Color: 0.01Lux (F2.0, AGC ON), 0Lux with IR
DAY/NIGHT	IR-cut filter with auto switch (ICR)
S/N RATIO	>56dB
IR RANGE	Up to 30m (98ft) IR range
IR WAVELENGTH	850nm
WIDE DYNAMIC RANGE	120 dB
VIDEO & AUDIO	
VIDEO COMPRESSION	Ultra 265, H.265, H.264, MJPEG
RESOLUTION & FRAME RATE	Main Stream: 8MP (3840*2160), Max 20fps; 5MP (3072*1728), Max 30fps; 4MP (2560*1440), Max 30fps; 1080P (1920*1080), Max 30fps; Sub Stream: 1080P (1920*1080), Max 30fps; 720P (1280*720), Max 30fps; D1 (720*576), Max 30fps; 640*360, Max 30fps; 2CIF(704*288), Max 30fps; CIF(352*288), Max 30fps; Third Stream: D1 (720*576), Max 30fps; 640*360, Max 30fps; 2CIF(704*288), Max 30fps; CIF(352*288), Max 30fps;
IMAGE ROTATION	Supported
WHITE BALANCE	Auto/Outdoor/Fine Tune/Sodium Lamp/Locked/Auto2
NOISE REDUCTION	2D/3D DNR
AUDIO COMPRESSION	G.711
AUDIO SAMPLING RATE	8KHZ
VIDEO INTELLIGENCE	Line crossing detection, Intrusion detection, enter area detection

INTERFACES	
LOCAL STORAGE	microSD, up to 256GB
AUDIO	Built-in Mic
NETWORK INTERFACE	1 RJ45 10M/100M Base-TX Ethernet
NETWORK PROTOCOLS	IPv4, IGMP, ICMP, ARP, TCP, UDP, DHCP, RTP, RTSP, RTCP, DNS, DDNS, NTP, FTP, UPnP, HTTP, SNMP, HTTPS, SMTP, SSL
3RD-PARTY COMPATIBILITY	ONVIF (Profile S, Profile G, Profile T), API
SUPPORTED BROWSER	Plug-in required live view: IE9+, Chrome 41 and below, Firefox 52 and below. Plug-in free live view: Chrome 57.0+, Firefox 58.0+, Edge 16+, Safari 11+

CERTIFICATIONS	
CERTIFICATIONS	CE: EN 60950-1 UL: UL60950-1 FCC: FCC Part 15

GENERAL	
POWER REQUIREMENT	DC 12V±25%, PoE (IEEE 802.3af)
POWER CONSUMPTION	Max 5.0W
DIMENSIONS	Φ110.5 x 94.1mm (Φ4.4" x 3.7")
NET WEIGHT	0.44kg (0.97lb)
MATERIAL	Metal
WORKING ENVIRONMENT	-30°C ~ 60°C (-22°F ~ 140°F), Humidity: =95% RH (non-condensing)
WATER PROTECTION	IP67

COMPATIBLE NVRs	
Turing Smart NVR series, including TR-MRP04(2T), TR-MRP08(2T), TR-MRP16(4T), TR-MR32R, and TR-MR64R	



## DIMENSIONS

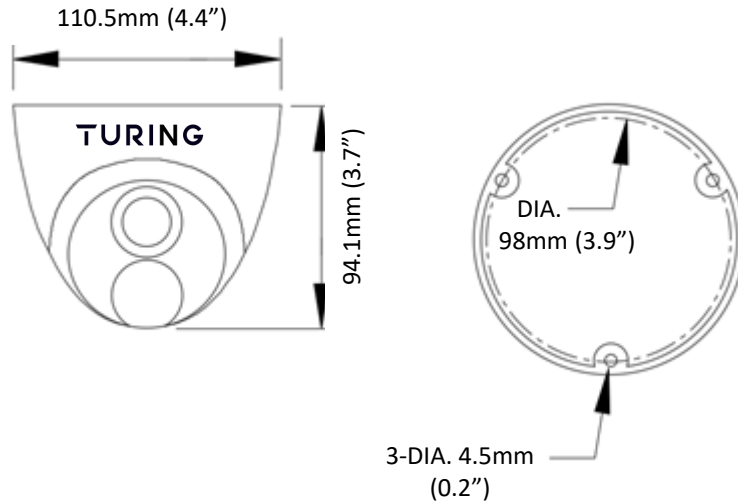

## MOUNTING

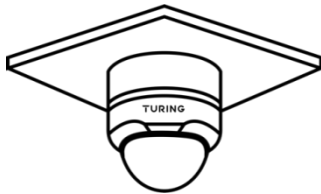

Junction Box: TP-EFDJB

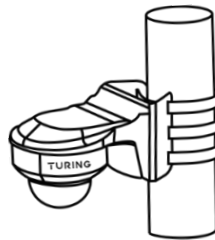

Pole Mount: TP-UDPM  
Wall Mount: TP-EFDWM  
WM w/ Junc. Box: TP-EFDWJ

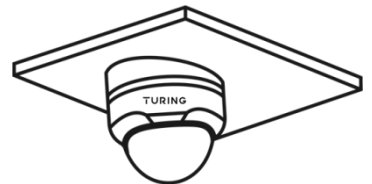

Tilt Mount: TP-EFDTM



Wall Mount: TP-EFDWM  
WM w/ Junction Box: TP-EFDWJ

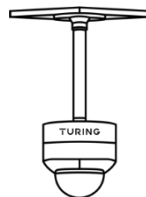

Pendant Mount: TP-AIPMB  
Junction Box: TP-EFDJB  
Optional Extensions:  
TP-IPME2 (9") &  
TP-IPME5 (22")

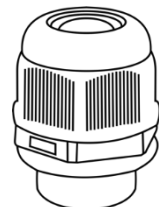

Optional Cable Gland:  
TP-UWPJ



# BETTER SAFETY, BETTER SECURITY WITH NEXT LEVEL AI

Turing AI's People Analytics provides better safety and security through utilizing Face Search\*, Person Attribute Search\*, Person History\*, and Person of Interest\* Alerts & Notifications.

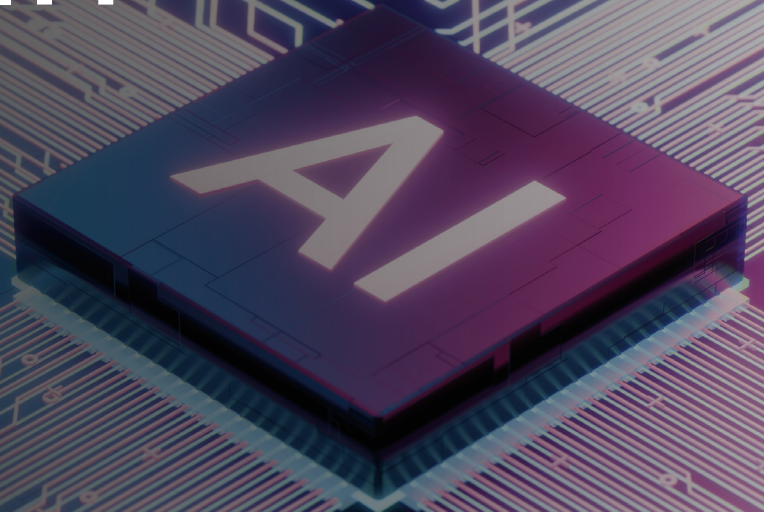

## Three Levels of AI

### LEVEL ONE: OBJECT DETECTION

Person

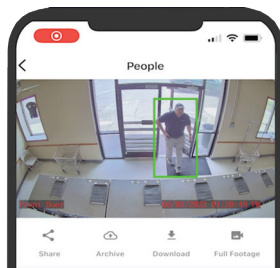

### LEVEL TWO: IDENTITY DETECTION

Tim S.

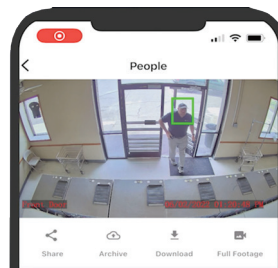

### LEVEL THREE: ATTRIBUTE DETECTION

Hat /  
Black Shirt /  
Grey Pants

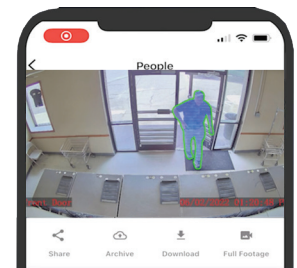

## TURING

Turing AI is committed to ensure its platform comply with applicable regulations. Activation depends on state regulations and the compliance with Biometric Information Protection Act (BIPA). Please refer to our [privacy policy](#), and [compliance availability](#).

\*Activation depends on state regulations and the compliance with Biometric Information Protection Act (BIPA). Please refer to our [privacy policy](#).

Visit our website to learn more at [turing.ai](https://turing.ai)

# Simplify Your Security Workflow with Award-Winning AI

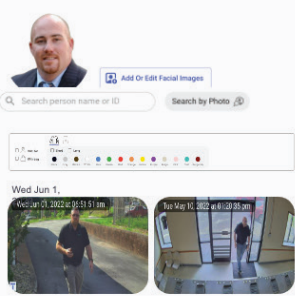

**Identity Search uses Name, ID and Face**

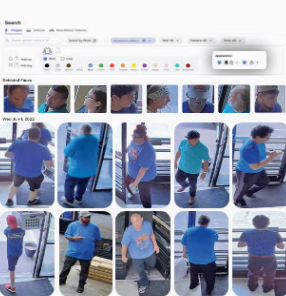

**Find People that Match Selected Attributes**

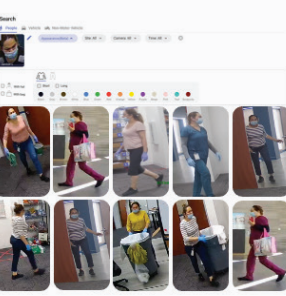

**View all people that have been captured to speed up investigations**

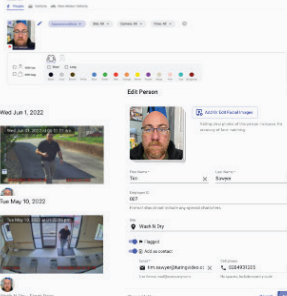

**Intelligent alert based on person and vehicle of interest**

## Privacy

Turing AI's People Analytics solution is built with optimal safety and security. Any historical data your system collects is encrypted and securely stored within your organization.

Turing AI provides customers complete control over their Turing Vision Platform. Face Search\* and People Attribute Search\* takes administrative approval to be activated. Face Search\* is not available and may not be used in the States of Illinois, Texas, or Washington. By enabling Face Search\*, I agree not to use Face Search\* in Illinois, Texas or Washington. If I do use Face Search\* in Illinois, Texas or Washington, I agree to indemnify and hold harmless Turing for any claims or liability arising from or related to my use of Face Search\* in Illinois, Texas, or Washington. I further acknowledge that the data generated by Face Search\* may be subject to certain Data Protection Laws and Biometric Privacy Laws and agree that I will comply with all applicable Data Protection Laws and Biometric Privacy Laws relating to the deployment and use of Face Search\*.

Data Protection Laws include, without limitation, (i) the California Consumer Privacy Act of 2018 (CCPA), as amended and replaced by the California Privacy Rights Act of 2020, (ii) the Virginia Consumer Data Protection Act (VCDPA), (iii) the Colorado Privacy Act (CPA), (iv) the Connecticut Data Privacy Act (CTDPA), (v) the Utah Consumer Privacy Act (UCPA), (vi) the Canada Personal Information and Electronic Documents Act (PIPEDA), (vii) the Alberta Personal Information Protection Act (Alberta PIPA), (viii) the British Columbia Personal Information Protection Act (BC PIPA), (ix) the Quebec Act Respecting the Protection of Personal Information in the Private Sector, (x) the Quebec Information Technology Act and (xi) such other comprehensive data protection laws that may be enacted and during my use of the services and would apply to my use of the services. Biometric Privacy Laws include, without limitation, (i) the Illinois Biometric Information Privacy Act (BIPA), (ii) Washington statute RCW 19.375, (iii) the Texas Capture or Use of Biometric Identifiers (CUBI), (iv) New York City Admin. Code § 22-1201 and (v) such other biometric privacy laws that may be enacted during my use of the services and would apply to my use of the services.

## Compliance and Availability

Turing AI is committed to ensure its platform comply with applicable regulations. The following features are not available in the jurisdiction listed in the table below.

Jurisdiction	Face Search	Person of Interest Notifications
Illinois	X	X
Texas	X	X
Washington	X	X
Baltimore	X	X
Portland	X	X

## TURING

Turing AI is committed to ensure its platform comply with applicable regulations. Activation depends on state regulations and the compliance with Biometric Information Protection Act (BIPA). Please refer to our [privacy policy](#), and [compliance availability](#).

\*Activation depends on state regulations and the compliance with Biometric Information Protection Act (BIPA). Please refer to our [privacy policy](#).

Visit our website to learn more at [turing.ai](https://turing.ai)

# TRANSFORM YOUR SAFETY, SECURITY, AND OPERATIONS

A SMART FLEXIBLE CLOUD-BASED VIDEO SECURITY PLATFORM

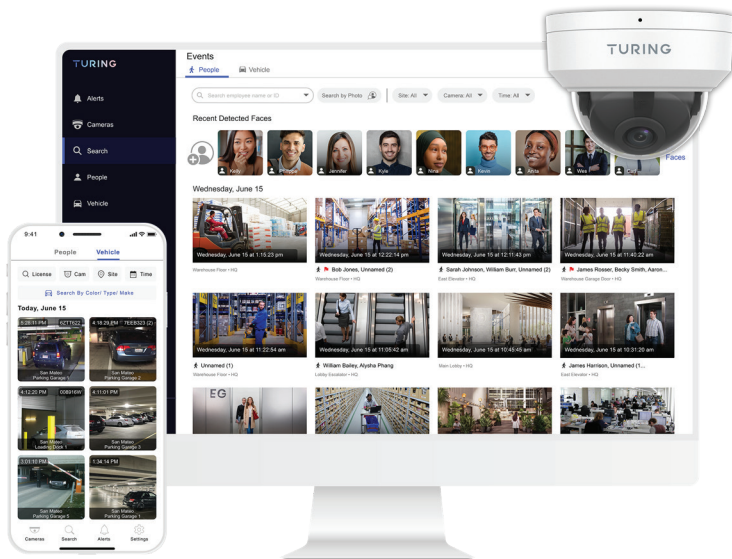

Turing Vision is the industry-leading safety and security video platform. Turing Vision's AI-enabled, cloud-based platform allows you to search, be alerted, and analyze detection patterns across multiple locations. Turing Vision allows you to improve operational efficiencies, increase safety, and get the most out of your camera infrastructure investments.



Find, Capture, and  
Send Security Clips  
in Seconds

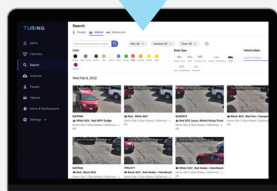

CLICK TO VIEW VIDEO

Easily Access Multiple  
Sites from Anywhere  
and on Any Device

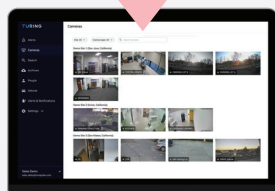

CLICK TO VIEW VIDEO

Flexible Integration  
with New and  
Existing IP Cameras

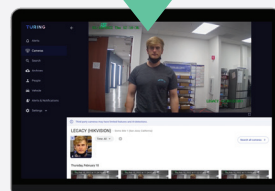

CLICK TO VIEW VIDEO

Manage and Upgrade  
Your Systems and  
Firmware Remotely

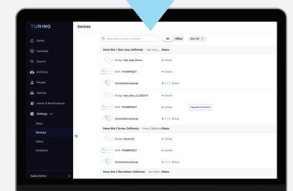

CLICK TO VIEW VIDEO

TURING

Visit our website to learn more at [turing.ai](https://turing.ai)

# TURING VISION CORE AI LICENSE

CORE FEATURES	SMART SERIES
<b>FAST AND EASY SECURITY WORKFLOW</b>	
Live view and replay camera recording from anywhere*	✓
Smart Alert: Setup alerts based on one or more face recognition, flagged or specific license plates, or specific vehicle attributes like colors, make, body type.	✓
Basic Alert: Alerts when vehicles or people are detected to text message, email and/or mobile push notifications.*	✓
Cloud Archive: archive important detection event video clips or snapshot indefinitely in the cloud.	✓
Share alert, event and archive with law enforcement, legal investigation, insurance and virtually anyone instantly.	✓
<b>CLOUD-BASED DEVICE MANAGEMENT</b>	
Bridge and NVR Management, OTA Firmware Upgrade / Remote Restart from anywhere*	✓
OTA Camera Firmware Upgrade, setup detection region and edit camera settings from anywhere	✓
System Dashboard: Camera and Device status	✓
<b>ADVANCED AI</b>	
Face Search: Search person events by uploading a photo with a face, or by a recently detected face. Flag or name detected faces for future alerts. Preload faces for flagging and alerts. <sup>1</sup>	✓
Person Attribute Search <sup>**</sup> : Search person events by the color of the attire, long/short sleeves, gender, items like hat or bag.	✓
Vehicle Attribute Search: Search by vehicle color, make and body type	✓
Vehicle License Plate Search: Search by license plate number. Flag detected license plates for future alerts. Set up Vehicle License Plate Database for customizing Smart alert (alert and do not alert list).	✓
Non-Motor Vehicle: Search events with non-motor wheeled objects	✓
<b>WARRANTY</b>	
Turing AI warranty covers hardware with active CORE AI licenses. <sup>***</sup>	✓

## Multi-Year License Subscription

DURATION	CORE AI	WARRANTY <sup>***</sup>	DURATION	CORE AI	WARRANTY <sup>***</sup>
1 YEAR CORE	✓	✓	5 YEAR CORE	✓	✓
3 YEAR CORE	✓	✓	10 YEAR CORE	✓	✓



\*Included in the Basic Subscription

\*\*Upcoming features

\*\*\*Warranty included and covers hardware with active CORE AI licenses

<sup>1</sup>Activation depends on state regulations and the compliance with Biometric Information Protection Act (BIPA).

Please refer to our privacy policy.