

## GV-EBFC5800 AI 5MP H.265 Super Low Lux WDR Pro Full Color Warm LED Eyeball Dome IP Camera



- AI deep learning: AI Perimeter Protection & Classification (Human, Vehicle)
- 1/2.7" progressive scan CMOS sensor
- Triple streams from H.265, H.264 or MJPEG
- Min. illumination at 0.001 lux
- Up to 30 fps at 2880 x 1620
- Full color smart warm LEDs distance up to 30 m (100 ft)
- Wide Dynamic Range Pro (WDR Pro)
- Built-in microphone
- Built-in micro SD card slot (SD / SDHC / SDXC / UHS-I) for local storage
- 3-axis mechanism (pan / tilt / rotate)
- Ingress protection (IP67)
- DC 12V / PoE (IEEE 802.3af)
- Defog
- 3D noise reduction
- AI analytics (Intrusion, Cross Line, Enter Area, Leave Area, Face Detection, People Flow Counting, Crowd Density Monitoring)
- Motion detection
- Tampering alarm
- Text overlay
- Privacy mask
- 12 languages supported
- ONVIF (Profile G, S, T) conformant

### Introduction

The Eyeball Dome IP Camera is an outdoor, network camera equipped with smart warm LEDs for full color surveillance. The camera supports H.265 video codec to achieve better compression ratio while maintaining high quality pictures at reduced network bandwidths. GV-EBFC5800 adheres to IP67 standards, and can be powered through PoE.

Empowered by deep learning algorithms, AI technology distinguishes human and vehicles from other moving objects. Integrated with GeoVision Video Management Software (VMS), it supports AI perimeter protection, real time alert, events playback and more.

### Deep Learning Function

#### Face Detection

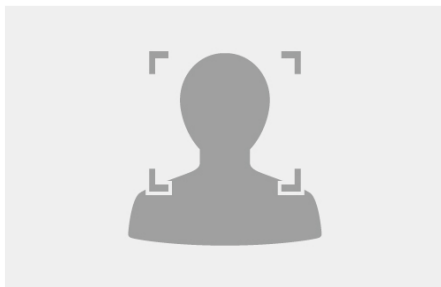

#### AI Perimeter Protection

(Intrusion, Cross Line  
Enter Area, Leave Area)

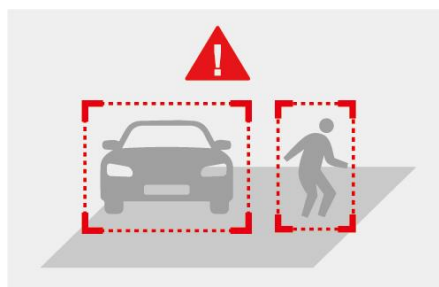

#### People Flow Counting

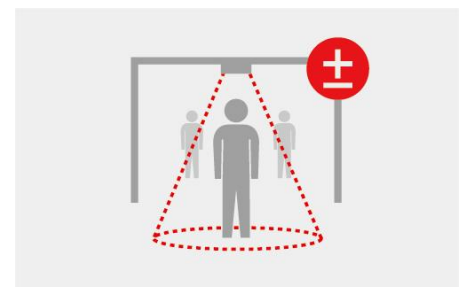

**Note:** People Flow Counting and Crowd Density Monitoring integration of the camera to GV-VMS is coming soon.

## Dimensions

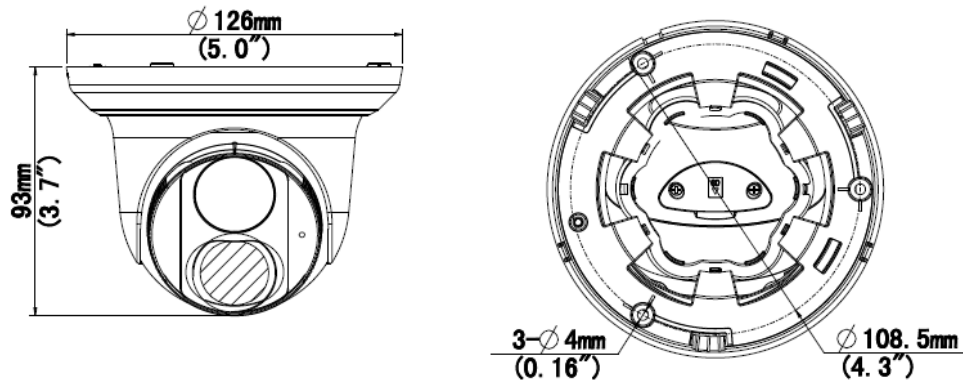

## Specifications









Camera		
Image Sensor	1/2.7" progressive scan CMOS	
Picture Elements	2880 (H) x 1620 (V)	
Minimum Illumination	Color	0.001 Lux (F1.0, AGC ON)
Shutter Speed	Automatic / Manual (1 ~ 1/100000 sec)	
White Balance	Automatic, Manual	
Gain Control	Automatic, Manual	
S/N Ratio	56 dB	
WDR	WDR Pro	
Dynamic Range	120 dB	
Lens		
Megapixel	5 MP	
Day / Night	Color	
Lens Type	Fixed	
Focal Length	2.8 mm	
Maximum Aperture	F/1.0	
Mount	M12	
Horizontal FOV	102°	
Operation	Focus	Fixed
	Zoom	Fixed
	Iris	Fixed
Smart Illumination	LED Quantity	2 Warm LEDs
	Max. IR Distance	30 m (100 ft)
Operation		
Video Compression	H.265, H.264, MJPEG	
Video Streaming	Triple streams from H.265, H.264 or MJPEG	
Video Resolution	Main Stream	2880 x 1620 (Default), 2560 x 1440, 2304 x 1296, 1920 x 1080, 1280 x 720
	Sub Stream	1280 x 720, 720 x 576 (Default), 704 x 288, 640 x 480, 640 x 360, 352 x 288
	Third Stream (Closed by Default)	720 x 576, 640 x 360, 706 x 288, 352 x 288
Frame Rate	30 fps at 2880 x 1620, 30 fps at 2560 x 1440, 30 fps at 2304 x 1296, 30 fps at 1920 x 1080, 30 fps at 1280 x 720, 30 fps at 720 x 576, 30 fps at 704 x 288, 30 fps at 640 x 480, 30 fps at 640 x 360, 30 fps at 352 x 288 (60 / 50 Hz) *The frame rate and performance may vary depending on the number of connections and data bitrates (different scenes).	
Video Analytics	Motion Detection, Tampering Alarm, Audio Detection. *Tampering alarm and Audio detection are only accessible through the camera's Web interface, which can be used to trigger alerts such as e-mail and FTP	
Image Setting	Brightness, Contrast, Saturation, Sharpness, Flicker-less, 3D Noise Reduction, Image Orientation (Flip, Mirror, 0°, 90°, 180°, 270°-including Corridor format),	

Audio Compression	G.711	
Audio Support	One-way Audio	
<b>Network</b>		
Interface	10/100 Ethernet	
Protocol	802.1x, ARP, DHCP, DDNS, DNS, DynDNS, FTP, HTTP, HTTPS, ICMP, IGMP, IPv4, NTP, PPPoE, QoS, RTCP, RTP, RTSP, SMTP, SNMP, TCP, UDP, UPnP, ONVIF (Profile G, S, T), API	
<b>Deep Learning Function</b>		
AI Perimeter Protection	Intrusion, Cross Line, Enter Area, Leave Area (Human & Vehicle classification), Face Detection, People Flow Counting, Crowd Density Monitoring	
<b>Mechanical</b>		
Camera Angle Adjustment	Pan	3° ~ 360°
	Tilt	0° ~ 80°
	Rotate	3° ~ 360°
Connectors	Power	DC 12V, PoE (IEEE 802.3af)
	Ethernet	RJ-45
	Audio	1 In (Built-in microphone)
	Local Storage	Micro SD card slot (SD/SDHC/SDXC/UHS-I, Class 10) *UHS-II card type is not supported.
<b>General</b>		
Environment Temperature	Start-up	-30°C ~ 60°C (-22°F ~ 140°F)
	Operation	
Humidity	0% ~ 95% (no condensation)	
Power Source	DC 12V / PoE (IEEE802.3af)	
Max. Power Consumption	7.5W	
Dimensions	Ø 126 x 93 mm (Ø 5" x 3.7")	
Weight	0.44 kg (0.97 lb)	
Ingress Protection	IP67	
Regulatory	CE, FCC, RoHS compliant	
<b>Web Interface</b>		
Installation Management	Web-based configuration	
Maintenance	Firmware upgrade through Web Browser or Utility	
Access from Web Browser	Live View, Video Recording, Change Video Quality, Bandwidth Control, Image Snapshot, Text Overlay, Image Masking	
Language	Czech, English, French, German, Hungarian, Italian, Japanese, Polish, Portuguese, Russian, Spanish, Traditional Chinese	
<b>Software Applications</b>		
Software Supported	GV-DVR / NVR (V8.9.1), GV-VMS (V17.4.4 / V18.2.1), GV-Control Center (V3.8.0 / V4.0.1), GV-Edge Recording Manager Windows Version (V2.0.0), GV-Recording Server / Video Gateway (V2.0.1), GV-Redundant / Failover Server (V1.2.0), GV-Mobile Server (V1.5.1), GV-AI Guard (V1.0.0)	
Live Viewing	Browser (IE, Edge, Chrome, Firefox, Safari), Mobile App	

### Packing List

1. GV-EBFC5800 Eyeball Dome
2. Waterproof Rubber Set
3. Screw kit
4. Drill Template Paster
5. Download Guide

## Accessories

Model No.	Name		Details
GV-Mount107(must be used with GV-Mount212P)	Pendant Bracket		Dimensions: $\varnothing$ 120 x 334 mm ( $\varnothing$ 4.72" x 13.15") Weight: 0.74 kg (1.63 lb)
GV-Mount211P	Wall Mount and Junction Box		Dimensions: $\varnothing$ 233 x 125 x 125 mm ( $\varnothing$ 9.2" x 4.9" x 4.9") Weight: 1 kg (2.2 lb)
GV-Mount212P	Wall Box Mount		Dimensions: $\varnothing$ 126 x 36 mm ( $\varnothing$ 5.0" x 1.4") Weight: 0.22 kg (0.48 lb)
GV-Mount300-2	Convex Corner Mount		Dimensions: 137 x 233 x 160 mm (5.4" x 9.17" x 6.3") Weight: 1.65 kg (3.64 lb)
GV-Mount310-2	Concave Corner Mount		Dimensions: 111.2 x 369.9 x 210 mm (2.6" x 11.4" x 6.6") Weight: 1.65 kg (3.64 lb)
GV-Mount420 (must be used with GV-Mount211P)	Pole Mount Bracket		Dimensions: $\varnothing$ 120 x 120 x 53.4 mm ( $\varnothing$ 4.7" x 4.7" x 2.1") Weight: 0.45 kg (0.99 lb) Steel Strap Diameter: $\varnothing$ 67 ~ 127 mm ( $\varnothing$ 2.6" ~ 5")
GV-Mount704 (must be used with GV-Mount107)	Extension Tube		Dimensions: $\varnothing$ 3.5 x 10 or 20 or 30 or 50 cm ( $\varnothing$ 1.38" x 3.9" or 7.9" or 11.8" or 19.7") Weight: 225 g or 360 g or 500 g or 780 g (0.5 lb or 0.79 lb or 1.1 lb or 1.72 lb)
GV-PA191	Power over Ethernet (PoE) Adapter		The GV-PA191 is a Power over Ethernet (PoE) adapter designed to provide power to the IP device through a single Ethernet cable.
GV-POE Switch			The GV-POE Switch is designed to provide power along with network connection for IP devices. The GV-POE Switch is available in various models with different numbers and types of ports.
Power Adapter			Contact our sales representatives for the countries and areas supported.