

# GV-EBD4813 AI 4MP H.265 5x Zoom Super Low Lux WDR Pro IR Eyeball Dome IP

## Camera



- AI deep learning: AI Perimeter Protection & Classification (Human, Vehicle)
- 1/3" progressive scan super low lux CMOS sensor
- Triple streams from H.265, H.264 or MJPEG
- Wide Dynamic Range Pro (WDR Pro)
- Min. illumination at 0.002 lux
- Up to 30 fps at 2688 x 1520
- Intelligent IR
- Day and night function (with removable IR-cut filter)
- Motorized lens for remote focus/zoom adjustment
- IR distance up to 40 m (130 ft)
- Built-in microphone
- Built-in micro SD card slot (SD / SDHC / SDXC / UHS-I) for local storage
- 3-axis mechanism (pan / tilt / rotate)
- Ingress protection (IP67)
- Vandal resistance (IK10 for metal casing)
- DC 12V / PoE (IEEE 802.3af)
- ONVIF (Profile G, S, T) conformant



## Introduction

GV-EBD4813 is an outdoor, network camera equipped with an automatic IR-cut filter and IR LEDs for day and night surveillance. The camera supports H.265 video codec to achieve better compression ratio while maintaining high quality pictures at reduced network bandwidths. The camera adheres to IK10 and IP67 standards, and can be powered through PoE.

Empowered by deep learning algorithms, AI technology distinguishes human and vehicles from other moving objects. Integrated with GeoVision Video Management Software (VMS), it supports AI perimeter protection, real time alert, events playback and more.

## Deep Learning Function

### Face Detection

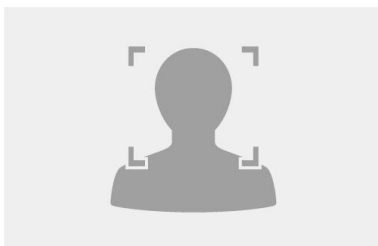

### AI Perimeter Protection

(Intrusion, Crossing Line  
Entering Area, Leaving Area)

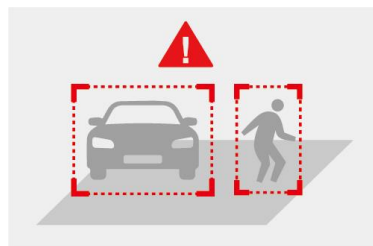

### People Counting

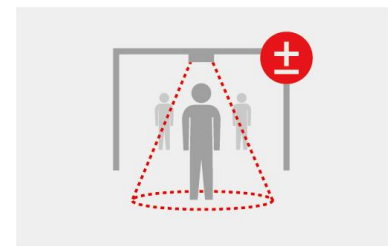

**Note:** The integration of AI events of the camera to GV-VMS is coming soon.

## Dimensions

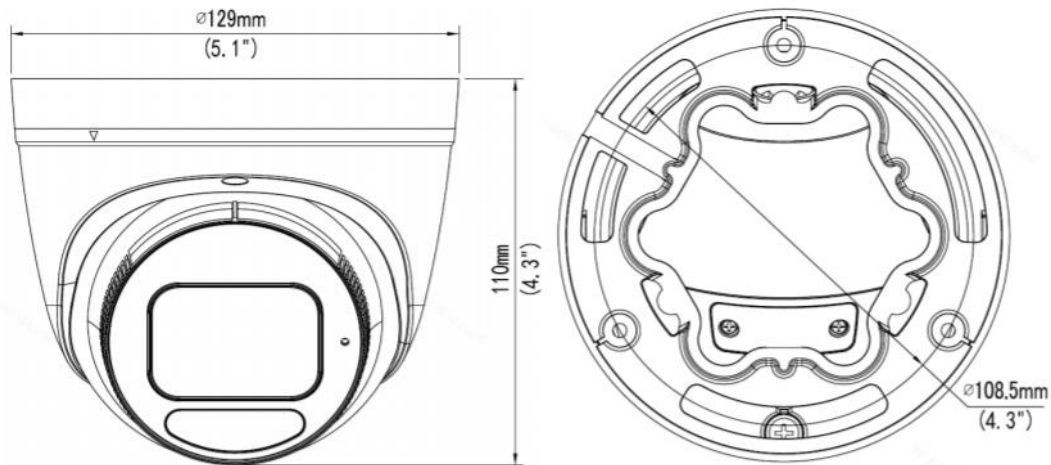

## Specifications

### Camera

Image Sensor	1/3" progressive scan super low lux CMOS	
Picture Elements	2688 (H) x 1520 (V)	
Minimum Illumination	Color	0.002 Lux (F1.2, AGC ON)
	IR ON	0 Lux
Shutter Speed	Automatic / Manual (1 ~ 1/100000 sec)	
White Balance	Automatic, Manual	
Gain Control	Automatic, Manual	
S/N Ratio	56 dB	
WDR	WDR Pro	
Dynamic Range	120 dB	

### Lens

Megapixel	4 MP	
Day / Night	Yes (with removable IR-cut filter)	
Lens Type	Motorized varifocal lens	
Focal Length	2.7 ~ 13.5 mm	
Maximum Aperture	F/1.2	
Mount	Ø 12 mm	
Horizontal FOV	98°~31°	
Operation	Focus	Auto / Manual
	Zoom	5x Optical Zoom
	Iris	Fixed
IR LED Quantity	2 IR LEDs	
Max. IR Distance	40 m (130 ft)	

### Operation

Video Compression	H.265, H.264, MJPEG
Video Streaming	Triple streams from H.265, H.264 or MJPEG
Frame Rate	30 fps at 2688 x 1520, 30 fps at 2560 x 1440, 30 fps at 2304 x 1296 (60 / 50 Hz) *The frame rate and performance may vary depending on the number of connections and data bitrates (different scenes).
Video Analytics	Motion Detection, Tampering Alarm, Audio Detection. *Tampering alarm and Audio detection are only accessible through the camera's Web interface, which can be used to trigger alerts such as e-mail and FTP
Image Setting	Brightness, Contrast, Saturation, Sharpness, Flicker-less, 3D Noise Reduction, Image Orientation (Flip, Mirror, 0°, 90°, 180°, 270°-including Corridor format)
Audio Compression	G.711
Audio Support	One-way Audio

Face Detection		
Environment		100 lux
Detectable face angle	Tilt (Up/Down)	≤ 10°
	Swing (Left/Right)	≤ 30°
Max. number of faces		Up to 40
Min. face image pixel requirement		80 pixels
Deep Learning Function		
AI Analytics		Intrusion, Crossing Line, Entering Area, Face Detection, Leaving Area (Human & Vehicle classification), People Flow Counting, Crowd Density Monitoring
Video Resolution		
Main Stream		2688 x 1520 (Default), 2560 x 1440, 2304 x 1296, 1920 x 1080, 1280 x 720
Sub Stream		1280 x 720, 720 x 576, 704 x 288, 640 x 360 (Default), 640 x 480, 352 x 288
Third Stream (Closed by Default)		720 x 576, 704 x 288, 640 x 360, 352 x 288
Network		
Interface		10/100 Ethernet
Protocol		802.1x, ARP, DHCP, DDNS, DNS, DynDNS, FTP, HTTP, HTTPS, ICMP, IGMP, IPv4, NTP, PPPoE, Qos, RTCP, RTP, RTSP, SMTP, SNMP, TCP, UDP, UPnP, ONVIF (Profile G, S, T)
Mechanical		
Camera Angle Adjustment	Pan	0° ~ 360°
	Tilt	0° ~ 75°
	Rotate	0° ~ 360°
Connectors	Power	DC Jack (DC 12V, 1.25A), PoE
	Ethernet	RJ-45
	Audio	1 In (built-in microphone)
	Local Storage	Micro SD card slot (SD/SDHC/SDXC/UHS-I, Class 10) *UHS-II card type is not supported.
General		
Environment Temperature	Start-up	-30°C ~ 60°C (-22°F ~ 140°F)
	Operation	
Humidity		0% ~ 95% (no condensation)
Power Source		12V DC / PoE (IEEE802.3af)
Max. Power Consumption		7.0W
Dimensions		∅ 129 x 110 mm (∅ 5.1" x 4.3")
Weight		0.69 kg (1.52 lb)
Ingress Protection		IP67
Vandal Resistance		IK10 for metal casing
Regulatory		CE, FCC, RoHS
Web Interface		
Installation Management		Web-based configuration
Maintenance		Firmware upgrade through Web Browser or GV-IP Device Utility
Access from Web Browser		Live View, Video Recording, Change Video Quality, Bandwidth Control, Image Snapshot, Defog, Digital Zoom, Text Overlay, Image Masking
Language		Czech, English, French, German, Hungarian, Italian, Japanese, Polish, Portuguese, Russian, Spanish, Traditional Chinese
Applications		
Software Supported		GV-VMS (V17.4.2 / V18.2.1), GV-DVR / NVR (V8.9.1), GV-Control Center (V3.8.0), GV-Recording Server / Video Gateway (V2.0.0), GV-Edge Recording Manager Win version (V2.0.0), GV-Redundant / Failover Server (V1.2.0), GV-Mobile Server (V1.5.1)
Smart Device Access		GV-Eye for iOS and Android
Live Viewing		Browser (IE, Edge, Chrome, Firefox, Safari), Mobile App









**Note:**

1. Patch files are required for some supported software.
2. Do not use clothes or any ordinary material to clean the camera cover since they may result in scratches.
3. Specifications are subject to change without notice.

## Packing List

1. GV-EBD4813 Eyeball Dome
2. Waterproof Rubber Set
3. Screw kit
4. Drill Template Paster
5. Download Guide

## Accessories

Model No.	Name		Details
GV-Mount107(must be used with GV-Mount212P)	Pendant Bracket		Dimensions: Ø 120 x 334 mm (Ø 4.72" x 13.15") Weight: 0.74 kg (1.63 lb)
GV-Mount211P	Wall Mount and Junction Box		Dimensions: Ø 233 x 125 x 125 mm (Ø 9.2" x 4.9" x 4.9") Weight: 1 kg (2.2 lb)
GV-Mount212P	Wall Box Mount		Dimensions: Ø 126 x 36 mm (Ø 5.0" x 1.4") Weight: 0.22 kg (0.48 lb)
GV-Mount300-2	Convex Corner Mount		Dimensions: 137 x 233 x 160 mm (5.4" x 9.17" x 6.3") Weight: 1.65 kg (3.64 lb)
GV-Mount310-2	Concave Corner Mount		Dimensions: 111.2 x 369.9 x 210 mm (2.6" x 11.4" x 6.6") Weight: 1.65 kg (3.64 lb)
GV-Mount420 (must be used with GV-Mount211P)	Pole Mount Bracket		Dimensions: Ø 120 x 120 x 53.4 mm (Ø 4.7" x 4.7" x 2.1") Weight: 0.45 kg (0.99 lb) Steel Strap Diameter: Ø 67 ~ 127 mm (Ø 2.6" ~ 5")
GV-Mount704 (must be used with GV-Mount107)	Extension Tube		Dimensions: Ø 3.5 x 10 or 20 or 30 or 50 cm (Ø 1.38" x 3.9" or 7.9" or 11.8" or 19.7") Weight: 225 g or 360 g or 500 g or 780 g (0.5 lb or 0.79 lb or 1.1 lb or 1.72 lb)
GV-PA191	Power over Ethernet (PoE) Adapter		The GV-PA191 is a Power over Ethernet (PoE) adapter designed to provide power to the IP device through a single Ethernet cable.
GV-POE Switch			The GV-POE Switch is designed to provide power along with network connection for IP devices. The GV-POE Switch is available in various models with different numbers and types of ports.
Power Adapter			Contact our sales representatives for the countries and areas supported.