

GV-SD4825-IR AI 4MP 25x Zoom H.265 Super Low Lux WDR Pro Outdoor IR IP

Speed Dome



- AI deep learning: AI Perimeter Protection & Classification (Human, Vehicle)
- 1/2.8" progressive scan CMOS sensor
- Min. illumination at 0.003 lux
- Triple streams from H.265, H.264 or MJPEG
- Up to 30 fps at 2688 x 1520
- Motorized varifocal lens for remote focus / zoom adjustments
- 25x optical zoom and unlimited digital zoom
- Intelligent IR
- IR distance up to 100 m (330 ft)
- Day and night function (with removable IR-cut filter)
- Two sensor inputs and one alarm output
- Wide Dynamic Range Pro (WDR Pro)
- Ingress protection (IP67)
- Vandal resistance (IK10 for metal casing)
- Wide temperature tolerance -40°C ~ 70°C (-40°F ~ 158°F)
- Support for TV-out
- Two-way audio
- Built-in micro SD card slot (SD / SDHC / SDXC / UHS-I, Class 10) for local storage
- DC 12V, PoE+ (IEEE 802.3at)
- Pan 360° endlessly
- Tilt from -15° to 90°
- Pan and tilt speed of up to 240°/sec and 200°/sec, respectively
- PTZ movement (Preset, Auto Pan and Patrol)
- PTZ patrol by schedule
- AI analytics (Cross Line, Intrusion, Auto Tracking, Enter Area, Leave Area, Face Detection, People Flow Counting, Crowd Density Monitoring)
- Auto focus
- 3D noise reduction
- Motion detection
- Privacy mask
- ONVIF (Profile G, S, T) conformant

Introduction

GV-SD4825-IR is an outdoor network PTZ camera that offers 25x optical zoom and unlimited digital zoom, capable of showing smooth live view with great details. This camera can simultaneously deliver three video streams in resolutions up to 2688 x 1520 at 30 fps. In low-light environments, night vision is enhanced with its high-power LEDs, which allow up to 100 m (330 ft) effective IR distance. The camera can process scenes with contrasting intensity of lights and produce clear image using the built-in WDR Pro. The camera supports H.265 video codec to achieve better compression ratio while maintaining high quality pictures at reduced network bandwidths. It also adheres to IP67 and IK10 standards.

Empowered by deep learning algorithms, AI technology distinguishes human and vehicles from other moving objects. GV-SD4825-IR supports AI perimeter protection, people flow counting, auto tracking, motion detection, audio detection and more.

Deep Learning Function

Face Detection



AI Perimeter Protection

(Intrusion, Crossing Line
Entering Area, Leaving Area)

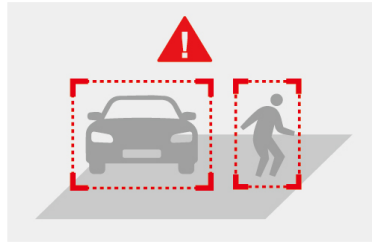

People Counting

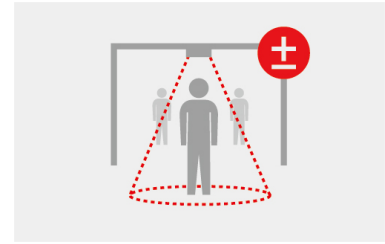

Note: The integration of AI events of the camera to GV-VMS is coming soon.

Dimensions

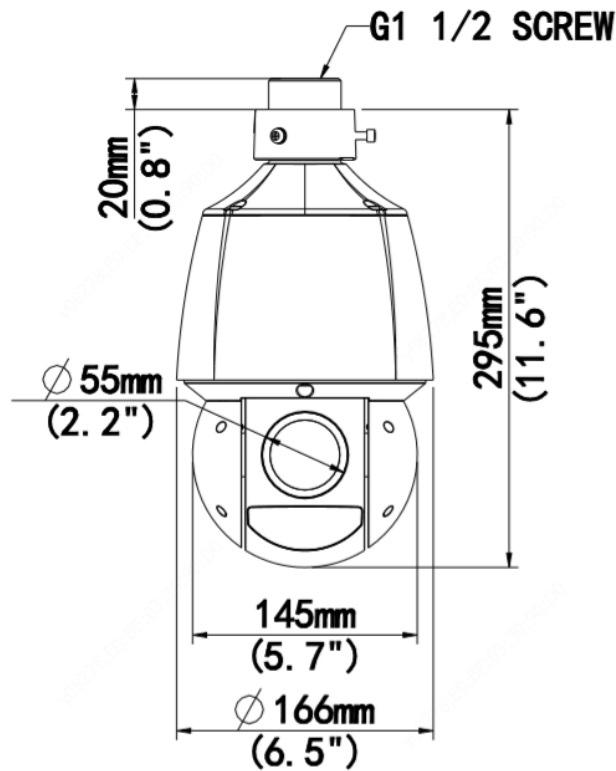

Specifications

| Camera | | |
|----------------------|-------|----------------------------------|
| Image Sensor | | 1/2.8" progressive scan CMOS |
| Optical Zoom | | 25x |
| Minimum Illumination | Color | 0.003 Lux (F1.5, AGC ON) |
| | IR ON | 0 Lux |
| Electronic Shutter | | Auto / Manual (1 ~ 1/100000 sec) |
| White Balance | | Auto / Manual |
| Iris control | | Auto / Manual |
| AGC control | | Auto / Manual |
| S/N Ratio | | 56 dB |
| WDR | | WDR Pro |
| Dynamic Range | | Up to 120 dB |

| Optical Lens | | |
|------------------------|-------------------------------------|---|
| Megapixel | | 4 MP |
| Day / Night | | Yes (with removable IR-cut filter) |
| Focal Length | | 4.8 ~ 120 mm |
| Lens Type | | Motorized varifocal lens |
| Maximum Aperture | | F1.5 |
| Horizontal FOV | | 52.20° ~ 2.74° |
| Operation | Focus | Auto / Manual |
| | Zoom | 25x |
| | Iris | Auto / Manual |
| IR LED Quantity | | 4 IR LEDs |
| Max. IR Distance | | 100 m (330 ft) |
| Video | | |
| Video Compression | | H.265, H.264, MJPEG |
| Video Streaming | | Triple streams from H.265, H.264 or MJPEG |
| Video Resolution | Main Stream | 2688 x 1520 (Default), 2560 x 1440, 1920 x 1080, 1280 x 720, 720 x 576, 640 x 360. |
| | Sub Stream | 1920 x 1080, 1280 x 720, 720 x 576, 640 x 480, 640 x 360 (Default) |
| | Third Stream (Closed by Default) | 720 x 576, 704 x 288, 640 x 360, 352 x 288 |
| Frame Rate | | 30 fps at 2688 x 1520, 30 fps at 2560 x 1440, 30 fps at 1920 x 1080 (60 / 50 Hz) * The frame rate and performance may vary depending on the number of connections and data bitrates (different scenes). |
| Video Analytics | | Motion Detection, Tampering Alarm, Audio Detection *Tampering alarm and audio detection are only accessible through the camera's Web interface, which can be used to trigger alerts such as e-mail and FTP |
| Image Setting | | Brightness, Contrast, Saturation, Sharpness, Flicker-less, Image Orientation (Flip, Mirror, 0°, 90°, 180°, 270°-including Corridor format) |
| Audio | | |
| Audio Compression | | G.711 |
| Audio Support | | Two-way Audio (external microphone and speaker required) |
| Deep Learning Function | | |
| AI Analytics | | Cross Line, Intrusion, Auto Tracking, Enter Area, Leave Area, Face Detection, People Flow Counting, Crowd Density Monitoring |
| Network | | |
| Interface | | 10/100 Ethernet |
| Protocol | | 802.1x, ARP, DHCP, DDNS, DNS, DynDNS, FTP, HTTP, HTTPS, ICMP, IGMP, IPv4, NTP, PPPoE, QoS, RTCP, RTP, RTSP, SMTP, SNMP, TCP, UDP, UPnP, ONVIF (Profile G, S, T) |
| Mechanical | | |
| Connectors | Power | DC Jack (DC 12V 2A), PoE+ (IEEE 802.3at) |
| | Ethernet | 10/100 Base-TX, RJ-45 connector |
| | Audio | 1 in (Audio In Wire); 1 out (Audio Out Wire) *The Audio In port only supports microphones with power supply. |
| | Local Storage | Micro SD card slot (SD / SDHC / SDXC / UHS-I, Class 10) *UHS-II card types are not supported. |
| | TV-Out | BNC connector: NTSC (720 x 576 at 30 fps), PAL (720 x 576 at 25 fps) |
| | Digital I/O | I/O wires |
| | RS-485 | RS-485 wires (Private-KR, Pelco D, Pelco P) |
| Operation | | |
| Pan Travel | | 360° endless |
| Tilt Travel | | -15° ~ 90° |
| Manual Speed | Pan | 0.1° ~ 200°/s |
| | Tilt | 0.1° ~ 120°/s |
| Preset Speed | Pan | 240°/s |
| | Tilt | 200°/s |
| Presets | Max. Number | 255 |
| | Accuracy | 0.2° |
| Patrol | Max. Number | 16 |
| | Max. Actions Allowed | 32 |
| OSD | | 8 |

| | | |
|-------------------------------------|--|--|
| Privacy Mask | 24 | |
| Proportional Pan & Tilt | Auto (Pan and tilt speed proportional to zoom ratio) | |
| Automatic Function | Preset, Patrol (Including Auto Pan) | |
| Mechanical Flip | Yes | |
| Digital Slow Shutter | On / Off | |
| Motion Detection | On / Off | |
| Wide Dynamic Range | On / Off | |
| Day/Night: Mechanical IR Cut Filter | On / Off | |
| Image Rotation | Normal, Flip Vertical, Flip Horizontal, 180°, 90° Clockwise, 90° Anti-clockwise | |
| 3D Noise Reduction | 0 ~ 255 | |
| Alarm | Digital I/O | 2 Inputs, dry contact, NO / NC |
| | | 1 Relay Output (AC 125V 0.5A / DC 30V 1A) |
| | Reaction | Alarm Output, PTZ to Preset, Trigger Storage |
| General | | |
| Operating Temperature | -40°C ~ 70°C (-40°F ~ 158°F) | |
| Humidity | 20% ~ 90% (non-condensing) | |
| Dimensions | Ø166 x 295 mm (6.5" x 11.6") | |
| Weight | 3.05 kg (6.72 lb) | |
| Power Source | DC 12V, PoE+ (IEEE 802.3at) | |
| Power Consumption | 21W | |
| Ingress Protection | IP67 | |
| Vandal Resistance | IK10 for metal casing | |
| Regulatory | CE, FCC, RoHS compliant | |
| Web Interface | | |
| Installation Management | Web-based configuration | |
| Maintenance | Firmware upgrade through Web Browser or Utility | |
| Access from Web Browser | Live View, Video Recording, Change Video Quality, Bandwidth Control, Image Snapshot, Text Overlay, Image Masking | |
| Language | Czech, English, French, German, Hungarian, Italian, Japanese, Polish, Portuguese, Russian, Spanish, Traditional Chinese | |
| Software Applications | | |
| Software Supported | GV-DVR / NVR (V8.9.1), GV-VMS (V17.4.3 / V18.2.1), GV-Control Center (V3.8.0 / V4.0.1), GV-Edge Recording Manager Windows Version (V2.0.0), GV-Recording Server / Video Gateway (V2.0.0), GV-Redundant / Failover Server (V1.2.0), GV-Mobile Server (V1.5.1), GV-AI Guard (V1.0.0) | |
| Smart Device Access | GV-Eye for iOS and Android | |
| Live Viewing | Bowser (IE, Edge, Chrome, Firefox, Safari), Mobile App | |









Note:

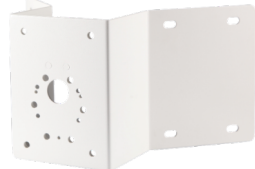

1. It is required to apply patch files to the supported software.
2. Do not use clothes or any ordinary material to clean the camera cover since they may result in scratches.
3. Mind the following when using an inserted memory card for recording:
 - Recorded data on the memory card can be damaged or lost if the data are accessed while the camera is under physical shock, power interruption, memory card detachment or when the memory card reaches the end of its lifespan. No guarantee is provided for such causes.
 - The stored data can be lost if the memory card is not accessed for a long period of time. Back up your data periodically if you seldom access the memory card.
 - Memory cards are expendable and their durability varies according to the conditions of the installed site and how they are used. Back up your data regularly and replace the memory card annually.
 - To avoid power outage, it is highly recommended to apply a battery backup (UPS).
 - For better performance, it is highly recommended that you use a micro SD card of SDHC/SDXC, Class 10.
 - Replace the memory card when its read/write speed is lower than 6 MB/s or when the memory card is frequently undetected by the camera.
4. Specifications are subject to change without notice.

Packing List

- | | |
|----------------------------|--------------------------|
| 1. GV-SD4825-IR Speed Dome | 4. M4 Hex Key |
| 2. Torx Wrench | 5. Waterproof Guidelines |
| 3. Waterproof Rubber Set | 6. Download Guide |

Accessories

| Model No. | Name | | Details |
|---------------|--------------------------------------|--|--|
| GV-Mount104 | Straight Tube Kit |  | Dimensions: 219 x 125 x 332 mm (8.6" x 4.9" x 13.1") Weight: 1.8 kg (3.97 lb) |
| GV-Mount105 | Straight Tube and Junction Box Kit |  | Dimensions: 256 x 256 x 297 mm (10.1" x 10.1" x 11.7") Weight: 6.2 kg (13.67 lb) |
| GV-Mount208-3 | Swan Neck Mount |  | Dimensions: 1043 x 519 x 256 mm (41.06" x 20.43" x 10.08") Weight: 10.6 kg (23.37 lb) |
| GV-Mount210 | Wall Pendant Mount |  | Dimensions: 200 x 140 x 249 mm (7.9" x 5.5" x 9.80") Weight: 1.1 kg (2.43 lb) |
| GV-Mount300-1 | Convex Corner Adapter Kit |  | Dimensions: 238.6 x 395.2 x 210 mm (9.4" x 15.5" x 8.2") Weight: 4.27 kg (9.41 lb) |
| GV-Mount310-1 | Concave Corner Adapter Kit |  | Dimensions: 111.2 x 369.9 x 210 mm (4.37" x 14.5" x 8.2") Weight: 2.96 kg (6.53 lb) |
| GV-Mount400-1 | Pole Mount Bracket Kit (Ø 4" ~ 6") |  | Bracket: 68.4 x 240 x 163 mm (2.69" x 9.44" x 6.41") Weight: 1.70 kg (3.75 lb) Steel Strap Diameter: Ø 4" ~ 6" |
| GV-Mount410-1 | Pole Mount Bracket Kit (Ø 6" ~ 7.5") |  | Bracket: 68.4 x 240 x 163 mm (2.69" x 9.44" x 6.41") Weight: 1.70 kg (3.75 lb) Steel Strap Diameter: Ø 6" ~ 7.5" |

| | | | |
|---------------|--|---|--|
| GV-Mount501 | Convex Corner Box Mount |  | Dimensions: 136 x 256 x 256 mm (5.4" x 10.1" x 10.1") Weight: 4.8 kg (10.6 lb) |
| GV-Mount702 | Extension Tube |  | Four options are available. Dimensions: Ø 5.4" x 10" or 20 or 30 or 50 cm (Ø 2.1" x 3.9" or 7.9" or 11.8" or 19.7") Weight: 180 g or 390 g or 550 g or 800 g (0.4 lb or 0.86 lb or 1.21 lb or 1.76 lb) |
| GV-POE Switch | GV-POE Switch is designed to provide power along with network connection for IP devices. The GV-POE Switch is available in various models with different numbers and types of ports. | | |
| Power Adapter | Contact our sales representatives for the countries and areas supported. | | |