

GV-TDR8805 AI 8MP H.265 Super Low Lux WDR Pro IR Mini Fixed Rugged IP

Dome



- AI deep learning: AI Perimeter Protection & Classification (Human, Vehicle)
- 1/2.7" progressive scan CMOS sensor
- Triple streams from H.265, H.264 or MJPEG
- Min. illumination at 0.003 lux
- Up to 20 fps at 3840 x 2160
- Wide Dynamic Range Pro (WDR Pro)
- Day and night function (with removable IR-cut filter)
- Intelligent IR
- IR distance up to 30 m (100 ft)
- Built-in micro SD card slot (SD / SDHC / SDXC / UHS-I, Class 10) for local storage
- 3-axis mechanism (pan / tilt / rotate)
- Ingress protection (IP67)
- Vandal Resistance (IK10 for metal casing)
- DC 12V / PoE (IEEE 802.3af)
- Defog
- 3D noise deduction
- AI analytics (Intrusion, Cross Line, Enter Area, Leave Area, Face Detection, People Flow Counting, Crowd Density Monitoring)
- Motion detection
- Tampering alarm
- Text overlay
- Privacy mask
- 12 languages supported
- Built-in microphone
- Two-way audio
- ONVIF (Profile G, S, T) conformant

Introduction

GV-TDR8805 is an outdoor, fixed, network camera equipped with an automatic IR-cut filter and an IR LED for day and night surveillance. The camera supports H.265 video codec to achieve better compression ratio while maintaining high quality pictures at reduced network bandwidths. The camera adheres to IP67 and IK10 standards, and can be powered through PoE.

Empowered by deep learning algorithms, AI technology distinguishes human and vehicles from other moving objects. Integrated with GeoVision Video Management Software (VMS), it supports AI perimeter protection, real time alert, playback and more.

Deep Learning Function

Face Detection

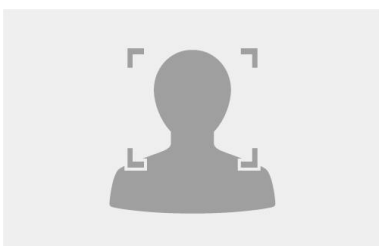

AI Perimeter Protection

(Intrusion, Crossing Line, Entering Area, Leaving Area)



People Counting



Note: The integration of AI events of the camera to GV-VMS is coming soon.

Dimensions

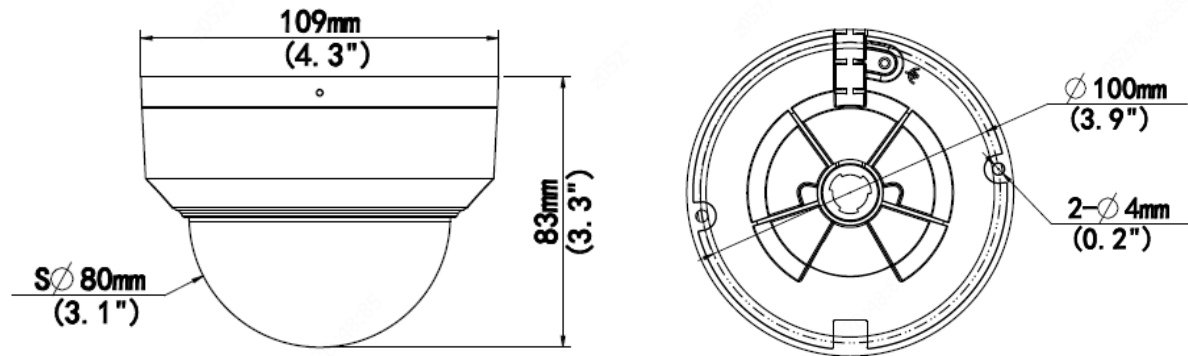

Specifications

Camera		
Image Sensor	1/2.7" progressive scan CMOS	
Picture Elements	3840 (H) x 2160 (V)	
Minimum Illumination	Color	0.003 Lux (F1.6, AGC ON)
	IR ON	0 Lux
Shutter Speed	Auto / Manual (1 ~ 1/100000 sec)	
White Balance	Automatic, Manual	
Gain Control	Automatic, Manual	
S/N Ratio	56 dB	
WDR Pro	Yes	
Dynamic Range	120 dB	
Lens		
Megapixel	8 MP	
Day / Night	Yes (with removable IR-cut filter)	
Lens Type	Fixed	
Focal Length	2.8 mm	
Maximum Aperture	F/1.6	
Mount	M12	
Horizontal FOV	112.9°	
Operation	Focus	Fixed
	Zoom	Fixed
	Iris	Fixed
IR LED Quantity	1 IR LED	
Max. IR Distance	30 m (100 ft)	
Operation		
Video Compression	H.265, H.264, MJPEG	
Video Streaming	Triple streams from H.265, H.264 or MJPEG	
Frame Rate	20 fps at 3840 x 2160, 30 fps at 3072 x 1728, 30 fps at 2560 x 1440, 30 fps at 1920 x 1080 (60 / 50 Hz) * The frame rate and performance may vary depending on the number of connections and data bitrates (different scenes).	
Video Analytics	Motion Detection, Tampering Alarm, Audio Detection *Tampering alarm and audio detection are only accessible through the camera's Web interface, which can be used to trigger alerts such as e-mail and FTP	
Image Setting	Brightness, Contrast, Saturation, Sharpness, Flicker-less, Image Orientation (Flip, Mirror, 0°, 90°, 180°, 270°-including Corridor format)	
Audio Compression	G.711	
Audio Support	Two-way Audio (External speaker required)	
Digital I/O	Input	1 Input, dry contact, NO / NC
	Output	1 Relay Output

Face Detection		
Environment		100 lux
Detectable face angle	Tilt (Up/Down)	≤ 10°
	Swing (Left/Right)	≤ 30°
Max. number of faces		Up to 40
Min. face image pixel requirement		80 pixels
Deep Learning Function		
AI Analytics		Intrusion, Cross Line, Enter Area, Face Detection, Leave Area (Human & Vehicle classification), People Flow Counting, Crowd Density Monitoring
Network		
Interface		10/100 Ethernet
Protocol		802.1x, ARP, DHCP, DDNS, DNS, DynDNS, FTP, HTTP, HTTPS, ICMP, IGMP, IPv4, NTP, PPPoE, QoS, RTP, RTSP, SMTP, SNMP, TCP, UDP, UPnP, ONVIF (Profile G, S, T)
Video Resolution		
Main Stream		3840 x 2160 (Default), 3072 x 1728, 2560 x 1440, 1920 x 1080, 1280 x 720
Sub Stream		1920 x 1080, 1280 x 720, 720 x 576, 704 x 288, 640 x 480, 640 x 360 (Default), 352 x 288
Third Stream (Closed by Default)		640 x 360, 352 x 288
Mechanical		
Temperature Detector		No
Camera Angle Adjustment	Pan	3° ~ 360°
	Tilt	0° ~ 68°
	Rotate	3° ~ 360°
Connectors	Power	DC Jack (DC 12V, 1.25A), PoE
	Ethernet	RJ-45 connector
	Audio	1 In (built-in or external microphone with power supply) 1 Out (Audio Out Wire) *The Audio In port only support microphones with power supply.
	Digital I/O	I/O wires
	Local Storage	Micro SD card slot (SD / SDHC / SDXC / UHS-I, Class 10) *UHS-II card type is not supported.
General		
Operating Temperature		-30°C ~ 60°C (-22°F ~ 140°F)
Humidity		0% ~ 95% (no condensation)
Power Source		12V DC / PoE (IEEE802.3af)
Max. Power Consumption		6W
Dimensions		∅ 109 x 83 mm (∅ 4.3" x 3.3")
Weight		0.43 kg (0.95 lb)
Ingress Protection		IP67
Vandal Resistant		IK10 for metal casing
Regulatory		FCC, CE, RoHS compliant
Web Interface		
Installation Management		Web-based configuration
Maintenance		Firmware upgrade through Web Browser or GV-IP Device Utility
Access from Web Browser		Live View, Video Recording, Change Video Quality, Bandwidth Control, Image Snapshot, Defog, Text Overlay, Image Masking
Language		Czech, English, French, German, Hungarian, Italian, Japanese, Polish, Portuguese, Russian, Spanish, Traditional Chinese
Software Applications		
Software Supported		GV-DVR / NVR (V8.9.1), GV-VMS (V17.4.4 / V18.2.1), GV-Control Center (V3.8.0 / V4.0.1), GV-Edge Recording Manager Windows Version (V2.1.0), GV-Recording Server / Video Gateway (V2.0.1), GV-Redundant / Failover Server (V1.2.0), GV-Mobile Server (V1.5.1), GV-AI Guard (V1.0.0)
Live Viewing		Browser (IE, Edge, Chrome, Firefox, Safari), Mobile APP









Note:

1. Patch files are required for some supported software.
2. Do not use clothes or any ordinary material to clean the camera cover since they may result in scratches.
3. Specifications are subject to change without notice.

Packing List

- | | |
|--------------------------|--------------------------|
| 1. GV-TDR8805 Mini Dome | 4. Drill Template Paster |
| 2. Waterproof Rubber Set | 5. Torx Wrench |
| 3. Screw Kit | 6. Download Guide |

Accessories

Model No.	Name		Details
GV-Mount107 (must be used with GV-Mount213)	Pendant Bracket		Dimensions: Ø 120 x 334 mm (Ø 4.72" x 13.15") Weight: 0.74 kg (1.63 lb)
GV-Mount211P	Wall Mount and Junction Box		Dimensions: Ø 233 x 125 x 125 mm (Ø 9.2" x 4.9" x 4.9") Weight: 1 kg (2.2 lb)
GV-Mount213	Wall / Ceiling Box Mount		Dimensions: Ø 109 x 39 mm (Ø 4.3" x 1.5") Weight: 0.2 kg (0.44 lb)
GV-Mount300-2	Convex Corner Mount		Dimensions: 137 x 233 x 160 mm (5.4" x 9.17" x 6.3") Weight: 1.65 kg (3.64 lb)
GV-Mount310-2	Concave Corner Mount		Dimensions: 111.2 x 369.9 x 210 mm (2.6" x 11.4" x 6.6") Weight: 1.65 kg (3.64 lb)
GV-Mount420 (must be used with GV-Mount211P)	Pole Mount Bracket		Dimensions: Ø 120 x 120 x 53.4 mm (Ø 4.7" x 4.7" x 2.1") Weight: 0.45 kg (0.99 lb) Steel Strap Diameter: Ø 67 ~ 127 mm (Ø 2.6" ~ 5")
GV-Mount704 (must be used with GV-Mount107)	Extension Tube		Dimensions: Ø 3.5 x 10 or 20 or 30 or 50 cm (Ø 1.38 x 3.9 or 7.9 or 11.8 or 19.7") Weight: 225g or 360g or 500g or 780g (0.5 lb or 0.79 lb or 1.1 lb or 1.72 lb)
GV-PA191	Power over Ethernet (PoE) Adapter		The GV-PA191 is a Power over Ethernet (PoE) adapter designed to provide power to the IP device through a single Ethernet cable.
GV-POE Switch			The GV-POE Switch is designed to provide power along with network connection for IP devices. The GV-POE Switch is available in various models with different numbers and types of ports.
Power Adapter			Contact our sales representatives for the countries and areas supported.