

MEGApix[®] 5MP vandal ball IP camera

DWC-MVA5WiAT



User's Manual Ver. 06/20

Before installing and using the camera, please read this manual carefully.
Be sure to keep it handy for future reference.

Safety Information

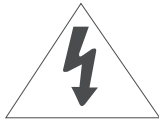

CAUTION

RISK OF ELECTRIC SHOCK.
DO NOT OPEN.



CAUTION:

TO REDUCE THE RISK OF ELECTRIC SHOCK, DO NOT REMOVE COVER (OR BACK) NO USER SERVICEABLE PARTS INSIDE. REFER SERVICING TO QUALIFIED SERVICE PERSONNEL.



Warning

This symbol indicates that dangerous voltage consisting of a risk of electric shock is present within this unit.



Precaution

This exclamation point symbol is intended to alert the user to the presence of important operating and maintenance (servicing) instructions in the literature accompanying the appliance.

WARNING

To prevent damage which may result in fire or electric shock hazards, do not expose this appliance to rain or moisture.

WARNING

1. Be sure to use only the standard adapter that is specified in the specification sheet. Using any other adapter could cause fire, electrical shock, or damage to the product
2. Incorrectly connecting the power supply or replacing the battery may cause an explosion, fire, electric shock, or damage to the product.
3. Do not connect multiple cameras to a single adapter. Exceeding the capacity may cause excessive heat generation or fire.
4. Securely plug the power cord into the power receptacle. An insecure connection may cause a fire.
5. When installing the camera, fasten it securely and firmly. A falling camera may cause personal injury.
6. Do not place conductive objects (e.g. screwdrivers, coins, metal items, etc.) or containers filled with water on top of the camera. Doing so may cause personal injury due to fire, electric shock or falling objects.
7. Do not install the unit in humid, dusty, or sooty locations. Doing so may cause fire or electric shock.
8. If any unusual smells or smoke come from the unit, stop using the product. Immediately disconnect the power source and contact the service center. Continued use in such a condition may cause fire or electric shock.
9. If this product fails to operate normally, contact the nearest service center. Never disassemble or modify this product in any way.
10. When cleaning, do not spray water directly onto parts of the product. Doing so may cause fire or electric shock.

Precaution

Operating

- Before using, make sure the power supply and all other parts are properly connected.
- While operating, if any abnormal condition or malfunction is observed, stop using the camera immediately and contact your dealer.

Handling

- Do not disassemble or tamper with parts inside the camera.
- Do not drop the camera or subject it to shock or vibration as this can damage the camera.
- Clean the clear dome cover with extra care. Scratches and dust can ruin the quality of the camera image.

Installation and Storage

- Do not install the camera in areas of extreme temperature, exceeding the allowed range.
- Avoid installing in humid or dusty environments.
- Avoid installing in places where radiation is present.
- Avoid installing in places where there are strong magnetic fields and electric signals.
- Avoid installing in places where the camera would be subject to strong vibrations.
- Never expose the camera to rain or water.

Important Safety Instructions

1. **Read these instructions.** - All safety and operating instructions should be read before installation or operation.
2. **Keep these instructions.** - The safety, operating and use instructions should be retained for future reference.
3. **Heed all warnings.** - All warnings on the product and in the operating instructions should be adhered to.
4. **Follow all instructions.** - All operating and use instructions should be followed.
5. **Do not use this device near water.** - For example: near a bathtub, washbowl, kitchen sink, laundry tub, in a wet basement; near a swimming pool; etc.
6. **Clean only with a dry cloth.** - Unplug this product from the wall outlet before cleaning. Do not use liquid cleaners.
7. **Do not block any ventilation openings. Install following the manufacturer's instructions.** - Slots and openings in the cabinet are provided for ventilation, to ensure reliable operation of the product, and to protect it from overheating. The openings should never be blocked by placing the product on a bed, sofa, rug or other similar surfaces. This product should not be placed in a built-in installation such as a bookcase or rack unless proper ventilation is provided and the manufacturer's instructions have been adhered to.
8. **Do not install near any heat sources such as radiators, heat registers, or other apparatus (including amplifiers) that produce heat.**
9. **Do not defeat the safety purpose of the polarized or grounding-type plug.** A polarized plug has two blades with one wider than the other. A grounding type plug has two blades and a third grounding prong. The wide blade or the third prong are provided for your safety. If the provided plug does not fit into your outlet, consult an electrician for replacement.
10. **Protect the power cord from being walked on or pinched particularly at plugs, convenience receptacles, and the point where they exit from the apparatus.**
11. **Only use attachments/accessories specified by the manufacturer.**
12. **Use only with cart, stand, tripod, bracket, or table specified by the manufacturer, or sold with the apparatus. When a cart is used, use caution when moving the cart/apparatus combination to avoid injury from tip-over.**
13. **Unplug the apparatus during lightning storms or when unused for long periods.**
14. **Refer all servicing to qualified service personnel. Servicing is required when the apparatus has been damaged in any way, such as power supply cord or plug is damaged, liquid has been spilled or objects have fallen into the apparatus, the apparatus has been exposed to rain or moisture, does not operate normally, or has been dropped.**



Disposal of Old Appliances



1. When this crossed-out wheel bin symbol is attached to a product it means the product is covered by the European Directive 2002/96/EC.
2. All electrical and electronic products should be disposed of separately from the municipal waste stream under laws designated by the government or the local authorities.
3. The correct disposal of your old appliance will help prevent potential negative consequences for the environment and human health.
4. For more detailed information about disposal of your old appliance, please contact your city office, waste disposal service or the shop where you purchased the product.



This equipment has been tested and found to comply with the limits for a Class A digital device, pursuant to part 15 of the FCC Rules. These limits are designed to provide reasonable protection against harmful interference when the equipment is operated in a commercial environment. This equipment generates, uses, and can radiate radio frequency energy and, if not installed and used in accordance with the instruction manual, may cause harmful interference to radio communications. Operation of this equipment in a residential area is likely to cause harmful interference in which case the user will be required to correct the interference at his own expense.

Table of Contents

Introduction

Product and accessories.....	5
Parts identification.....	6

Installation

Disassemble the camera.....	7
Factory reset.....	7
Installation.....	8
Cabling.....	10

Network Setup

DW IP finder.....	11
-------------------	----

Web Viewer

Login to the camera.....	12
GUI overview.....	13

Camera Settings

Settings > Video and audio setup.....	14
Settings > Camera setup > Image adjustment.....	21
Settings > Camera setup > Exposure settings.....	22
Settings > Camera setup > Day and night settings.....	23
Settings > Camera setup > Backlight settings.....	24
Settings > Camera setup > White Balance settings.....	25
Settings > Camera setup > Image enhancement settings.....	26
Settings > Camera setup > Video enhancement.....	27
Settings > Network setup.....	28
Settings > Trigger action setup.....	38
Settings > Event setup.....	41
Settings > Security setup.....	45
Settings > System setup > System information.....	52
Settings > System setup > Firmware.....	54
Settings > System setup > Date and time.....	55
Settings > System setup > DST.....	56
Settings > System setup > Users.....	57
Settings > System setup > System log.....	58
Settings > System setup > Factory reset.....	59
Settings > System setup > Restart.....	60
Settings > System setup > System open source license.....	61

Network setup guides.....	62
----------------------------------	-----------

FAQs.....	69
------------------	-----------

Dimensions.....	70
------------------------	-----------

Specifications.....	71
----------------------------	-----------

Warranty.....	72
----------------------	-----------

Limits and exclusions.....	73
-----------------------------------	-----------

Introduction - Product and accessories

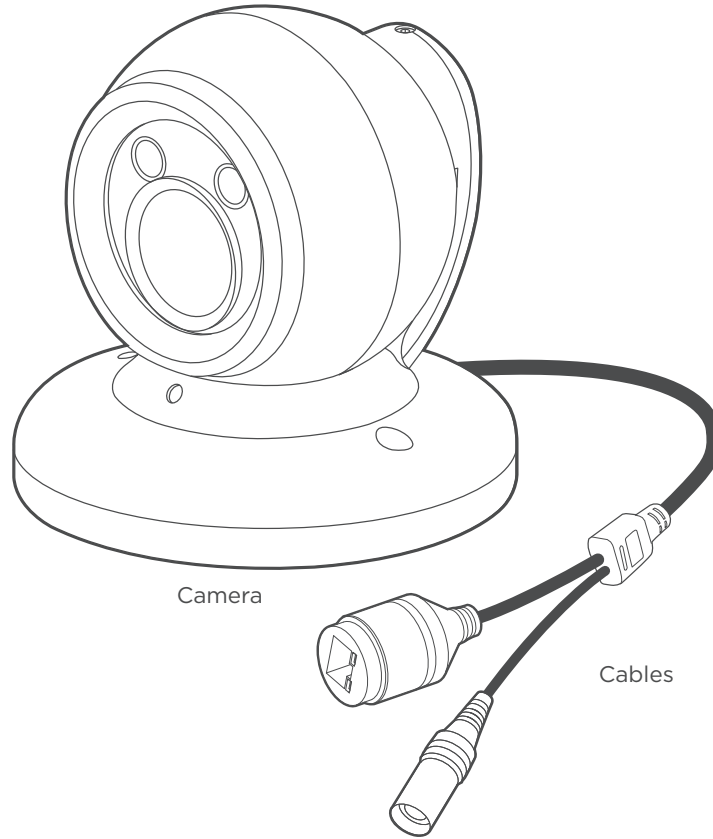

Camera

Cables

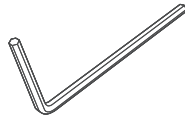

Hex Allen Wrench

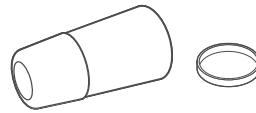

Waterproof Cap and Gasket

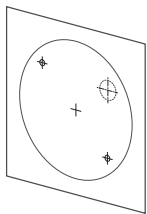

Mounting Template

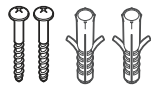

Screws and Plastic Anchors - 2pcs

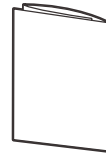

Quick Setup and Download Guides

Introduction - Part names

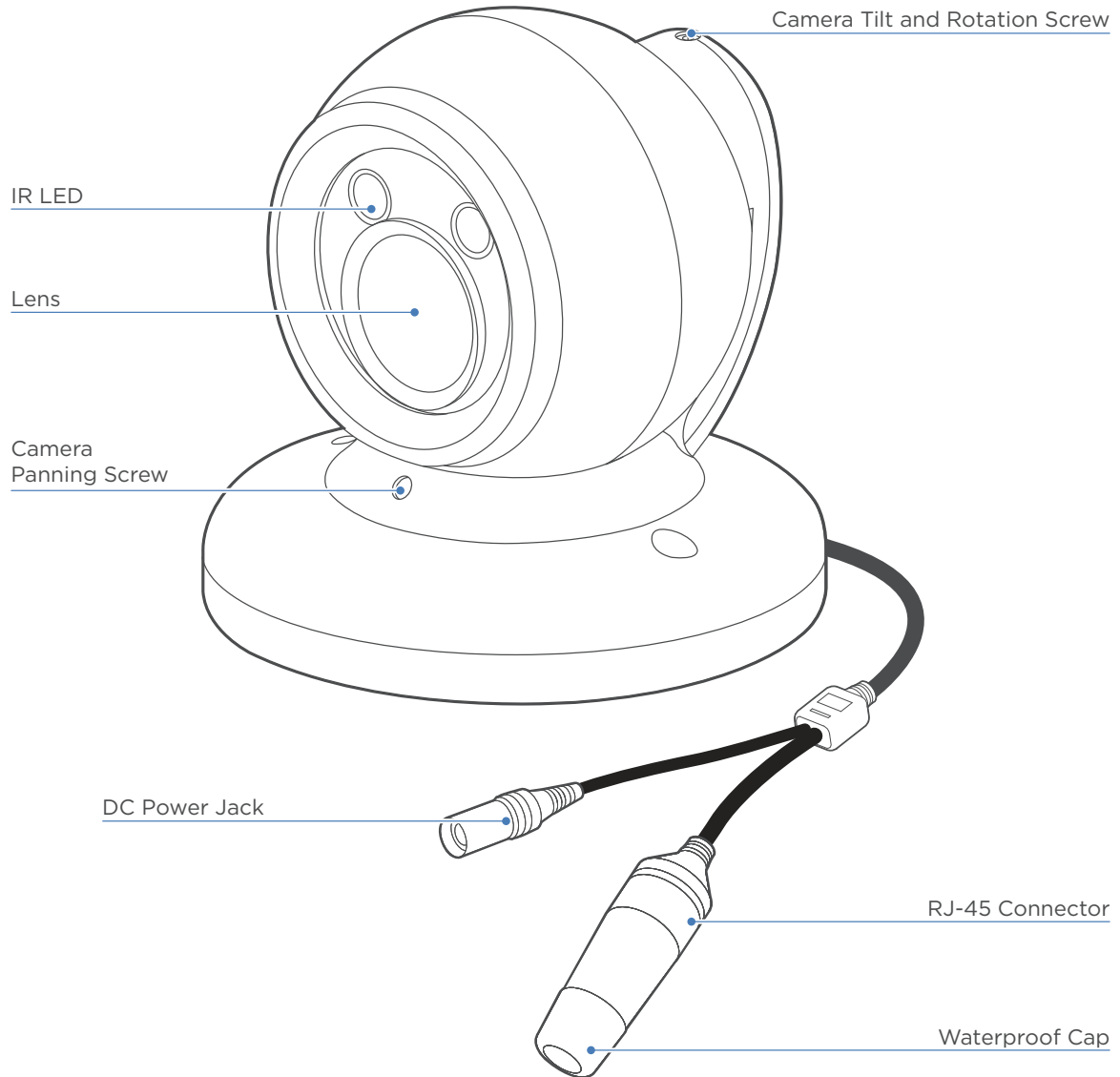

Installation - Disassemble the camera

Before installing your camera, read the following cautions.

1. Make sure the mounting surface can hold up to five times the weight of your camera.
2. Do not let cables get caught in improper places or the electric line cover gets damaged. It may cause a breakdown or fire.
3. When installing your camera, do not allow any unauthorized personnel to approach the installation site. If you have any valuable things under the place, move them away.

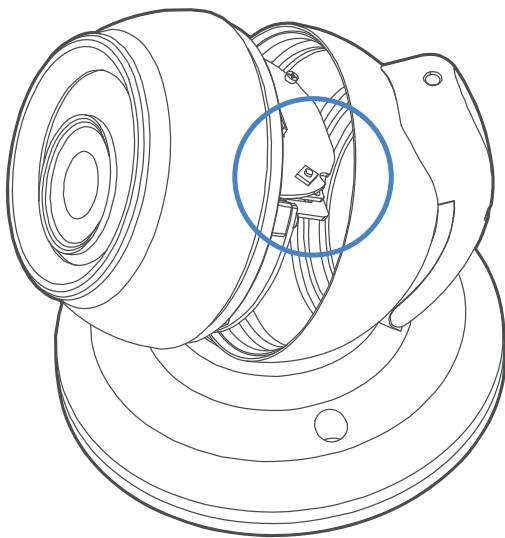

① To reset the camera, detach the ball module from the base by rotating it counter-clockwise.

⚠ **Do not touch any other parts of the camera.**

② Press the reset button on the base of the camera's lens module. Pressing the button for five (5) seconds will initiate a camera-wide reset of all the settings, including network settings.

⚠ When replacing the camera's ball module back into place, make sure no cables are caught or got disconnected. Rotate the ball module clockwise until it is secured in place.

⚠ **Warning:**

If you press the 'Reset' button, you will lose all setting data. If needed, please, make a note for further installation.

Installation - Installation

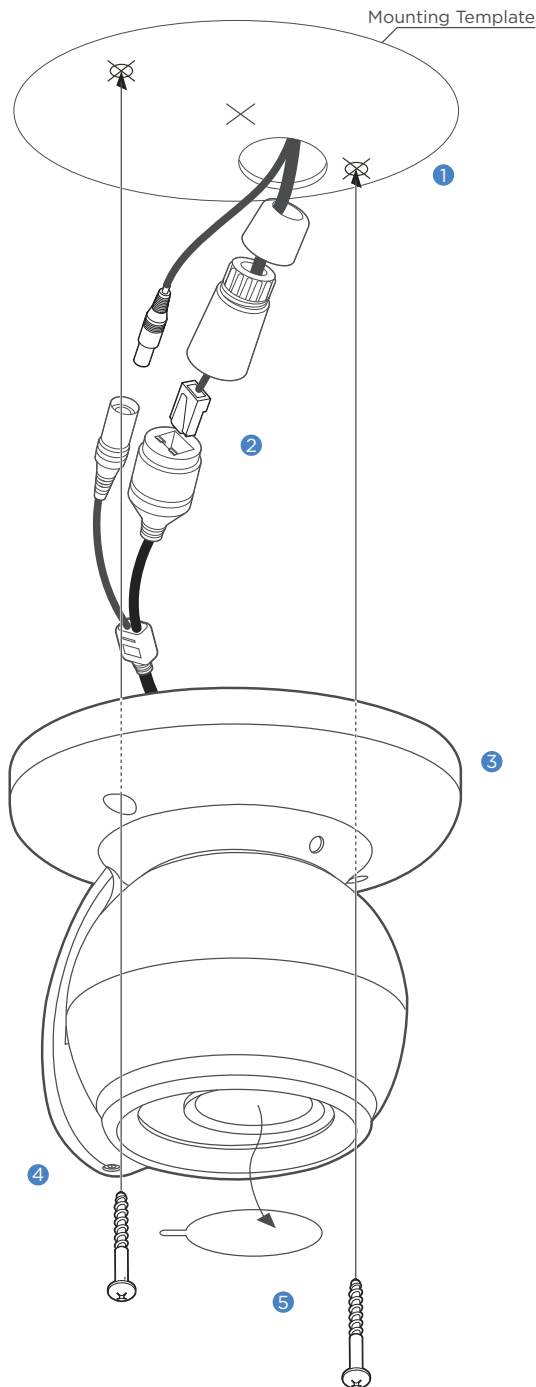

- 1 Using the mounting template sheet or the camera itself, mark and drill the necessary holes in the wall or ceiling.
- 2 Connect the network cable and power cable respectively. See 'Installation - Cabling' for details.
 - ⚠ To use the camera's waterproof wiring:
 - a. Install the LAN cable into (a) .
 - b. (b) will be assembled to (a) with a 1/4 turn.
 - c. Thread (c) tightly to (b).

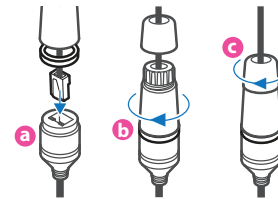

NOTE: To ensure moisture seal, make sure the o-ring is in place between (a) and (b). In extreme environments use of an outdoor rated sealer is recommended.

NOTE: When using the waterproof cap, crimp the RJ45 connector after passing the cable through the waterproof cap.

- 3 Use the two mounting screws to mount the camera on the mounting surface.
 - ⚠ Loosen the pan/tilt/rotate screws a little before fixing the camera.
- 4 Adjusting the camera's angle and view and tighten the pan/tilt/rotate screws to lock the camera's position.
- 5 Remove the protective film from the camera's lens to complete the installation.

Installation - Adjusting the camera's angle

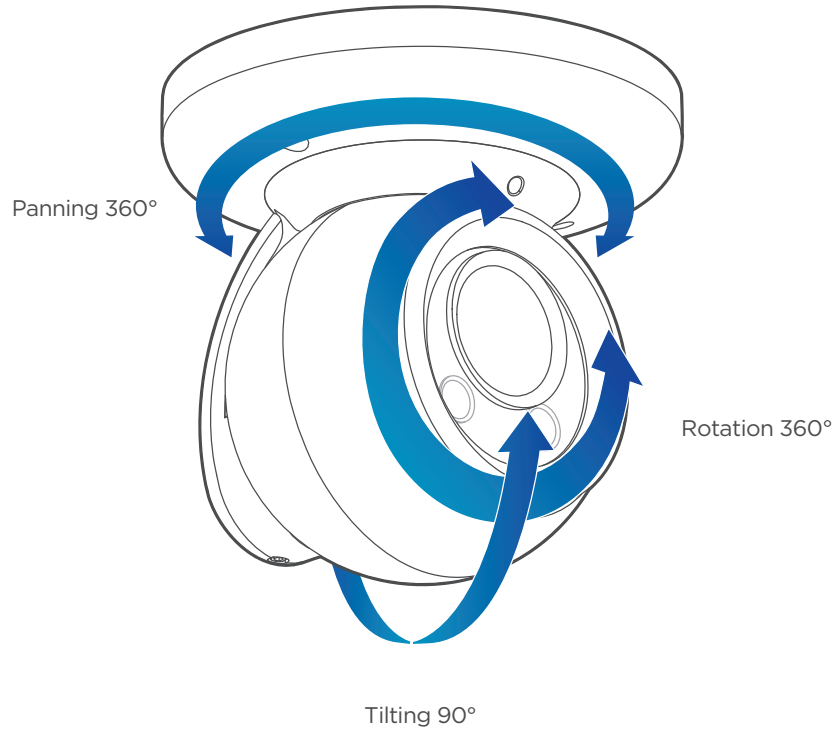

Installation - Cabling

Two cabling options

Use a PoE-enabled switch to connect data and power through a single cable and begin viewing and recording images instantly.

A non-PoE switch will require an adaptor for power transmission.

1. Using a PoE-Enabled Switch

The camera is PoE-compliant, allowing transmission of power and data via a single Ethernet cable. PoE eliminates the need for the different cables used to power, record, or control the camera. Follow the illustration below to connect the camera to a PoE-enabled switch using an Ethernet cable.

2. Using a Non-PoE Switch

If a PoE-enabled switch is not used, use a power adaptor for power transmission and non-PoE switch for data transmission.

Follow the illustrations below to connect the camera without a PoE-enabled Switch.

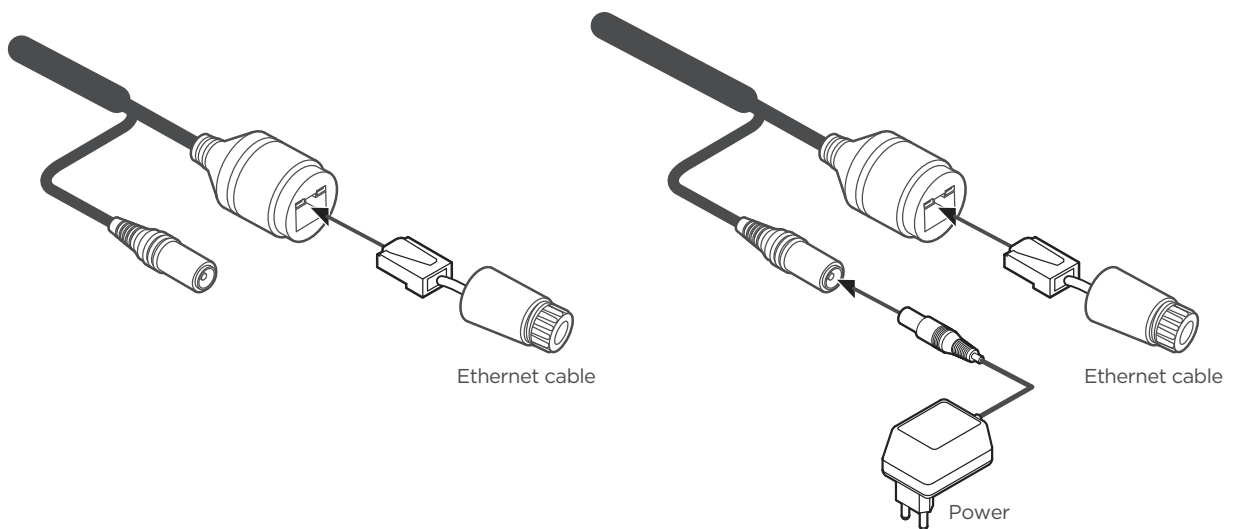

Network setup - DW IP Finder™

Thumbnail view

Select network to scan

Filter device type to scan

Scan devices

Show/hide thumbnail view

Refresh thumbnail view

Bulk IP assignment

Firmware upgrade

Firmware version

Camera's uptime

Open device configuration settings

Device's information

- 1 Go to: <http://www.digital-watchdog.com> and search for 'IP Finder' on the quick-search bar at the top of the page.
- 2 The latest IP Finder software will appear in the search results. Click on the link to download the file to your computer.
- 3 The software will scan your network for all supported cameras and display the results in the table. Allow up to 5 seconds for the IP Installer to find the camera on the network.
- 4 You can press the 'Refresh List' to search the network again, or filter the search results by entering a value in the filter box.
- 5 Check the box next to 'Display Camera Thumbnail' to view a JPEG image of the camera's view next to the camera name on supported models.

- i The default network type of camera is DHCP mode.
- i If you have a DHCP server, it will automatically set the Camera IP.
- i Contact your network administrator for more information.

- 6 To save the changes made to the camera's settings, input ID and PW of the camera for authentication.
- 7 If the camera needs to be rebooted after the settings were changed, press the 'Reboot' button. The camera will power cycle and will appear back in the search results once the reboot is complete.

- i Default ID / PW : admin / admin
- i For security purposes, it is highly recommended to change your password after initial setup.

- 8 Click 'Save' to save changed values.
- 9 To update the camera's firmware from the DW IP Finder™, click on the firmware tab, upload the firmware file and select the camera to update. You can update multiple cameras at the same time.

Web Viewer Screen - Basic Screen (Default)

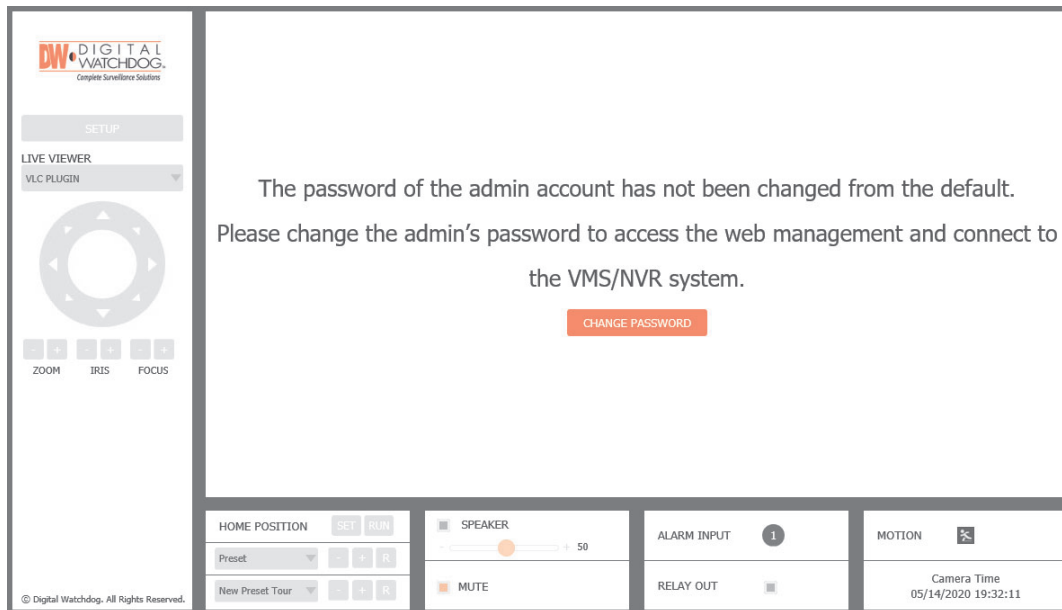

Password change is required at the initial connection in a factory reset state.

- 1 You cannot see the image, and the setup button is disabled.
- 2 Change the password with the CHANGE PASSWORD button.

- 3 After changing the password, login again by pressing the RE-LOGIN button.
 - Internet Explorer: After three failed attempts or the cancel button is clicked, you will experience a login fail.
 - Other Browsers: After the Cancel button is clicked, you will experience a login fail.

✘ Password Hint Page

- If you need help remembering the password for your user, input the username in the username field and press the hint button. If you added a hint for your password when setting it up, it will appear then.

Web Viewer Screen - Basic Screen



- ⌘ The web viewer is optimized with Internet Explorer 10 (or above) and Mozilla Firefox.
- ⌘ “If VLC is not installed or the VLC plugin is not supported (Chrome), ‘Live Buffering’ and ‘Channel Select’ (subjects 3 and 4 in the diagram) will display as ‘Live Viewer’. If so, select HTML5 (MJPEG) from the Live Viewer menu to view the video.

- 1 Live video display. This is the region for the live video stream from the camera.
- 2 Setup a popup button. Click it to open the Setup page to setup details of IP camera like Video, Network, Events, System, etc. See the section ‘Setup’.
- 3 When the image is not smooth due to a sbad network connection, it stored image during setup time and shows the image on the live view screen.
 - ⌘ Users will see the delayed images based on the set delay time.
- 4 Channel Select button. Select a stream produced from the camera between Stream 1 - 3 to display it in the live view screen.
 - ⌘ Refer the ‘Setup > Video & Audio > Video’ to setup the Video Stream.
- 5 Below “Menu” is supported per models.

 - PTZ control** - Not supported.
 - Preset** - Not supported.
 - Speaker control** - Not supported.
 - Alarm input** - Not supported.
 - Relay out** - Not supported.
- 6 **Motion** - Shows the motion event status.
 - ⌘ Event Alert Icon (🚨) appears if ‘Motion Detection’ is activated.
- 7 **Camera Time** - Display the camera time.

Setup - Video & Audio Setup

Video Configuration

1 Detail Page - When you select an item from the menu, you can set the details for the selected item.

2 Setup Menu

Video and Audio
[VIDEO, OSD, ROI, PRIVACY MASK]

Camera
[IMAGE ADJUSTMENT, EXPOSURE, DAY&NIGHT, BACKLIGHT, WHITE BALANCE, IMAGE, VIDEO]

Network
[STATUS, NETWORK SETTING, AUTO IP, ONVIF, UPNP, DDNS, FTP, SMTP, SNMP, RTSP INFORMATION]

Trigger Action
[ACTION RULES, IMAGE TRANSFER]

Events
[EVENT RULES, MOTION, TEMPERATURE]

Security
[IP ADDRESS FILTER, RTSP AUTHENTICATION, IEEE 802.1x, HTTPS, CERTIFICATES, SERVICE]

System
[INFORMATION, DIAGNOSTICS, FIRMWARE UPDATE, DATE AND TIME, DST, USER MANAGEMENT, LOG, FACTORY RESET, RESTART, OPEN SOURCE]

1 Detail Page - When you select an item from the menu, you can set the details for the selected item.

2 Setup Menu

Video and Audio

[VIDEO, OSD, ROI, PRIVACY MASK]

Camera

[IMAGE ADJUSTMENT, EXPOSURE, DAY&NIGHT, BACKLIGHT, WHITE BALANCE, IMAGE, VIDEO]

Network

[STATUS, NETWORK SETTING, AUTO IP, ONVIF, UPNP, DDNS, FTP, SMTP, SNMP, RTSP INFORMATION]

Trigger Action

[ACTION RULES, IMAGE TRANSFER]

Events

[EVENT RULES, MOTION, TEMPERATURE]

Security

[IP ADDRESS FILTER, RTSP AUTHENTICATION, IEEE 802.1x, HTTPS, CERTIFICATES, SERVICE]

System

[INFORMATION, DIAGNOSTICS, FIRMWARE UPDATE, DATE AND TIME, DST, USER MANAGEMENT, LOG, FACTORY RESET, RESTART, OPEN SOURCE]

Setup - Video & Audio Setup

Video Configuration

VIDEO CONFIGURATION

Stream	Codec	Description
1	H.264	channel1
2	H.264	channel2
3	M-JPEG	channel3

Codec

Codec: H.264
 Description: channel1
 Resolution: 2592x1944
 Frame Rate(FPS): 30
 GOP: 30 [1 ~ 120]
 Profile: High
 Bitrate Mode: CBR
 Target Bitrate: 5120 [100Kbps ~ 10Mbps]
 Quality: 5 [1 ~ 10]
 Smart Bitrate Control: Off
 Extension Option: Off

APPLY

1 Live Video Channel Setup - The video can be configured to various settings with a combination of codec and resolution. The camera performance should be considered when setting multiple channels, as the performance of the camera will be affected.

※ H.265 (HEVC) codec with higher bitrate may cause unstable live streaming or reload the webpage.

2 Codec - Choose the video codec. Depending on the selected codec, the subcategories may be changed accordingly.

3 Description - Input the additional description of the selected channel. Max. 30 alpha-numeric characters may be used, including spaces.

4 Resolution - Select video resolution.

※ Available Frame Rate may differ even if the same codecs are in use.

<Resolution of Video Format>

5MP (QXGA)	4MP	2.1MP/1080p	720p/i	SVGA	768x432 (0.3M)	4CIF	D1	VGA	640x360 (0.2M)	CIF	SIF / 240P
2592x1944	2560x1440	1920x1080	1280x720	800x600	768x432	704x576	704x480	640x480	640x360	352x288	352x240

5 Frame Rate - Select the maximum Frame Rate.

※ Available Frame Rate can be different although the same codecs were set up.

Setup - Video & Audio Setup

Video Configuration

Stream	Codec	Description
1	H.264	channel1
2	H.264	channel2
3	M-JPEG	channel3

Codec	
Codec	H.264
Description	channel1
Resolution	2592x1944
Frame Rate(FPS)	30
GOP	30 [1 ~ 120]
Profile	High
Bitrate Mode	CBR
Target Bitrate	5120 [100Kbps ~ 10Mbps]
Quality	5 [1 ~ 10]
Smart Bitrate Control	Off
Extension Option	Off

APPLY

- 6 **GOP(Group of Pictures) Size** - Set up the number of frames (P-frame) which contain only changed information based on the basic frame (I-frame). Regarding videos with lots of movement, if you set GOP size bigger, only the number of P-frames is bigger.

As a result, the video resolution will be low but 'File size' and 'Bit-rate' can be decreased.

⚙️ **GOP(Group of Pictures) Size -**

I-frame and P-frame creation for MPEG4, H.264, and H.265 (HEVC) video compression. 'I-frame', also known as 'key-frame', refers to the complete image data for a specific video frame. 'P-frame' refers to the changes in the image in comparison to the previous video frame. As a result, the GOP consists of one I-frame and several P-frames. For improved video quality, use a lower number of P-frames for this setting.

- 7 **Profile** - The profile defines the subset of bitstream features in H.264, H.265 (HEVC) stream, including color reproduction and additional video compression.

⚙️ H.264: Main, High / H.265 (HEVC): Main

Main - An intermediate profile with a medium compression ratio. The main profile supports I-frames, P-frames, and B-frames.

High - A complex profile with a high compression ratio. The high profile supports I-frames, P-frames, and B-frames.

- 8 **Bitrate Mode** - Select the bit rate control scheme of video compression from CBR (Constant Bit Rate) or VBR (Variable Bit Rate).

CBR - To guarantee the designated constant bit rate, the quality of the video is controlled in this mode.

Therefore, the quality of the video is likely to be varying when network traffic is changing.

VBR - To guarantee the designated quality, the bit rate of the video stream is changed in this mode.

Therefore, the frame rate of the video is likely to be varying when network traffic is changing.

⚙️ This category will not appear if you select the codec.

Setup - Video & Audio Setup

Video Configuration

VIDEO CONFIGURATION

Stream	Codec	Description
1	H.264	channel1
2	H.264	channel2
3	M-JPEG	channel3

Codec

Codec: H.264
Description: channel1
Resolution: 2592x1944
Frame Rate(FPS): 30
GOP: 30 [1 ~ 120]
Profile: High
Bitrate Mode: CBR
Target Bitrate: 5120 [100Kbps ~ 10Mbps]
Quality: 5 [1 ~ 10]
Smart Bitrate Control: Off
Extension Option: Off

APPLY

Callouts: 9 points to Target Bitrate, 10 points to Quality, 11 points to Smart Bitrate Control, 12 points to Extension Option, 13 points to the APPLY button.

9 **Target Bitrate** - If Bitrate Control is set to be CBR, you can set the Target Bitrate.

10 **Quality** - For VBR control mode, The Target Quality of video can be setup.

11 **Smart Core** - Off / Smart.RC

12 **Extension Option**

Off - You cannot use the Extension Option.

SVC-T On - The H.264, H.265 (HEVC) SVC (Scalable Video Coding) is a video compression algorithm that enables effective and efficient transmission of video files over low bandwidth networks.

13 Click 'Apply' to save all settings.

Setup - Video & Audio Setup

OSD Configuration

ON SCREEN DISPLAY(OSD) CONFIGURATION

1 **Date & Time**
 Off On
Position X: 0 [0 ~ 100]
Position Y: 0 [0 ~ 100]

2 **User Text**
 Off On
Position X: 0 [0 ~ 100]
Position Y: 0 [0 ~ 100]
Text:

3 **APPLY**

- 1 Date / Time** - Display the current time.
- 2 User Text** - Output the TEXT entered by the user. Support a maximum of 30 characters.
- 3** Click 'Apply' to save all settings.

Setup - Video & Audio Setup

Region of Interest Configuration

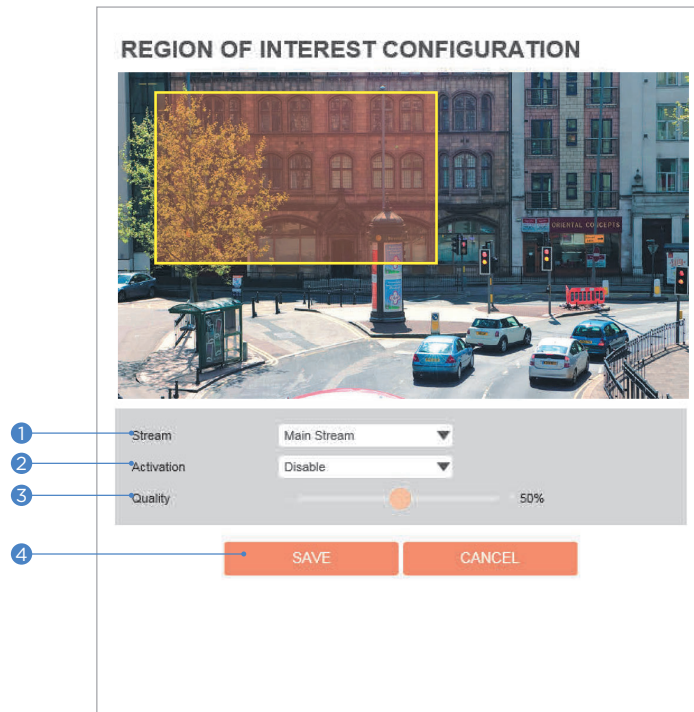

The region of interest function gives a more efficient picture quality for the indicated area to improve the qualities of movement in the scene without compromising the bandwidth.

- 1 **Stream** - Select the Stream.
 - ⚠ Currently supports only H.264, H.265 (HEVC).
 - ⚠ The function is not supported in the MJPEG codec.

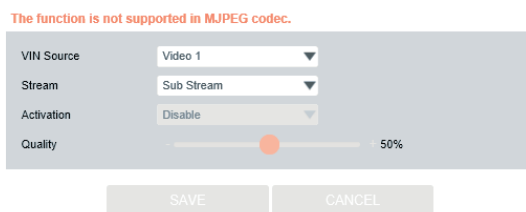

- 2 **Activation** - Enable or disable the region of interest function.
- 3 **Quality** - Set the quality of the set area.
- 4 Click 'Save' to save all settings.
 - ⚠ Click 'Cancel' to return to the previous setting.

Setup - Video & Audio Setup

Privacy Mask Configuration

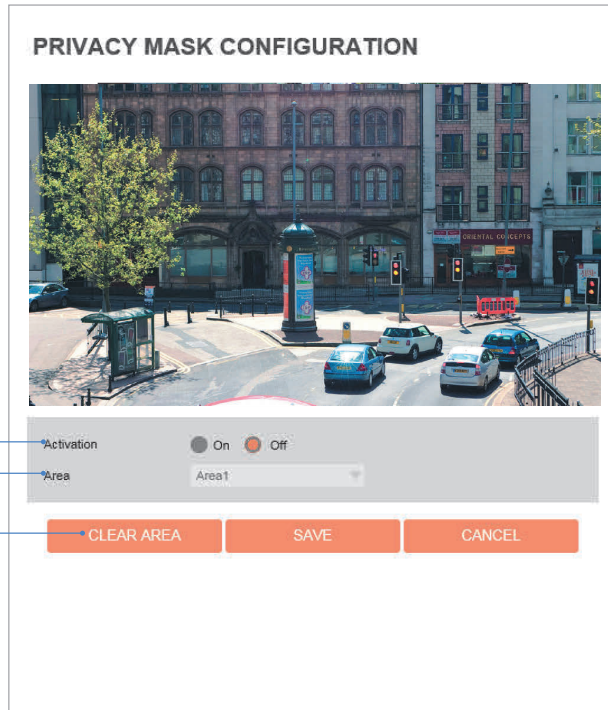

Use this function to mask areas that you want to hide on-screen to protect privacy.

- 1 **Activation** - Enable or disable the privacy mask function.
- 2 **Area** - Select the Area1 - Area16 and Set the privacy area.
- 3 Click 'Save' to save all settings.
 - ⌘ Click 'Cancel' to return to the previous setting.
 - ⌘ Click 'Clear Area' to delete the selected Area1-Area16.

Setup - Camera Setup

Camera Image Adjustment



- 1 **Sharpness** - The higher the number, the sharper the lines in the image will appear.
- 2 **Brightness** - The higher the number, the brighter the image will appear.
- 3 **Contrast** - The higher the number, the stronger the contrast between colors in the image will appear.
- 4 **Saturation** - The higher the number, the more saturated the colors in the image will appear.
- 5 **Hue** - The higher the number, the stronger the hue in the image will appear.
- 6 Click 'Save' to save all settings.
 - ⌘ Click 'Cancel' to return to the previous setting.
 - ⌘ Click 'Default' to settings to the factory defaults.

Setup - Camera Setup

Camera Exposure Settings

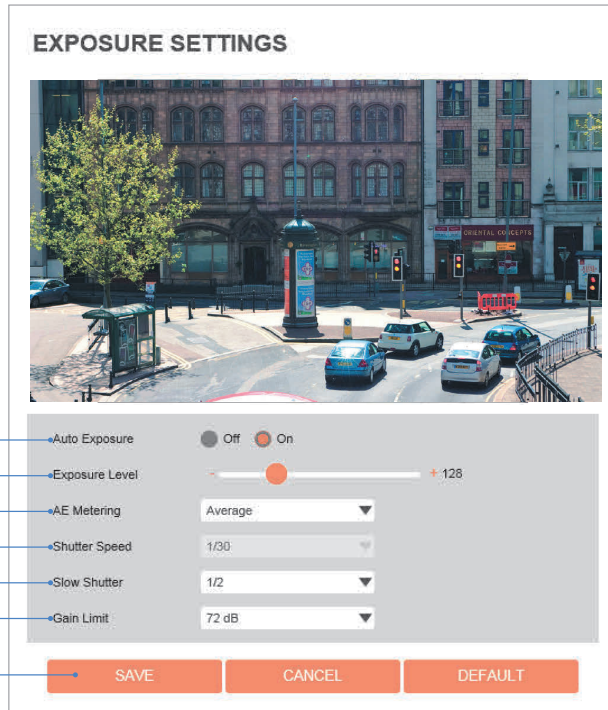

- 1 **Auto Exposure** - Automatic exposure (AE) automatically sets the aperture or shutter speed, based on the external lighting conditions for the photo.
- 2 **Exposure Level** - The higher the number, the brighter the image will appear.
- 3 **AE metering** - AE metering mode refers to how a camera determines the exposure.
- 4 **Shutter Speed** - If this speed is faster, the moving object can be photographed without the ghost effect. However, the picture can be dark if the lighting is insufficient.
- 5 **Slow Shutter Level** - Slow shutter Level lets you adjust the amount of light striking the sensor and essentially determines when the video sensor sends out its batch of data for processing.
- 6 **Gain Limit** - The smaller number makes the darker image.
- 7 Click 'Save' to save all settings.
 - ⌘ Click 'Cancel' to return to the previous setting.
 - ⌘ Click 'Default' to settings to the factory defaults.

Setup - Camera Setup

Camera Day & Night Settings

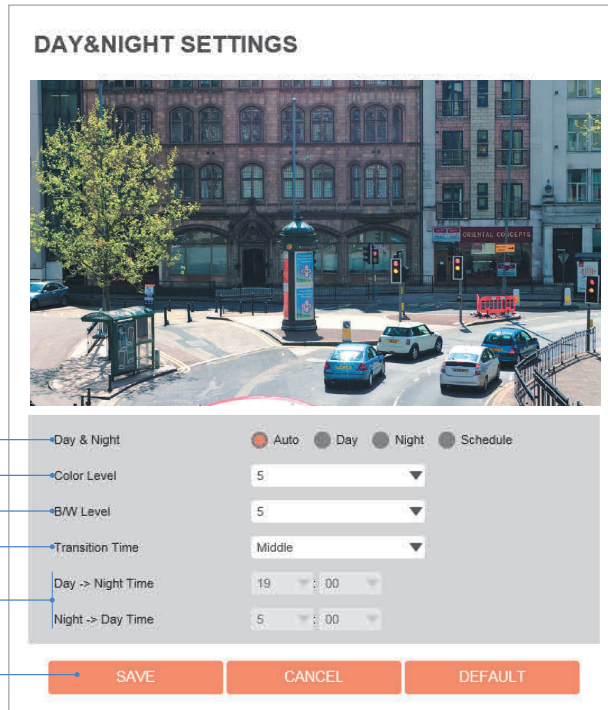

1 Day & Night

- **Auto:** In this mode, the IR cut filter is removed automatically depending on the light condition around.
- **Day:** In this mode, the IR cut filter is applied to the image sensor all the time. Thus, the sensitivity will be reduced in the dark light condition, but the better color reproduction performance is obtained.
- **Night:** In this mode, the IR cut filter on the image sensor is removed all the time. The sensitivity will be enhanced in the dark light condition, but the image is black and white.
- **Schedule:** In this mode, Day / Night mode is converted accordance with the scheduled time.

2 **Color Level** - It is a level to change Night mode into Day mode when Day & Night mode is Auto.

3 **B / W Level** - It is a level to change Day mode into Night mode when Day & Night mode is Auto.

4 **Transition Time** - If it is set to Auto, to determine the rate at which Day / Night is converted.

5 If it is set to schedule mode, Set the time that Day / Night is converted.

6 Click 'Save' to save all settings.

⌘ Click 'Cancel' to return to the previous setting.

⌘ Click 'Default' to settings to the factory defaults.

Setup - Camera Setup

Camera Backlight Settings

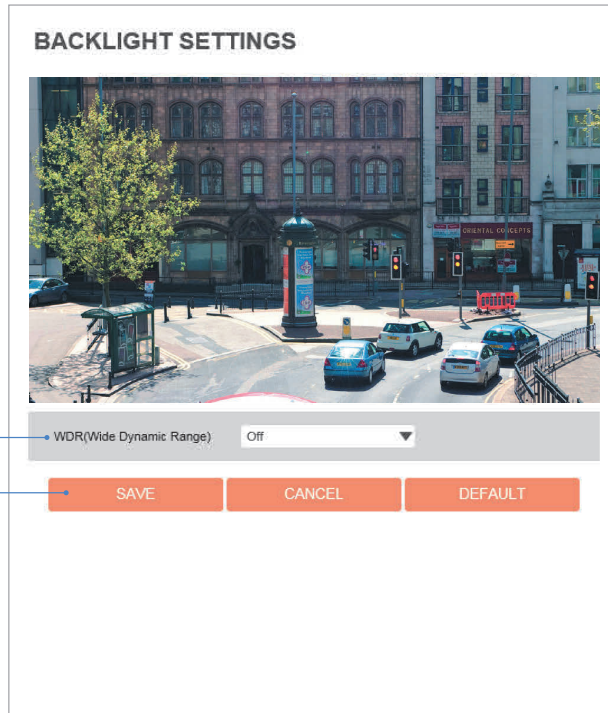

This feature is used when lighting conditions may cause detail loss in the camera's view due to high contrast.

- 1 **WDR (Wide Dynamic Range)** - Enable or disable the WDR function.
- 2 Click 'Save' to save all settings.
 - ⌘ Click 'Cancel' to return to the previous setting.
 - ⌘ Click 'Default' to settings to the factory defaults.

Setup - Camera Setup

Camera White Balance



- 1 **Activation** - Enable or disable the White Balance function
- 2 **White Balance Mode** - Select White Balance depending on the lighting conditions.
- 3 **RGB Gain** - The R/G/B gain can be set only when the White Balance Mode is set to Manual.
- 4 Click 'Save' to save all settings.
 - ⊠ Click 'Cancel' to return to the previous setting.
 - ⊠ Click 'Default' to settings to the factory defaults.

Setup - Camera Setup

Camera Image Enhancement



- 1 **3D Noise Reduction** - 3DNR function suppresses digital noise and retains good video quality in low light conditions.
- 2 **Mirror** - Reverse the video from side to side.
- 3 **Flip** - Reverse the video from up to down.
- 4 Click 'Save' to save all settings.
 - ⌘ Click 'Cancel' to return to the previous setting.
 - ⌘ Click 'Default' to settings to the factory defaults.

Setup - Camera Setup

Video Enhancement

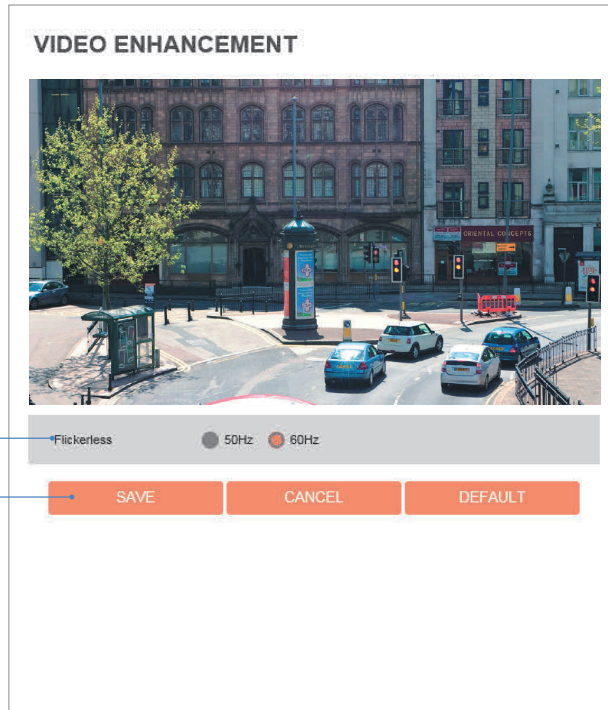

- 1 **Flicker** - In case of flickering video, adjust the flickering values in this menu.
- 2 Click 'Save' to save all settings.
 - ⌘ Click 'Cancel' to return to the previous setting.
 - ⌘ Click 'Default' to settings to the factory defaults.

Setup - Network Setup

Network Status

NETWORK STATUS	
MAC Address	00:0D:D1:11:22:33
IP Address	192.168.1.26
Subnet Mask	255.255.0.0
Default Gateway	192.168.1.1
Preferred DNS Server	192.168.1.1
Alternate DNS Server	
HTTP Port	80
HTTPS Port	443
RTSP Port	554

This menu displays the camera's current network settings. To make any changes to the settings, you must go to the appropriate network settings tab.

Setup - Network Setup

Network Settings

NETWORK SETTINGS

Host Name

Network Type

Static Dynamic

IP setup

IP Address

Subnet Mask

Default Gateway

Preferred DNS Server

Alternate DNS Server

Port Setup

HTTP Port [Default: 80, 1025 ~ 60000]

HTTPS Port [Default: 443, 1025 ~ 60000]

RTSP Port [Default: 554, 1025 ~ 60000]

1 Network Type - Define the network IP address type. Select Static Mode for a fixed IP or Dynamic Mode for a dynamic IP address.

If you select Static Mode, enter the camera's IP Address, Subnet Mask, Gateway, DNS Server, and all ports. If you select Dynamic Mode, the IP address will be assigned automatically by the DHCP network requirements. If you click 'Apply', the system will reboot and you will have to reconnect the camera using the new IP address.

2 IP Address - The camera's IP address consists of four numbers between 0 and 255, separated by dots.

3 Subnet Mask - Define the Subnet Mask. The format is the same as the IP address.

4 Default Gateway - Default the Gateway IP Address. The format is the same as the IP address.

5 Preferred DNS Server - Define the DNS server IP address. The format is the same as the IP address.

6 Alternate DNS Server - Define the Secondary DNS server IP address. The format is the same as the IP address.

7 HTTP Port - The HTTP port can be set to the default 80 port or any value in between 1025 to 60000.

8 HTTPS Port - The HTTPS port can be set to the default 443 port or any value in between 1025 to 60000.

9 RTSP Port - The RTSP port can be set to the default 554 port or any value in between 1025 to 60000.

10 Click 'Apply' to save all settings.

⚠ If the network type is dynamic, the IP address is changed in the following cases. In these cases, the IP address needs to be searched again,

and the camera needs to be reconnected:

- When the camera's power is switched off and on.
- After firmware update, or when the camera is reset to its default settings and reboot.

Setup - Network Setup

Auto IP Settings

AUTO IP SETTINGS

1 General Setting
 Off On

2
UNIQUE ID 2581ad19-e74d-43db-8c49-51bda242355b
AUTO IP ADDRESS 169.254.1.0

3 APPLY

- 1 **General Setting** - Enable or disable the Auto IP Settings.
- 2 **Auto IP Settings Information** - Display the camera's Unique ID and Auto IP address.
- 3 Click 'Apply' to save all settings.

Setup - Network Setup

ONVIF Settings

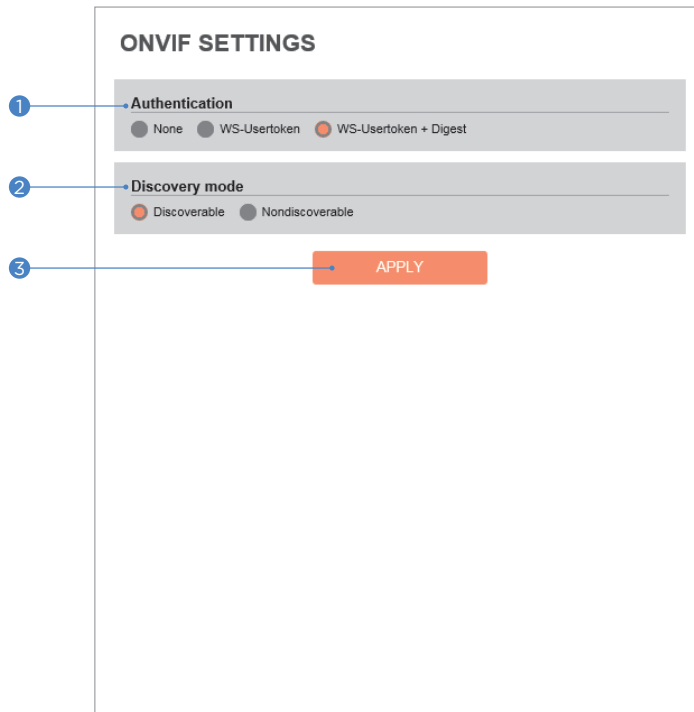

1 Authentication

None: Allow access to the camera without ONVIF authentication.

WS - Usertoken: Allow access to the camera with WS-User Token of ONVIF authentication.

WS - Usertoken + Digest: Allow access to the camera with WS-User Token and Digest of ONVIF authentication.

2 Discovery Mode - Enable or disable discovery mode.

3 Click 'Apply' to save all settings.

Setup - Network Setup

UPNP Settings

The screenshot shows the 'UPNP SETTINGS' interface. It is divided into two main sections: 'General Setting' and 'Device Information'. The 'General Setting' section contains two radio buttons, 'Off' (selected) and 'On'. The 'Device Information' section contains a text input field labeled 'FriendlyName'. Below these sections is an orange 'APPLY' button. Three numbered callouts (1, 2, and 3) point to the 'General Setting' section, the 'Device Information' section, and the 'APPLY' button, respectively.

- 1 **General Setting** - Enable or disable the UPNP function.
- 2 **Friendly Name** - Define the friendly name. Support a maximum of 30 characters and special characters.
 - Do not use: / ~ ! \$ () { } [] ; ,
 - Acceptable special characters include; @ . _ -
- 3 Click 'Apply' to save all settings.

Setup - Network Setup

DDNS Settings

DDNS SETTINGS

Disable

Public DDNS

Address

Host Name

User Name

Password

❶ **DDNS Disable** - If it is selected, DDNS service does not work.

❷ **Public DDNS** - To use public DDNS service, select a site address listed on the list. After filling out the Host Name of the site the setup is completed by entering username and Password registered in that DDNS site.

DDNS Provider	Site Address
DynDNS	www.dyndns.com
No-IP	www.no-ip.com

⚠ If you setup DDNS properly, the IP address of your camera will be updated automatically whenever the IP address is changed or the system is rebooted.

⚠ If IP updating to the DDNS site is failed, the camera will keep retrying in 1min. interval.

❸ Click 'Apply' to save all settings.

Setup - Network Setup

FTP Settings

FTP SETTINGS

General Setting
 Off On

Server information

FTP Server Address

FTP Upload Path

FTP Port

User ID

Password

APPLY

To transfer/save the image to the relevant sites through FTP, then FTP needs to be setup.

- 1 **General Setting** - Enable or disable the FTP function.
- 2 **FTP Server Address** - Define FTP Server IP Address. If the IP Address form is incorrect, a message box will be shown to try again.
- 3 **FTP Upload Path** - Define a path in FTP server to store video. For the path name, English Alphabets, numbers and special characters (/ - ! @ \$ ^ () _ - { } [] ; ,) can be used.
- 4 **FTP Port** - Define the FTP Server Port. If Port is not appropriate, it is impossible to access to FTP Server.
- 5 **User ID** - Define User ID to access to the FTP Server. Fill out the correct User ID registered in the FTP Server.
- 6 **Password** - Define Password to access to the FTP Server. Fill out the correct Password registered in the FTP Server.
- 7 Click 'Apply' to save all settings.
 - ⌘ Refer to the above image for example.

Setup - Network Setup

SMTP Settings

The screenshot shows the 'SMTP SETTINGS' configuration page. It is divided into three main sections: 'General Setting', 'Account information', and 'Mail Contents'.
1. 'General Setting' has a radio button for 'Off' (selected) and 'On'.
2. 'Account information' has a radio button for 'Mode' set to 'PLAIN' (selected) and 'SSL/TLS'.
3. 'Account information' includes text input fields for 'SMTP Server Address', 'PORT' (with '25' pre-filled), 'User ID', 'Password', 'E-Mail Sender', and 'E-Mail Receiver'.
4. 'Mail Contents' includes a text input field for 'Title' and a larger text area for 'Message'.
5. An orange 'APPLY' button is located at the bottom right of the form.

To send/save the image to the relevant sites by Email, SMTP needs to be setup.

- 1 **General Setting** - Enable or disable the SMTP function.
- 2 **Mode** - Select the security mode of SMTP from Plain or SSL / TLS. After checking the account setup of your SMTP Server, you may select one.
- 3 **SMTP Server Address** - Define the SMTP Server Address. If the IP Address form is incorrect, a message box will be shown to try again.
- 4 **Port** - Define the Port used in the Plain or SSL / TLS security mode in the above.
- 5 **User ID** - Define the User ID to access the SMTP Server. Fill out the correct User ID registered in the SMTP Server.
- 6 **Password** - Define the Password to access the SMTP Server. Fill out the correct Password registered in the SMTP Server.
- 7 **E-Mail Sender** - Define the e-mail address of the E-Mail Sender. It will be displayed as the sender when the camera sends an E-mail.
- 8 **E-Mail Receiver** - Define the e-mail address of E-Mail Receiver. It will be displayed as the Receiver when the camera sends an E-mail.
- 9 **Title** - Define the title of the E-Mail when the camera sends an E-mail.
⚠ The title of the Email is limited to 40 characters including the spaces.
- 10 **Message** - Define the contents of E-Mail when the camera sends an E-mail. The message of the Email is limited to 40 characters including the spaces.
- 11 Click 'Apply' to save all settings.

Setup - Network Setup

SNMP Settings

The screenshot shows the 'SNMP SETTINGS' configuration page. It is divided into three main sections: 'SNMP v1/v2c', 'SNMP v3', and an 'APPLY' button at the bottom. Callouts 1 through 9 point to the following elements:

- 1: Points to the 'SNMPv1' and 'SNMPv2c' radio buttons in the 'SNMP v1/v2c' section.
- 2: Points to the 'TrapAddress' text input field in the 'SNMP v1/v2c' section.
- 3: Points to the 'Mode' dropdown menu in the 'SNMP v3' section.
- 4: Points to the 'Activation' radio buttons in the 'SNMP v3' section.
- 5: Points to the 'Read Name' text input field in the 'SNMP v3' section.
- 6: Points to the 'Security Level' dropdown menu in the 'SNMP v3' section.
- 7: Points to the 'Authentication Algorithm' dropdown menu in the 'SNMP v3' section.
- 8: Points to the 'Authentication Password' text input field in the 'SNMP v3' section.
- 9: Points to the 'APPLY' button at the bottom of the page.

1 **SNMPv1/SNMPv2** - Select the SNMPv1/SNMPv2 option and type the names of Read and Write communities.

SNMP trap can be used to check periodically for operational thresholds or failures that are defined in the MIB.

2 **SNMP Trap** - Enable or disable the SNMP trap.

SNMPv3 contains cryptographic security, a higher security level, which allows you to set the Authentication password and the Encryption password.

3 **Mode** - Select the either Read or Read/Write mode.

4 **Activation** - Select mode to enable or disable.

5 **Read/Write name** - Define Read name and Write name.

6 **Security Level** - Select one of no auth, no priv/auth , no priv/auth, priv

7 **Authentication Algorithm** - Select MD5 or SHA as the authentication method.

8 **Authentication Password** - The Authentication Password is encryption for authentication and they are at least 8 digits and up to 30 digits allowed.

9 Click 'Apply' to save all settings.

Setup - Network Setup

RTSP Information

The screenshot shows the 'RTSP INFORMATION' configuration page. It is divided into several sections: 'RTSP Global Setting' with a 'Target Stream' dropdown set to 'Main Stream'; 'Session Timeout' with a 'Time Out' input field set to '0' and a checkbox for '[Default:Off, 30~120]'; 'QoS Setting' with a 'DSCP' input field set to '0' and a range of '[0~255]'; and 'Rtp Multicast' with a 'MULTICAST' section containing radio buttons for 'Stop' (selected) and 'Start', and three input fields for 'IP' (0.0.0.0), 'PORT' (0, range [1024~60000]), and 'TTL' (0, range [1~255]). Below these is an orange 'APPLY' button. At the bottom, a table shows RTSP connection information.

No	Remote IP	Port	Type
1	192.168.4.100	53449	TCP

- 1 Target Stream** - Select the stream you want to set.
- 2 Time out** - Set the RTSP time out.
 - ⚠ The session is disconnected after the specified time out.
- 3 QoS Setting** - Set the quality of service to ensure data transfer performance.
- 4 RTP Multicast** - Check RTP Multicast Start/Stop. To activate RTP Multicast.
 1. Click the “On” button.
 2. Enter accessible RTP Multicast IP, the port for video stream control, RTP packet TTL.
 3. Click the “Apply” button.
 - ⚠ It is possible to set each RTP Multicast for CH1-3.
- 5** Click ‘Apply’ to save all settings.
 - ⚠ Click this button when completed setup each channel.
- 6** It shows RTSP Connection information.

Setup - Trigger Action Setup

Action Rules Configuration

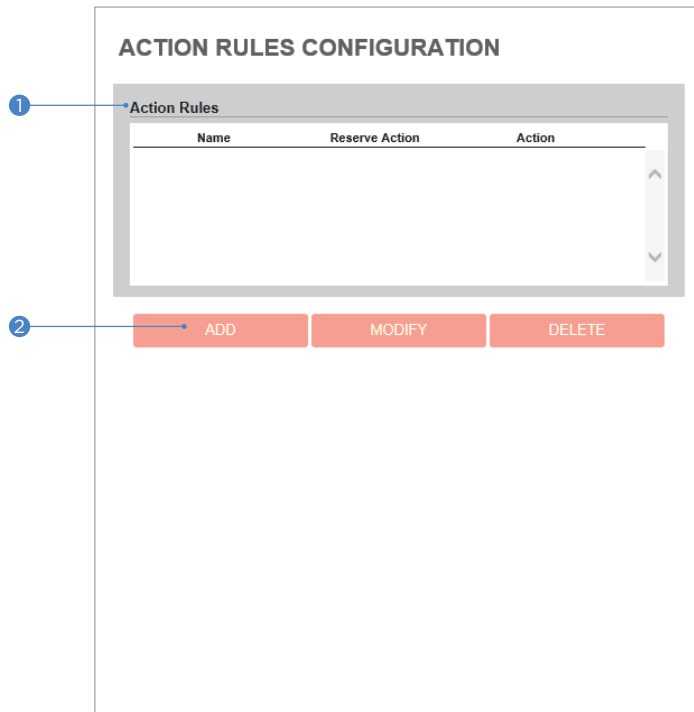

- 1 **Action rules List** - It indicates the custom action rule information added to the Action rules list.
- 2 Click 'Add' to add custom action rules.
 - ⊠ Click 'Modify' to modify selected items from the action rules list.
 - ⊠ Click 'Delete' to delete selected items from the action rules list.

Setup - Trigger Action Setup

Action Rules Add / Modify

The screenshot displays the 'ACTION RULES CONFIGURATION' interface. It features a table titled 'Action Rules' with three columns: 'Name', 'Reserve Action', and 'Action'. The table contains three rows of data. Below the table are three buttons: 'ADD', 'MODIFY', and 'DELETE'. Two callout boxes are present: callout 1 points to the 'Name' column header, and callout 2 points to the 'Reserve Action' column header.

Name	Reserve Action	Action
SMTP	1 / 5	SMTP
FTP	1 / 5	FTP
RECORD	1 / 5	RECORD

ADD MODIFY DELETE

- 1 **Name** - Define the name of the action rules.
 - ⊠ Input text cannot exceed the limit (3-15 characters).
- 2 **Action1 ~ Action5** - Select the action to take if the event occurs.

Setup - Trigger Action Setup

Image Transfer Configuration

IMAGE TRANSFER CONFIGURATION

1. Add the FTP/SMTP action in the event rules menu.
2. When an event occurs, the images will be sent to ftp/smtp address .
3. Determine the image transfer speed and the duration of image transfer after/before an event.

1 **Pre/Post Alarm Image**

Number Of Image	<input type="text" value="2"/>	Image Per Seconds(s) [1 ~ 5]
Pre-Alarm Duration	<input type="text" value="3"/>	Second(s) [1 ~ 5]
Post-Alarm Duration	<input type="text" value="3"/>	Second(s) [1 ~ 30]

2

- 1 **Pre / Post Alarm Image** - Image Transfer due to event is configured by setting Image transfer rate and Pre / Post alarm duration.

	Descriptions
Number of Images	Define the number of images transferred per second.
Pre-alarm Duration	Define the duration of the image transfer before an event.
Post-alarm Duration	Define the duration of the image transfer after an event.

- 2 Click 'Apply' to save all settings.

Setup - Event Setup

Event Rules Configuration

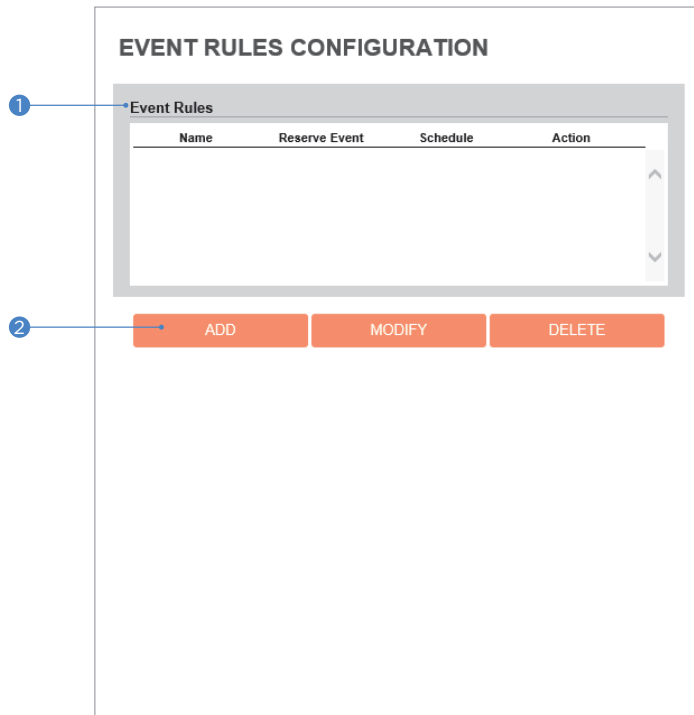

- 1 **Event Rules List** - It indicates the custom Event Rule information added to the Event Rules list.
- 2 Click 'Add' to add custom event rules.
 - ⌘ Click 'Modify' to modify selected items from the event rules list.
 - ⌘ Click 'Delete' to delete selected items from the event rules list.

Setup - Event Setup

Event Rules Configuration

The screenshot shows the 'EVENT RULES CONFIGURATION' form. It is divided into three main sections: 'General', 'Event Condition', and 'Action'.
1. The 'General' section has a 'Name' field with the text 'NewRule'.
2. The 'Event Condition' section has an 'Event' dropdown menu currently set to 'NONE'.
3. The 'Action' section has a 'Rules' dropdown menu currently set to 'NONE'.
4. At the bottom of the form are two orange buttons: 'SAVE' and 'CANCEL'.
Four blue callout lines with circular numbers 1 through 4 point to the Name field, the Event dropdown, the Rules dropdown, and the SAVE button respectively.

- 1 **Name** - Define the Event rule name.
- 2 **Event** - Select the event among motion detection, network disconnection, illegal login detected, temperature critical, schedule, sensor detection.
 - ⊠ Click 'Cancel' to return to the previous setting.
 - ⊠ You need at least one event.
- 3 **Rules** - Select the action rule defined in the Trigger Action-Action rule menu.
- 4 Click 'Save' to save the current settings.
 - ⊠ Click 'Cancel' to return to the previous setting.

Setup - Event Setup

Motion Detection Configuration

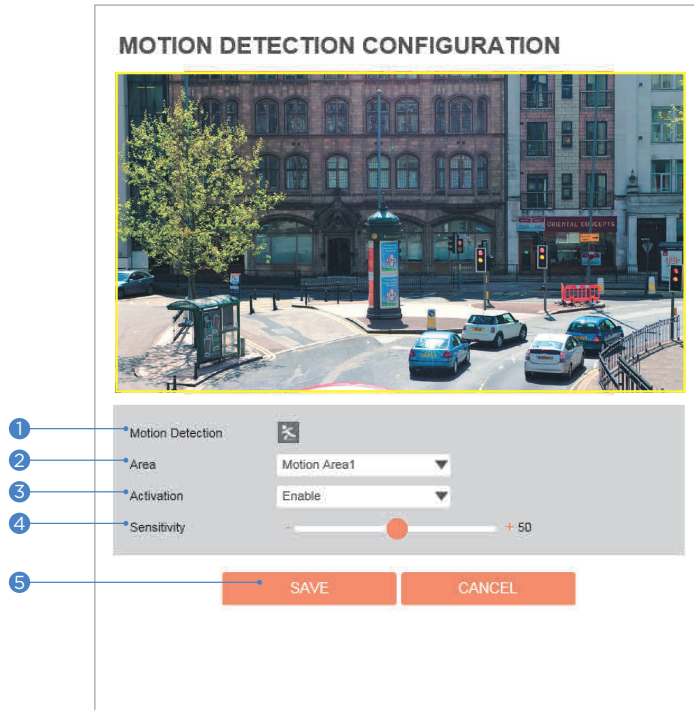

- 1 Motion Detection** - It shows the Motion event status.
 - ⌘ Event Alert Icon() appears if 'Motion Detection' is activated.
- 2 Area** - Set the motion detected area. Click in the display window to draw the motion area.
 - ⌘ You can set up to four areas.
- 3 Activation** - Enable or Disable motion detection function.
- 4 Sensitivity** - Define the sensitivity of motion detection.

If High value is selected, it will detect very small motion while it becomes relatively insensitive when Low value is selected.
- 5** Click 'Save' to save all settings.
 - ⌘ Click 'Cancel' to return to the previous setting.

Setup - Event Setup Temperature

The screenshot shows a web interface titled "TEMPERATURE" with a "General Setting" section. The settings are as follows:

Field	Value
Mode	Fahrenheit
Threshold	150 [122 ~ 212]
Temperature	113 °F

An orange "APPLY" button is located at the bottom of the settings panel. Four numbered callouts (1-4) point to the Mode dropdown, the Threshold input field, the Temperature display, and the APPLY button, respectively.

- 1 **Mode** - Select Fahrenheit or Celsius.
- 2 **Threshold** - Define the temperature at which the event trigger occurs.
- 3 **Temperature** - It indicates the current temperature of the IP camera.
- 4 Click 'Apply' to save all settings.

Setup - Security Setup

IP Address Filter Configuration

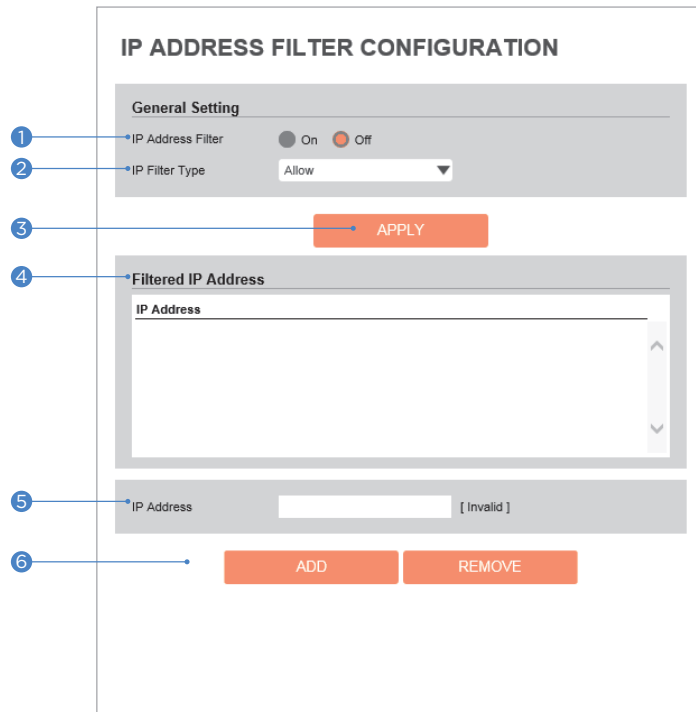

- 1 **IP Address Filter** - Enable or disable the IP filter function.
- 2 **IP Filter Type** - Select the recording IP filter type.
- 3 Click 'Apply' to save the settings.
- 4 **Filter IP Address** - Display the filtered IP address.
- 5 **IP Address** - Define the IP address you want to apply the IP filter.
- 6 Click 'Add' to add the IP address to the list.
 - ⌘ Click 'Remove' to remove the IP address selected in the list.
 - ⌘ Click 'Remove All' to remove all IPs on the list.

Setup - Security Setup

RTSP Authentication Configuration

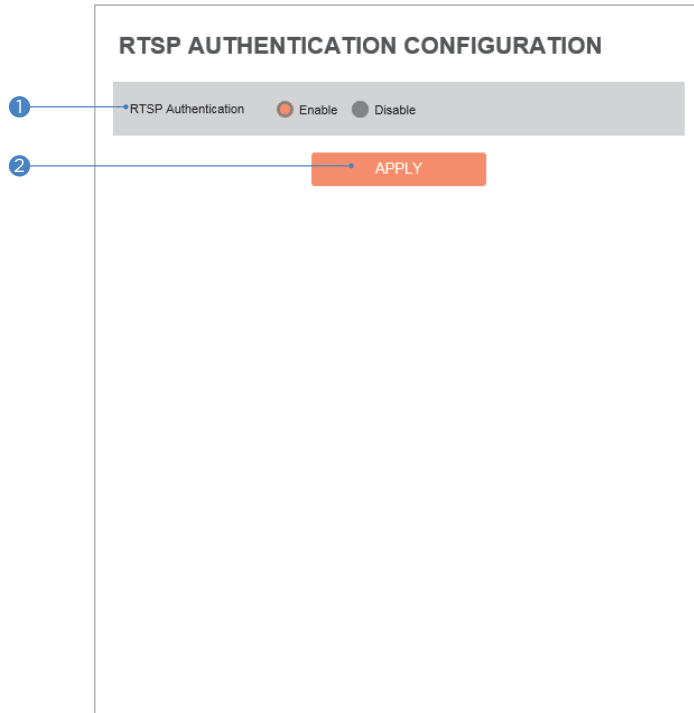

- 1 **RTSP Authentication** - Enable or disable the RTSP authentication.
- 2 Click 'Apply' to save all settings.

Setup - Security Setup

IEEE 802.1X Configuration

IEEE 802.1X CONFIGURATION

General Setting

- 1 IEEE 802.1x On Off
- 2 Protocol MD5
- 3 EAPOL Version 1
- 4 ID
- 5 Password
- 6 Retype Password
- 7 CA Certificate NONE
- 8 Certificate NONE
- 9 APPLY

The feature is needed when connecting the camera to the network protected by the IEEE 802.1X.

- 1 **IEEE 802.1x** - Enable or disable the IEEE 802.1x feature.
- 2 **Protocol**
 - MD5: It provides one-way password-based network authentication of the client.
 - PEAP: It is similar to TTLS in that it does not require a certificate on the client-side.
 - TTLS/MD5: It does not require a certificate on the client-side.
 - TLS: It relies on client-side and server-side certificates to perform authentication.
- 3 **EAPOL Version** - Select the EAPOL Version.
- 4 **ID** - Type the ID to identify the client in the IEEE 802.1X authentication server.
- 5 **Password** - Type the Password to identify the client in the IEEE 802.1X authentication server.
- 6 **Verify** - Verify Password.
- 7 **CA Certificate** - Select the CA certificate required for TLS, TTLS, and PEAP authentication.
- 8 **Certificate** - Select the client certificate required for TLS authentication
- 9 Click 'Apply' to save all settings.

Setup - Security Setup

HTTPS Configuration

The screenshot shows the 'HTTPS CONFIGURATION' interface. At the top, there is a red warning message: '1. If no certificates are available go to certificates to manage.' Below this, there are two main sections: 'Certificates' and 'HTTPS connection Policy'. The 'Certificates' section has a 'Certificate' dropdown menu currently set to 'NONE', with a blue callout '1' pointing to it. The 'HTTPS connection Policy' section has three dropdown menus: 'WEB' set to 'HTTP and HTTPS', 'ONVIF' set to 'HTTP', and 'RTSP OVER HTTP' set to 'HTTP', with a blue callout '2' pointing to the 'ONVIF' dropdown. At the bottom of the configuration area is an orange 'APPLY' button, with a blue callout '3' pointing to it.

HTTPS encrypts session data over SSL or TLS protocols instead of using plain text in socket communications.

- 1 **Certificate** - Select an installed certificate.
 - ⊗ If you cannot select a certificate, please install the certificate from the Security->Certificates menu.
- 2 **HTTPS connection Policy** - Select one of "HTTP", "HTTPS", "HTTP and HTTPS" depending on the connected web, ONVIF, RTSP over HTTP.
 - WEB: "HTTP" "HTTPS" "HTTP and HTTPS"
 - ONVIF, RTSP OVER HTTP: "HTTP" "HTTPS" "HTTP and HTTPS"
- 3 Click 'Apply' to save all settings.
 - ⊗ When HTTPS mode is chosen, input https://<IP Address> to connect to the camera.

Setup - Security Setup

Certificates Configuration

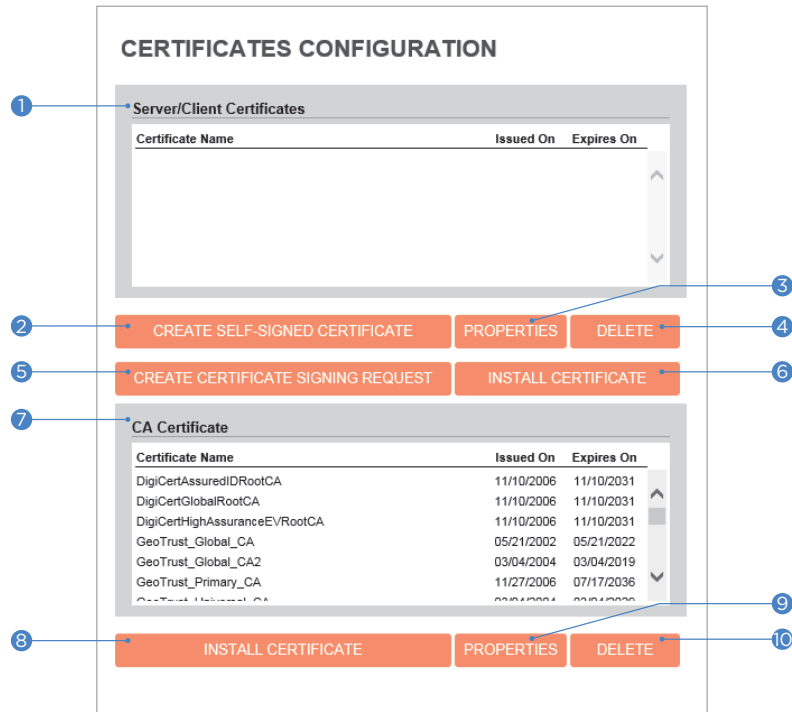

- 1 **Server/Client Certificates** - Shows the installed certificates.
- 2 **Create Self-Signed Certificate** - A self-signed SSL certificate is an identity certificate signed by its creator. But they are considered to be less trustworthy.
- 3 **Properties** - Shows information about the selected certificate.
- 4 **Delete** - Delete the selected certificate.
- 5 **Create a Certificate signing request** - This is the encoded data that contains the necessary information for issuing the certificate.
 - ※ They must be filled in when creating the CSR (Certificate Signing Request).
- 6 **Install Certificate** - Install Certification
- 7 **CA Certificate** - Shows the installed CA certificates.
- 8 **Install CA Certificate** - Install Certification, see the detail page.
- 9 **Properties** - Shows information about the selected certificate.
- 10 **Delete** - Delete the selected CA certificate.

Setup - Security Setup

Certificates Configuration

CERTIFICATES CONFIGURATION

Create Self-Signed Certificate

Certificate Name:

Expires On: ~01/18/2038

Country:

State Or Province:

Locality:

Organization:

Organization Unit:

Common Name:

RSA:

SHA:

Alternative Hostname1:

Alternative Hostname2:

Alternative IP:

Install Certificate

Certificate From Signing Request

Certificate And Private Key

Certificate Name:

Certificate File:

Install CA Certificate

Certificate Name:

Certificate File:

Callouts: 1 (radio), 2 (radio), 3 (text), 4 (button), 5 (OK), 6 (CANCEL), 7 (text), 8 (button), 9 (OK), 10 (CANCEL)

Detail for Install Certification.

- 1 **Certificate From Signing Request** - Select to install a signed certificate returned from the CA.
- 2 **Certificate And Private Key** - Select to install Certificate And Private Key to install a certificate and private key.
- 3 **Certificate Name** - Enter a unique name to identify a certificate.
- 4 **Select File** - Choose the certification file.
- 5 **OK** - Request installing a certificate.
- 6 **Cancel** - Cancel install certificate and then back to certificates configuration.

Detail for Install CA Certification.

- 7 **Certificate Name** - Enter a unique name to identify CA certificate.
- 8 **Select File** - Choose a CA certification file
- 9 **OK** - Request installing a CA certificate.
- 10 **Cancel** - Cancel installing a CA certificate and then back to certificates configuration.

Setup - Security Setup Service Configuration

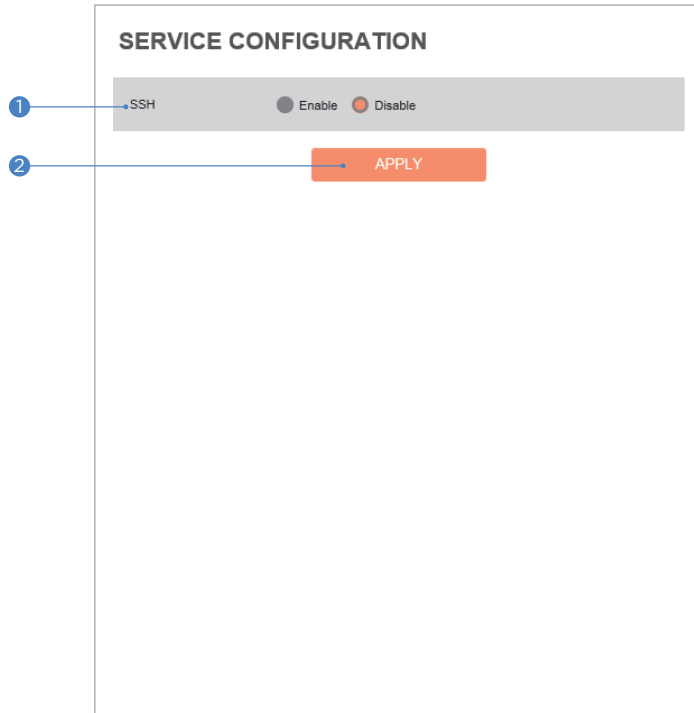

- 1 **SSH** - Enable or disable the SSH function.
- 2 Click 'Apply' to save all settings.

Setup - System Setup

System Information

SYSTEM INFORMATION

1 Device Name
Location

2

Model Name	NFN1-SLCH5
Manufacturer	Digital Watchdog
Max Resolution	2592 x 1944
Max Framerate	30 fps
Photo Resistor(CDS)	SUPPORT
Alarm In	SUPPORT
Relay out	SUPPORT
Audio	SUPPORT
Optical Zoom	X5
Digital Zoom	NOT SUPPORT
PTZ	NOT SUPPORT

System Capability information.

- 1 **Device Name** - You can define the device name.
- 2 Click 'Apply' to save all settings.

Setup - System Setup

System Diagnostics

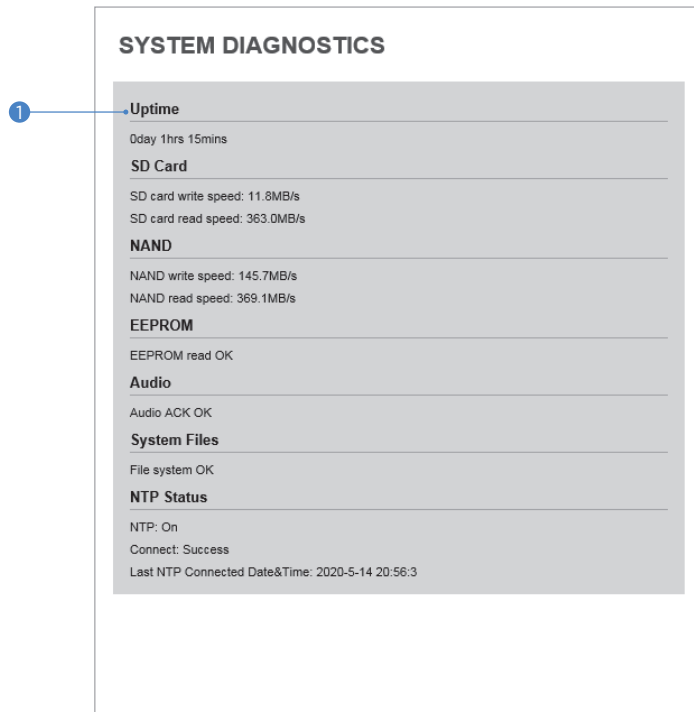

Shows basic hardware functions after inspection.

1 Shows Uptime, SD card, NAND, EEPROM, Audio chip, Important file system, and NTP Status.

⚠ Warning:

If the camera is abnormally terminated, a download button will appear on the diagnostics page to download a file that allows you to check the error information you can.



Setup - System Setup Firmware Update

FIRMWARE UPDATE

1. Do not power off during update. It may cause fatal system damage.
2. If Explorer was closed abnormally or a user closed it accidentally while uploading firmware file, please try again after 30 seconds.
3. Please do not select other menus while updating firmware file.

Version Information

System	2020.04.13_A13.2.1
Camera	-

Web update

Firmware File

FTP user information

FTP Server Address	<input type="text" value="ftp.dwcc.tv"/>
FTP Port	<input type="text" value="21"/>
User ID	<input type="text" value="dwmpix"/>
Password	<input type="password" value="*****"/>
FTP Upload Path	<input type="text" value="/"/>

① **Version Information** - It shows the current Firmware Version in the system.

② **Web Update** - Select the Firmware file in your computer by clicking [Select file] button.

③ **Start F / W Update** - Click this button to start the update. Progress of uploading will be displayed using Progress Bar. If you assign the wrong file name, an error message will be shown.

⚠ **Warning:**

1. Do not turn off the power to the camera during the Firmware update. Otherwise, the system can get stuck to become unstable. Once the update is completed, the system will reboot automatically.
2. Make sure to check the 'Notice' shown on screen.
If the firmware update is completed successfully, the camera will reboot and show the login window.

Setup - System Setup

Date & Time Settings

The screenshot shows the 'DATE&TIME SETTINGS' interface. It is divided into three main sections: 'TimeZone Setup', 'Time Format', and 'Current Date & Time'. Each section has an 'APPLY' button below it. Callout 1 points to the 'TimeZone Setup' section, which includes a 'TimeZone' dropdown menu set to '(GMT-08) Pacific Time (US & Canada), Baja California'. Callout 2 points to the 'Time Format' section, which includes a 'Time Format' dropdown menu set to 'mm/dd/yy'. Callout 3 points to the 'Current Date & Time' section, which shows the current date and time as '05/14/2020 21:13:14'. Below this is the 'New Camera Date & Time' section, which has three radio button options: 'Synchronize with my computer' (unselected), 'Setup manually' (unselected), and 'Synchronize with time server (NTP)' (selected). The 'Synchronize with my computer' option has a 'Date & Time' field set to '05/15/2020 13:13:14'. The 'Setup manually' option has 'Date' fields set to '2005 01 01' and 'Time' fields set to '00 00 00'. The 'Synchronize with time server (NTP)' option has an 'NTP Server' dropdown menu set to 'pool.ntp.org'. Callout 7 points to the 'APPLY' button at the bottom of the 'Current Date & Time' section.

- 1 **TimeZone Setup** - Choose the time zone for the camera. It will be activated after clicking the 'Apply' button.
 - ⚠ Before setting below 'New Camera Date and Time', set correct Timezone first.
- 2 **Time Format** - Select the time format yy-mm-dd or mm/dd/yy.
- 3 **Current Date and Time** - Shows the current date and time setting in the Camera.
- 4 **Synchronize with my computer** - Set the date/time using those of PC currently connected.
- 5 **Setup manually** - Set the date/time by typing manually.
- 6 **Synchronize with time sever Time Zone (NTP)** - Choose time server available to connect to the current camera. Date and Time will be updated automatically every hour when connected.
- 7 Click 'Apply' to save all settings.

Setup - System Setup

DST Settings

The screenshot shows the 'DST SETTINGS' configuration page. It is divided into two main sections: 'General Setting' and 'Date&Time Settings'. The 'General Setting' section has two radio buttons: 'Off' (selected) and 'On'. The 'Date&Time Settings' section has two rows of dropdown menus. The first row is for 'Start Time' with values: Mar, Second, Sun, 2, o'clock. The second row is for 'End Time' with values: Nov, First, Sun, 2, o'clock. At the bottom of the settings area is an orange 'APPLY' button. Three blue callout lines with circular numbers 1, 2, and 3 point to the 'General Setting' section, the 'Date&Time Settings' section, and the 'APPLY' button, respectively.

Daylight Saving Time (DST) is the practice of setting the clocks forward one hour from standard time during the summer months, and back again in the fall, to make better use of natural daylight.

- 1 **General Setting** - Enable or disable the DST function.
- 2 **Date and Time Settings** - Set the start time and end time that the DST applies.
- 3 Click 'Apply' to save all settings.

Setup - System Setup

Users Management

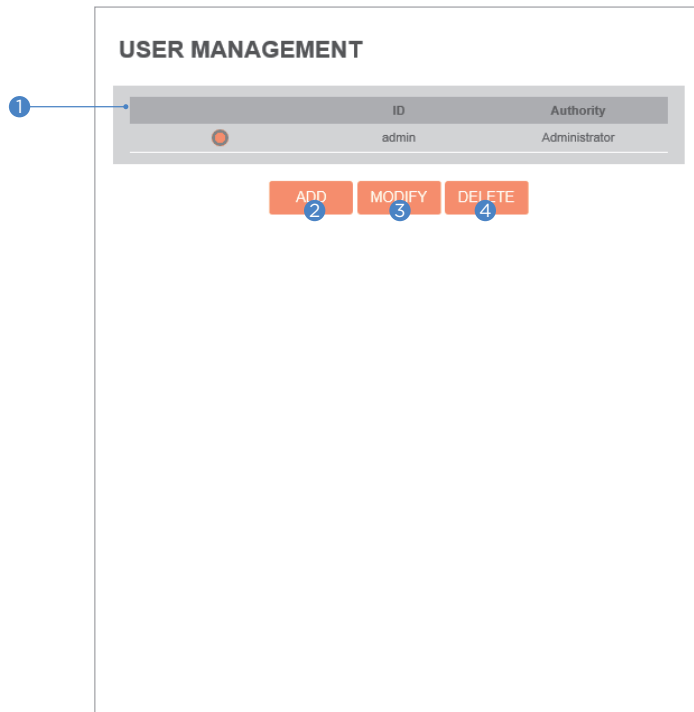

1 **Users** - List all the user accounts for authentication.

2 **Add** - Register a new user.

ID	<input type="text"/>
Password	<input type="password"/>
Retype Password	<input type="password"/>
Password Hint	<input type="text"/>
UserAuthority	Operator

Password requirement: minimum 8 characters with at least three combinations of uppercase letters, lowercase letters, numbers and special characters. Acceptable special characters are: ~ ! \$ ^ () _ - { } [] ; . ? /

ID	Enter a new user ID. Admin already exists.
Password	Enter the user password. (Check the password)
Retype Password	Enter the user password again for verification.
Password Hint	Enter the password hint.
User Authority	Select Operator or Viewer. Viewer: Only monitoring is allowed. Operator: Most of the functions are allowed except 'Setup'.

- ⚠ The ID and Password are limited to 8 characters with at least two combinations of uppercase letters, lowercase letters, numbers and special characters.
Acceptable special characters are: ~ ! \$ ^ () _ - { } [] ; . ? /

Click 'Save' to save all settings.

- ⚠ Click 'Cancel' to return to the previous menu.

3 **Modify** - Modify the information of the user accounts registered. For the admin account, only Password function can be modified.

4 **Delete** - Delete the selected user account. The admin account cannot be deleted.

Setup - System Setup

System Log

SYSTEM LOG

1 **Filter**

Date 05/15/2020 ~ 05/15/2020

Time 0 0 0 ~ 0 0 0

Type All

Sort Ascending

2 **REFRESH** **FILTER** **BACKUP**

3 **List**

Date & Time	Log	IP
05/14/2020 21:13:13	Login Success	IP 192.168.4.100
05/14/2020 21:12:52	Motion detected : 01 : On	system
05/14/2020 21:12:10	Motion detected : 01 : On	system
05/14/2020 21:04:59	Motion detected : 01 : On	system
05/14/2020 21:04:08	Motion detected : 01 : On	system
05/14/2020 21:02:06	Motion detected : 01 : On	system
05/14/2020 21:02:06	Login Success	IP 192.168.4.100
05/14/2020 21:02:03	RTSP session connected	192.168.4.100
05/14/2020 21:02:02	Motion detected : 01 : On	system

1 2 3

- 1 **Filter** - Select a date, time, sort, or type of log to filter the log.
- 2 Click the 'Refresh' button to refresh the log list.
 - ⌘ Click 'Filter' to view the filtered log.
 - ⌘ Click 'Backup' to backup the filtered log.
- 3 **System Log List** - The filtered log is displayed.

Setup - System Setup

Factory Reset

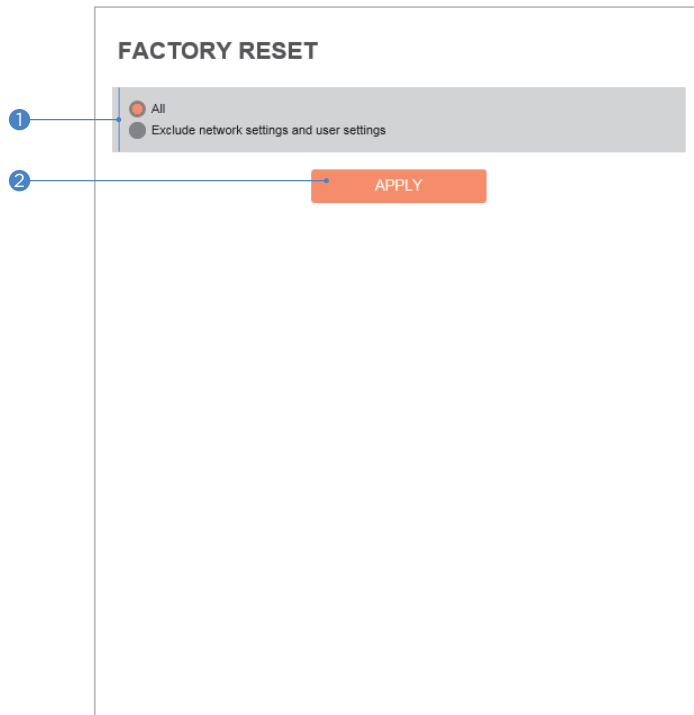

- 1 **Reset to the factory defaults** - Return the setup to the factory default.

All - Reset all Settings to the factory defaults.

Except Network Settings and User Settings - Reset all camera settings to factory default except for the network settings.

- 2 Click 'Apply' to save all settings.

Setup - System Setup

Restart

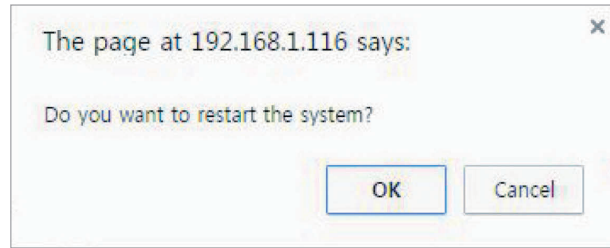

If you click the 'RESTART' menu, a message box will be shown to confirm. Click the 'OK' button to restart.

Setup - System Setup

System Open Source License

SYSTEM OPEN SOURCE LICENSE

Open Source Name	Version	License
busybox	1.32.0	GPLv2
alsa-lib	1.1.6	GPLv2.1
libglib2	2.52.3	LGPLv2
libgnutls	3.6.2	LGPLv2.1
libjson-c	0.13.1-20180305	JSON License
libcurl	7.66.0	MIT/X derivate License
libffi	3.1	MIT License
libgcrypt	1.6.1	LGPLv2.1
libnl	3.4.0	LGPLv2.1
libogg	1.3.2	BSD-style License
libsamplerate	0.1.8	GPLv2
libselinux	2.7	Public domain
libsndfile	1.0.27	LGPLv2.1
libssh2	1.9.0	BSD
libtasn1	4.13	GPLv3

This menu will show you all the list of System Open Source License in the camera.
Open Source Name / Version / License.

Network Setup - Quick Start of Network Connection

Follow the steps below to complete the initial network setup.

- i** Do not power on the IP camera until instructed.
- i** Temporarily disable any proxy servers configured in internet Explorer.
- i** If connecting the IP camera directly to a modem, power down and reset the modem. Leave the modem powered down until the camera's configuration is complete and the IP Camera has been connected to the modem.

- 1 Connect the IP camera to the configured network.
- 2 Open the DW IP Finder on a PC on the same network as the camera and search for the camera.

- i** If you have a DHCP server, it will automatically set the camera's IP address and network settings.
- i** If you do not have a DHCP server, the camera's IP address is set by default to 192.168.1.80 after one minute. In this case, the PC's IP address must be changed to match the camera's IP address settings to be able to access the camera.

- 3 If multiple cameras are added at the same time, each camera can be identified by its mac address.
- 4 Click on the camera's IP address and connect to the web page.
- 5 Default ID/password are both: admin.
- 6 Familiarize yourself with the viewer interface.
- 7 Install VLC to display live video.
- 8 The camera's IP address settings can be set to 'STATIC' from the DW IP Finder or the camera's web viewer by going to Setup -> Network -> Network Settings.
- 9 If the IP camera is connected to a network with a router, you must have port forwarding configured on your router to access the camera from outside the network.
- 10 After configuring port forwarding on your router (if necessary), access your IP camera by opening Internet Explorer and typing the IP address and web port assigned to the IP camera.

- i** Example: <http://192.168.0.200:8888>
- i** If your web port is 80, you do not need to specify the port in the address bar to access to your IP camera.

- 11 Access your IP Camera via the Internet (from a different network from the one your camera is):

If you use a static IP address assigned by your ISP:

1. Open Internet Explorer.
2. Type the address of the IP camera.
3. If you use a router, enter the routers' static IP and the web port number of the IP camera.

If you have a dynamic address provided by your ISP

1. Open Internet Explorer and go to your DDNS website.
 2. Register the IP camera.
 3. Reboot the IP camera.
 4. Give the DDNS server 10 minutes to locate your IP camera's IP information.
 5. Click the refresh button in Internet Explorer.
 6. After your camera is connected, select your camera.
-

Network Setup - DDNS Registration

If you have a DYNAMIC IP service from your Internet Service Provider (ISP), you can't tell the current IP address of the IP Camera. To solve this problem, you have to register with our DDNS service.

At first, you have to check if you are using dynamic addressing. If so, register your IP Video Server on our DDNS website before you configure, setup, or install the IP Camera.

Even though your IP is not dynamic, you will get benefit if you register to DDNS. In this case, just remember 'hostname.dyndns.com/gate1' instead of a complicated series of numbers like `http://201.23.4.76:8078`.

For more details, contact our Support Center.

✉ To use a public DDNS called 'DynDNS' or 'no-IP', refer to the detailed information on how to use the service. (Visit: <http://www.dyndns.com> or <http://www.no-ip.com>)

Network Setup - Guide to the Network Environment

Please configure the IP Camera at the installation site. You must determine your network scenario to configure the IP Camera with the proper TCP/IP settings. This tutorial will guide you through the process. Before actually configuring the IP Camera, determine settings to be applied. Record those settings to be used to configure your IP Camera for reference.

When configuring your IP Camera, treat the IP Camera as another PC on your network. You will assign it to several addresses and other TCP/IP properties to match your current network.

This step-by-step tutorial will teach what IP addresses and network configurations should be assigned based on the network scenario.

- 1 Before you begin, locate any information and settings received from your Internet Service Provider (ISP). You may need to refer to these IP addresses at a later time during the configuration.

Current TCP/IP Settings	
IP Address	
Subnet Mask	
Default Gateway	
Primary DNS Server	
Secondary DNS Server (Option)	

Static Dynamic

- i** If you were not given any IP addresses or the ISP was responsible for the setup and installation of your Internet connection, go to step 2.
- i** If you are not using a router on your network, your 'Current TCP/IP Settings' (from the previous section) and 'Assigned IP Addresses from My ISP' will be exactly the same.

- 2 You must determine whether the IP address is STATIC or DYNAMIC. Contact your ISP to get a STATIC IP address for the camera.
- 3 Configure your IP Camera's TCP/IP settings for network connectivity by selecting Setup from the main interface and selecting TCP/IP located on the left of the setup screen.

- 4 If prompted for ID and password, use 'admin' for both entries. The default web port number is 80. If port 80 is blocked by the ISP, use a value between 1025 - 60000. If TCP port 80 is blocked, contact your ISP.
- 5 The following descriptions are several basic network scenarios. Determine which scenario describes your network. If your network does not match one of the scenarios below and you are unsure how to setup your IP camera, contact your network administrator.

i You cannot control the rectangular gray areas and only the ISP has access to the devices.

Network Setup - Setup Case A, B

Case A: Dynamic IP + Personal Router [Most SOHO]

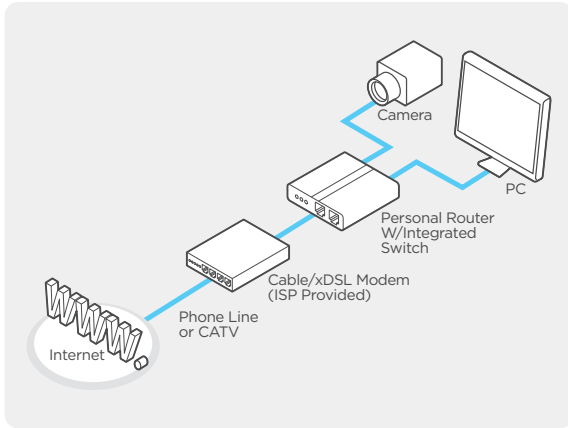

Case B: Static(Fixed) IP + Personal Router [Efficient]

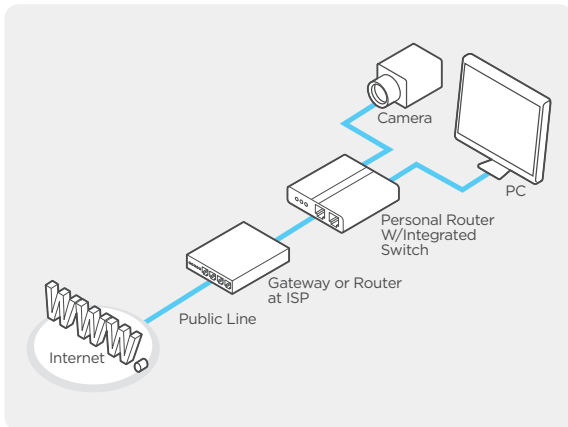

Configure your IP Camera's TCP/IP properties:

1 Network Type: STATIC (even though you have Dynamic IP from your ISP, use STATIC on the IP camera).

2 Internet Address: A private IP address such as 192.168.0.200 (example)

- i** You need to assign an IP address to the IP Camera just as you do with PC.
- i** The IP address you assign must be unique to your network and match your network as well. For information on how to choose a unique IP and match your network, read the FAQ.
- i** The IP address you assign must be a private IP. For information on how to choose a private IP please, read the FAQ.

3 Subnet Mask: 255.255.255.0 (example)

- i** You must use the same subnet mask as the one you noted under 'Current TCP/IP Settings'.

4 Default Gateway: 192.168.0.1 (example)

- i** This IP address must be the IP address of your router. (private or LAN side)
- i** Use the same Default Gateway you noted under 'Current TCP/IP Settings'.

5 Preferred DNS Server: Use the 1st DNS Server from 'Assigned IP Address from My ISP'.

- i** If you did not receive any IP addresses from your ISP, contact the ISP and acquire the IP address of their DNS server.

6 DDNS Server: Use the DDNS server.

- i** This is the same site you will register later to accommodate dynamic IP from your ISP.

7 Web Port: 8888

- i** Do not use the default port 80 as this number must be changed.
- i** Select a number between 1025 - 60000.

Network Setup - Setup Case C, D

Case C: Static(Fixed) IP [Dedicated line directly to the IP Camera]

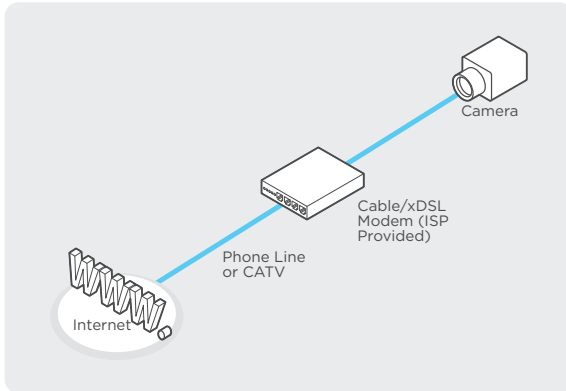

Configure your IP Camera's TCP/IP properties:

- 1 Network Type: STATIC
- 2 Internet Address: A static IP address received from your ISP such as 24.107.88.125 (example)

i You need to assign an IP address to the IP Camera just as you do with PC.

- 3 Subnet Mask: Subnet mask assigned from your ISP such as 255.255.255.240 (example)

- 4 Default Gateway: 24.107.88.113 (example)

i Use the assigned default gateway from your ISP.

- 5 Preferred DNS Server: Use the 1st DNS Server from 'Assigned IP Address from My ISP'

i If you have not received any IP addresses from your ISP, contact them to acquire the IP address of their DNS server.

- 6 DDNS Server: Use the DDNS server

i This is the same site you will register later to utilize our DDNS service.

- 7 Web Port: 80

i Select a number between 1025 - 60000.

Case D: Dynamic IP + DSL/Cable Modem [Connected directly to the IP Camera]

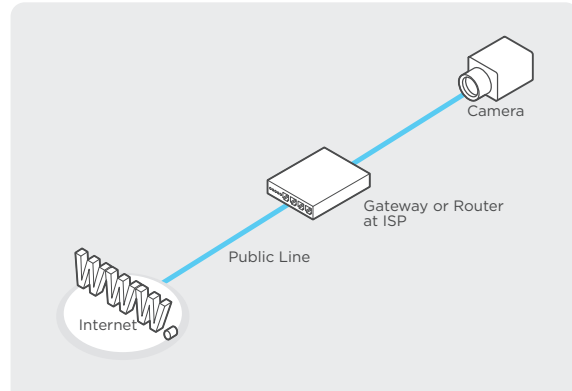

- i** To connect the IP Camera directly to a modem, power down and reset the modem. Leave the modem powered down until the IP camera's setup is completed and the IP camera has been connected to the modem. Then power on the modem, followed by the IP camera.

Configure your IP Camera's TCP/IP properties:

- 1 Network Type: DYNAMIC
- 2 DDNS Server: Use the DDNS server

i This is the same site you will register later to accommodate dynamic IP from your ISP.

- 3 Web Port: 80

i Select a number between 1025 - 60000.

Network Setup - Port Forwarding

After entering the correct TCP/IP settings, you are ready for 'Port Forwarding' (Cases A, B).

- 1 Please record the TCP/IP settings of your IP camera for future reference. You may need this information to access your IP Camera and to configure 'port forwarding'.

IP camera TCP/IP settings	
IP address	
Subnet mask	
Default gateway	
Preferred DNS server	
DDNS server	
Web port	

- 2 After clicking 'Apply', the system will prompt for a reboot. Please allow the system 50 seconds to reboot and accept the changes. After 50 seconds, close the configuration screen. The view will display 'Trying to Reconnect'.
If the ACTIVE light on the IP Camera has gone off and is now back on again flashing, the IP Camera has rebooted. After the system reboots completely, remove the power supply from the unit and close Internet Explorer.
- 3 Return your PC/Laptop TCP/IP properties to their original settings.
- 4 Before installing the IP camera, you must perform port forwarding on your router (Cases A, B).
You will need to forward 1 port:
 - Web Port: All the ports will be forwarded to the IP address you assigned to the IP Camera.
In the example above, you would forward:
 - 8888 > 192.168.0.200

Network Setup - Starting IP Camera

After forwarding correctly the Web Port, through your router (if applicable), install the IP Camera in a proper location.

- 1 Locate the serial number located on the label attached to the bottom of the IP camera, you will need this for DDNS registration.
- 2 Connect the IP Camera to your router or cable/DSL modem (per your network scenario) via a Cat5/5e UTP Ethernet network cable.
- 3 Supply power to the IP camera.
- 4 After 1 minute, verify the IP camera indicators:
 - LINK: Flickering/Solid
- 5 After configuring port forwarding on your computer (if necessary), access your IP camera on your local network by opening Internet Explorer and specifying the IP address and web port assigned to the IP camera.

i Examples: <http://192.168.0.200:8888> or <http://24.106.88.123>

i If you left your web port as 80, you do not need to specify the port in the address bar to access the IP camera.

- 6 Access your IP camera via the Internet :

If you use cases B, C:

1. Open Internet Explorer.
2. Type the address of the IP camera.
3. If you use a router, enter the routers' static IP and the web port number of the IP camera.

If you use cases A, sD:

1. Open Internet Explorer and go to your DDNS website.
2. Register the IP camera.
3. Reboot the IP camera.
4. Give the DDNS server 10 minutes to locate your IP camera's IP information.
5. Click the refresh button in Internet Explorer.
6. After your camera is connected, select your camera.

i The difference between B and C is that B needs to set the port forwarding.

i Since the type of DDNS differs from the service type, refer to the related service site.

Appendix

FAQ

1. My POWER light is not on?

Power is not being supplied to the unit. Please use the power supply shipped with the unit and verify that a power source is active from the attached power outlet used to connect the adapter. You can test this by plugging in any other electrical device and verify its operation. After using the power supply shipped with the product, check the power source, and reinserting the power connector into the IP Camera, please call our Support Center. The power supply may be defective.

2. My ACTIVE light is not flashing?

Verify the power supply to the unit. Power off the unit and back on again, wait 1 minute, if the ACTIVE light still does not begin to flash, you will have to set the unit to its factory default (THIS WILL DELETE ANY CONFIGURATION AND SET THE UNIT TO THE FACTORY DEFAULTS). Power on the unit and insert the end of a paper clip into the small recessed opening on the back of the unit. Use the clip to press the button located within that opening.

3. My LINK light is not flashing or solid?

Verify the cable connection. 99% of the time the cable's connection to the unit is causing this problem. Try using a different network cable or crossover cable (for PC connection only). Try reinserting the cable, if this still doesn't solve the problem call our Support Center.

4. I can access the video server on my LAN, but not from the Internet.

Verify that your router (if applicable) has port forwarding properly configured. If accessing from our DDNS service, verify the correct serial number. Firewall issues may prevent user access.

5. How do I open an MS-DOS or Command Prompt?

Start > (All) Programs > Accessories > Command Prompt

6. How do I find out my IP address information if my settings were automatically detected?

- 1) Open a Command Prompt
- 2) At the prompt type - "ipconfig / all" (without the quotes)
- 3) Near the end of the information supplied, should be your current IP address, subnet mask, default gateway and DNS servers

7. I can't connect!!

In the case of a connection failure.
Modem Reboot > Modem Reboot Finished > Router Reboot > Router Reboot Finished > IP Camera Reboot > IP Camera Reboot Finish > Verify DDNS and IP Camera connection, if applicable.

8. How do I "PING" an IP address?

- 1) Open an MS-DOS (or Command) prompt
- 2) At the prompt type - "ping xxx.xxx.xxx.xxx" (without the quotes and replace the "x" s with an IP address)
- 3) Press Enter

9. I'm accessing my video server remotely over the Internet and the video stream is choppy, is this normal?

Yes. The frames per second received remotely are determined by your bandwidth capabilities both at your site where the IP Camera is installed and your remote location. The lower of the two sites will determine how fast your video stream is received. It is recommended to have at least a 256Kb/sec upstream connection from the site where the IP Camera is installed. Lower speeds will operate properly but provide poor remote performance. The Faster the Internet connection at both ends, the faster the video stream.

10. How do I enable or check VLC on my browser

Internet Explorer

Open Internet Explorer > Tools on the menu bar > Internet Options > Security Tab > Custom Level > Scroll down and verify that you are prompted or have enabled plug-ins to be downloaded and executed. > click OK > restart browser.

Chrome

Open Chrome > Chrome menu settings > Advanced settings > Individual information - content settings > Run automatically

11. How do I reset the unit to factory defaults?

Refer to the previous functions page and find the reset button. Power ON the unit and use a paper clip to push the reset button within that opening. You should then see the ACTIVE light turn off and after a few seconds, the ACTIVE light will begin to flash, signifying a successful reboot. If the ACTIVE light does not turn off after depressing the reset button, please try holding the button in for a few seconds and releasing it. YOU WILL LOSE ALL DATA THAT HAD BEEN ENTERED PREVIOUSLY AND THE IP CAMERA WILL BE SET TO ITS FACTORY RESETS.

Specifications - Dimension

Unit: inches (mm)

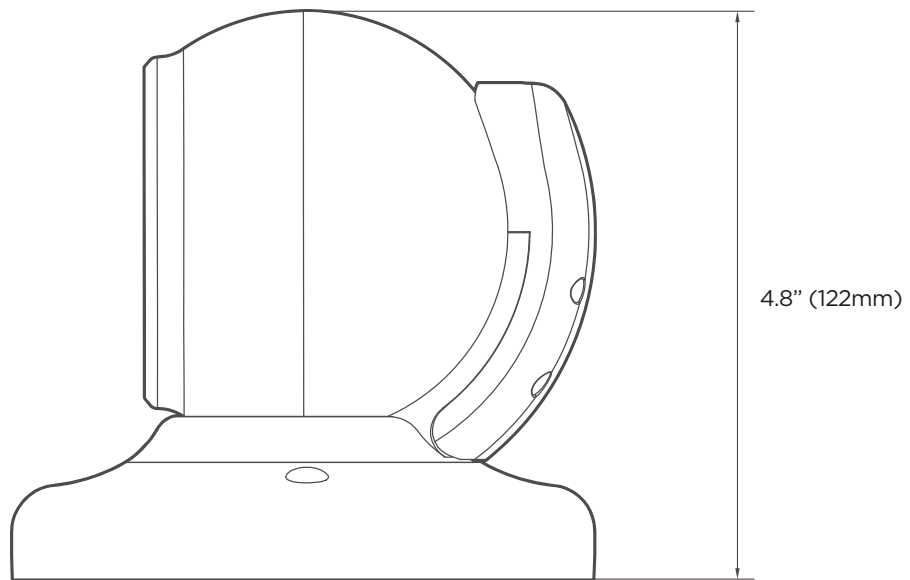
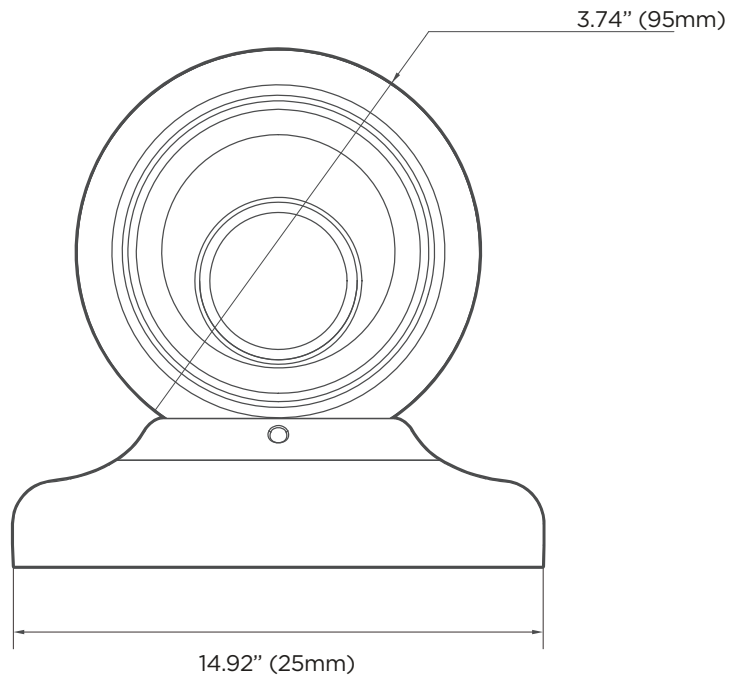

Specification

CAMERA	
Image sensor	1/2.8" 2.1MP/1080p CMOS
Total pixels	1945 (H) X 1109 (V)
Focal length	2.7 - 13.5mm, F1.8 / MFZ
Field Angle	D: 39.1° - 106.6°, H: 34.1° - 93.6° V: 19.2° - 51.8°
Shutter speed	Auto / manual (1/15 - 1/32000), anti-flicker, slow shutter (1/2 1/3 1/5 1/6 1/7.5 1/10)
MIN. illumination	0.043 lux (color), 0 lux with IR (F1.8)
IR	H2IR, 80ft
Zoom	X5 optical zoom
WDR	True WDR (DOL)
Day and night	TDN (true day and night)
DNR	3D-DNR
Privacy zone	16 programmable zone
AGC	Auto
Other image processing	Exposure, white balance, sharpness, BLC, brightness, contrast, saturation, hue

ENCODER (VIDEO AND AUDIO)	
Video compression	H.265, H.264, MJPEG
H.264 profile	MP/HP
H.265 profile	MP
Multiple profile streaming performance	1080p @30fps + D1(704x480 or 704x576) @30fps with H.264, H.265 + MJPEG
Video bitrate	100kbps-10Mbps, multi-rate for preview and recording
Bitrate control	Multistreaming CBR/VBR at H.264, H.265 (controllable frame rate and bandwidth)
Event Notification	FTP, E-Mail

SECURITY AND NETWORK	
Network protocol	IPv4: TCP/IP / UDP / AutoIP / RTP(UDP/TCP) / RTSP / NTP / HTTP / HTTPS / SSL / DNS / DDNS / DHCP / FTP / SMTP / ICMP / SNMPv1/v2/v3(MIB-2) / ONVIF
Security	HTTPS (SSL), IP filtering, 802.1x, Digest Authentication
Plug-in	CGI, API, ONVIF

GENERAL	
Support languages	English
Power	(Adaptor is not Included) DC12V: max 6.4W POE IEEE 802.3af class3: max 7.6W
Temperature	-4°F - 122°F (-20°C - 50°C)
Material	Aluminum die-casting
Dimensions(DXH)	4.92" x 4.8" (125 x 122 mm)
Weight	1.76lbs (0.8kg)
Certification	FCC, CE, ROHS, IP67, IK10

Warranty Information

Digital Watchdog (referred to as “the Warrantor”) warrants the Camera against defects in materials or workmanship as follows:

Labor: For the initial five (5) years from the date of the original purchase if the camera is determined to be defective, the Warrantor will repair or replace the unit with the new or refurbished product at its option, at no charge.

Parts: Also, the Warrantor will supply replacement parts for the initial two (2) years.

To obtain warranty or out of warranty service, please contact a technical support representative at:

1+ (866) 446-3595, Monday through Friday from 9:00 AM to 8:00 PM EST.

A purchase receipt or other proof of the date of the original purchase is required before warranty service is rendered. This warranty only covers failures due to defects in materials and workmanship which arise during normal use. This warranty does not cover damages which occurs in shipment or failures which are caused by products not supplied by the Warrantor or failures which result from accident, misuse, abuse, neglect, mishandling, misapplication, alteration, modification, faulty installation, setup adjustments, improper antenna, inadequate signal pickup, maladjustments of consumer controls, improper operation, power line surge, improper voltage supply, lightning damage, rental use of the product or service by anyone other than an authorized repair facility or damage that is attributable to acts of God.

Limits and Exclusions

There are no express warranties except as listed above. The Warrantor will not be liable for incidental or consequential damages (including without limitation, damage to recording media) resulting from the use of these products, or arising out of any breach of the warranty. All express and implied warranties, including the warranties of merchantability and fitness for a particular purpose, are limited to the applicable warranty period set forth above.

Some states do not allow the exclusion or limitation of incidental or consequential damages or limitations on how long an implied warranty lasts, so the above exclusions or limitations may not apply to you. This warranty gives you specific legal rights, and you may also have other rights from vary from state to state.

If the problem is not handled to your satisfaction, then write to the following address:

Digital Watchdog, Inc.
ATTN: RMA Department
16220 Bloomfield Ave
Cerritos, CA 90703

Service calls which do not involve defective materials or workmanship as determined by the Warrantor, in its sole discretion, are not covered. Cost of such service calls are the responsibility of the purchaser.



Complete Surveillance Solutions

DW® East Coast office and warehouse: 5436 W Crenshaw St, Tampa, FL USA 33634
DW® West Coast office and warehouse: 16220 Bloomfield Ave, Cerritos, CA USA 90703

PH: 866-446-3595 | FAX: 813-888-9262

www.Digital-Watchdog.com

technicalsupport@dwcc.tv

Technical Support PH:

USA & Canada 1+ 866-446-3595

International 1+ 813-888-9555

French Canadian: 1+ 514-360-1309

Technical Support hours: Monday-Friday 9 a.m. to 8 p.m. Eastern Time