

Owner's Manual

NetDirector® 8/16-Port 1U Rack-Mount HDMI/USB KVM Switch with Audio and Peripheral Sharing

Models: B024-HU08, B024-HU16

WARRANTY REGISTRATION

Register your product today and be automatically entered to win an ISOBAR surge protector in our monthly drawing!

tripplite.com/warranty



1111 W. 35th Street, Chicago, IL 60609 USA • tripplite.com/support

Copyright © 2019 Tripp Lite. All rights reserved.

Table of Contents

| | | | |
|--|-----------|---|-----------|
| 1. Product Features | 3 | 11. Hot Key Operation | 30 |
| 2. Package Includes | 3 | 11.1 Hot Key Commands | 30 |
| 3. Safety Instructions | 4 | 11.2 Hot Key Setting Mode | 30 |
| 4. System Requirements | 5 | 11.2.1 Invoking HSM | 30 |
| 4.1 Console | 5 | 11.3 Select the Active Port | 30 |
| 4.2 Computers | 5 | 11.4 Auto Scan Mode | 31 |
| 4.3 Supported Operating Systems | 5 | 11.4.1 Invoking Auto Scan | 31 |
| 5. Introduction | 6 | 11.5 Skip Mode | 31 |
| 5.1 Front Panel | 6 | 11.6 Keyboard/Mouse Reset | 32 |
| 5.2 Rear Panel | 7 | 11.7 Hot Key Beeper Control | 32 |
| 6. Rack-Mount Installation | 8 | 11.8 Quick Hot Key Control | 32 |
| 6.1 Rack Mounting – Front | 8 | 11.9 OSD Hot Key Control | 32 |
| 6.2 Rack Mounting – Rear | 10 | 11.10 Port OS Control | 32 |
| 7. Installation | 12 | 11.11 Restore Default Values | 33 |
| 7.1 Single-Level Installation | 12 | 11.11.1 USB Reset | 33 |
| 7.2 Cascading | 14 | 11.11.2 Hot Key Beeper Control | 33 |
| 7.2.1 Two-Level Installation | 14 | 11.11.3 Mouse Emulation Control | 33 |
| 7.2.2 Three-Level Installation | 16 | 11.12 HSM Summary Table | 34 |
| 8. Multi-Display Installation | 18 | 12. Keyboard Emulation | 35 |
| 8.1 Cable Connections for Multi-Display Installation | 18 | 12.1 Mac Keyboard | 35 |
| 8.2 Grouping Ports into “Vertical” Channels | 20 | 12.2 Sun Keyboard | 36 |
| 9. Operation | 21 | 13. Firmware Management Utility | 37 |
| 9.1 Hot Plugging | 21 | 13.1 Introduction | 37 |
| 9.1.1 Hot Plugging KVM Ports | 21 | 13.1.1 Downloading the Firmware Upgrade Package | 37 |
| 9.1.2 Hot Plugging Console Ports | 21 | 13.2 Preparation | 37 |
| 9.2 Port Selection | 21 | 13.3 Starting the Upgrade | 38 |
| 9.2.1 Manual Port Switching | 21 | 13.4 Upgrade Succeeded | 39 |
| 9.3 Port ID Numbering | 21 | 13.5 Upgrade Failed | 39 |
| 9.4 Powering Off and Restarting | 21 | 13.6 Firmware Upgrade Recovery | 40 |
| 10. On-Screen Display (OSD) Operation | 22 | 13.7 OSD Configuration Backup/Restore | 40 |
| 10.1 OSD Overview | 22 | 13.7.1 Backup | 40 |
| 10.1.1 Manufacturing Number | 22 | 13.7.2 Restore | 41 |
| 10.1.2 OSD Login | 22 | 14. Appendix | 42 |
| 10.1.3 OSD Hot Key | 22 | 14.1 Factory Default Hot Keys and Settings | 42 |
| 10.1.4 OSD Main Screen | 22 | 14.2 Specifications | 42 |
| 10.1.5 OSD Main Screen Headings | 23 | 15. Warranty & Product Registration | 43 |
| 10.1.6 Navigation | 23 | | |
| 10.2 OSD Functions | 23 | | |
| 10.2.1 F1: GOTO | 23 | | |
| 10.2.2 F2: LIST | 24 | | |
| 10.2.3 F3: SET | 25 | | |
| 10.2.4 F4: ADM | 26 | | |
| 10.2.5 F5: SKP | 28 | | |
| 10.2.6 F6: BRC | 28 | | |
| 10.2.7 F7: SCAN | 28 | | |
| 10.2.8 F8: LOUT | 29 | | |

1. Product Features

- Control up to eight (B024-HU08) or 16 (B024-HU16) HDMI computers and two USB 2.0 peripheral devices using one centralized monitor, keyboard and mouse.
- Cascade up to three levels with the B024-HU08 (control up to 512 computers) or two levels with the B024-HU16 (control up to 256 computers).
- Effortlessly switch between computers using either the front panel buttons, hot keys or on-screen display (OSD).
- The KVM and USB focus can be switched independently of one another; for example, you can access one computer while simultaneously printing from another computer.
- Support HDMI video resolutions up to 1920 x 1200 @ 60 Hz.
- Console mouse emulation supports multi-functional mice and most mouse drivers.
- OSD Backup/Restore feature allows the administrator to back up the switch's configurations and user profile information.

2. Package Includes

- B024-HU08 or B024-HU16
- HDMI/USB Custom KVM Cable Kits (x2) – 6 ft.*
- Firmware Upgrade Cable – 6 ft.
- External Power Supply with C13 to NEMA 5-15P Power Cord (Input: 100-240V, 50/60 Hz, 0.7A; Output: 5V 4A)
- Rubber Feet (x4)
- Mounting Hardware
- Quick Start Guide

* Note: The microphone connector on the cable kit will not be used because the B024-HUXX supports speakers only.

Optional Accessories

- P569-Series High Speed HDMI Cables
- UR022-Series USB 2.0 Reversible A/B Cables
- P312-Series 3.5mm Mini Stereo Audio Cables
- P782-0XX-HA HDMI/USB/Audio Custom KVM Cable Kits*

* P130-000 HDMI to DVI adapter sold separately.

3. Safety Instructions



- Read all instructions and save for future reference.
- Follow all warnings and instructions marked on the device.
- Do not place the device on any unstable surface (cart, stand, table, etc.); if the device falls, serious damage will result.
- Do not use the device near water.
- Do not place the device near or over radiators or heat registers. The device cabinet's slots and openings allow for adequate ventilation. To ensure reliable operation and to protect against overheating, these openings must never be blocked or covered.
- The device should never be placed on a soft surface (bed, sofa, rug, etc.), as this will block its ventilation openings. The device should also not be placed in a built-in enclosure, unless adequate ventilation is provided.
- Never spill liquid of any kind onto the device.
- Unplug the device from the wall outlet before cleaning. Do not use liquid or aerosol cleaners. Always use a damp cloth for cleaning.
- The device should operate from the power source type as indicated on the marking label. If unsure what power type is available, consult your dealer or local power company.
- Do not allow anything to rest on the power cord or cables. Route power cord and cables so they cannot be stepped on or tripped over.
- If an extension cord is used with this device, make sure the total ampere ratings of all products used on this cord does not exceed the extension cord ampere rating. Make sure the total of all products plugged into the wall outlet does not exceed 15 amperes.
- To help protect your system from sudden transient increases and decreases in electrical power, plugging your devices into a Tripp Lite surge protector, line conditioner, or uninterruptible power supply (UPS) is recommended.
- When connecting or disconnecting power to hot-pluggable power supplies, observe the following guidelines:
 - Install the power supply before connecting the power cable to the power supply.
 - Unplug the power cable before removing the power supply.
 - If the system has multiple sources of power, disconnect power from the system by unplugging all power cables from the power supplies.
- Never push objects of any kind into or through cabinet slots. They may touch dangerous voltage points or short out parts resulting in a risk of fire or electrical shock.
- Do not attempt to service the device. Refer all servicing to qualified service personnel.
- If the following conditions occur, unplug the device from the wall outlet and bring it to qualified service personnel for repair.
 - The power cord or plug has become damaged or frayed.
 - Liquid has been spilled into the device.
 - The device has been exposed to rain or water.
 - The device has been dropped, or the cabinet has been damaged.
 - The device exhibits a distinct change in performance, indicating a need for service.
 - The device does not operate normally when the operating instructions are followed.
- Only adjust controls covered in the operating instructions. Improper adjustment of other controls may result in damage that will require extensive work by a qualified technician to repair.
- Do not connect the RJ11 port on the KVM marked UPGRADE to a public telecommunications network.
- The device is designed for IT power distribution systems with 120V phase-to-phase voltage.
- To prevent damage to your installation, it is important that all devices are properly grounded.

4. System Requirements

4.1 Console

- HDMI-compliant monitor
- USB Mouse/Keyboard
- Speakers (Optional)

4.2 Computers

- Source with an HDMI port
- USB Type-A port
- Speaker ports (Optional)

4.3 Supported Operating Systems:

| Operating System | | Version |
|------------------|---------|----------------------|
| Windows | | 2000 and higher |
| Mac | | OS 9.0 and higher |
| Linux | Kernal | 2.6 and higher |
| | RedHat | 9.0 and higher |
| | SuSE | 10 / 11.1 and higher |
| | Debian | 3.1 / 4.0 |
| | Ubuntu | 7.04 / 7.10 |
| UNIX | AIX | 4.3 and higher |
| | FreeBSD | 5.5 and higher |
| | Sun | Solaris 8 and higher |
| Novell | Netware | 6.0 and higher |

5. Introduction

5.1 Front Panel

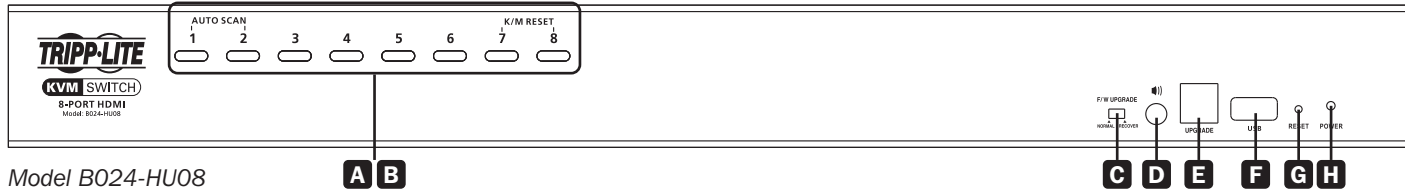

Model B024-HU08

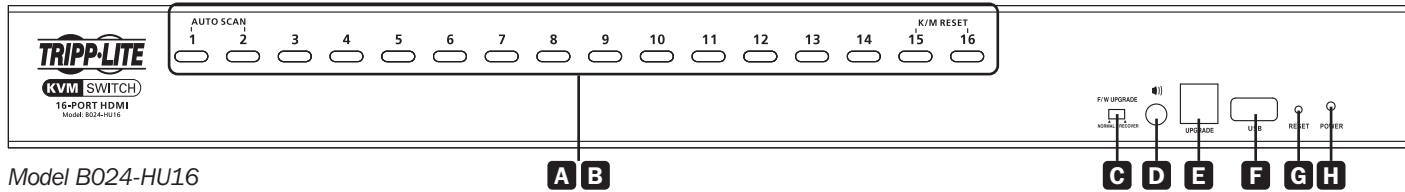

Model B024-HU16

| Key | Component | Description |
|-----|----------------------------------|---|
| A | Port Selection Pushbuttons | <p>For manual port selection (for details, see section 9.2 Port Selection):</p> <ul style="list-style-type: none"> Press a port selection pushbutton for less than two seconds to bring the KVM, USB hub, and audio focus to the computer attached to its corresponding port. Press a pushbutton for longer than two seconds to bring the KVM and audio selection to the computer attached to its corresponding port. Press pushbuttons 1 and 2 simultaneously for 2 seconds to start Auto Scan Mode (for details, see section 11.4 Auto Scan Mode). Press pushbuttons 7 and 8 simultaneously for 2 seconds to perform a keyboard and mouse reset (for details, see section 11.6 Keyboard/Mouse Reset). For independent switching, enable mouse emulation (see section 11.11.3 Mouse Emulation Control). |
| B | Port LEDs | <p>The Port LEDs are built into the Port Selection Switches. The KVM Port LEDs are on the left. The USB LEDs are on the right.</p> <p>KVM</p> <ul style="list-style-type: none"> Illuminates dim orange to indicate the computer attached to the corresponding port is up and running (On Line). Flashes to indicate Firmware Upgrade mode is in effect. Illuminates bright orange to indicate the computer connected to the corresponding port has the KVM focus (Selected). Flashes to indicate the computer connected to the corresponding port is being accessed under Auto Scan mode. <p>USB</p> <ul style="list-style-type: none"> Lights green to indicate the computer connected to the corresponding port is the one with access to the USB peripherals. |
| C | Firmware Upgrade Recovery Switch | <p>During normal operation and while performing a firmware upgrade, the switch should be in the NORMAL position. If a firmware upgrade operation does not complete successfully, this switch is used to perform a firmware upgrade recovery (for details, see section 13.6 Firmware Upgrade Recovery).</p> |
| D | Audio Port | <p>Connect speakers to this port (optional). The speakers plugged into this connector have priority over those plugged into the rear panel.</p> |
| E | Firmware Upgrade Port | <p>This port is used to upgrade the firmware on the KVM switch. Connect the included Firmware Upgrade Cable to this port.</p> |
| F | USB 2.0 Hub | <p>USB 2.0 peripherals (printers, scanners, etc.) can be connected to the port (a user-supplied power adapter may be required).</p> <p>Note: The USB 2.0 hub cannot be accessed through the switch by computers on the second or third level or a cascaded installation.</p> |
| G | Reset Switch | <p>Pressing this switch performs a system reset. When the system is reset, the unit beeps and the port LEDs flash in succession until the reset is complete. After the reset is complete, you can log in again.</p> |
| H | Power LED | <p>Illuminates to indicate the switch is powered and ready to operate.</p> |

5. Introduction

5.2 Rear Panel (Model B024-HU08 shown)

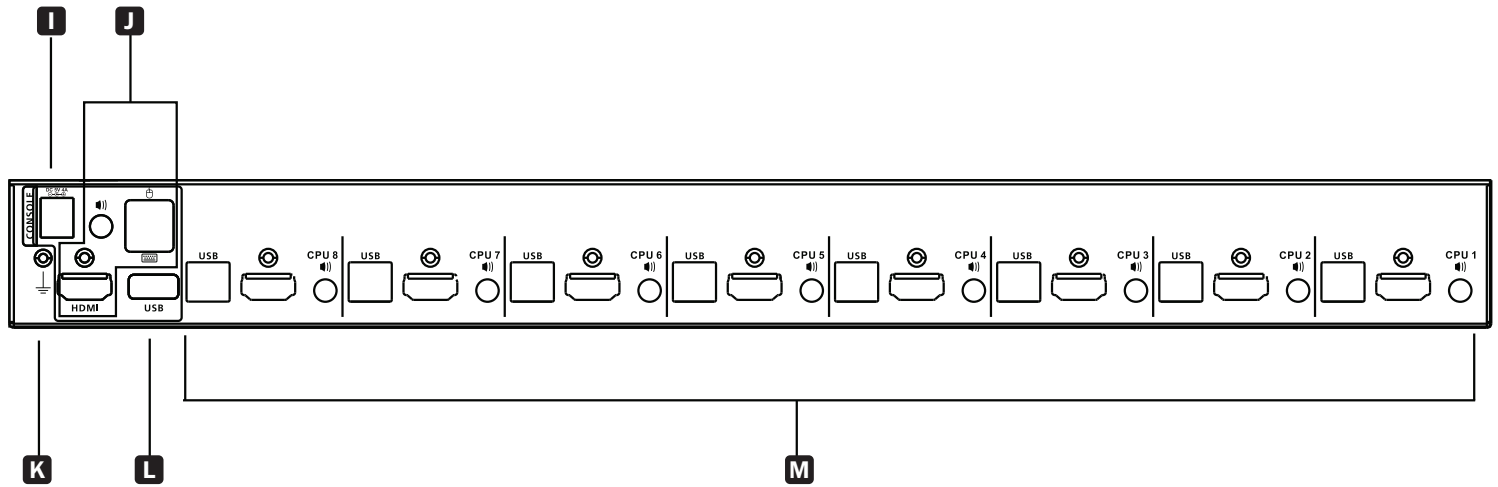

| Key | Component | Description |
|-----|------------------------|--|
| I | Power Jack | The power adapter cable connects here. |
| J | Console Port Selection | The cables from the console HDMI monitor, USB keyboard, USB mouse and speakers connect here. Each connector is marked with an appropriate icon to indicate the connector type. |
| K | Grounding Terminal | Connect a grounding wire to ground the switch (optional). |
| L | USB 2.0 Hub | USB 2.0 peripherals (printers, scanners, etc.) can be connected to the port. Note: The USB 2.0 hub cannot be accessed through the switch by computers on the second or third level of a cascaded installation. |
| M | KVM Port Selection | Cables that link the switch to the computers connect here. Each KVM port selection includes a speaker jack, a USB Type-B connector and an HDMI connector with screw lock. |

6. Rack-Mount Installation

6.1 Rack Mounting – Front

1. Remove screws, one each from the left and right sides near the front of the switch.

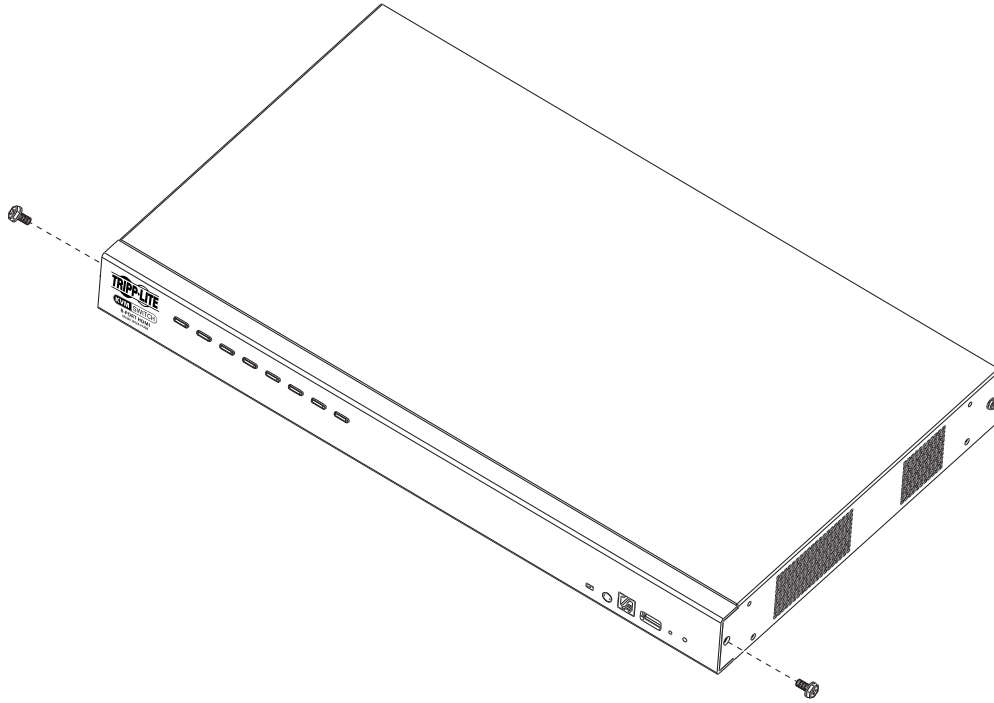

2. Use the M3 x 8 Phillips hex head screws supplied with the rack mounting kit to screw the rack mounting brackets into the sides near the front of the unit.

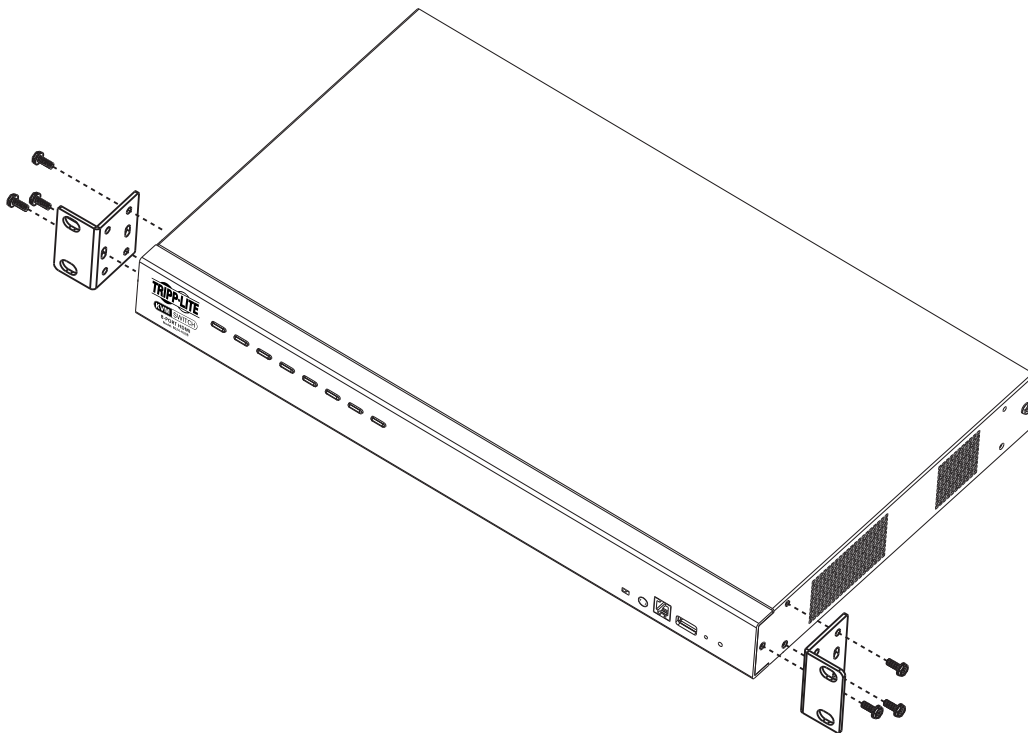

6. Rack-Mount Installation

3. Place the KVM switch in the rack. Position it so that the holes in the mounting brackets line up with the holes in the rack. Secure the mounting brackets to the front of the rack.

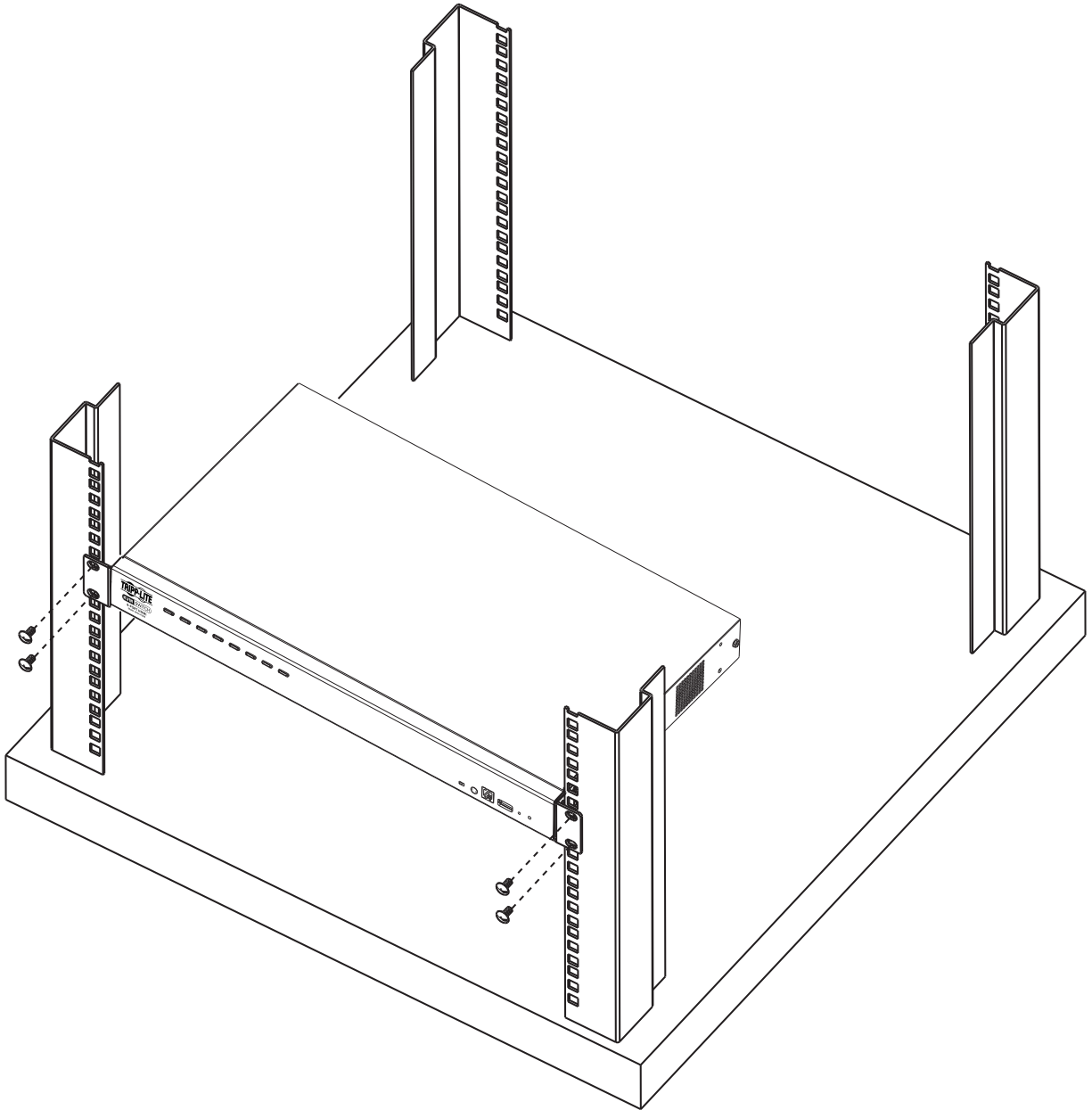

6. Rack-Mount Installation

6.2 Rack Mounting - Rear

1. Remove the screws, one each from the left and right sides near the rear of the switch.

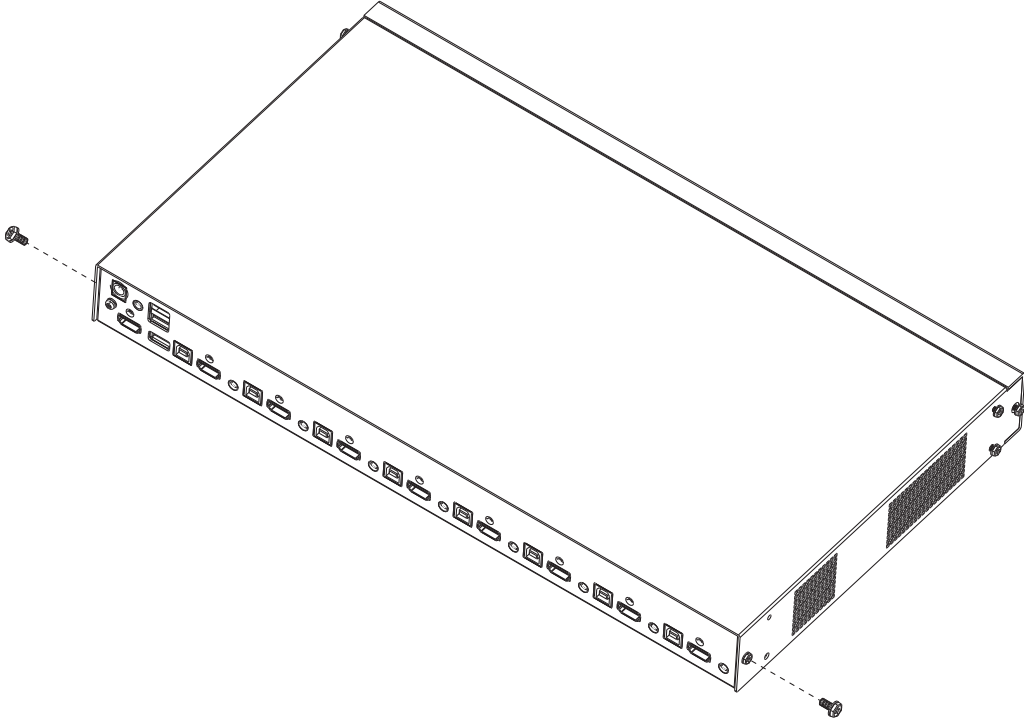

2. Use the M3 x 8 Phillips hex head screws supplied with the rack-mounting kit to screw the brackets into the sides near the rear of the unit.

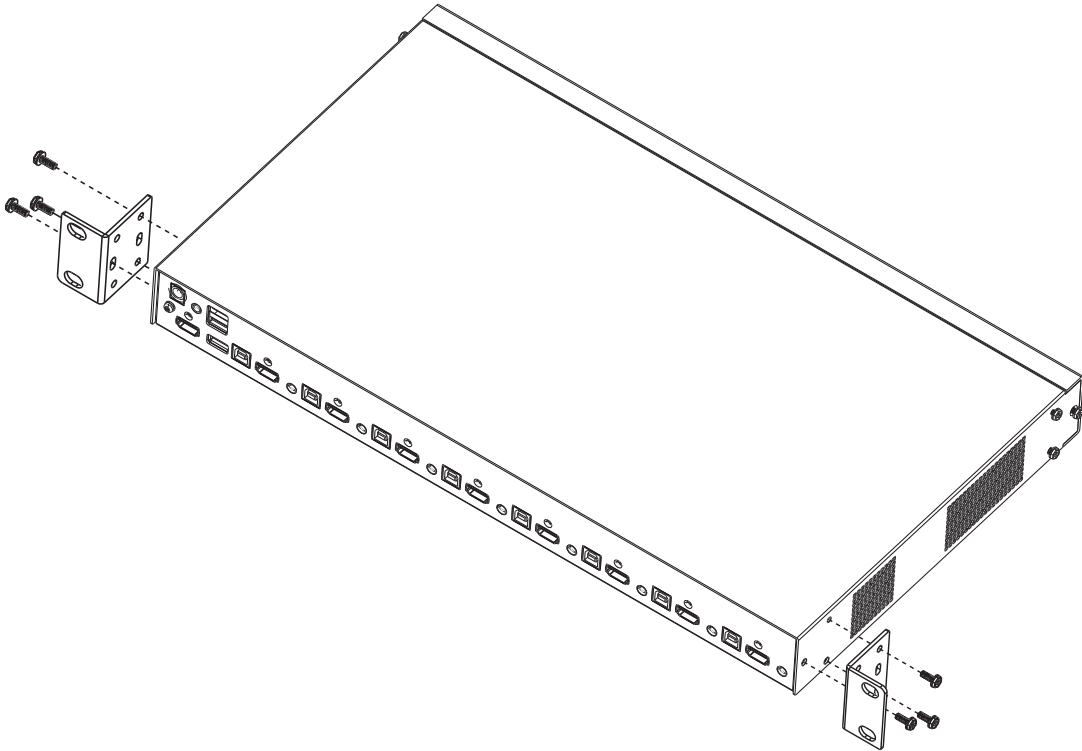

6. Rack-Mount Installation

- Place the KVM switch in the rack. Position it so the holes in the mounting brackets line up with the holes in the rack. Secure the mounting brackets to the rear of the rack.

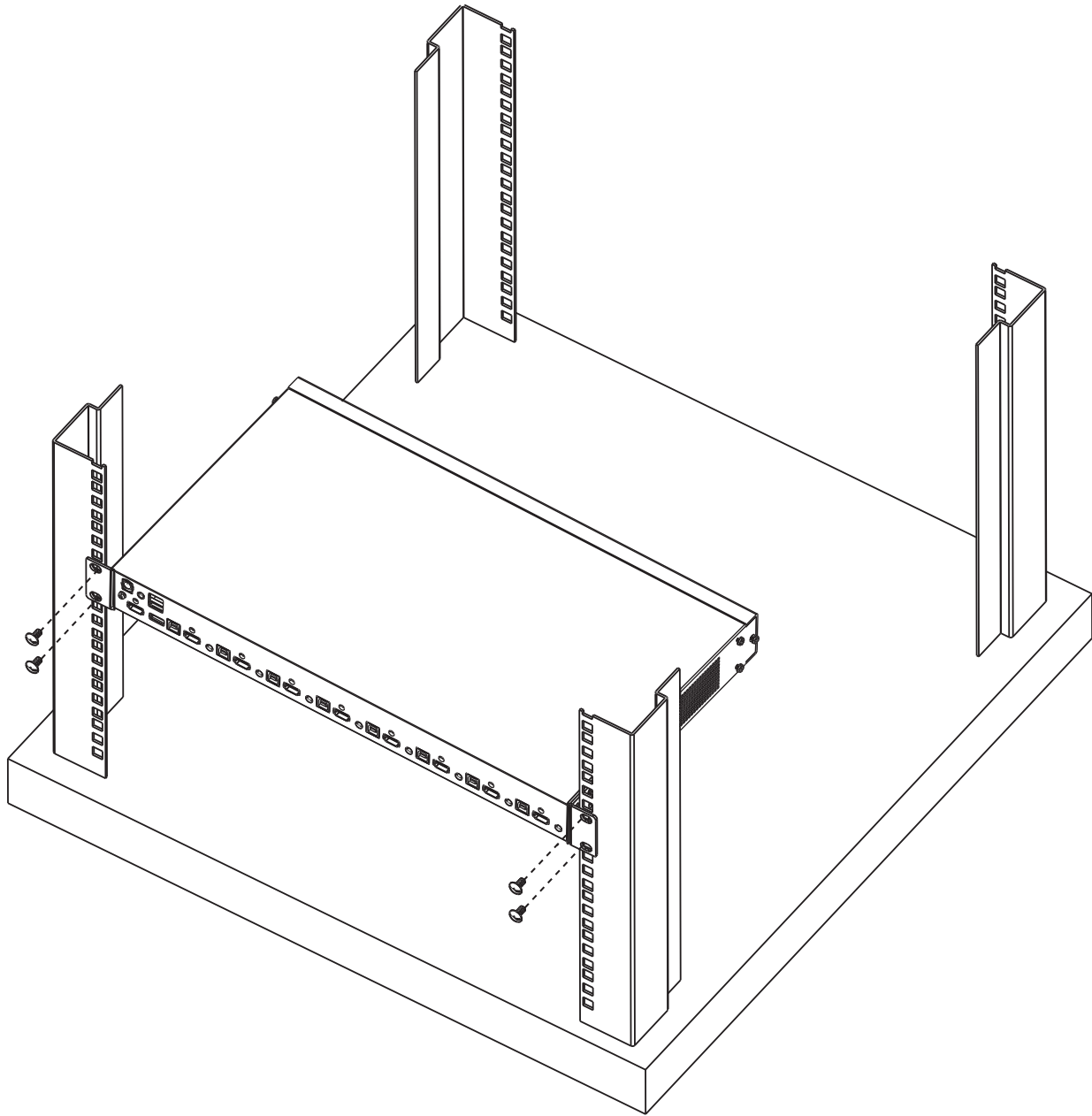

Note – Before beginning installation:

- Make sure power to all devices that you will be connecting has been turned off
- Properly ground the KVM switch to prevent damage to your installation from surges or static electricity

7. Installation

7.1 Single-Level Installation

To set up single-level installation, refer to the installation diagram on the following page (the numbers in the diagram correspond to the steps below) and perform the following:

1. Plug a USB keyboard and a USB mouse in the USB console ports located on the unit's rear panel.
2. Connect an HDMI monitor into the HDMI console port and power it on.
3. Plug primary speakers into the speaker jack located on the unit's front panel. Speakers plugged into the rear panel will be secondary to these speakers.
4. Plug secondary speakers into the audio port located on the unit's rear panel (optional).
5. Using Tripp Lite's P782-OXX-HA HDMI/USB/Audio KVM cable kit or individual HDMI, USB and audio cables, plug the HDMI connector into any available HDMI port, then plug in the accompanying USB and audio cables to their corresponding ports.
6. At the other end of the cable, plug the USB, video and speaker cables into their respective ports on the computer.
7. Plug USB peripherals into the Type-A connectors in the USB hub section.
8. Plug the power adapter that came with the switch into an AC power source, then plug the power adapter cable into the switch's power jack.
9. Power on connected computers.

7. Installation

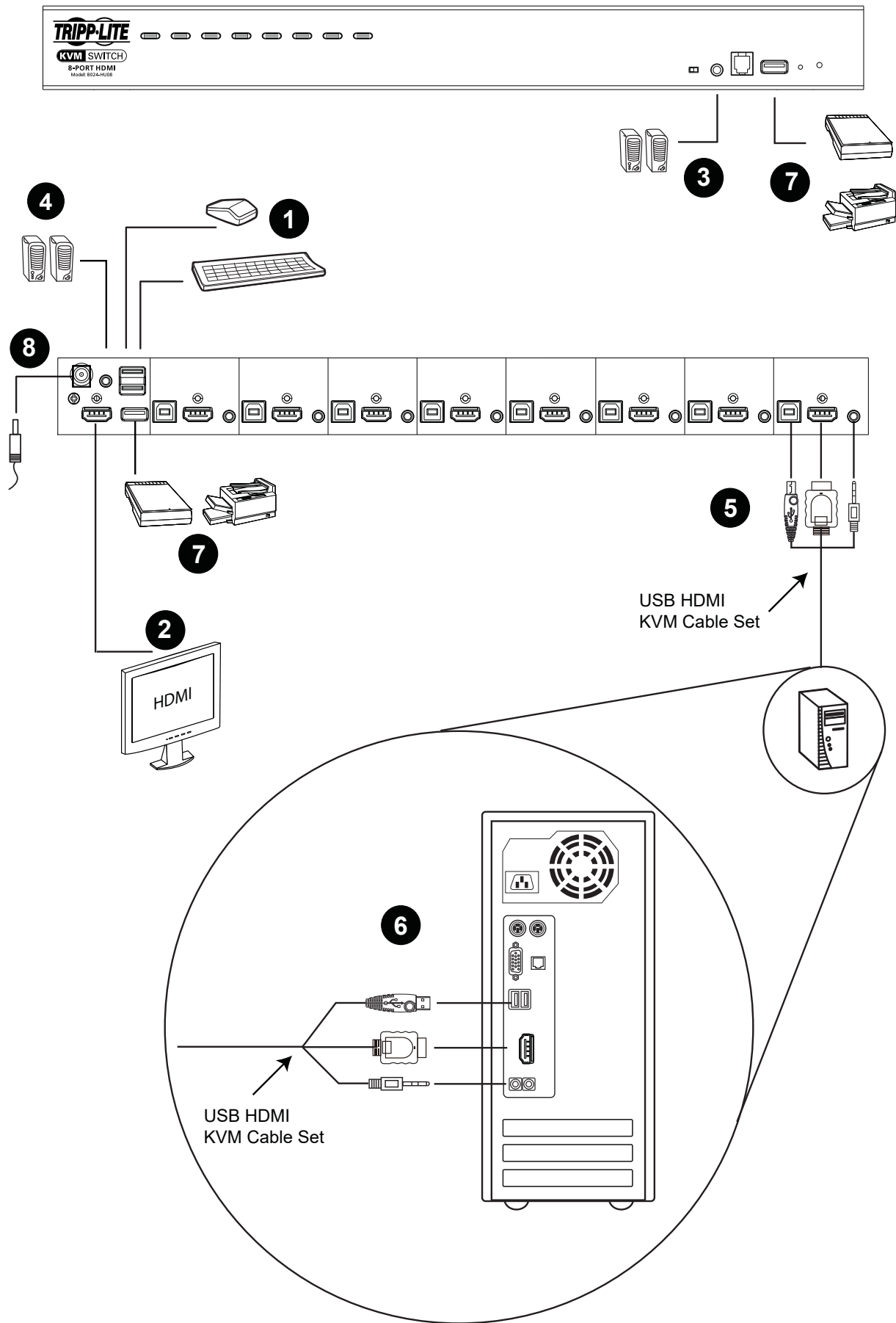

7. Installation

7.2 Cascading

7.2.1 Two-Level Installation

To control even more computers, additional B024-HU08 or B024-HU16 units can be cascaded from the KVM ports of the first-level unit. The cascaded B024-HUXX KVMs that connect back to the first-level unit are considered second-level units. As many as 64 (B024-HU08) or 256 (B024-HU16) computers can be controlled in a complete two-level installation.

To set up two-level installation, refer to the following Two-Level Installation diagram (the numbers in the diagram correspond to the steps below) and perform the following:

1. Make sure power to all the devices you will be connecting, including all previously installed devices, has been turned off.
2. Using Tripp Lite's P782-0XX-HA HDMI/USB/Audio KVM cable kit or individual HDMI, USB and audio cables, connect any available KVM port on the first-level unit to the console port of the second-level unit.
Note: Plug the USB Type-A connector into the lower USB (keyboard) port in the Console section. Connectors are marked with icons to indicate the correct USB port.
3. Using another Tripp Lite P782-0XX-HA HDMI/USB/Audio KVM cable kit or individual HDMI, USB and audio cables, plug the HDMI connector into any available HDMI port on the second-level unit, then connect the accompanying USB and audio cables to their corresponding ports.
4. At the other end of the cable, plug the USB Type-A, video and speaker cables into their respective ports on the computer.
5. Repeat steps 3 and 4 for any other computers you are connecting.
6. For each second-level unit, plug the power adapter cable into its power jack, then plug the power adapter into an AC source.
7. Plug the first-level unit's power adapter cable into its power jack, then plug the power adapter into an AC source.
8. Power on connected computers.

Notes:

- The power-on sequence requires that all second-level units be powered on first. After all are on, the first-level units must be powered on next. Only after all switches have been powered on in this sequence, can the computers be powered on.
- The USB 2.0 hub cannot be accessed through the switch by computers on the second or third level of a cascaded installation.

7. Installation

Two-Level Installation Diagram

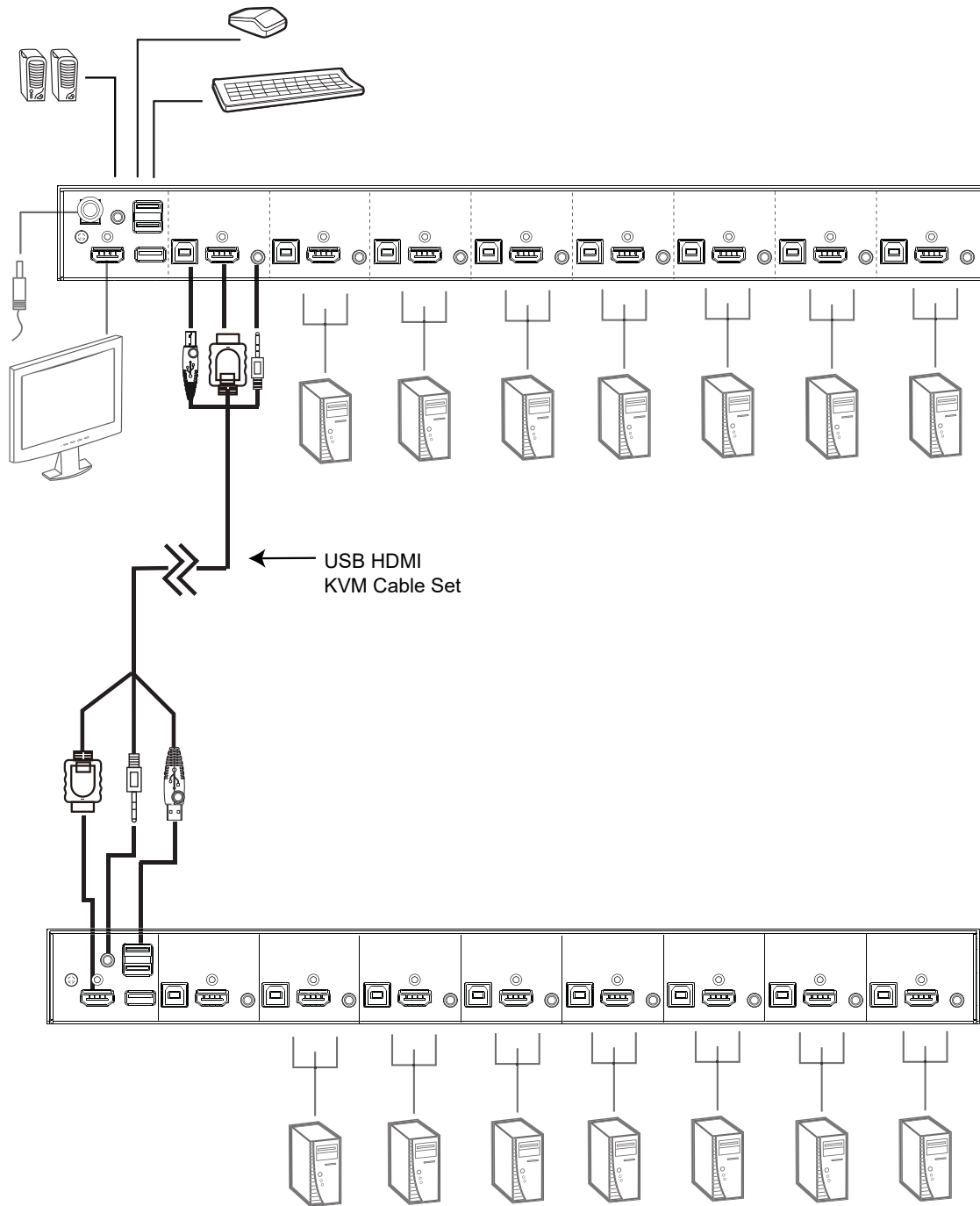

7. Installation

7.2.2 Three-Level Installation – B024-HU08 Only

The procedures for setting up a three-level installation are the same as for a two-level installation. Using the B024-HU08 in a three-level setup, as many as 512 computers can be controlled.

Notes:

- *The B024-HU08 cannot be cascaded beyond the third level and the B024-HU16 cannot be cascaded beyond the second level.*
- *The B024-HU08 can only be cascaded with other B024-HU08 units.*

Once all cables have been connected (**refer to section 7.2.1 Two-Level Installation**) to the third-level KVMs, power up devices according to the following sequence:

1. For each third-level unit, plug the power adapter cable into the switch's power jack. Plug the power adapter into an AC source.
2. For each second-level unit, plug the power adapter cable into the switch's power jack. Plug the power adapter into an AC source.
3. Plug the first-level unit's power adapter into its power jack. Plug the power adapter into an AC source.
4. Power on all computers.

7. Installation

Three-Level Installation Diagram

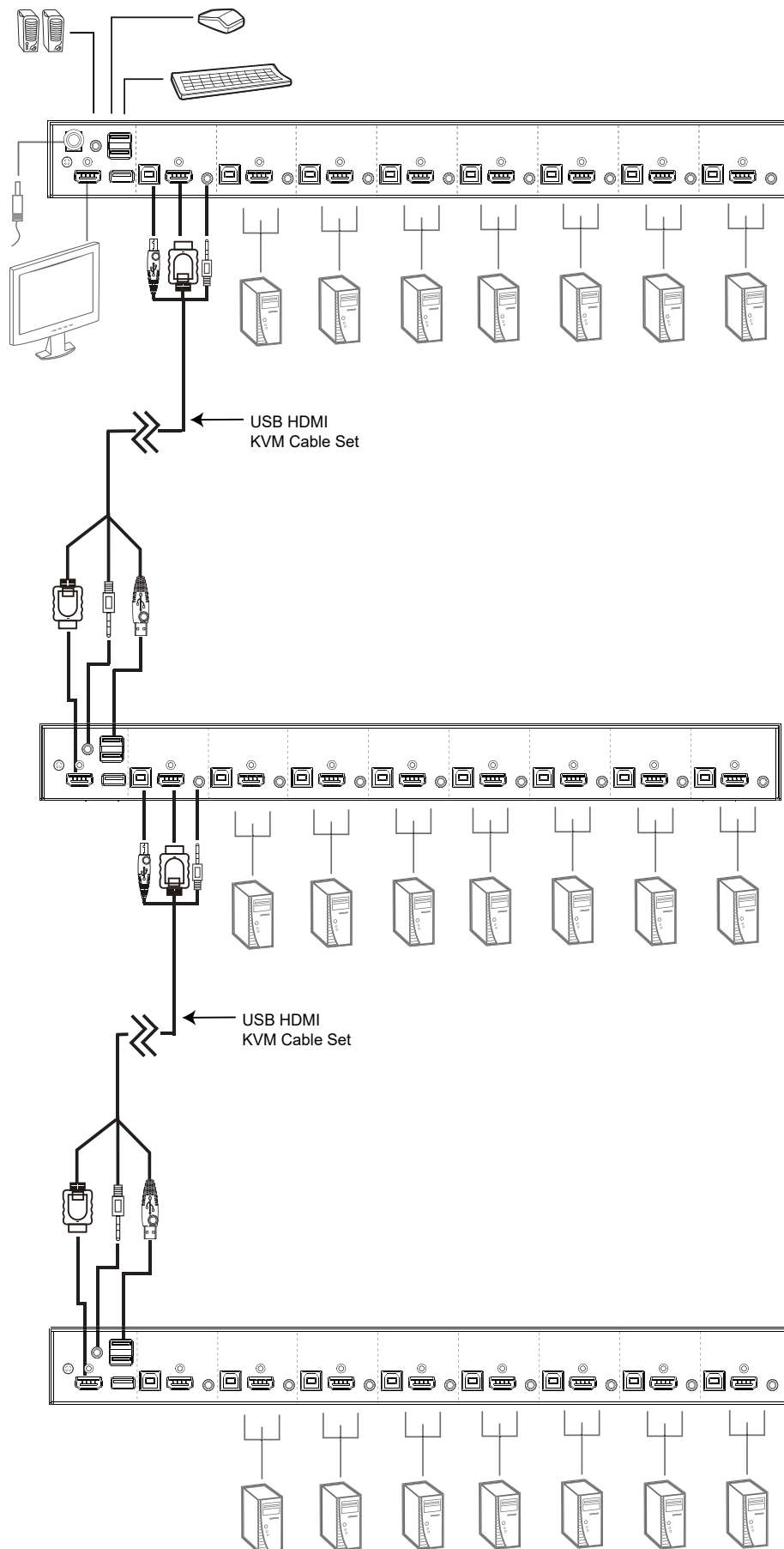

8. Multi-Display Installation

The B024-HU08 / B024-HU16 include a multi-display feature to support two, three, four or up to eight units in a dual/triple/quad-display/multi-display installation to control up to seven (B024-HU08) or fifteen (B024-HU16) computers at once. This installation requires slightly different cabling than the standard cascade and offers an extra level of switching flexibility for multiple-monitor installations where each computer is fitted with multiple video cards.

Note: In a Multi-display installation, the B024-HU08 can only be connected to B024-HU08 units, and the B024-HU16 can only be connected to B024-HU16 units.

8.1 Cable Connections for Multi-Display Installation

To set up a multi-display installation, refer to the following installation diagram (the numbers in the diagram correspond to the steps below) and perform the following steps:

1. Use a standard USB Type-A to USB Type-B cable to connect the Port 8 USB port on the first-stage unit to the USB port in the Console section of the second switch.
Note: Port 8 is reserved to connect the units in a multi-display installation, so up to seven (B024-HU08) or fifteen (B024-HU16) computers can be attached, using KVM ports 1–7 (B024-HU08) or ports 1–7/9–16 (B024-HU16).
2. Use HDMI cables to connect the HDMI KVM port on the second B024-HU08 / B024-HU16 unit to the second video-in port on the computer.
Note: Only HDMI video cables are necessary – the other ports in the KVM section are not required in this installation.
3. Connect a display to the console section of the second switch.
4. Repeat steps 1-3 for any additional units, up to eight switches.
5. Connect the cables for the first switch. See section **7.1 Single-Level Installation** for full details. All video, audio and peripheral devices must be connected to the first switch.
6. Power up the B024-HU08 / B024-HU16 units starting with the first switch, then power on the computers.

8. Multi-Display Installation

Multi-Display Installation Diagram

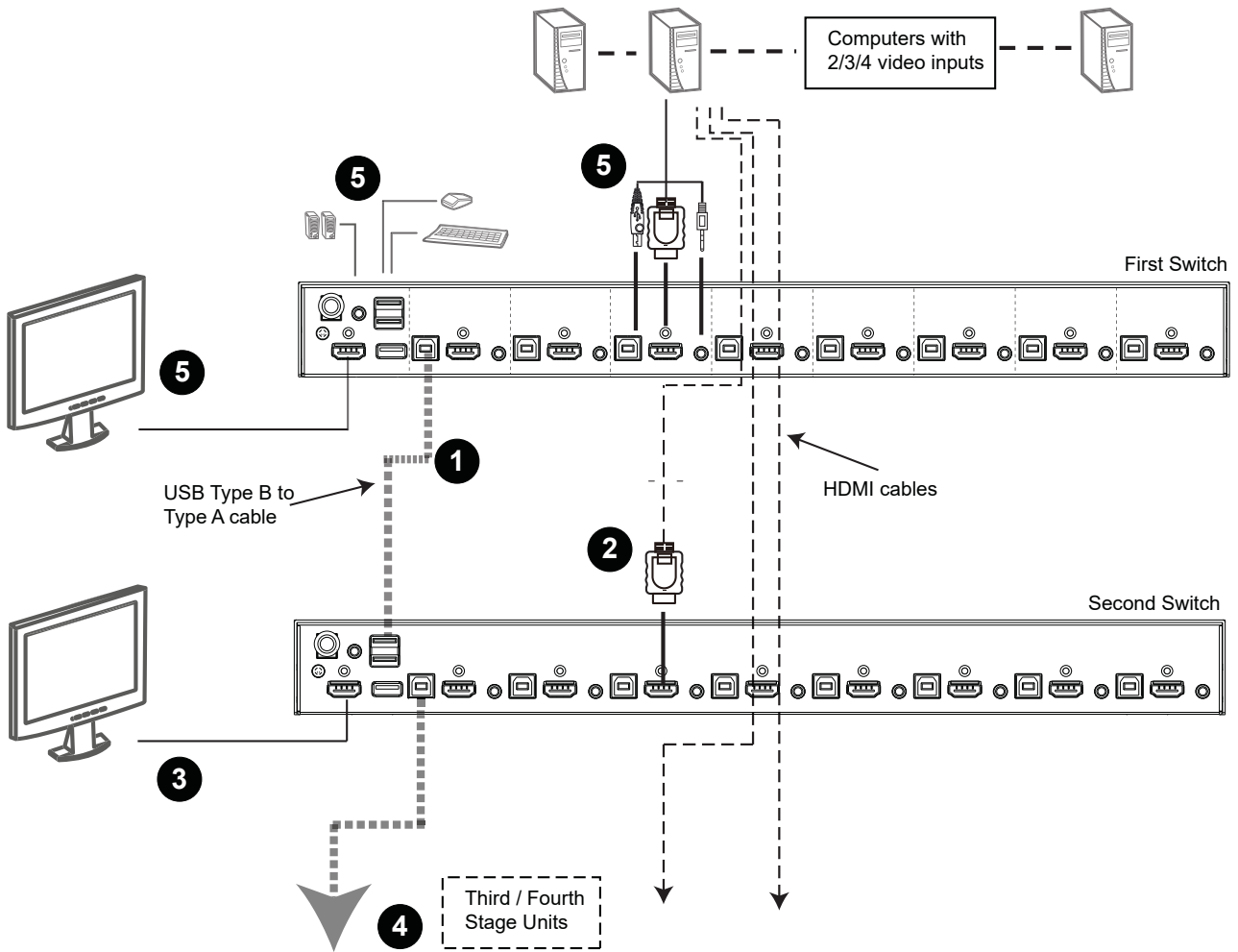

8. Multi-Display Installation

8.2 Grouping Ports into “Vertical” Channels

Once the cables have been connected and multi-display mode has been selected in the on-screen display, the B024-HU08 / B024-HU16 auto-detects the channels and displaying modes. Users can then assign channel numbers as port names (the channels are represented by the vertical columns in the diagram below). So, each Port 1 becomes Channel 1, each Port 2 becomes Channel 2, etc. The ports will all be switched at the same time, channel by channel.

Depending on the number of stages in your stack, a B024-HU08 / B024-HU16 installation offers dual display (two stages), triple display (three stages), quad display (four stages) or multi-display scenarios, up to eight stages. For reference, the example shows a four-stage installation with quad display functionality.

Note: Only one HDMI video signal can be displayed at a time, depending on the configuration of the B024-HU08 / B024-HU16 unit on the first switch.

Channels Diagram

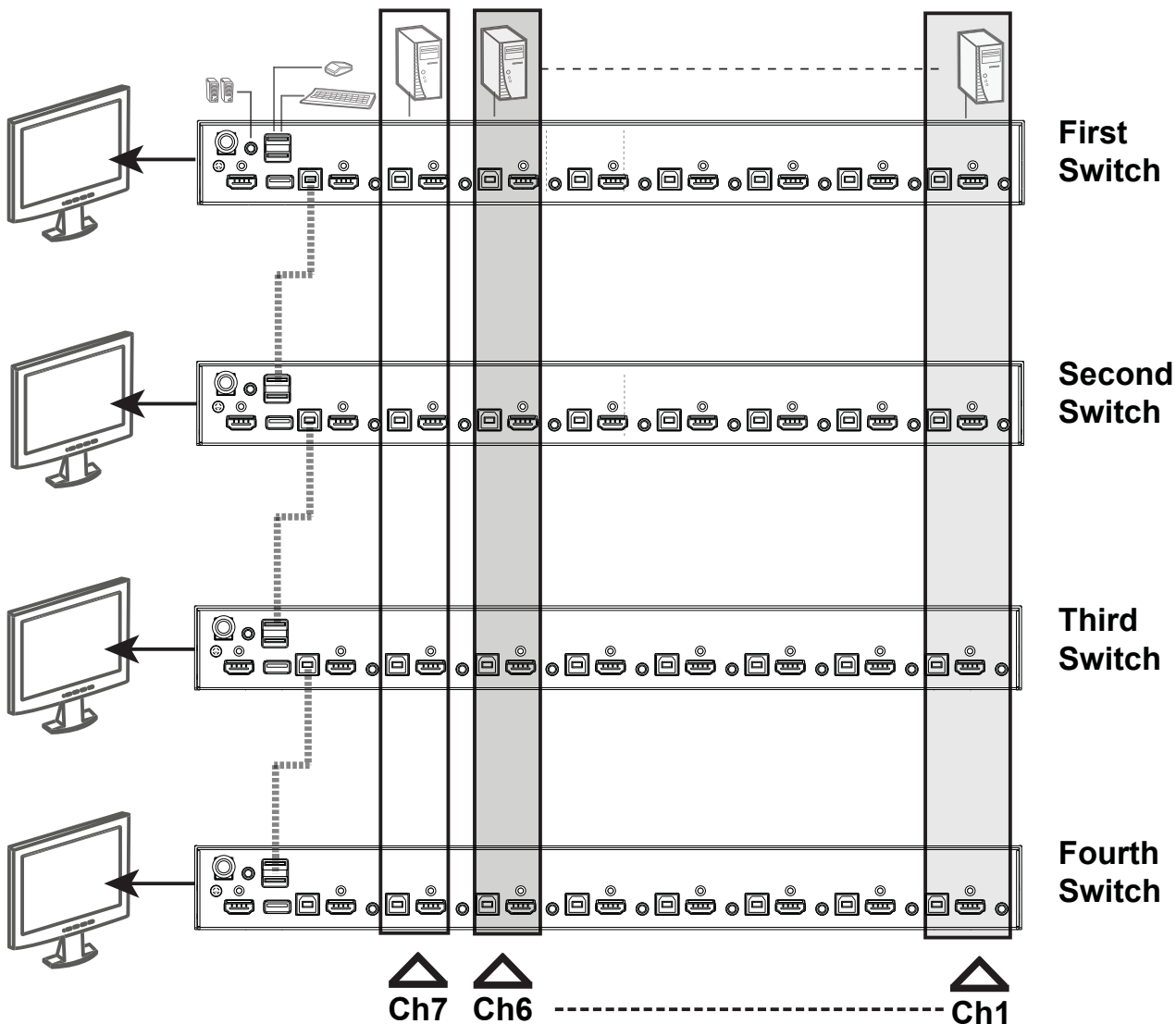

9. Operation

9.1 Hot Plugging

The B024-HU08 / B024-HU16 supports hot plugging – components can be removed and added back into the installation by unplugging their cables from the ports without the need to shut the unit down. In order for hot plugging to work properly, the procedures described below must be followed:

9.1.1 Hot Plugging KVM Ports

In order for the OSD menus to correspond to KVM port changes, you must manually reconfigure the OSD to reflect the new port information. See Table 10-3 and Table 10-4 functions for details.

Note: *If the computer's operating system does not support hot plugging, this function may not work properly.*

9.1.2 Hot Plugging Console Ports

The keyboard, monitor, and mouse can all be hot plugged. When hot plugging the mouse:

- You may unplug and replug the mouse (to reset the mouse, for example), as long as you use the same mouse.
- If you plug in a different mouse, all the computers on the installation must be shut down for 10 seconds, then restarted following the power up sequence described under Steps 6, 7, and 8 in section **7.2.1 Two-Level Installation**.

Note: *If, after hot plugging, there is no response to keyboard and/or mouse input, perform a Keyboard and Mouse Reset by simultaneously pressing the 7 and 8 (B024-HU08) or 15 and 16 (B024-HU16) front panel pushbuttons.*

9.2 Port Selection

The B024-HU08 / B024-HU16 provides three port selection methods to access the computers on the installation: Manual, an OSD (on-screen display) menu system, and Hot keys. See sections **10. On-Screen Display Operation** and **11. Hot Key Operation** for more information.

9.2.1 Manual Port Switching

Use the front panel pushbutton switches to switch to a port manually.

9.3 Port ID Numbering

Each port on a B024-HU08 / B024-HU16 installation is assigned a unique Port ID. You can directly access any computer on any level of the installation by specifying the Port ID that the computer is connected to – either with the OSD (see section **10. On-Screen Display Operation**), or with the Hot key port selection method (see section **11. Hot Key Operation**).

- A computer attached to a master unit has a two digit Port ID (from 01–08 for the B024-HU08, or 01–16 for the B024-HU16) that corresponds to the KVM port number that it is connected to.
- A computer attached to a secondary unit has a four digit Port ID. The first two digits represent the KVM port number on the master and the second two digits represent the KVM port number on the secondary unit that the computer is connected to. For example, a Port ID of 02–08 would refer to a computer that is connected to KVM port 8 of a secondary unit that links back to KVM port 2 of the master unit.

9.4 Powering Off and Restarting

If it becomes necessary to power off a B024-HU08 / B024-HU16 unit, perform the following before restarting it:

1. Unplug the B024-HU08 / B024-HU16 from its power source.
2. Shut down all computers connected to it.

Note: *Unplug the power cords of any computers that have the Keyboard Power On function. Otherwise, the B024-HU08 / B024-HU16 will still receive power from the computers.*

3. Wait 10 seconds, then plug the KVM unit back in.
4. Power on the computers.

Note: *If there are KVM units cascaded from the master B024-HU08 / B024-HU16, all the cascaded units and the computers attached to them must be shut down as well.*

10. On-Screen Display (OSD) Operation

10.1 OSD Overview

The on-screen display (OSD) is a mouse- and keyboard-enabled, menu driven method to handle computer control and switching operations. All procedures start from the OSD main screen.

10.1.1 Manufacturing Number

The “MFG Number” (Manufacturing Number) is an internal serial number used by Tripp Lite’s technical support staff to identify products. This number does not affect a product’s warranty.

10.1.2 OSD Login

The OSD incorporates a two level (administrator/user) password system. Before the OSD main screen displays, a login screen appears requiring a password. If this is the first time that the OSD is used, or if the password function has not been set, simply press **[Enter]**. The OSD main screen displays in administrator mode. In this mode, you have administrator privileges, with access to all administrator and user functions, and can set up operations, including password authorization. If the password function has been set, you must provide an appropriate administrator/user password in order to access the OSD.

10.1.3 OSD Hot Key

You can display the OSD on the console monitor while also viewing the display of any port on the B024-HU08 / B024-HU16 by pressing the **[Scroll Lock]** key twice.

Note: You can optionally change the OSD hot key to the Ctrl key, in which case you would press **[Ctrl]** twice (see section **10.9 OSD Hot Key Control**). With this method, you must press the same **[Ctrl]** key.

10.1.4 OSD Main Screen

When the OSD is invoked, a screen similar to the below appears:



Notes:

1. The diagram depicts the administrator’s main screen. The user main screen does not show the F4 and F6 functions, since these are reserved for the administrator and are not accessible by users.
2. The OSD always starts in list view, with the highlight bar at the same position it was in the last time it was closed.
3. Only the ports that have been set as accessible by the administrator for the current logged in user are visible (see **Table 10-4 SET ACCESSIBLE PORTS**).
4. If the port list is collapsed, click on a switch number, or move the highlight bar to it then press the right arrow key to expand the list. Similarly, to collapse a switch’s port list, click on the switch number, or move the highlight bar to it then press the left arrow key to collapse the list.

10. On-Screen Display (OSD) Operation

10.1.5 OSD Main Screen Headings

Table 10-1

| Header | Description |
|--|---|
| PN | This column lists the port ID numbers for all the KVM ports on the installation. The simplest method to access a particular computer is move the highlight bar to it, then press [Enter] . |
| QV | If a port has been selected for quick view scanning (see Table 10-4 SET QUICK VIEW PORTS), an arrowhead displays in this column. |
|  | Indicated connected computers are powered on and are online. |
| NAME | If a port has been named (see Table 10-4 EDIT PORT NAMES), its name appears in this column. |

10.1.6 OSD Navigation

- To dismiss the menu and deactivate OSD, click the X at the upper right corner of the OSD window or press [Esc].
- To log out, click F8 at the top of the main screen or press [F8].
- To move up or down through the list one line at a time, click the up and down triangle symbols (▲▼) or use the up and down arrow keys. If there are more list entries than what can appear on the main screen, the screen will scroll.
- To move up or down through the list one screen at a time, click the up and down arrow symbols (↑↓), or use the [Pg Up] and [Pg Dn] keys. If there are more list entries than what can appear on the main screen, the screen will scroll.
- To activate a port, double-click it, or move the highlight bar to it then press [Enter].
- After executing any action, the display returns to the menu one level above.

10.2 OSD Functions

OSD functions are used to configure and control the OSD. For example, you can rapidly switch to any port, scan selected ports, limit the list you wish to view, designate a port as a quick view port, create or edit a port name, or make OSD setting adjustments.

To access an OSD function:

1. Either click a function key field at the top of the main screen, or press a function key on the keyboard.
2. In the submenus that appear, make your choice either by double-clicking it or moving the highlight bar to it, then pressing **[Enter]**.
3. Press **[Esc]** to return to the previous menu level.

10.2.1 F1: GOTO

Clicking the **F1** field or pressing **[F1]** activates the GOTO function. GOTO allows you to switch directly to a port either by keying in the port's *Name*, or its Port ID. Enable mouse emulation for independent switching (see section 11.11.3 Mouse Emulation Control) for this function to work.

- To use the name method, key in **1**; key in the port's *Name*; then press **[Enter]** to switch KVM, Audio and USB focus; or **[Spacebar]** to switch KVM and Audio only.
- To use the port ID method, key in **2**; key in the *Port ID*; then press **[Enter]** to switch KVM, Audio and USB focus; or **[Spacebar]** to switch KVM and Audio only.

Note: You can key in a partial name or port ID. In that case, the screen will show all the computers that the user has View rights to (see **Table 10-4 SET ACCESSIBLE PORTS**) that match the name or port ID pattern, regardless of the current list settings (see section **10.2.2 F2: LIST** for details).

To return to the OSD main screen without making a choice, press **[Esc]**.

10. On-Screen Display (OSD) Operation

10.2.2 F2: LIST

This function lets you broaden or narrow the scope of which ports the OSD displays on the main screen. The submenu choices and their meanings are given in table 10-2.

Table 10-2

| Selection | Function |
|-------------------------|--|
| ALL | Lists all of the ports on the installation that have been set accessible by the administrator for the current logged in user. |
| QUICK VIEW | Lists only the ports that have been selected as quick view ports (see Table 10-4 SET QUICK VIEW PORTS). |
| POWERED ON | Lists only the ports that have their attached computers powered on. |
| QUICK VIEW + POWERED ON | Lists only the ports that have been selected as quick view ports (see Table 10-4 SET QUICK VIEW PORTS), and that have their attached computers powered on. |

Move the highlight bar to the choice you want, then press [Enter]. An icon appears before the choice to indicate it is selected.

10. On-Screen Display (OSD) Operation

10.2.3 F3: SET

This function allows the administrator and each user to set up his own working environment. A separate profile for each is stored by the OSD and is activated according to the username that was provided during login.

To change a setting:

1. Double-click it; or move the highlight bar to it, then press **[Enter]**.
2. After you select an item, a submenu with further choices appears. To make a selection, either double-click or move the highlight bar to it, then press **[Enter]**. An icon appears before the selected choice to indicate which one it is. The settings are explained in table 10-3:

Table 10-3

| Selection | Function |
|--------------------------|---|
| OSD HOT KEY | Selects which hot key activates the OSD function: [Scroll Lock] [Scroll Lock] or [Ctrl] [Ctrl] . Because the [Ctrl] key combination may conflict with programs running on the computers, the default is the [Scroll Lock] combination. |
| PORT ID DISPLAY POSITION | Allows each user to customize the position where the port ID appears on the screen. The default is the upper left corner, but users can choose to have it appear anywhere on the screen. Use the mouse or the arrow keys plus [Pg Up] , [Pg Dn] , [Home] , [End] , and 5 (on the numeric keypad with Num Lock off), to position the port ID display, then double-click or press [Enter] to lock the position and return to the Set submenu. |
| PORT ID DISPLAY DURATION | Determines how long a port ID displays on the monitor after a port change has taken place. The choices are: 3 Seconds (default) and Always Off. |
| PORT ID DISPLAY MODE | Selects how the port ID is displayed: the port number plus the port name (PORT NUMBER + PORT NAME) (default); the port number alone (PORT NUMBER); or the port name alone (PORT NAME). |
| SCAN DURATION | Determines how long the focus dwells on each port as it cycles through the selected ports in Auto Scan mode (see section 10.2.7 F7: SCAN). Key in a value from 1–255 seconds, then press [Enter] . Default is 5 seconds; a setting of 0 disables the SCAN function. Note: Enable mouse emulation for auto scan to work (see section 11.11.3 Mouse Emulation Control). |
| SCAN-SKIP MODE | Selects which computers will be accessed under skip mode (see section 10.2.5 F5: SKP), and Auto Scan mode (see section 10.2.7 F7: SCAN). The choices are: ALL - All the ports which have been set accessible (see Table 10-4 SET ACCESSIBLE PORTS ; QUICK VIEW - Only those ports which have been set accessible and have been selected as quick view ports (see Table 10-4 SET QUICK VIEW PORTS); POWERED ON - Only those ports which have been set accessible and are powered on; QUICK VIEW + POWERED ON - Only those ports which have been set accessible and have been selected as quick view ports and are powered on. The default is ALL. Note: The quick view choices only show up on the administrator's screen, since only the administrator has Quick View setting rights (see Table 10-4 SET QUICK VIEW PORTS). Enable mouse emulation for the scan-skip mode to function. |
| SCREEN BLANKER | If there is no input from the console for the amount of time set with this function, the screen is blanked. Key in a value from 1–30 minutes, then press [Enter] . The default setting of 0 disables this function. |
| HOT KEY COMMAND MODE | Enables/disables the hot key command function in case of conflict with programs running on the connected computers occurs. |
| HOT KEY | Sets the keyboard shortcut for invoking Hot Key Mode (see section 11.2 Hot Key Setting Mode). Choices are: default setting of [NUM LOCK] + - (minus) and [CTRL] + [F12] . |
| OSD LANGUAGE | Sets the language used in the OSD. Choices are: English (default), German, Japanese, Simplified Chinese, Traditional Chinese, Spanish, French and Russian. |

10. On-Screen Display (OSD) Operation

10.2.4 F4: ADM

F4 is an administrator-only function. It allows the administrator to configure and control the overall operation of the OSD. To change a setting, double-click it or use the up and down arrow keys to move the highlight bar to it, then press **[Enter]**.

When an item is selected, a submenu with further choices to select from appears. Double-click an item or move the highlight bar to it, then press **[Enter]**. An icon appears before the selected item so that you know which one it is. The settings are explained in table 10-4:

Table 10-4

| Header | Description |
|------------------------|---|
| SET USER LOGIN | <p>This function is used to set usernames and passwords for the administrator and users:</p> <ol style="list-style-type: none"> 1. Usernames and passwords for one administrator and four users can be set. 2. After selecting the administrator field or one of the user fields, a screen that allows you to key in the username and password appears. Usernames and passwords can be from 1 to 16 characters long and can consist of any combination of letters and numbers (A–Z, 0–9) and some additional keys: * () + : - , ? . / space. 3. For each individual, key in the username and password, confirm the password, then press [Enter]. 4. To modify or delete a previous username and/or password, use the backspace key to erase individual letters or numbers. Press [Enter] when done. <p>Note: Usernames and passwords are not case sensitive. Usernames are displayed in capital letters in the OSD.</p> |
| SET ACCESSIBLE PORTS | <p>This function allows the administrator to define user access to the computers on the installation on a port-by-port basis.</p> <p>For each user, select the target port; then press the [Spacebar] to cycle through the choices: F (full access), V (view only), or blank. Repeat until all access rights have been set, then press [Enter]. The default is F for all users on all ports.</p> <p>Notes:</p> <ul style="list-style-type: none"> • A blank setting means that no access rights are granted. The port will not show up on the user's LIST on the main screen. • The administrator always has full access to all ports. |
| SET LOGOUT TIMEOUT | <p>If there is no input from the console for the amount of time set with this function, the user is automatically logged out. A login is necessary before the console can be used again. This enables other users to gain access to the computers when the original user is no longer accessing them, but has forgotten to log out.</p> <p>To set the timeout value, key in a number from 1–180 minutes, then press [Enter]. The default setting of 0 disables this function.</p> <p>Note: This feature does not function if Set Login Mode is disabled. See Table 10-4 SET LOGIN MODE.</p> |
| EDIT PORT NAMES | <p>To help remember which computer is attached to a particular port, every port can be given a name. This function allows the administrator to create, modify, or delete port names.</p> <p>To edit a port name:</p> <ol style="list-style-type: none"> 1. Click the port, or use the navigation keys to move the highlight bar to it, then press [Enter]. 2. Key in the new port name, or modify/delete the old one. The maximum number of characters allowed for the port name is 12. Allowed characters include: <ul style="list-style-type: none"> • All alpha characters: A–Z • All numeric characters: 0–9 • * () + : - , ? . / Case does not matter; the OSD displays the port name in all capitals no matter how they are keyed in. 3. When finished editing, press [Enter] to have the change take effect. To abort the change, press [Esc]. |
| RESTORE DEFAULT VALUES | <p>This function is used to undo all changes and return the setup to the original factory default settings (see section 14.1 Factory Default Hot Keys and Settings) except for the port name list, username and password information, which are saved.</p> |
| CLEAR THE NAME LIST | <p>This function clears the port name list.</p> |
| ACTIVATE BEEPER | <p>Choices are Y (on), or N (off). When activated, the beeper sounds whenever a port is changed; when activating the Auto Scan function (see section 10.2.7 F7: SCAN); or if an invalid entry is made on an OSD menu. The default is Y.</p> |

10. On-Screen Display (OSD) Operation

| | |
|-------------------------------|---|
| SET QUICK VIEW PORTS | <p>This function lets the administrator select which ports to include as quick view ports.</p> <ul style="list-style-type: none"> • To select/deselect a port as a quick view port, double-click the port, or use the navigation keys to move the highlight bar to it, then press [Spacebar]. • When a port has been selected as a quick view port, an icon displays in the QV column of the LIST on the main screen. When a port is deselected, the icon disappears. • If one of the quick view options is chosen for the LIST view (see section 10.2.2 F2: LIST), only a port that has been selected here will display on the list. • If one of the quick view options is chosen for auto-scanning (see Table 10-3 SCAN-SKIP MODE), only a port that has been selected here will be auto-scanned. <p>The default has no ports selected for quick view.</p> |
| SET OPERATING SYSTEM | <p>This function allows the administrator to define the operating system for the computer connected to each KVM port. The default is WIN (PC compatible).</p> <p>To set the port operating system:</p> <ol style="list-style-type: none"> 1. From the list, select the port for which you wish to set the computer's operating system. 2. Set the operating system by pressing [Spacebar] to cycle through WIN, MAC, SUN, or OTHER. 3. Press [Esc] to exit. The operating system you selected is assigned to the KVM port. |
| FIRMWARE UPGRADE | <p>In order to upgrade the B024-HU08 / B024-HU16 firmware (see section 13. Firmware Management Utility), you must first enable Firmware Upgrade mode with this setting.</p> <p>When you bring up this menu, the current firmware version levels are displayed. Select Y to enable Firmware Upgrade mode, or N to leave this menu without enabling it.</p> |
| KEYBOARD LANGUAGE | <p>Sets the language for the computer keyboard attached to the KVM port. To select a keyboard language, double-click it, or use the navigation keys to move the highlight bar to it, then press [Enter].</p> <p>Choices are: Auto (default), English (US), English (UK), German (GER.), German (SWISS), French, Hungarian, Italian, Japanese, Korean, Russian, Spanish, Swedish, Traditional Chinese, and Simplified Chinese.</p> |
| MOUSE EMULATION | <p>Enables / disables mouse emulation function.</p> <p>Note: Supported in the first level of an installation only. Enable mouse emulation to perform any independent switching of a port and for Auto Scan Mode or Skip Mode to function.</p> |
| ACTIVATE MULTI-DISPLAY | <p>Enables multi-display mode for dual, triple or quad displays in multiple-monitor installations where each computer is fitted with multiple video cards. See section 8. Multi-display Installation for full details.</p> <p>Note: multi-display mode must be enabled on the OSD before the cables are connected.</p> |
| OSD CONFIG BACKUP/ RESTORE | <p>Enters OSD Configuration Backup / Restore mode. The Firmware Management Utility enables backup of the current OSD configuration of the B024-HU08 / B024-HU16, and restore when necessary. Storing the OSD configuration settings is useful when deploying more than one installation that uses the same settings. See section 13.7 OSD Configuration Backup/Restore for full details.</p> |
| SET LOGIN MODE | <p>This function allows the administrator to request users to login or not. When the login dialog box is disabled, the system disables the login/logout function. If the system is re-started, the login/logout function remains disabled.</p> |

10. On-Screen Display (OSD) Operation

10.2.5 F5: SKP

Clicking the F5 field or pressing **[F5]** invokes Skip (SKP) mode. This function enables you to easily skip backward or forward – switching the console focus from the currently active computer port to the previous or next accessible one.

Enable mouse emulation for Skip mode to work (see section **11.11.3 Mouse Emulation Control**).

- The selection of computers available for skip mode switching is made with the Scan–Skip mode setting under the F3: SET function (see **Table 10-3**).
- When you are in skip mode:
 - Press **[←]** to skip to the previous accessible port on the list, in skip mode.
 - Press **[→]** to skip to the next accessible port on the list, in skip mode.
 - Press **[↑]** to skip to the next accessible port. If the next accessible port has cascaded a switch, then it skips to the first accessible port of that switch.
 - Press **[↓]** to skip to the previous accessible port. If the previous accessible port has cascaded a switch, then it skips to the last accessible port of that switch.
- Note:** When skipping, you can skip only to the previous or next accessible computer that is in the Scan-Skip mode selection (see **Table 10-3**).
- If a port has been selected for Scan–Skip mode, when the focus switches to that port a left/right triangle symbol appears before its port ID display. When the port ID with the triangle symbol displays, the background screen is blank.
- While skip mode is in effect, the console will not function normally. You must exit skip mode in order to regain control of the console.
- When the selected port displays, skip mode is automatically disabled.
- To exit skip mode, press **[Spacebar]** or **[Esc]**.

10.2.6 F6: BRC

F6 is an administrator-only function. Clicking the F6 field, or pressing **[F6]**, invokes Broadcast (BRC) mode. When this function is in effect, commands sent from the console are broadcast to all available computers on the installation.

This function is particularly useful for operations that need to be performed on multiple computers, such as performing a system wide shutdown, installing or upgrading software, etc.

- While BRC mode is in effect, a speaker symbol appears before the port ID display of the port that currently has the console focus. When the port ID with the speaker symbol displays, the background screen is blank.
- While BRC mode is in effect, the mouse will not function normally. You must exit BRC mode in order to regain control of the mouse.
- To exit BRC mode, invoke the OSD (with the OSD hot key), then click the F6 field, or press **[F6]**, to turn BRC mode off.
- When BRC mode is in effect, the Scroll Lock LED flashes. It stops flashing and reverts to normal status when you exit BRC.

10.2.7 F7: SCAN

Clicking the F7 field or pressing **[F7]** invokes Auto Scan mode. This function enables automatic switching among the available computers at regular intervals so that you can monitor their activity without having to switch manually. Enable mouse emulation for Auto Scan to work (see section **11.11.3 Mouse Emulation Control**).

- The selection of computers to be included for auto-scanning is made with the Scan–Skip mode setting under the F3: SET function (see **Table 10-3**).
- The amount of time that each port displays for is set with the Scan Duration setting under the F3: SET function (see **Table 10-3**). When you want to stop at a particular location, press the **[Spacebar]** to stop scanning.
- If the scanning stops on an empty port, or one where the computer is attached but is powered off, the monitor screen will be blank, and the mouse and keyboard will have no effect. After the Scan Duration time is up, the scan function will move on to the next port.
- As each computer is accessed, an S appears in front of the port ID display to indicate that it is being accessed under Auto Scan mode. When the port ID with the symbol displays, the background screen is blank.
- While Auto Scan mode is in effect, the console will not function normally. You must exit Auto Scan mode in order to regain control of the console.
- While you are in Auto Scan mode, you can pause the scanning in order to keep the focus on a particular computer either by pressing **P**, or with a left click of the mouse. See section **11.4.1 Invoking Auto Scan** for details.
- To exit Auto Scan mode, press the **[Spacebar]** or **[Esc]**.

10. On-Screen Display (OSD) Operation

10.2.8 F8: LOUT

Clicking the **F8** field, or pressing **[F8]** logs you out of OSD control of the computers, and blanks the console screen. This is different from simply pressing **[Esc]** when you are at the main screen to deactivate the OSD. With this function, you must log in all over again to regain access to the OSD, whereas with **[Esc]**, simply tap the OSD hot key to reenter the OSD.

Notes:

- When you reenter the OSD after logging out, the screen stays blank except for the OSD main screen. You must input your username and password before you can continue.
- If you reenter the OSD after logging out, and immediately use **[Esc]** to deactivate the OSD without having selected a port from the OSD menu, a null port message displays on the screen. The OSD hot key will bring up the main OSD screen.

11. Hot Key Operation

11.1 Hot Key Commands

Hot key commands enable switching between KVM ports directly from the keyboard. The B024-HU08 / B024-HU16 provides the following hot key command features:

- Selecting the Active Port
- Auto Scan Mode Switching
- Skip Mode Switching
- Computer Keyboard/Mouse Reset
- Enable/Disable Mouse Emulation

The following setting can also be controlled in Hot Key Setting Mode:

- Setting the Beeper
- Setting the Quick Hot Key
- Setting the OSD Hot Key
- Setting the Port Operating System
- Restoring the OSD Default Values

Note: Enable mouse emulation to perform any independent switching of a port and for Auto Scan Mode or Skip Mode to function (see section 11.11.3 Mouse Emulation Control).

11.2 Hot Key Setting Mode

Hot Key Setting Mode is used to set up your B024-HU08 / B024-HU16 switch configuration. All operations begin with invoking Hot Key Setting Mode (HSM).

11.2.1 Invoking HSM

To invoke HSM, perform the following:

1. Press and hold **[Num Lock]**;
2. Press and release **[-]**;
3. Release **[Num Lock]**:
[Num Lock] + [-]

or

1. Hold down the **[Ctrl]** key.
2. Press and release the **[F12]** key.
3. Release the **[Ctrl]** key:
[Ctrl] + [F12]

When HSM is active:

- A command line appears on the monitor screen. The command line prompt is the word Hotkey in white text on a blue background, and displays the subsequent hot key information that you key in.
- Ordinary keyboard and mouse functions are suspended – only hot key compliant keystrokes (described in the sections that follow), can be input.

Pressing [Esc] exits HSM.

11.3 Select the Active Port

Each KVM port is assigned a port ID (see section 9.3 Port ID Numbering). You can directly access any computer on the installation with a hot key combination that specifies the port ID of the KVM port that a computer is connected to. To access a computer using hotkeys:

1. Invoke HSM with the **[Num Lock] + [-]** or **[Ctrl] + [F12]** combination.
2. Key in the port ID.
The port ID numbers display on the command line as you key them in. If you make a mistake, use **[Backspace]** to erase the wrong number.
3. Press **[Enter]**.
After you press **[Enter]**, the KVM focus switches to the designated computer and you automatically exit HSM.

Note: In HSM, KVM focus will not switch to a port if an invalid switch or port number is entered. The hotkey command line will continue to display on the screen until you enter a valid switch and port number combination, or exit HSM.

11. Hot Key Operation

11.4 Auto Scan Mode

Auto Scan automatically switches, at regular intervals, among all the KVM ports that have been set as accessible under Scan–Skip Mode, so that their activity can be monitored automatically. See **Table 10-3 Scan–Skip Mode** for more information.

11.4.1 Invoking Auto Scan

To start *Auto Scan*, key in the following hot key combination:

1. Enable mouse emulation (see section **11.11.3 Mouse Emulation Control**).
2. Invoke HSM with the **[Num Lock] + [-]** or **[Ctrl] + [F12]** combination.
3. Press **[A]**. After you press **[A]**, then **[Enter]**, you automatically exit *HSM*, and enter *Auto Scan* mode.
 - While in *Auto Scan* mode, you can pause the scanning in order to keep the focus on a particular computer either by pressing **[P]** or with a left click of the mouse. During the time that auto-scanning is paused, the command line displays: **Auto Scan: Paused**.
 - *Pausing* when you want to keep the focus on a particular computer is more convenient than exiting *Auto Scan* mode because when you resume scanning, you start from where you left off. If, on the other hand, you exited and restarted, scanning would start over from the very first computer on the installation.
 - To resume Auto Scanning, press any key or left-click. Scanning continues from where it left off.
 - While *Auto Scan* mode is in effect, ordinary keyboard and mouse functions are suspended – only *Auto Scan* mode compliant keystrokes and mouse clicks can be input. You must exit *Auto Scan* mode in order to regain normal control of the console.
4. To exit *Auto Scan* mode, press **[Esc]** or **[Spacebar]**. Auto-scanning stops when you exit *Auto Scan* mode.

11.5 Skip Mode

This feature allows you to switch between computers in order to monitor them manually. You can dwell on a particular port for as long as you like – as opposed to auto-scanning, which automatically switches after a fixed interval. To invoke Skip mode, key in the following hotkey combination:

1. Enable mouse emulation (see section **11.11.3 Mouse Emulation Control**).
2. Invoke *HSM* with the **[Num Lock] + [-]** or **[Ctrl] + [F12]** combination.
3. Key in **[Arrow]**, where [Arrow] refers to one of the arrow keys. After you press an arrow, you automatically exit HSM and enter Skip Mode, where you can switch ports as follows:

| Arrow Key | Action |
|-----------|---|
| ← | Skips to the previous computer on the list, in skip mode. (See Table 10-3 Scan-Skip Mode for information regarding accessible ports.) |
| → | Skips to the next computer on the list, in skip mode. |
| ↑ | Skips to the next accessible port. If the next accessible port has cascaded a switch, then it skips to the first accessible port of that switch, in skip mode. |
| ↓ | Skips to the previous accessible port. If the previous accessible port has cascaded a switch, then it skips to the last accessible port of that switch, in skip mode. |

- Once the switch is in *Skip* mode, you can keep on skipping by pressing the arrow keys. It is not necessary to use the **[Num Lock] + [-]** combination again.
 - While Skip mode is in effect, ordinary keyboard and mouse functions are suspended – only Skip mode compliant keystrokes can be input. You must exit Skip mode to regain normal control of the console.
4. To exit Skip mode, press **[Esc]** or **[Spacebar]**.

Note: Enable mouse emulation to perform any independent switching of a port and for Auto Scan Mode or Skip Mode to function (see section **11.11.3 Mouse Emulation Control**).

11. Hot Key Operation

11.6 Keyboard/Mouse Reset

If the keyboard or mouse cease to function on the computer connected to the currently selected port, you can perform a keyboard/mouse reset on the computer. This function is essentially the same as unplugging and replugging the keyboard and mouse on the target computer. To perform a computer keyboard/mouse reset, key in the following hot key combination:

1. Invoke HSM with the **[Num Lock] + [-]** or **[Ctrl] + [F12]** combination.
2. Press **[F5]**.

After you press [F5] you automatically exit HSM and regain keyboard and mouse control on the computer connected to the KVM port. If you fail to regain keyboard / mouse control on the computer after pressing [F5], perform a console keyboard and mouse reset. For more information, see section **5.1 Port LEDs**.

11.7 Hot Key Beeper Control

The beeper (see **Table 10-4 ACTIVATE BEEPER**) can be toggled on and off with hot keys. To toggle the beeper, key in the following hotkey combination:

1. Invoke HSM with the **[Num Lock] + [-]** or **[Ctrl] + [F12]** combination.
2. Press **[B]**.

Pressing [B] toggles the beeper on or off. The command line displays *Beeper On* or *Beeper Off* for one second; then the message disappears and you automatically exit HSM.

11.8 Quick Hot Key Control

The Quick Hot Key (see **Table 10-3 HOT KEY**) can be toggled between **[Num Lock] + [-]** and **[Ctrl] + [F12]**. To toggle the Quick Hot Key:

1. Invoke HSM with the **[Num Lock] + [-]** or **[Ctrl] + [F12]** combination.
2. Press **[H]**.

After you press [H], the command line displays *HOTKEY HAS BEEN CHANGED* for one second; then the message disappears and you automatically exit HSM.

11.9 OSD Hotkey Control

The OSD Hotkey (see **Table 10-3 OSD HOT KEY**) can be toggled between **[Scroll Lock]**, **[Scroll Lock]** and **[Ctrl]**, **[Ctrl]**. To toggle the OSD Hotkey, key in the following hotkey combination:

1. Invoke HSM with the **[Num Lock] + [-]** or **[Ctrl] + [F12]** combination.
2. Press **[T]**.

After you press [T], the command line displays *HOTKEY HAS BEEN CHANGED* for one second; then the message disappears and you automatically exit HSM.

11.10 Port OS Control

A port's operating system can be changed to match that of the computer attached to the port. To change a port's operating system, key in the following hot key combination:

1. Invoke HSM with the **[Num Lock] + [-]** or **[Ctrl] + [F12]** combination.
2. Key in **[Function]**, where [Function] refers to one of the function keys in the following table:

| Function Key | Action |
|--------------|-----------------------------|
| F1 | Sets the Port OS to Windows |
| F2 | Sets the Port OS to Mac |
| F3 | Sets the Port OS to Sun |

After pressing a function key, HSM is exited automatically.

11. Hot Key Operation

11.11 Restore Default Values

This administrator-only hot key restores the KVM switch's default values. To restore default values, key in the following hot key combination:

1. Invoke *HSM* with the **[Num Lock] + [-]** or **[Ctrl] + [F12]** combination.
2. Press **[R]**.
3. Press **[Enter]**.

After pressing [Enter], the command line displays *RESET TO DEFAULT SETTING* for three seconds; then the message disappears and you automatically exit *HSM*.

11.11.1 USB Reset

If the USB loses focus and needs to be reset, perform the following:

1. Invoke *HSM* with the **[Num Lock] + [-]** or **[Ctrl] + [F12]** combination.
2. Press and release **[F5]**.

11.11.2 Hot Key Beeper Control

The beep can be enabled or disabled. The default setting is enabled. To disable, perform the following:

1. Invoke *HSM* with the **[Num Lock] + [-]** or **[Ctrl] + [F12]** combination.
2. Press and release **[B]**.

11.11.3 Mouse Emulation Control

The default setting is enabled. To disable, perform the following:

1. Invoke *HSM* with the **[Num Lock] + [-]** or **[Ctrl] + [F12]** combination.
2. Press and release **[M]**.

This procedure is a toggle; repeat the actions above to enable.

11. Hot Key Operation

11.12 HSM Summary Table

Invoke *HSM* with the [Num Lock] + [-] or [Ctrl] + [F12] combination, then key in one of the following keys to perform the corresponding function:









| Key | Function |
|---------------------|--|
| [PN] [Enter] | Switches KVM, Audio, and USB focus directly to the computer that corresponds to that port ID. (PN = port number) |
| [PN]* [K] [Enter] | Switches KVM focus only directly to the computer that corresponds to that port ID. (PN = port number) |
| [PN]* [U] [Enter] | Switches USB focus only directly to the computer that corresponds to that port ID. (PN = port number) Note: This hot key functions on the first level of an installation only. |
| [A] [Enter] | Starts Auto Scan. The KVM focus cycles from port to port at the default 5-second intervals. |
| [A] [n] [Enter] | Starts Auto Scan at n-second intervals. (n = 1–255 seconds) |
| [H] | Toggles between the default ([Num Lock] [-]) and alternate ([Ctrl] [F12]) HSM invocation keys. |
| [T] | Toggles between the default ([Scroll Lock] [Scroll Lock]) and alternate ([Ctrl] [Ctrl]) OSD Hotkey. |
| [F1] | Sets the port OS to Windows. |
| [F2] | Sets the port OS to Mac. |
| [F3] | Sets the port OS to Sun. |
| [F5] | Performs a keyboard / mouse reset on the target computer. |
| [B] | Enables/disables the beeper. |
| [R] [Enter] | Resets the hot key settings to their default status (see section 14.1 Factory Default Hot Keys and Settings). |
| [M] | Enables/disables mouse emulation. |
| ← | Skips to the previous computer on the list, in skip mode. |
| → | Skips to the next computer on the list, in skip mode. |
| ↑ | Skips to the next accessible port. If the next accessible port has cascaded a switch, then it skips to the first accessible port of that switch, in skip mode. |
| ↓ | Skips to the previous accessible port. If the previous accessible port has cascaded a switch, then it skips to the last accessible port of that switch, in skip mode. |
| [ESC] or [Spacebar] | Exits hot key setting mode. |

Note: Enable mouse emulation to perform any independent switching of a port and for Auto Scan Mode or Skip Mode to function (see section 11.11.3 Mouse Emulation Control).

12. Keyboard Emulation

12.1 Mac Keyboard

A PC-compatible (101/104 key) keyboard can emulate the functions of a Mac keyboard. The emulation mappings are shown in the table below:







| PC Keyboard | Mac Keyboard |
|---|---|
| [Shift] | Shift |
| [Ctrl] | Ctrl |
|  |  |
| [Ctrl] [1] |  |
| [Ctrl] [2] |  |
| [Ctrl] [3] |  |
| [Ctrl] [4] |  |
| [Alt] | Alt |
| [Print Screen] | F13 |
| [Scroll Lock] | F14 |
|  | = |
| [Enter] | Return |
| [Backspace] | Delete |
| [Insert] | Help |
| [Ctrl]  | F15 |

Note: When using key combinations, press and release the first key (Ctrl), then press and release the activation key.

12. Keyboard Emulation

12.2 Sun Keyboard

A PC-compatible (101/104 key) keyboard can emulate the functions of a Sun keyboard when the Control key (Ctrl) is used in conjunction with other keys. The corresponding functions are shown in the table below:

| PC Keyboard | Sun Keyboard |
|---|---|
| [Ctrl] [T] | Stop |
| [Ctrl] [F2] | Again |
| [Ctrl] [F3] | Props |
| [Ctrl] [F4] | Undo |
| [Ctrl] [F5] | Front |
| [Ctrl] [F6] | Copy |
| [Ctrl] [F7] | Open |
| [Ctrl] [F8] | Paste |
| [Ctrl] [F9] | Find |
| [Ctrl] [f10] | Cut |
| [Ctrl] [1] |  |
| [Ctrl] [2] |  |
| [Ctrl] [3] |  |
| [Ctrl] [4] |  |
| [Ctrl] [H] | Help |
|  | Compose |
|  |  |

Note: When using key combinations, press and release the first key (Ctrl), then press and release the activation key.

13. Firmware Management Utility

13.1 Introduction

The purpose of the Windows-based Firmware Management Utility is to provide an automated process for upgrading all B024-HU08 / B024-HU16 switches in an installation. The program comes as part of a Firmware Upgrade Package that is specific for each device.

As new firmware versions become available, new firmware upgrade packages are posted on our website. Check the website regularly to find the latest information and packages.

13.1.1 Downloading the Firmware Upgrade Package

To download the firmware upgrade package:

1. From a computer that is not part of your KVM installation go to tripplite.com/support and search for the model name that relates to your device. A list of available firmware upgrade packages appears.
2. Choose the firmware upgrade package that you wish to install (usually the most recent) and download it to your computer.

13.2 Preparation

To prepare for the firmware upgrade, perform the following:

1. Use the firmware upgrade cable provided with the unit to connect a COM port on your computer to the firmware upgrade port of your switch.

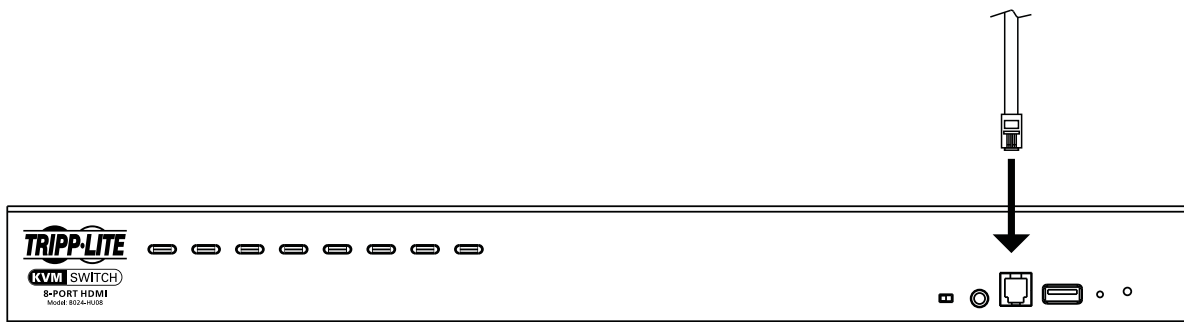
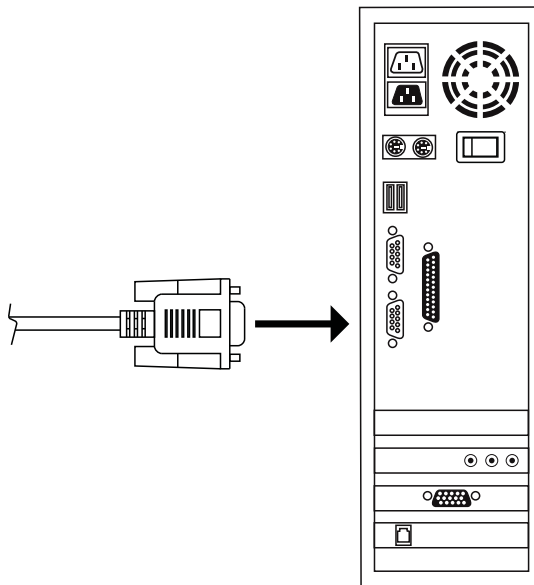

2. Shut down all the computers on the KVM installation.
3. From your KVM switch console, login to the OSD as the administrator (see section **10.2**) and select the F4 ADM function.
4. Scroll down to FIRMWARE UPGRADE. Press **[Enter]**, then press **[Y]** to invoke Firmware Upgrade mode (see **Table 10-4**).

13. Firmware Management Utility

13.3 Starting the Upgrade

To upgrade the firmware:

1. Run the downloaded firmware upgrade package file either by double-clicking the file icon, or by opening a command line and entering the full path to it.

The Firmware Upgrade Utility welcome screen appears:

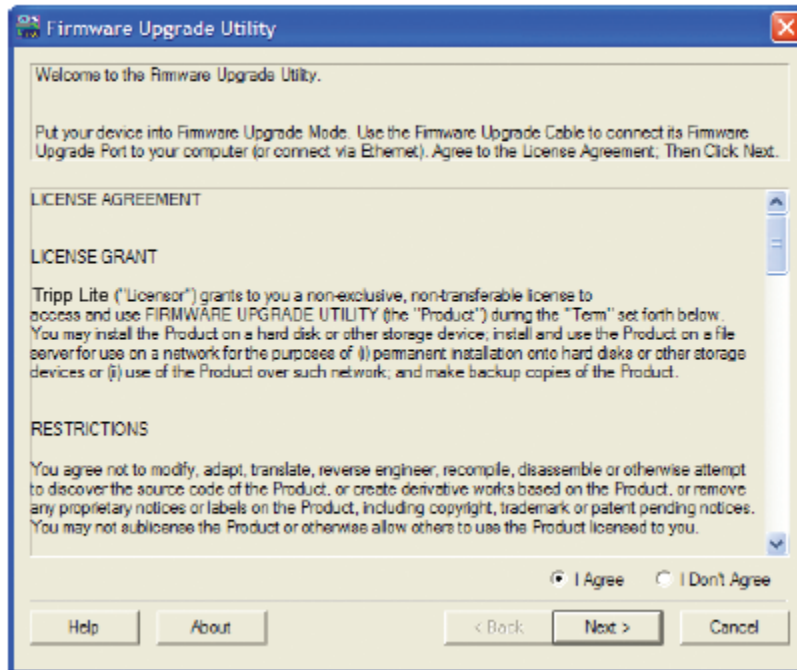

Note: The screens shown in this section are for reference only. The wording and layout of the actual screens displayed by the Firmware Upgrade Utility may vary slightly from these examples.

2. Read and agree to the License Agreement (enable the I Agree radio button).
3. Click [**Next**] to continue. The Firmware Upgrade Utility main screen appears. The devices capable of being upgraded are listed in the Device List panel:

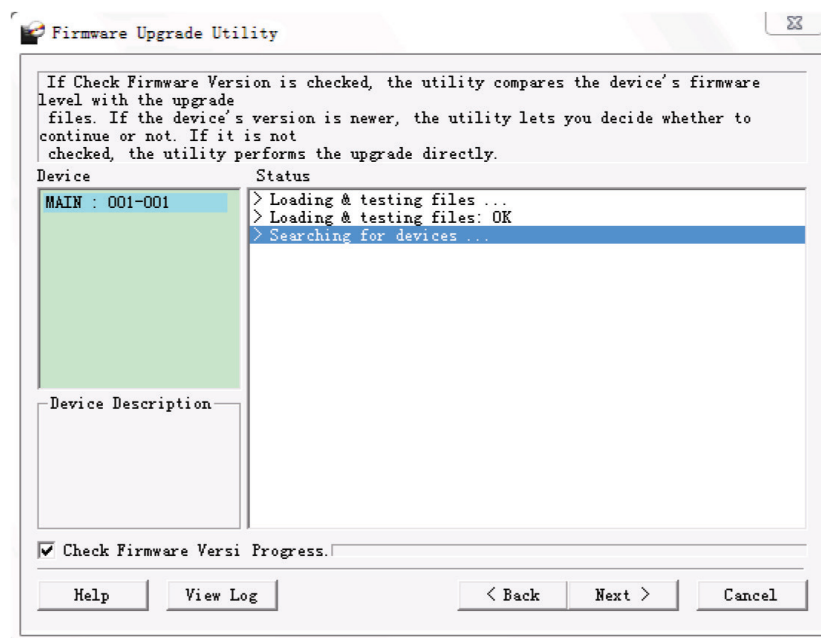

13. Firmware Management Utility

4. Click **[Next]** to perform the upgrade.

If you enabled *Check Firmware Version*, the Utility compares the device's firmware level with that of the upgrade files. If it finds that the device's version is higher than the upgrade version, it brings up a dialog box informing you of the situation and gives you the option to continue or cancel.

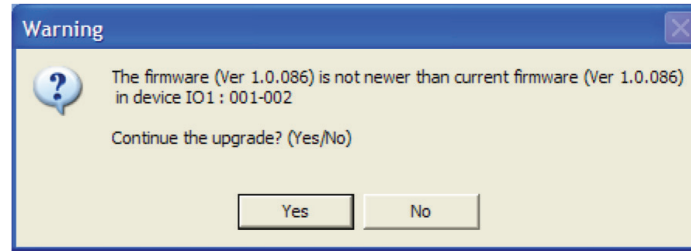

If you did not enable *Check Firmware Version*, the Utility installs the upgrade files without checking whether they are a higher level, or not. As the upgrade proceeds, status messages appear in the *Status Messages* panel, and the progress toward completion is shown on the *Progress* bar.

13.4 Upgrade Succeeded

After the upgrade has completed, a screen appears to inform you the procedure was successful.

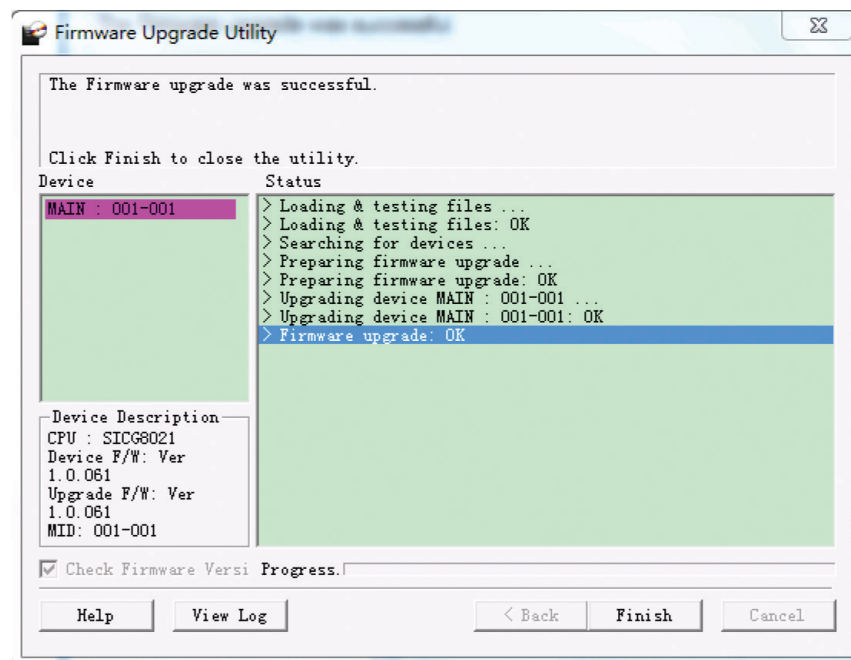

13.5 Upgrade Failed

If the Upgrade Succeeded screen does not appear, it means the upgrade failed to complete successfully. See section **13.6 Firmware Upgrade Recovery** for how to proceed.

13. Firmware Management Utility

13.6 Firmware Upgrade Recovery

There are three conditions that call for firmware upgrade recovery:

- A firmware upgrade is manually aborted
- The mainboard firmware upgrade fails
- The I/O firmware upgrade fails

To perform a firmware upgrade recovery, perform the following:

1. Power off the switch.
2. Connect the *Firmware Upgrade Cable* to its *Firmware Upgrade Port*.
3. Slide the *Firmware Upgrade Recovery Switch* to the **Recover** position.
4. Power the switch back on and repeat the upgrade procedure.
5. After the switch has been successfully upgraded, power it off, and slide the *Firmware Upgrade Recovery Switch* back to the **Normal** position.
6. If the switch is one of the cascaded switches, plug it back into the installation.
7. Power the switch back on.

13.7 OSD Configuration Backup/Restore

The Firmware Management Utility lets you back up the current OSD configuration of the B024-HU08 / B024-HU16, and restore it when necessary. Storing the OSD configuration settings is useful when deploying more than one installation that uses the same settings.

13.7.1 Backup

Follow these steps to store a backup file to a local computer:

1. Make sure your computer is connected to the B024-HU08 / B024-HU16.
See section **13.2 Preparation** and follow steps 1–3.
2. When you have selected the **F4 ADM** function, scroll down to OSD CONF BACKUP / RESTORE. Press **[Enter]**, then press **[Y]** to invoke *OSD Config Backup / Restore* mode.
3. Run the Firmware Management Utility. In the dialog box, choose *OSD Configuration Backup/Restore*, then click **[Next]**.
4. In the window that appears, click *Connect Device*.
5. In the Password field, key in a password for the file.
Note: *Setting a password is optional. If you do not set one, the file can be restored without specifying a password.*
6. Click Backup.
7. When the browser asks what you want to do with the file, select *Save to disk*, then save it in a convenient location.

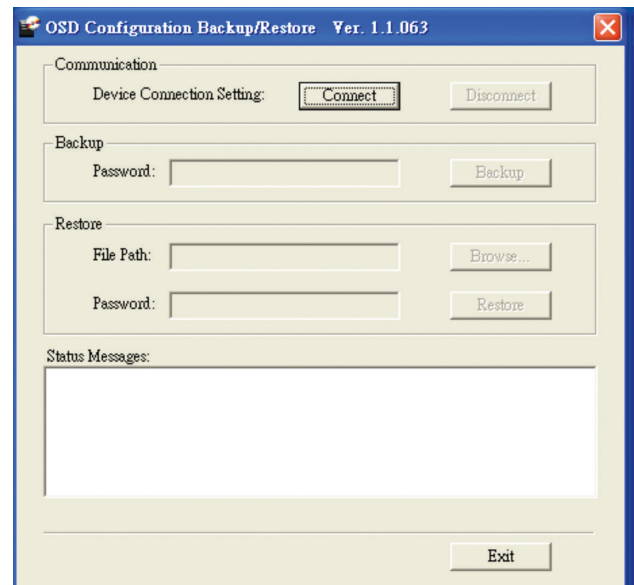

13. Firmware Management Utility

13.7.2 Restore

Follow these steps to restore a backup file from a local computer:

1. Perform steps 1 to 3 of section **13.7.1 Backup**.
2. Click Restore to recover an OSD configuration stored in the local computer. If you have previously set a password for this feature, enter the password in the provided field before clicking Restore. A confirmation window appears; click Yes to proceed.
3. Browse for the OSD configuration file you want to use and click Restore. Make sure the backup file is in the local computer.
4. A confirmation window appears when the restore process is done and successful. Click OK to close it.

14. Appendix

14.1 Factory Default Hot Keys and Settings

| Setting | Hot Key | Default |
|-----------------------------------|-------------|-----------------------------|
| OSD Hot Key (Default / Alternate) | [T] | [Scroll Lock] [Scroll Lock] |
| Invoking HSM | [H] | [Num Lock] [-] |
| Auto Scan Interval | [A] [Enter] | 5 seconds |
| Mouse Emulation | [M] | Enabled |
| Port Switching Keys (on / Off) | [X] [Enter] | Enabled |
| Beeper | [B] | Enabled |

14.2 Specifications

| Model | | B024-HU08 | B024-HU16 | |
|----------------------|------------------------|---|---|---------------------------------------|
| Computer Connections | Direct | 8 | 16 | |
| | Max. | 512 (via cascade) | 256 (via cascade) | |
| Port Selection | | OSD, Hot Key, Pushbutton | | |
| Connectors | Console Ports | KB | 1 x USB Type-A, Female (Black) | |
| | | Video | 1 x HDMI, Female | |
| | | Mouse | 1 x USB Type-A, Female (Black) | |
| | | Speakers | 2 x Mini Stereo Jack F (Green; 1 x front panel, 1 x rear panel) | |
| | KVM Ports | KB / Mouse | 8 x USB Type-B, Female (White) | 16 x USB Type-B, Female (White) |
| | | Video | 8 x HDMI, Female (White) | 16 x HDMI, Female (White) |
| | | Speakers | 8 x Mini Stereo Jack, Female (Green) | 16 x Mini Stereo Jack, Female (Green) |
| | F/W Upgrade | | 1 x RJ11, Female (Black) | |
| | Power | | 1 x DC Jack | |
| | USB 2.0 Hub | | 2 x USB Type-A, Female (White) (1 x front panel, 1 x rear panel) | |
| Switches | Port Selection | 8 x Pushbutton | 16 x Pushbutton | |
| | Reset | 1 x Semi-Recessed Pushbutton | | |
| | F/W Upgrade | 1 x Slide Switch | | |
| LEDs | USB Link | 8 (Green) | 16 (Green) | |
| | On Line / Selected | 8 (Orange) | 16 (Orange) | |
| | Power | 1 (Dark Green) | | |
| Emulation | Keyboard / Mouse | USB | | |
| Video | | 480i, 480p, 720p, 1080i, 1080p (HDTV) / 1920 x 1200 @ 60 Hz | | |
| Scan Interval | | 1-255 Seconds (Default: 5 seconds) | | |
| Power Consumption | | DC 5.0V, 12.0W | DC 5.0V, 12.2W | |
| Environment | Operating Temp. | 32°F - 122°F (0°C - 50°C) | | |
| | Storage Temp. | -4°F - 140°F (-20°C - 60°C) | | |
| | Humidity | 0-80% RH, Non-Condensing | | |
| Physical Properties | Housing | Metal | | |
| | Weight | 7.7 lb. (3.5 kg) | 8.5 lb. (3.9 kg) | |
| | Dimensions [H x W x D] | 1.7 x 10.1 x 17.2 in. (44 x 256.6 x 437.2 mm) | | |

15. Warranty & Product Registration

2-YEAR LIMITED WARRANTY

TRIPP LITE warrants its products to be free from defects in materials and workmanship for a period of two (2) years from the date of initial purchase. TRIPP LITE's obligation under this warranty is limited to repairing or replacing (at its sole option) any such defective products. To obtain service under this warranty, you must obtain a Returned Material Authorization (RMA) number from TRIPP LITE or an authorized TRIPP LITE service center. Products must be returned to TRIPP LITE or an authorized TRIPP LITE service center with transportation charges prepaid and must be accompanied by a brief description of the problem encountered and proof of date and place of purchase. This warranty does not apply to equipment, which has been damaged by accident, negligence or misapplication or has been altered or modified in any way.

EXCEPT AS PROVIDED HEREIN, TRIPP LITE MAKES NO WARRANTIES, EXPRESS OR IMPLIED, INCLUDING WARRANTIES OF MERCHANTABILITY AND FITNESS FOR A PARTICULAR PURPOSE.

Some states do not permit limitation or exclusion of implied warranties; therefore, the aforesaid limitation(s) or exclusion(s) may not apply to the purchaser.

EXCEPT AS PROVIDED ABOVE, IN NO EVENT WILL TRIPP LITE BE LIABLE FOR DIRECT, INDIRECT, SPECIAL, INCIDENTAL OR CONSEQUENTIAL DAMAGES ARISING OUT OF THE USE OF THIS PRODUCT, EVEN IF ADVISED OF THE POSSIBILITY OF SUCH DAMAGE. Specifically, TRIPP LITE is not liable for any costs, such as lost profits or revenue, loss of equipment, loss of use of equipment, loss of software, loss of data, costs of substitutes, claims by third parties, or otherwise.

PRODUCT REGISTRATION

Visit triplite.com/warranty today to register your new Tripp Lite product. You'll be automatically entered into a drawing for a chance to win a FREE Tripp Lite product!*

* No purchase necessary. Void where prohibited. Some restrictions apply. See website for details.

FCC Notice, Class A

This device complies with part 15 of the FCC Rules. Operation is subject to the following two conditions: (1) This device may not cause harmful interference, and (2) this device must accept any interference received, including interference that may cause undesired operation.

Note: This equipment has been tested and found to comply with the limits for a Class A digital device, pursuant to part 15 of the FCC Rules. These limits are designed to provide reasonable protection against harmful interference when the equipment is operated in a commercial environment. This equipment generates, uses, and can radiate radio frequency energy and, if not installed and used in accordance with the instruction manual, may cause harmful interference to radio communications. Operation of this equipment in a residential area is likely to cause harmful interference in which case the user will be required to correct the interference at his own expense. The user must use shielded cables and connectors with this equipment. Any changes or modifications to this equipment not expressly approved by Tripp Lite could void the user's authority to operate this equipment.

WEEE Compliance Information for Tripp Lite Customers and Recyclers (European Union)



Under the Waste Electrical and Electronic Equipment (WEEE) Directive and implementing regulations, when customers buy new electrical and electronic equipment from Tripp Lite they are entitled to:

- Send old equipment for recycling on a one-on-one, like-for-like basis (this varies depending on the country)
- Send the new equipment back for recycling when this ultimately becomes waste.

Use of this equipment in life support applications where failure of this equipment can reasonably be expected to cause the failure of life support equipment or to significantly affect its safety or effectiveness is not recommended.

Tripp Lite has a policy of continuous improvement. Specifications are subject to change without notice. Photos and illustrations may differ slightly from actual products.



1111 W. 35th Street, Chicago, IL 60609 USA • triplite.com/support