

HIKVISION®

ColorVu

**5 MP TurboHD™
Bullet and Turret
Cameras**

User Manual

122919NA

DS-2CE10HFT-F • DS-2CE10HFT-F28
DS-2CE12HFT-F • DS-2CE12HFT-F28
DS-2CE72HFT-F • DS-2CE72HFT-F28

Contents

User Manual	3
Regulatory Information	3
FCC Information	3
FCC Compliance	3
FCC Conditions	3
EU Conformity Statement	3
Industry Canada ICES-003 Compliance	4
Warning	4
Safety Instruction	4
Warnings	4
Cautions	5
Mark Description	5
1 Introduction	6
1.1 Product Features	6
1.2 Overview	6
1.2.1 Overview of Type I Camera	6
1.2.2 Overview of Type II Camera	6
1.2.3 Overview of Type III Camera	6
2 Installation	7
2.1 Installation of Type I Camera	7
2.1.1 Ceiling/Wall Mounting without Junction Box	7
2.1.2 Ceiling/Wall Mounting with Junction Box	8
2.2 Installation of Type II Camera	9
2.2.1 Ceiling/Wall Mounting without Junction Box	9
2.3 Installation of Type III Camera	11
2.3.1 Ceiling/Wall Mounting without Junction Box	11
2.4 Ceiling/Wall Mounting with Junction Box	12
3 Menu Description	14
3.1 VIDEO FORMAT	16
3.2 EXPOSURE	16
3.2.1 EXPOSURE MODE	16
3.2.2 AGC (Auto Gain Control)	16
3.2.3 SLOW SHUTTER	16
3.2.4 ANTI-BANDING	16
3.3 VIDEO SETTINGS	17
3.3.1 IMAGE MODE	17
3.3.2 WHITE BALANCE	17
3.3.3 BRIGHTNESS	17
3.3.4 CONTRAST	17
3.3.5 SHARPNESS	17
3.3.6 SATURATION	18
3.3.7 3 DNR (3D DNR)	18
3.3.8 MIRROR	18
3.4 SMART LIGHT	18
3.5 FUNCTIONS	18
3.5.1 MOTION DET	18
3.5.2 PRIVACY	18
3.6 FACTORY DEFAULT	18
3.7 EXIT	19
3.8 SAVE & EXIT	19

User Manual

Thank you for purchasing our product. If there are any questions or requests, please contact your dealer.

This manual applies to the models below:

Type	Model
Type I Camera	DS-2CE10HFT-F
	DS-2CE10HFT-F28
Type II Camera	DS-2CE12HFT-F
	DS-2CE12HFT-F28
Type III Camera	DS-2CE72HFT-F
	DS-2CE72HFT-F28

This manual may contain technical mistakes or printing errors, and the content is subject to change without notice. Updates will be added to new versions of this manual. We will readily improve or update the products or procedures described in the manual.

Regulatory Information

FCC Information

Please take attention that changes or modification not expressly approved by the party responsible for compliance could void the user's authority to operate the equipment.

FCC Compliance

This equipment has been tested and found to comply with the limits for a Class A digital device, pursuant to part 15 of the FCC Rules. These limits are designed to provide reasonable protection against harmful interference when the equipment is operated in a commercial environment. This equipment generates, uses, and can radiate radio frequency energy and, if not installed and used in accordance with the instruction manual, may cause harmful interference to radio communications. Operation of this equipment in a residential area is likely to cause harmful interference, in which case the user will be required to correct the interference at his own expense.

FCC Conditions

This device complies with part 15 of the FCC Rules. Operation is subject to the following two conditions:

1. This device may not cause harmful interference.
2. This device must accept any interference received, including interference that may cause undesired operation.

EU Conformity Statement

 This product and, if applicable, the supplied accessories too are marked with "CE" and comply therefore with the applicable harmonized European standards listed under the Low

Voltage Directive 2014/35/EU, the EMC Directive 2014/30/EU, the RoHS Directive 2011/65/EU.



2012/19/EU (WEEE Directive): Products marked with this symbol cannot be disposed of as unsorted municipal waste in the European Union. For proper recycling, return this product to your local supplier upon the purchase of equivalent new equipment, or dispose of it at designated collection points. For more information see: www.recyclethis.info.



2006/66/EC (Battery Directive): This product contains a battery that cannot be disposed of as unsorted municipal waste in the European Union. See the product documentation for specific battery information. The battery is marked with this symbol, which may include lettering to indicate cadmium (Cd), lead (Pb), or mercury (Hg). For proper recycling, return the battery to your supplier or to a designated collection point. For more information, see: www.recyclethis.info.

Industry Canada ICES-003 Compliance

This device meets the CAN ICES-3 (A)/NMB-3(A) standards requirements.

Warning

This is a class A product. In a domestic environment this product may cause radio interference, in which case the user may be required to take adequate measures.

Safety Instruction

These instructions are intended to ensure that the user can use the product correctly to avoid danger or property loss.

The precaution measures are divided into "Warnings" and "Cautions."

Warnings: Serious injury or death may occur if any of the warnings are neglected.

Cautions: Injury or equipment damage may occur if any of the cautions are neglected.



Warnings Follow these safeguards to prevent serious injury or death.



Cautions Follow these precautions to prevent potential injury or material damage.



Warnings

In the use of the device, you must be in strict compliance with the electrical safety regulations of the nation and region.

Input voltage should meet both the SELV (Safety Extra Low Voltage) and the Limited Power Source with 12 VDC according to the IEC60950-1 standard. Refer to technical specifications for detailed information.

Do not connect multiple devices to one power adapter to avoid overheating or a fire hazard caused by overload.

Make sure that the plug is firmly connected to the power socket.

Make sure that the device is firmly fixed if wall mounting or ceiling mounting is used.

If smoke, odor, or noise rise from the device, turn off the power at once, unplug the power cord, and contact the service center.

Untrained personnel should never attempt to disassemble the camera.



Cautions

Do not drop the camera or subject it to physical shock.

Do not touch sensor modules with fingers.

Do not place the camera in extremely hot, cold (the operating temperature shall be -40° to 60° C), dusty, or damp locations, and do not expose it to high electromagnetic radiation.

If cleaning is necessary, use a clean cloth with a bit of ethanol, and wipe it gently.

Do not aim the camera at the sun or extra bright places.

The sensor may burn out by a laser beam, so if any laser equipment is in use, make sure that the surface of the sensor will not be exposed to the laser beam.

Do not expose the device to high electromagnetic radiation or an extremely hot, cold, dusty, or damp environment.

To avoid heat accumulation, good ventilation is required for the operating environment.

Keep the camera away from liquid while in use for non-waterproof device.

While in delivery, the camera shall be packed in its original, or similar, packing.

Mark Description

Table 0-1 Mark Description

Mark	Description
---	DC Voltage

1 Introduction

1.1 Product Features

The main features are as follows:

- High performance CMOS sensor
- OSD menu with configurable parameters
- 24-hour color image
- Smart light
- 3-axis adjustment

1.2 Overview

1.2.1 Overview of Type I Camera

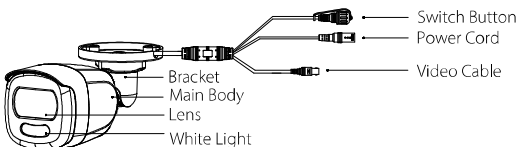

Figure 1, Type I Camera Overview

NOTE: Press and hold the switch button for five seconds to switch the video output. Four kinds of video outputs are available: TVI, AHD, CVI, and CVBS.

1.2.2 Overview of Type II Camera

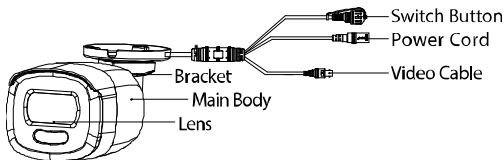

Figure 2, Type II Camera Overview

NOTE: Press and hold the switch button for five seconds to switch the video output. Four kinds of video outputs are available: TVI, AHD, CVI, and CVBS.

1.2.3 Overview of Type III Camera

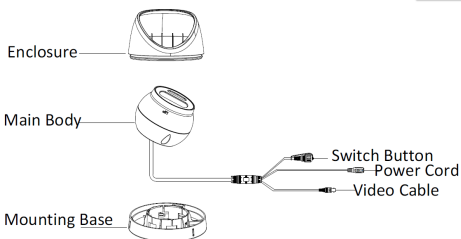

Figure 3, Type III Camera Overview

NOTE: Press and hold the switch button for five seconds to switch the video output. Four kinds of video outputs are available: TVI, AHD, CVI, and CVBS.

2 Installation

Before You Start

- Make sure that the device in the package is in good condition and all assembly parts are included.
- Make sure that all related equipment is powered off during the installation.
- Check the products' specifications for the installation environment.
- Check whether the power supply matches your power output to avoid damage.
- Make sure the wall is strong enough to withstand three times the weight of the camera and the mount.
- If the wall is concrete, insert expansion bolts before installing the camera. If the wall is wood, use self-tapping screws to secure the camera.
- If the product does not function properly, contact your dealer or the nearest service center. Do NOT disassemble the camera for repair or maintenance yourself.

2.1 Installation of Type I Camera

2.1.1 Ceiling/Wall Mounting without Junction Box

Before You Start

Ceiling mounting and wall mounting are similar. The following uses ceiling mounting as an example.

1. Paste the drill template (supplied) where you want to install the camera.
2. Drill screw holes and the cable hole (optional) on the ceiling according to the drill template.

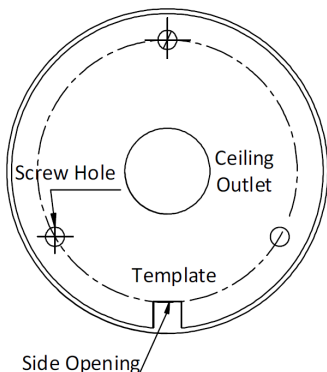

Figure 4, Drill Template

NOTE: Drill a cable hole when using the ceiling outlet to route the cable.

3. Route the cables through the cable hole or the side opening.

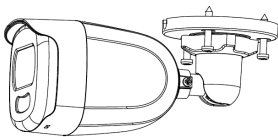

Figure 5, Secure the Camera to the Ceiling

4. Attach the bracket to the ceiling, and secure the camera with supplied screws.

NOTES: The supplied screw package contains self-tapping screws and expansion bolts.

For a concrete wall/ceiling, expansion bolts are required to fix the camera. For a wood wall/ceiling, self-tapping screws are required.

5. Connect the power cord and video cable.
6. Power on the camera to check if the image on the monitor is at an optimum angle. If not, loosen the bracket adjusting nut to modify the position.

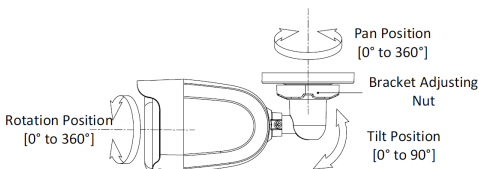

Figure 6, 3-Axis Adjustment

2.1.2 Ceiling/Wall Mounting with Junction Box

Before You Start

You need to purchase a junction box in advance.

1. Paste the drill template (supplied) on the ceiling/wall.
2. Drill screw holes and the cable hole on the ceiling according to the drill template.

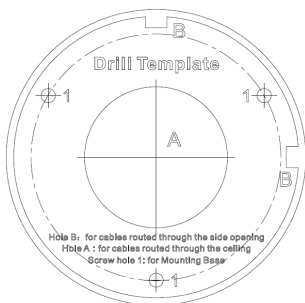

Figure 7, Drill Template of Junction Box

3. Take apart the junction box, and align the camera screw holes with those on the junction box cover.
4. Attach the camera to the junction box cover with supplied screws.

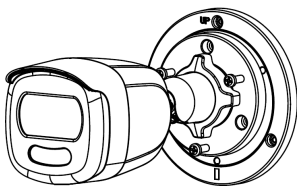

Figure 8, Attach Camera to Junction Box Cover

5. Secure the junction box body on the ceiling/wall with supplied screws.

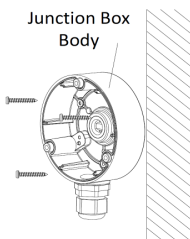

Figure 9, Secure Junction Box on Wall/Ceiling

6. Route the cables through the junction box's bottom cable hole or side cable hole.
7. Attach the junction box cover to its body.

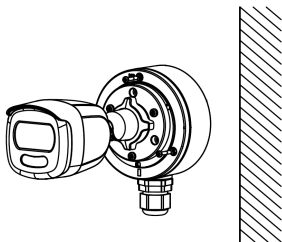

Figure 10, Re-attach Junction Box Cover to its Body

8. Repeat steps 5 and 6 of *2.1.1 Ceiling/Wall Mounting without Junction Box* to finish the installation.

2.2 Installation of Type II Camera

2.2.1 Ceiling/Wall Mounting without Junction Box

Before You Start

Ceiling mounting and wall mounting are similar. The following uses ceiling mounting as an example.

NOTE: Installation with a junction box refers to *2.1.2 Ceiling/Wall Mounting with Junction Box*.

1. Paste the drill template (supplied) where you want to install the camera.

2. Drill the screw holes and the cable hole (optional) on the ceiling according to the drill template.

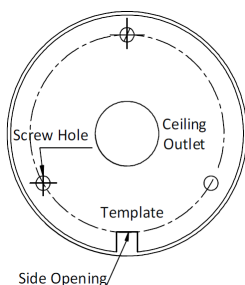

Figure 11, Drill Template

- NOTE:** Drill a cable hole when using the ceiling outlet to route the cable.
3. Route the cables through the cable hole or the side opening.
 4. Attach the bracket to the ceiling, and secure the camera with supplied screws.

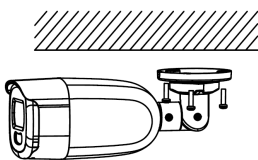

Figure 12, Secure the Camera to the Ceiling

- NOTE:** The supplied screw package contains self-tapping screws and expansion bolts.

For a concrete wall/ceiling, expansion bolts are required to fix the camera. For a wooden wall/ceiling, self-tapping screws are required.

5. Connect the corresponding power cord and video cable.
6. Power on the camera to check whether the image on the monitor is at an optimum angle. If not, adjust the camera according to the figure below.

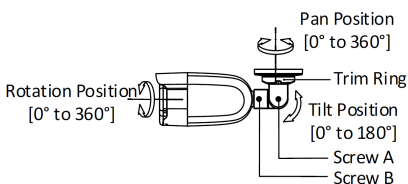

Figure 13, 3-Axis Adjustment

- 1) Loosen trim ring to adjust pan position [0° to 360°].
- 2) Loosen screw A to adjust tilt position [0° to 180°].
- 3) Loosen screw B to adjust rotation position [0° to 360°].

2.3 Installation of Type III Camera

2.3.1 Ceiling/Wall Mounting without Junction Box

Before You Start

Ceiling mounting and wall mounting are similar. The following uses ceiling mounting as an example.

1. Disassemble the camera by rotating it to align the notch to one of the lines, as shown below.

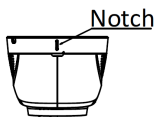

Figure 14, Disassemble the Camera

2. Pry the mounting base open with a flat object (for example, a coin).

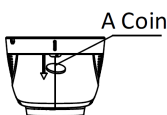

Figure 15, Pry the Mounting Base

3. Paste the drill template (supplied) to where you want to install the camera.
4. Drill the screw holes and the cable hole (optional) according to the drill template.

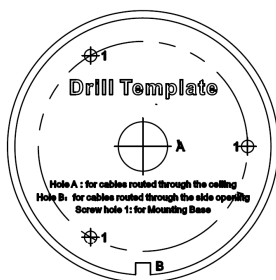

Figure 16, Drill Template

NOTE: Drill a cable hole when using the ceiling outlet to route the cable.

5. Attach the mounting base to the ceiling, and secure it with supplied screws. For a concrete ceiling, you need to install the expansion bolts first.

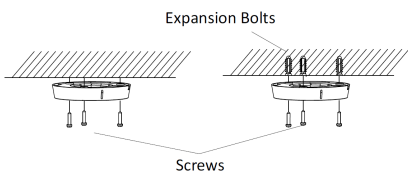

Figure 17, Attach Mounting Base to Ceiling

NOTE: The supplied screw package contains self-tapping screws and expansion bolts.

6. Route the cables through the cable hole or side opening.
7. Re-install and secure camera to the mounting base.

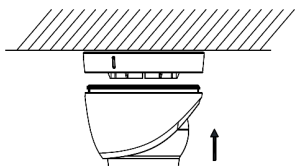

Figure 18, Install the Camera Back

8. Connect the corresponding cables such as power cord and video cable.
9. Power on the camera to check if the image on the monitor is at an optimum angle. If not, adjust the camera according to the figure below to get an optimum angle.

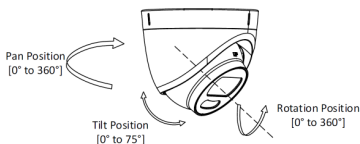

Figure 19, 3-Axis Adjustment

- 1) Rotate the enclosure to adjust the pan position [0° to 360°].
- 2) Move the camera body up and down to adjust the tilt position [0° to 75°].
- 3) Rotate the main body to adjust the rotation position [0° to 360°].

2.4 Ceiling/Wall Mounting with Junction Box

Before You Start

You need to purchase a junction box in advance. Ceiling mounting and wall mounting are similar. The following uses wall mounting as an example.

1. Paste the drill template on the wall.
2. Drill screw holes and cable hole (optional) according to the drill template.

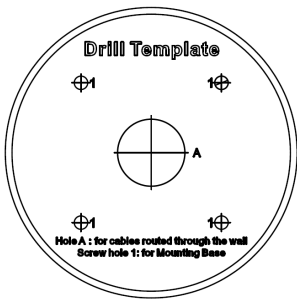

Figure 20, Drill Template

NOTE: Drill a cable hole when using a ceiling outlet to route the cable.

3. Take apart the junction box, and align the mounting base screw holes with those on the junction box cover.
4. Install the mounting base to the junction box cover with three PM4 screws.

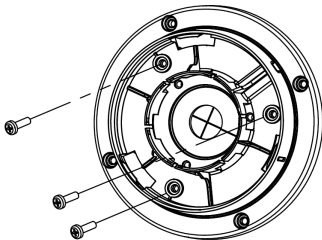

Figure 21, Secure Junction Box Cover Screws

5. Secure the junction box's body on the wall with four PA4 × 25 screws.

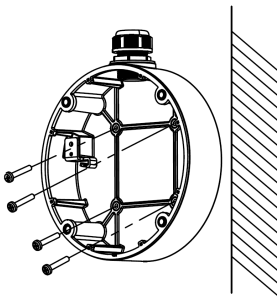

Figure 22, Secure Junction Box Body

6. Route the cables through the junction box's bottom or side cable hole.
7. Attach the junction box cover to its body.
8. Repeat steps 7 to 9 of *2.3.1 Ceiling/Wall Mounting without Junction Box* to finish the installation.

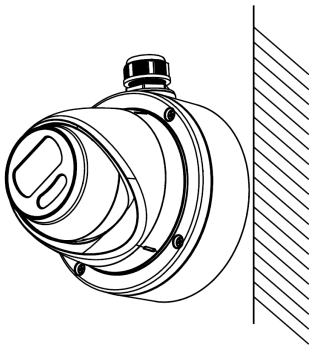

Figure 23, Finish the Installation

3 Menu Description

Follow the steps below to call the menu.

NOTE: The actual display may vary by camera model.

1. Connect the camera to the TVI DVR and the monitor, as shown below.

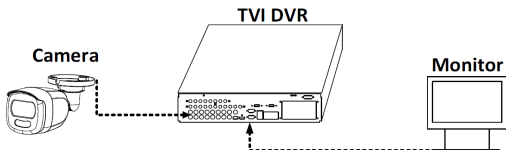



Figure 24, Connection

2. Power on the camera, TVI DVR, and the monitor to view the image on the monitor.
3. Click **PTZ Control** to enter the PTZ Control interface.
4. Call the camera menu by clicking the  button or call preset No. 95.

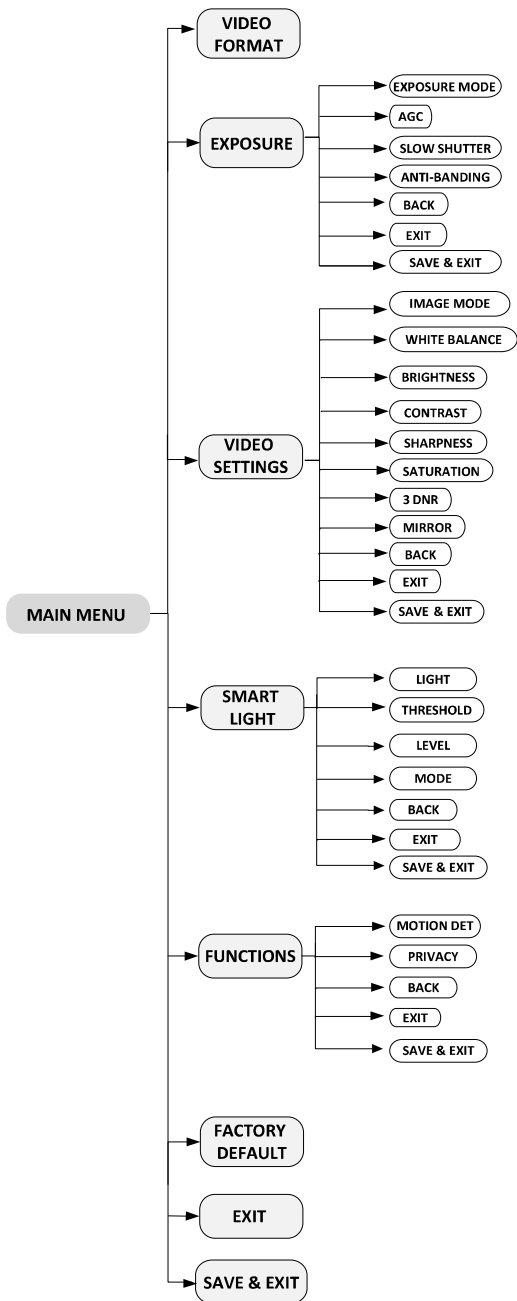

Figure 25, Main Menu Overview

5. Click the direction arrow to control the camera.
 - 1) Click up/down button to select the item.
 - 2) Click Iris + to confirm the selection.
 - 3) Click left/right button to adjust selected value.

3.1 VIDEO FORMAT

You can set the video format to 5 MP @ 20 fps, 4 MP @ 30 fps, 4 MP @ 25 fps, 2 MP @ 30 fps, or 2 MP @ 25 fps.

3.2 EXPOSURE

3.2.1 EXPOSURE MODE

You can set the **EXPOSURE MODE** to **GLOBAL**, **BLC**, **HLC**, **WDR**, or **HLS**.

- **GLOBAL**

GLOBAL refers to the normal exposure mode, which adjusts lighting distribution, variations, and non-standard processing.

- **BLC (Backlight Compensation)**

BLC (Backlight Compensation) compensates light to the object in the front to make it clear, but this may cause overexposure of the background where the light is strong.

- **HLC (Highlight Compensation)**

HLC stands for highlight compensation. The camera detects strong spots (overexposed portions of image), then reduces the brightness of the strong spots to improve the overall image.

- **WDR (Wide Dynamic Range)**

The wide dynamic range (**WDR**) function helps the camera provide clear images even under backlight circumstances. When there are both very bright and very dark areas simultaneously in the field of view, **WDR** balances the brightness level of the whole image and provides clear images with details.

- **HLS (Highlight Suppression)**

This is the same visual effect as a solar eclipse. If the brightness of a part in the image exceeds the threshold, this part will become black. Then the whole image will be clear.

3.2.2 AGC (Auto Gain Control)

Optimizes image clarity in poor light conditions. The **AGC** level can be set to **HIGH**, **MEDIUM**, or **LOW**.

NOTE: Noise will be amplified when setting AGC level.

3.2.3 SLOW SHUTTER

SLOW SHUTTER increases the exposure time on a single frame, which makes a camera more sensitive to the light so it can produce images even in low lux conditions.

3.2.4 ANTI-BANDING

ANTI-BANDING prevents the appearance of horizontal lines (banding) when photographing images in low frequency light and high brightness environments.

3.3 VIDEO SETTINGS

Move the cursor to **VIDEO SETTINGS** and click **Iris+** to enter the submenu. **IMAGE MODE**, **WHITE BALANCE**, **BRIGHTNESS**, **CONTRAST**, **SHARPNESS**, **SATURATION**, **3DNR**, and **MIRROR** are adjustable.

VIDEO SETTINGS	
IMAGE MODE	◀ STD ▶
WHITE BALANCE	↵
BRIGHTNESS	◀ 5 ▶
CONTRAST	◀ 5 ▶
SHARPNESS	◀ 5 ▶
SATURATION	◀ 5 ▶
3DNR	◀ 5 ▶
MIRROR	◀ OFF ▶
BACK	↵
EXIT	↵
SAVE & EXIT	↵

Figure 26, Video Settings

3.3.1 IMAGE MODE

IMAGE MODE adjusts the image saturation. You can set it to **STD** (Standard) or **HIGH-SAT** (High Saturation).

3.3.2 WHITE BALANCE

White balance, the camera's white rendition function, adjusts the color temperature according to the environment. It can remove unrealistic color casts in the image. You can set **WHITE BALANCE** mode to **AUTO** or **MANUAL**.

- **AUTO**—White balance is adjusted automatically based on the scene illumination color temperature.
- **MANUAL**—You can set the R-GAIN/B-GAIN value to adjust the image's red/blue color shades.

WHITE BALANCE	
MODE	◀ MANUAL ▶
R-GAIN	◀ 5 ▶
B-GAIN	◀ 5 ▶
BACK	↵
EXIT	↵
SAVE&EXIT	↵

Figure 27, MWB MODE

3.3.3 BRIGHTNESS

Brightness refers to the image brightness. You can set the brightness value from 1 to 9 to darken or brighten the image. The greater the value, the brighter the image.

3.3.4 CONTRAST

This feature enhances the difference in color and light between parts of an image.

3.3.5 SHARPNESS

Sharpness determines the amount of detail an imaging system can reproduce.

3.3.6 SATURATION

Saturation is the proportion of pure chromatic color in the total color sensation. Adjust this feature to change the color intensity.

3.3.7 3 DNR (3D DNR)

3 DNR refers to 3D digital noise reduction. Compared to general 2D digital noise reduction, 3D digital noise reduction processes the noise between two frames in addition to processing the noise in one frame. The noise will be much less and the video will be clearer.

3.3.8 MIRROR

OFF, H, V, and HV are selectable for mirror.

- **OFF:** The mirror function is disabled
- **H:** The image flips 180° horizontally
- **V:** The image flips 180° vertically
- **HV:** The image flips 180° both horizontally and vertically

3.4 SMART LIGHT

Under the **SMART LIGHT** sub-menu, you can set the mode to **OFF** or **AUTO**.

- **OFF**—Set it to **OFF** to give up this function.
- **AUTO**—You can set **THRESHOLD** and **LEVEL** in this section.

SMART LIGHT	
LIGHT	◀ AUTO ▶
THRESHOLD	◀ 2 ▶
LEVEL	◀ 5 ▶
MODE	MODE1
BACK	←
EXIT	←
SAVE & EXIT	←

Figure 28, SMART LIGHT

3.5 FUNCTIONS

3.5.1 MOTION DET

MOTION DET refers to motion detection. With the motion detection feature, motion can be detected in any part of a camera's view. You can configure full screen or a number of zones in a camera's view where motion is to be detected.

3.5.2 PRIVACY

This function allows you to block or mask certain area of a scene for personal privacy by preventing recording or live viewing. You can turn on/off **PRIVACY** to meet your needs.

3.6 FACTORY DEFAULT

Resets all settings to the factory defaults.

3.7 EXIT

Move the cursor to **EXIT** and click **Iris+** to exit the menu.

3.8 SAVE & EXIT

Move the cursor to **SAVE & EXIT** and click **Iris+** to save the settings and exit the menu.