

## EKT-KxxT2x Series

### 2 MP Value Express TurboHD Kits

#### Cameras

- 2 MP High Performance CMOS
- Up to 1920 x 1080 Resolution
- 2.8 mm Fixed Lens
- EXIR 2.0 with up to 65 ft (20 m) IR Range
- Smart IR
- Digital WDR, BLC
- IP66 Protection



**EKT-K41T24:** (4) 2 MP TurboHD Cameras • (1) 4-Channel DVR w/1 TB HDD

#### DVR

- Up to 4 MP Resolution Recording
- Up to 6 or 12-ch 6 MP IP Cameras Input
- H.265+ / H.265 / H.264+ / H.264
- 4- or 8-ch Synchronous Playback
- 1 SATA Interface (up to 10 TB Capacity per HDD)



**EKT-K82T26:** (6) 2 MP TurboHD Cameras • (1) 8-Channel DVR w/2 TB HDD

Hikvision EKT-KxxT2x Series 2 MP Value Express Kits are cost-effective solutions for value-oriented users.

Each kit is supplied with four or six network cameras with 2 MP image sensors and a 4-, or 8-channel DVR in the same box.

Kit DVRs are pre-installed with a 1 or 2 TB HDD.

#### Available models:

##### EKT-K41T24

(1) ERT-K2041 DVR (1 TB HDD) + (4) TurboHD ECT-T12F2 Cameras

##### EKT-K82T26

(1) ERT-K2082 DVR (2 TB HDD) + (6) TurboHD ECT-T12F2 Cameras



# Specifications

EKT-K41T24		EKT-K82T26
<b>CAMERA</b>		
Camera Model	ECT-T12F2	
Number of Cameras	4	6
Image Sensor	2 MP CMOS image sensor	
Signal System	NTSC	
Effective Pixels	1920 (H) × 1080 (V)	
Minimum Illumination	0.01 lux @ (f/1.2, AGC on), 0 lux with IR	
Shutter Speed	1/25 (1/30) s to 1/50,000 s	
Lens	2.8 mm fixed lens	
Horizontal Field of View	103°	
Lens Mount	M12	
Day/Night	IR cut filter	
Angle Adjustment	Pan: 0° to 360°, tilt: 0° to 75°, rotation: 0° to 360°	
Synchronization	Internal synchronization	
Video Frame Rate	1080p @ 30 fps	
<b>Menu</b>		
AGC	High/medium/low/off	
D/N Mode	Auto/color/BW (black and white)	
BLC	Supported	
DWDR	Supported	
Language	English	
Functions	Brightness, sharpness, DNR, mirror, smart IR	
<b>Interface</b>		
Video Output	1 HD analog output	
Switch Button	TVI/AHD/CVI/CVBS	
<b>General</b>		
Operating Conditions	-40° to 140° F (-40° to 60° C), humidity: 90% or less (non-condensing)	
Power Supply	12 VDC ±25%	
Power Consumption	Maximum 4 W	
Protection Level	IP66	
Material	Metal	
IR Range	Up to 650 ft (20 m)	
Dimensions	Ø3.38" x 2.74" (Ø82.6 mm x 69.66 mm)	
Weight	~0.51 lbs (~230 g)	
<b>DVR</b>		
DVR Model	ERT-K2041	ERT-K2082
<b>Video/Audio Input</b>		
Video Compression	H.265 Pro+/H.265 Pro/H.265/H.264+/H.264	
Analog Video Input	4-ch	8-ch
TurboHD Input	4 MP, 3 MP: 1080p25, 1080p30, 720p25, 720p30, 720p50, 720p60	
AHD Input	4 MP, 1080p25, 1080p30, 720p25, 720p30	
HD-CVI Input	4 MP, 1080p25, 1080p30, 720p25, 720p30	
CVBS Input	PAL/NTSC	
IP Video Input	2-ch (up to 6-ch) up to 6 MP resolution	4-ch (up to 12-ch) up to 6 MP resolution
Audio Compression	G.711u	
Audio Input/Two-Way Audio	1-ch, RCA (2.0 Vp-p, 1K Ω)	
<b>Video/Audio Output</b>		
HDMI/VGA Output	1-ch, 1920 × 1080/60 Hz, 1280 × 1024/60 Hz, 1280 × 720/60 Hz, 1024 × 768/60 Hz	
Encoding Resolution	When 1080p Lite mode not enabled: 4 MP lite/1080p/720p/VGA/WD1/4CIF/CIF; When 1080p Lite mode enabled: 1080p lite/720p/VGA/WD1/4CIF/CIF	
Main Stream Frame Rate	1080p Lite Mode Not Enabled	4 MP stream access: 4 MP lite @ 15 fps; 1080p lite/720p/WD1/4CIF/VGA/CIF @ 25 fps (P)/30 fps (N) 1080p stream access: 1080p/720p @ 15 fps 720p stream access: 720p
	1080p Lite Mode Enabled	4 MP stream access: 4 MP lite @ 15 fps; 1080p lite/720p lite/WD1/4CIF/VGA/CIF @ 25 fps (P)/30 fps (N) 1080p stream access: 1080p lite/720p lite/WD1/4CIF/VGA/CIF @ 25 fps (P)/30 fps (N) 720p stream access: 720p/WD1/4CIF/VGA/CIF @ 25 fps (P)/30 fps (N)
Sub-Stream Frame Rate	WD1/4CIF/2CIF @ 12 fps; CIF/QVGA/QCIF @ 25 fps (P)/30 fps (N)	
Video Bit Rate	32 Kbps to 6 Mbps	
Audio Output	1-ch, RCA (linear, 1K Ω)	
Audio Bit Rate	64 Kbps	
Dual Stream	Supported	
Stream Type	Video, Video & Audio	
Synchronous Playback	4-ch	
<b>Network</b>		
Remote Connections	32	64
Network Protocols	TCP/IP, PPPoE, DHCP, Hik-Connect, DNS, DDNS, NTP, SADP, NFS, iSCSI, UPnP™, HTTPS, ONVIF	
<b>Hard Disk</b>		
SATA	1 SATA interface	
Capacity	Up to 10 TB capacity for each disk	
Hard Drive Size	1 TB	2 TB
<b>External Interface</b>		
Network Interface	1, RJ-45 10M/100M self-adaptive Ethernet interface	
USB Interface	Rear panel: 2 × USB 2.0	
<b>General</b>		
Power Supply	12 VDC	
Consumption (without HDD)	≤8 W	≤12 W
Working Temperature	+14° to +131° F (-10° to +55° C)	
Working Humidity	10% to 90% non-condensing	
Dimensions	10.2" × 8.7" × 1.8" (260 mm × 222 mm × 45 mm)	
Weight (without HDD)	≤2.2 lb (≤1 kg)	

## Dimensions

ECI-T12F2 Camera

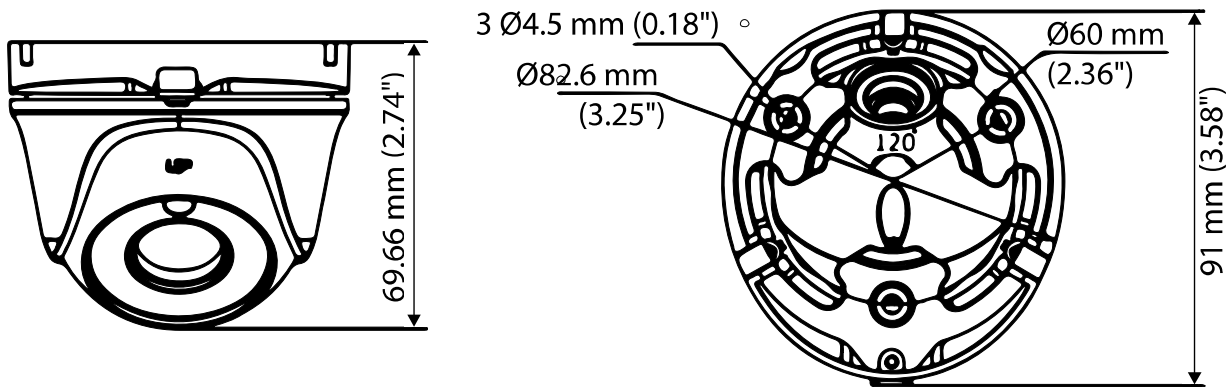

Unit: mm (inch)

## Interface

ERT-K2041 DVR Rear Panel

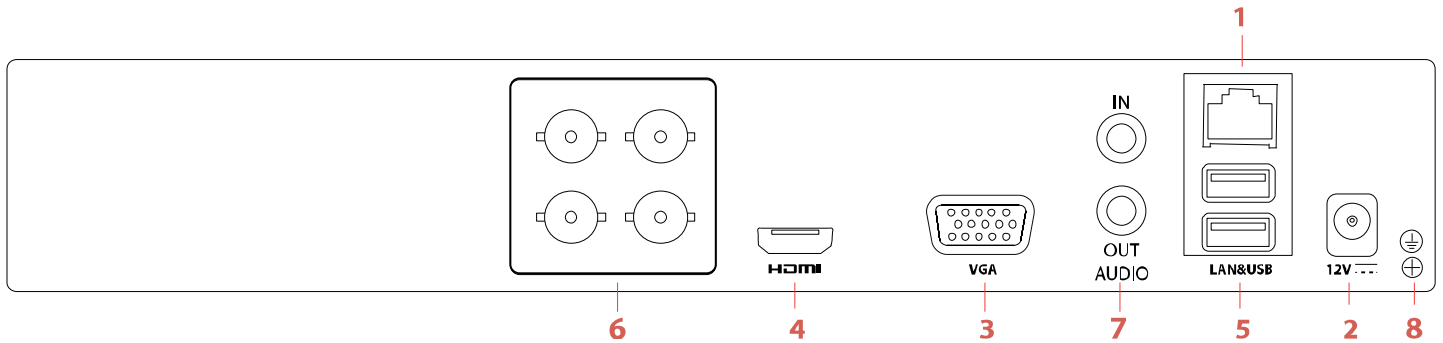



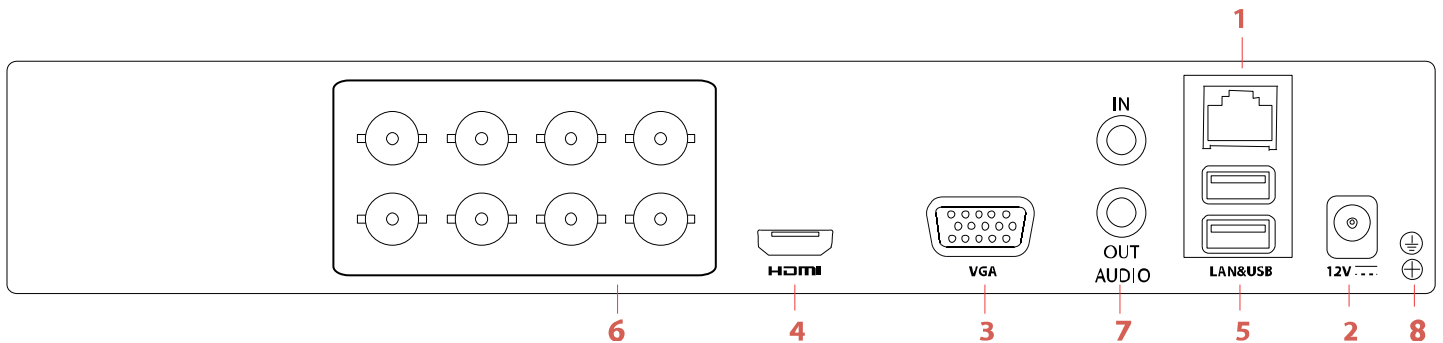

ERT-K2082 DVR Rear Panel



No.	Item	Description
1	LAN	Network connector
2	Power Supply	Input: 100 to 240 VAC, Output: 12 VDC
3	VGA	DB-15 connector for VGA output. Displays local video output and menu.
4	HDMI	HDMI video output connector
5	USB Interface	Universal Serial Bus port for additional devices
6	Analog Camera Inputs	BNC connectors for analog input
7	Audio In/Out	RCA connectors
8	Ground	Grounding screw

## Accessories (Not Included)

---

				
<b>PC110T</b> 110 mm Pendant Cap	<b>WMS</b> Short Wall Mount + Junction Box	<b>PM</b> Pole Mount Adapter	<b>CM</b> Corner Mount Adapter	<b>CBXS</b> Conduit Base

## Box Contents (Subject to Change without Notice)

---

Quick Start Guide (Camera)  
Quick Start Guide (DVR)  
Screws  
Mounting Template  
Power Pigtail with Power Leads  
Mouse  
Power Supply