



PRO-RT 2U Series UPS

User's Manual



Para Systems, Inc.
1455 Lemay Dr.
Carrollton, TX 75007
Phone: 1-972-446-7363
Fax: 1-972-446-9011
Internet: minutemanups.com
UPS Sizing: sizemyups.com

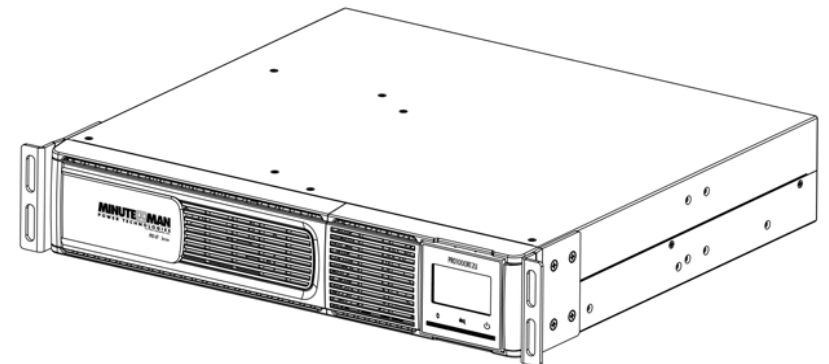



TABLE OF CONTENTS

| | | |
|------------|----------------------------------|-----------|
| 1. | Introduction | 2 |
| 2. | Controls and Indicators | 8 |
| 3. | Installation | 11 |
| 4. | Operation | 18 |
| 5. | Obtaining Service | 22 |
| 6. | Troubleshooting | 23 |
| 7. | Replacing the Battery | 24 |
| 8. | Specifications | 28 |
| 9. | Limited Product Warranty | 30 |
| A1. | Declaration of Conformity | 31 |

Chapter 1: Introduction

Thank you for purchasing this power protection product. It has been designed and manufactured to provide many years of trouble free service. Please read this manual before installing your PRO-RT2U Series UPS, models [PRO750RT2U](#), [PRO1000RT2U](#), [PRO1500RT2U](#), [PRO2000RT2U](#) as it provides important information that should be followed during the installation and the maintenance of the UPS system allowing you to correctly set up your system for the maximum safety and performance. Included is information on customer support and factory service, if it is required. If you experience a problem with the UPS system please refer to the Troubleshooting guide in this manual to correct the problem or collect enough information so that the Technical Support Department can assist you.

**IMPORTANT SAFETY INSTRUCTIONS
SAVE THESE INSTRUCTIONS !
CONSIGNES DE SÉCURITÉ IMPORTANTES
SAUVEGARDEZ CES CONSIGNES!**

Veuillez lire ce manuel avant l'installation de l'onduleur modèles [PRO750RT2U](#), [PRO1000RT2U](#), [PRO1500RT2U](#), [PRO2000RT2U](#). Il contient de l'information importante qui doit être respectée au cours de l'installation et de l'entretien de l'onduleur et des batteries. Cette information vous permettra de correctement installer le système pour atteindre son rendement maximum en toute sécurité.

CAUTION! The maximum ambient operating temperature for this UPS series is 40°C ("0 ~ 40°C" for Ambient Operation).

ATTENTION! La température ambiante de fonctionnement maximale pour cette série d'onduleurs est de 40° C ("0 ~ 40° C " pour une opération ambiante).

- The external vents and openings on the UPS are provided for ventilation. To ensure reliable operation of the UPS and to protect the UPS from overheating, these vents and openings must not be blocked or covered. Do not insert any object into any of the vents or openings that may hinder the ventilation.
- Install the UPS system in a well ventilated area, away from excess moisture, heat, dust, flammable gas or explosives.
- Leave adequate space (at least 20cm) at the front and rear of the UPS system for proper ventilation.
- Do not mount the UPS system with its front or rear panel facing down at any angle.
- Before usage, you must allow the UPS system to adjust to room temperature (20°C~25°C or 68°F~77°F) for at least one hour to avoid moisture condensing inside the UPS.

CAUTION! This UPS series is **ONLY** intended to be installed in an indoor temperature controlled environment that is free of conductive contaminants. This UPS series is not intended for use in a computer room as defined in the Standard for the Protection of Electronic Computer/Data Processing Equipment ANSI/NFPA 75.

ATTENTION! Cette série d'onduleurs est **uniquement** destinée à être installée dans un environnement intérieur à température contrôlée, exempt de contaminants conducteurs. La série d'onduleurs ne convient pas pour une utilisation en salle d'ordinateur comme défini dans la norme pour la Protection des ordinateurs électroniques/équipements de traitement de données, ANSI/NFPA 75.

CAUTION! Connect the UPS to a two pole, three wire, grounded, utility power AC wall outlet. The receptacle must be connected to the appropriate branch protection (circuit breaker or fuse). Connection to any other type of receptacle may result in a shock hazard and violate local electrical codes. Do not use extension cords, adapter plugs, or surge strips.

ATTENTION! Branchez l'UPS sur une prise murale c.a. de terre bipolaire à trois fils. La prise de courant doit être connectée au circuit de protection approprié (disjoncteur ou fusible). Une connexion à tout autre type de prise peut entraîner le risque d'électrocution et enfreindre les codes électriques locaux. N'utilisez jamais de rallonge, d'adaptateur ou de limiteur de surtension.

CAUTION! To reduce the risk of fire, connect only to a utility power circuit provided with 20 amperes maximum branch circuit over-current protection in accordance with the National Electric Code, ANSI/NFPA 70.

ATTENTION! Pour réduire les risques d'incendie, faites le raccordement uniquement sur un circuit d'alimentation électrique équipé d'un dispositif de protection de surintensité de circuit de dérivation de maximum 20 ampères, conformément au Code national de l'électricité, ANSI/NFPA 70.

CAUTION! To reduce the risk of electrical shock with the installation of this UPS equipment and the connected equipment, the user must ensure that the combined sum of the AC leakage current does not exceed 3.5mA.

ATTENTION! Pour réduire le risque de choc électrique pendant l'installation de cet onduleur et du matériel connecté, l'utilisateur doit s'assurer que la quantité de courant de fuite c.a. ne dépasse pas 3,5 mA.

CAUTION! To reduce the risk of electrical shock in conditions where the load equipment grounding cannot be verified, disconnect the UPS from the AC wall outlet before installing a computer interface cable. Reconnect the power cord only after all signaling connections are made.

ATTENTION! Pour réduire le risque de choc électrique dans une situation où il n'est pas possible de vérifier la mise à la terre du matériel de charge, il faut d'abord débrancher l'onduleur de la prise murale c.a. avant d'installer un câble d'interface ordinateur. Rebranchez le cordon d'alimentation uniquement après que toutes les connexions de signalisation aient été établies.

WARNING: This Uninterruptible Power Supply contains potentially hazardous voltages. Do not attempt to disassemble the UPS beyond the battery replacement procedure. This UPS contains no user serviceable parts. Repairs and battery replacement must be performed by **QUALIFIED SERVICE PERSONNEL ONLY**.

AVERTISSEMENT! Cet onduleur contient des tensions potentiellement dangereuses. N'essayez pas de le démonter au-delà de la procédure de remplacement de la batterie. L'onduleur ne contient aucune pièce réparable par l'utilisateur. **SEUL UN TECHNICIEN QUALIFIÉ** est autorisé à effectuer les réparations et le remplacement d'une batterie.

WARNING: Qualified Service Personnel ONLY must perform the Installation and Servicing of these UPS systems. MINUTEMAN accepts no liabilities and is not limited to: injury to the Service Personnel, or damages to; the UPS, or the connected equipment caused by the incorrect installation or servicing of the UPS system.

AVERTISSEMENT! Seul un technicien qualifié peut installer et entretenir ces systèmes UPS. MINUTEMAN n'accepte aucune responsabilité pour, sans s'y limiter : les blessures souffertes par le personnel de service ou les dommages infligés à l'onduleur ou au matériel connecté, résultant d'une mauvaise installation ou d'un entretien incorrect de l'onduleur.

WARNING: Risk of Electrical Shock. Hazardous live parts inside these power supplies are energized from the battery even when the AC input is disconnected.

AVERTISSEMENT! Risque de choc électrique. Les parties actives dangereuses à l'intérieur de ces blocs d'alimentation sont sous tension à partir de la batterie, même lorsque l'alimentation c.a. est coupée.

CAUTION! DO NOT USE THE MOUNTING BRACKETS TO LIFT THE UPS. The mounting brackets are **ONLY** for securing the UPS to the rack.

ATTENTION! N'UTILISEZ JAMAIS LES SUPPORTS DE MONTAGE POUR SOULEVER L'ONDULEUR. Ces supports sont **uniquement** conçus pour fixer l'onduleur au rack.

NOTE: These UPSs are shipped with the batteries disconnected. The batteries must be connected before putting these UPSs into service. Refer to Section 3 "Installation" for connecting the batteries.

To de-energize the outputs of the UPS:

1. If the UPS is on, press and release the On/Off/Test button during the audible alarm's first beep to turn the UPS off.
2. Disconnect the UPS from the AC wall outlet.
3. To de-energize the UPS completely, disconnect the battery.

ON / OFF / TEST BUTTON: When the UPS is connected to an AC source and there is an acceptable AC voltage present; Press and then release the On/Off/Test button during the audible alarm's first beep to turn the UPS on. UPS will provide an output and the load will be powered. Then the UPS will perform a five second self-test. Once the UPS has passed its self-test the UPS will be ready for normal operation.



When the UPS is in the AC mode; Press and then release the On/Off/Test button during the audible alarm's first beep to turn the UPS off.

To perform a ten-second self-test: With the UPS in the AC mode, press and hold the On/Off/Test button until the audible alarm sounds four beeps, and then release. During the test, the UPS will switch to the Battery mode, the On-Battery icon will illuminate and the audible alarm will sound.

NOTICE! The output of this device is not sinusoidal. It has a voltage total harmonic distortion and maximum single harmonic distortion as below:

| Model | PRO750RT2U | PRO1000RT2U | PRO1500RT2U | PRO2000RT2U |
|-----------------|------------|-------------|-------------|-------------|
| Total harmonic | 31.3% | 30.3% | 37.2% | 35.6% |
| Single harmonic | 14.5% | 14.9% | 18.7% | 15.7% |

NOTICE: This equipment has been tested and found to comply with the limits for a Class A and/or B computing device in accordance with the specifications in Subpart J of Part 15 of FCC Rules and the Class A and/or B limits for radio noise emissions from digital apparatus set out in the Radio Interference of the Canadian Department of Communications. These limits are designed to provide reasonable protection against such interference in a residential installation. This equipment generates and uses radio frequency and if not installed and used properly, that is, in strict accordance with the manufacturer's instructions, this equipment may cause interference to radio and television reception. If this equipment does cause interference to radio or television reception, which can be determined by turning the equipment off and on, the user is encouraged to try to correct the interference by one or more of the following measures:

- Re-orient the receiving antenna.
- Relocate the computer with respect to the receiver.
- Move the computer away from the receiver.
- Plug the computer into a different outlet so that the computer and receiver are on different branch circuits.
- Shielded communications interface cables must be used with this product.

Changes or modifications to this unit not expressly approved by the party responsible for compliance could void the user's authority to operate the equipment.

Receiving Inspection

After removing your UPS from its carton, it should be inspected for damage that may have occurred in shipping. Immediately notify the carrier and place of purchase if any damage is found. Warranty claims for damage caused by the carrier will not be honored. The packing materials that your UPS was shipped in are carefully designed to minimize any shipping damage. In the unlikely case that the UPS needs to be returned to the manufacturer, please use the original packing material. Since the manufacturer is not responsible for shipping damage incurred when the system is returned, the original packing material is inexpensive insurance. **PLEASE SAVE THE PACKING MATERIALS!**



Life Support Policy

As a general policy, we do not recommend the use of any of our products in life support applications where failure or malfunction of the product can be reasonably expected to cause failure of the life support device or to significantly affect its safety or effectiveness. We do not recommend the use of any of our products in direct patient care. We will not knowingly sell our products for use in such applications unless it receives in writing assurances satisfactory to us that (a) the risks of injury or damage have been minimized, (b) the customer assumes all such risks, and (c) our liability is adequately protected under the circumstances.

© COPYRIGHT 2018 BY PARA SYSTEMS, INC.

All Rights Reserved. All rights of this User Manual ("Manual"), including but not limited to the content, information, and figures are solely owned and reserved by Para Systems, Inc. ("Para Systems"). The Manual can only be applied to the operation or the use of this product. Any disposition, duplication, dissemination, reproduction, modification, translation, extraction, or usage of this Manual in whole or in part is prohibited without the prior written permission of Para Systems. Given that Para Systems will continuously improve and develop the product, changes may be made to the information in this Manual at any time without obligation to notify any person of such revision or changes. Para Systems will make all possible efforts to secure the accuracy and the integrity of this Manual. Para Systems disclaims any kinds or forms of warranty, guarantee, or undertaking, either expressly or implicitly, including but not limited to the completeness, faultlessness, accuracy, non-infringement, merchantability or fitness for a particular purpose of the Manual.

Chapter 2: Controls and Indicators

CONTROL PANEL

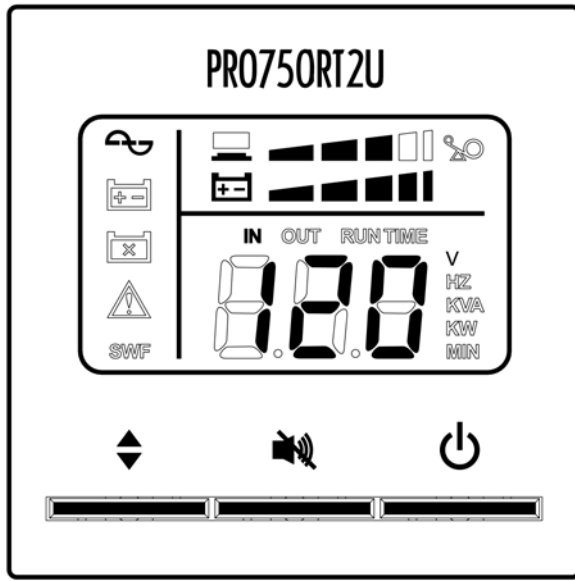

The AC mode icon illuminates when the UPS is on and operating in the AC mode. The AC mode icon will extinguish when operating in the Battery mode. The AC mode icon will blink when the UPS is operating in the AVR (Boost and Buck) mode.



The On-Battery icon illuminates when the UPS is operating in the Battery mode. The On-Battery icon will extinguish when operating in the AC mode.



The Weak/Bad Battery icon illuminates and the Weak/Bad Battery error code will be displayed when the UPS detects a weak battery, a bad battery or a disconnected battery. The Weak/Bad Battery icon is extinguished when the battery's condition is good.



The Fault icon illuminates and the appropriate error code will be displayed when the UPS detects an internal fault. The Fault icon is extinguished when the UPS is operating properly.



The Site Wiring icon illuminates and the Site Wiring Fault error code will be displayed when the UPS detects a site wiring problem. The SWF icon is extinguished when the UPS is connected to proper site wiring.



Load Capacity Bar Graph: Displays the amount of load connected to the UPS in the AC and Battery mode as 20%, 40%; 60%, 80%, 100%.



When the amount of load attached to the UPS exceeds 110% of its power rating; the Overload and Fault icons will flash Off and On, the Overload error code will be displayed and the UPS will sound a constant alarm to indicate that there is an Overload condition.



Battery Capacity Bar Graph: Displays the amount of Battery Capacity available in the AC and Battery mode as 20%, 40%; 60%, 80%, 100%.

UPS Parameters:

Input Voltage and Frequency

Output Voltage and Frequency

Connected load KVA and KW

Estimated Runtime (minutes) - AC mode and Battery mode

The Multi-Function On/Off/Test button functions as follows:

When the UPS is off, press and then release the On/Off/Test button during the audible alarm's first beep to turn the UPS on.



When the UPS is on, press and then release the On/Off/Test button during the audible alarm's first beep to turn the UPS off.

When the UPS is in the AC mode, press and hold the On/Off/Test button until the audible alarm sounds four beeps, then release. The UPS will perform a 10-second Self-Test.



When the unit is operating in Battery mode, pressing the Alarm Silencer button will silence the audible alarm. Once the UPS reaches the LBW (Low Battery Warning) threshold the audible alarm will be re-activated. The audible alarm cannot be silenced during the LBW alarm. Once the UPS transfers to the AC mode the audible alarm will be reset to default.



The Scroll button allows the user to scroll through the UPS parameters that are available on the LCD screen.

NOTE: The LCD backlight will illuminate for 20-seconds when the UPS switches to the Battery mode and then turn off. When the UPS has an event and/or an error code the LCD backlight will turn on and remain on to alert the user that an event has occurred.

REAR PANEL

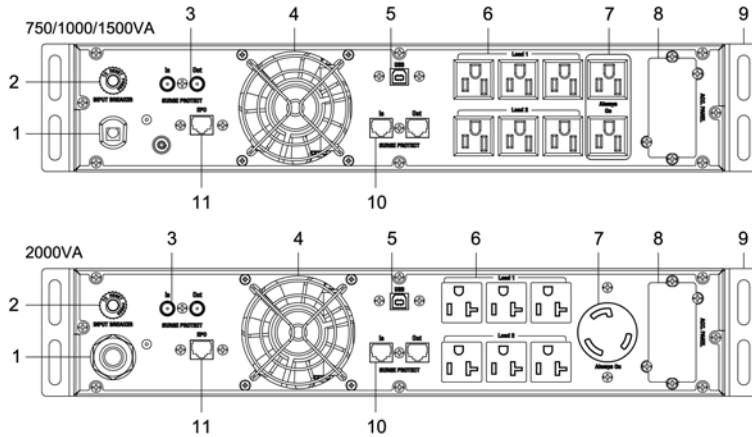

1. The input power cord is for connecting the UPS to utility power. **NOTE:** The AC wall outlet shall be near the UPS and easily accessible.
2. The input circuit breaker will trip in the event the load exceeds the UPS's power rating.
3. Coax connectors are for transient voltage surge suppression for cable modem, CATV converter, DSS receiver or DVR.
4. The fan is for ventilation. **NOTE:** The fan only operates during the battery mode and the AVR mode.
5. The USB Communications Port is for UPS monitoring and control.
6. The Battery Backup output receptacles. The output receptacles are electrically wired into two segments to support the "Load Shedding Function" (Labeled Load 1 & Load 2).
7. The Always On Battery Backup output receptacles (Labeled Always On) does not support the "Load Shedding Function". **NOTE:** The locking receptacle is only on the PRO2000RT2U model.
8. The option slot is for option cards.
9. The rackmount brackets are for mounting the UPS to the rack.
10. The RJ11/45 modular connectors are used for transient voltage surge suppression for 10/100/1000 Base-T Network/single line Phone/Fax/Modem.
11. The RJ11 EPO (Emergency Power Off) Port is for UPS control. This connection is not for Telecommunication use.

| Model # | Input Power Plug (All power cords are 10ft) | Output Power Receptacles |
|-------------|--|---|
| PRO750RT2U | NEMA 5-15P | 6-NEMA 5-15R (Controllable) 2-NEMA 5-15R (Always On) |
| PRO1000RT2U | NEMA 5-15P | 6-NEMA 5-15R (Controllable) 2-NEMA 5-15R (Always On) |
| PRO1500RT2U | NEMA 5-15P | 6-NEMA 5-15R (Controllable) 2-NEMA 5-15R (Always On) |
| PRO2000RT2U | NEMA 5-20P | 6-NEMA 5-15/20R (Controllable) 1-NEMA L5-20R (Always On) |

Chapter 3: Installation

INSTALLATION PLACEMENT



This UPS series is **ONLY** intended to be installed in an indoor temperature controlled environment that is free of conductive contaminants. **DO NOT** operate the UPS in: extremely dusty and/or unclean areas, locations near heating devices, water or excessive humidity, or where the UPS is exposed to direct sunlight. Select a location, which will provide good air circulation for the UPS at all times. Route power cords so they cannot be walked on or damaged. This UPS series is not intended for use in a computer room as defined in the Standard for the Protection of Electronic Computer/Data Processing Equipment ANSI/NFPA 75. Typical battery life is 3 to 5 years. Environmental factors do affect battery life. High temperatures, poor utility power, and frequent, short duration discharges have a negative impact on battery life.

- Operating Temperature (Maximum): 40°C (+32 to +104°F)
- Operating Elevation: 0 to 3,000m (0 to +10,000 ft)
- Operating and Storage Relative Humidity: 95%, non-condensing
- Storage Temperature: -15 to +45°C (+5 to +113°F)
- Storage Elevation: 0 to 15,000m (0 to +50,000 ft)

INSTALLATION

Be sure to read the installation placement and all the cautions before installing the UPS. Place the UPS in the final desired location and complete the rest of the installation procedure. These UPSs are shipped with the internal batteries disconnected. The batteries must be connected before putting these UPSs into service. See the "Connecting the Batteries" procedure to connect the batteries and then the "Rackmount Configuration" to install the UPS into the rack. Use **CAUTION:** The UPS is heavy. Use the appropriate number of personnel when installing the UPS.

CAUTION! DO NOT USE THE MOUNTING BRACKETS TO LIFT THE UPS. The mounting brackets are **ONLY** for securing the UPS to the rack.

ATTENTION! N'UTILISEZ JAMAIS LES SUPPORTS DE MONTAGE POUR SOULEVER L'ONDULEUR. Ces supports sont **uniquement** conçus pour fixer l'onduleur au rack.

CONNECTING THE BATTERIES

(QUALIFIED SERVICE PERSONNEL ONLY)

Please read all of the **WARNINGS** and **CAUTIONS** before attempting to connect the batteries.

CAUTION! DO NOT USE THE MOUNTING BRACKETS TO LIFT THE UPS. The mounting brackets are **ONLY** for securing the UPS to the rack.

ATTENTION! N'UTILISEZ JAMAIS LES SUPPORTS DE MONTAGE POUR SOULEVER L'ONDULEUR. Ces supports sont **uniquement** conçus pour fixer l'onduleur au rack.

Use two or more people when installing the UPS, the UPS is extremely heavy.

1. Remove the UPS from the shipping box and place on a flat surface.

NOTE: No tools are required for removing or installing the battery door.

2. Grasp the battery door on the left hand side, pull it outward and then set it aside (FIG. 1).

3. Verify proper polarity. Connect the battery connectors together. (FIG. 2).

NOTE: Some sparking may occur this is normal.

4. Re-install the battery door on the UPS.

5. Connecting the Batteries is complete. See the Rackmount Configuration.

FIG. 1

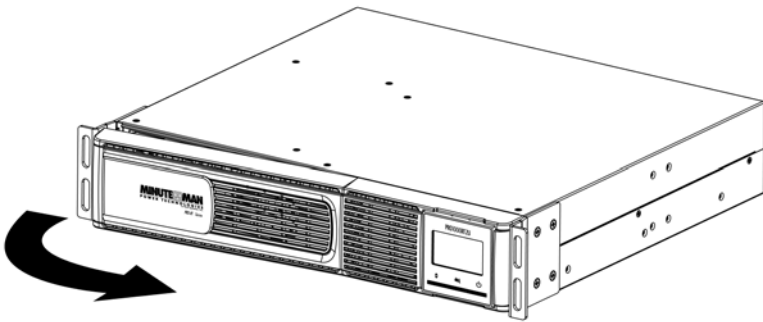
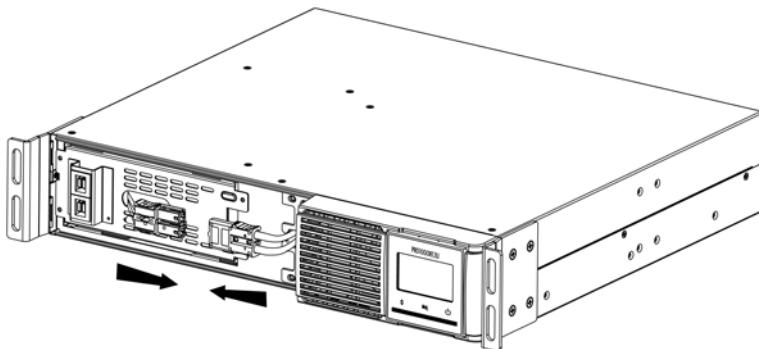

FIG. 2



RACKMOUNT CONFIGURATION

This UPS series comes with mounting brackets for the standard 19" (46.5cm) rack pre-installed on the UPS. The mounting brackets to fit a 23" (59.2cm) rack and Rail Kits for 4-post racks and cabinets are also available. The screws for mounting the UPS to the rack are included. **NOTE:** The mounting brackets can be mounted in the middle of the UPS.

CAUTION! DO NOT USE THE MOUNTING BRACKETS TO LIFT THE UPS. The mounting brackets are **ONLY** for securing the UPS to the rack.

ATTENTION! N'UTILISEZ JAMAIS LES SUPPORTS DE MONTAGE POUR SOULEVER L'ONDULEUR. Ces supports sont **uniquement** conçus pour fixer l'onduleur au rack.

1. Mount the UPS into the rack and secure with the four retaining screws provided. Use two or more people when installing the UPS, the UPS is extremely heavy. Do not move the rack after the units have been installed. The rack may become unstable due to the weight distribution.
2. The Rackmount Configuration is complete. See Connecting your Equipment.

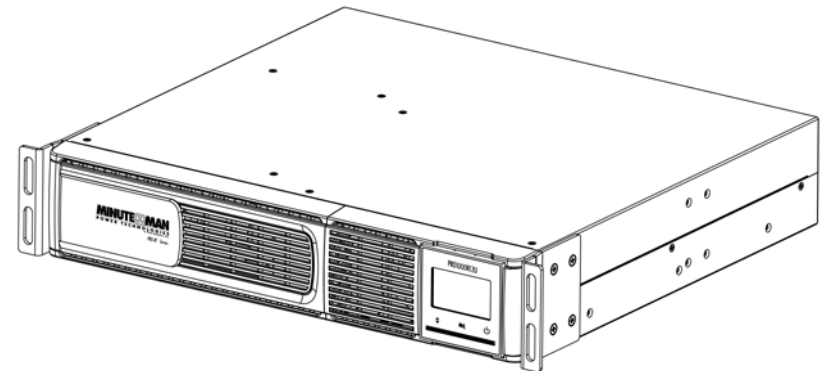

TOWER CONFIGURATION

The tower configuration allows the user to install the UPS in the up-right position. The tower brackets are provided with the UPS. Use two or more people when installing the UPS, the UPS is extremely heavy.

1. Once the location of the UPS has been determined, place the UPS on a flat surface, remove the rackmount brackets from the UPS and then place the tower brackets in the desired location.
2. The LCD panel can be rotated to read in the up-right position. There is a small slot on each side of the LCD panel. Insert a small flat head screwdriver into one of the small slots and gently pry the LCD outward. Position the LCD panel so that it reads in the upright position. Gently press LCD panel back into the front panel.

NOTE: The UPS must be installed in the proper up-right position. If the UPS is not installed in the proper up-right position the batteries will be damaged. Once the UPS is placed in the tower brackets in the up-right position, looking at the front panel the YELLOW Battery disconnected label on the top cover of the UPS MUST be on your left hand side.

3. Slide the UPS into the tower brackets. Make sure that the UPS is stable.
4. The Tower Configuration is complete. See Connecting your Equipment.

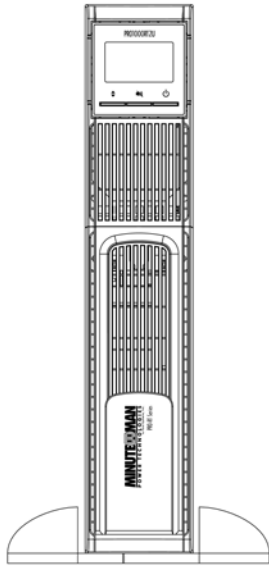

WALLMOUNT CONFIGURATION

The wallmount configuration allows the user to mount the UPS on the wall. There is a wallmount bracket kit available for the UPS. The kit includes two wall mounting brackets, ten retaining screws, and the wallmount template. Use two or more people when installing the UPS, the UPS is extremely heavy. The UPS's side panels have mounting bracket screw holes for attaching the wall mounting brackets.

1. Once the location of the UPS has been determined, place the UPS on a flat surface and remove the rackmount brackets from the UPS.

2. The LCD panel can be rotated to read in the up-right position. There is a small slot on each side of the LCD panel. Insert a small flat head screwdriver into one of the small slots and gently pry the LCD outward. Position the LCD panel so that it reads in the upright position. Gently press LCD panel back into the front panel.

NOTE: The UPS must be installed in the proper up-right position. If the UPS is not installed in the proper up-right position the batteries will be damaged. Once the UPS is attached to the wall, looking at the front panel the YELLOW Battery disconnected label on the top cover of the UPS MUST be on your left hand side.

3. Align the wall mounting brackets with the wall mounting bracket screw holes on the side panels of the UPS and attach with the six retaining screws.
4. Use the template to mark the screw hole position on the wall. Use CAUTION, you should always wear protective gear for your hands and eyes when operating power tools.
5. Attach the four retaining screws to the wall and make sure that all of the retaining screws are screwed into structural material. Then clean the area of any loose material. Do not tighten the retaining screws all the way, leave approximately 3/8" of the retaining screws sticking out.
6. Position the UPS, so that the mounting bracket keyed holes line up with the four retaining screws. Slide the UPS down until its resting securely on the four retaining screws.
7. Tighten the four retaining screws to secure the UPS to the wall.
8. The Wallmount Configuration is complete. See Connecting your Equipment.

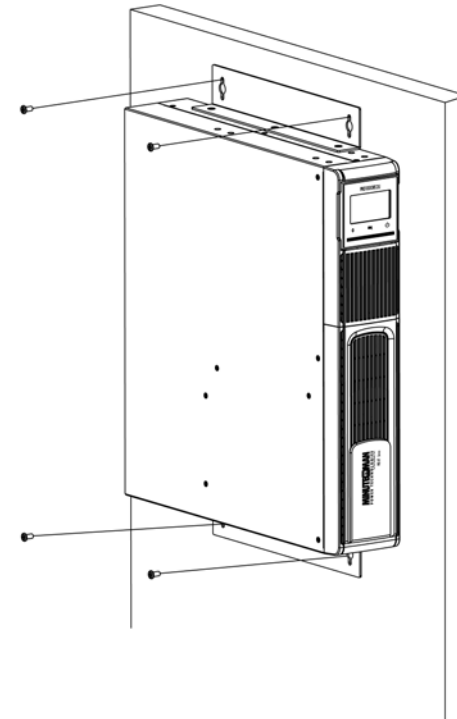

CONNECTING YOUR EQUIPMENT

Plug the equipment into the output receptacles on the rear panel of the UPS. Ensure that you do not exceed the maximum output rating of the UPS (refer to the information label or the Electrical Specifications in this manual). **DO NOT PLUG EXTENSION CORDS, ADAPTER PLUGS OR SURGE STRIPS INTO THE OUTPUT RECEPTACLES OF THE UPS**, there is a risk of damaging the UPS and/or connected equipment.

CAUTION! DO NOT connect a laser printer, copier, vacuum cleaner or any other large electrical device into the output receptacles of the UPS.

CONNECTING THE UPS TO AN AC SOURCE

CAUTION - To reduce the risk of fire, connect only to a utility powered circuit with 20 amperes maximum branch circuit over-current protection in accordance with the National Electric Code, ANSI/NFPA 70. Plug the UPS into a two pole, three wire, grounded receptacle only. The AC wall outlet shall be near the UPS and easily accessible. The plug on the input power cord on this UPS series is intended to serve as a disconnect device. **DO NOT PLUG THE UPS INTO EXTENSION CORDS, ADAPTER PLUGS, SURGE STRIPS OR POWER STRIPS. DO NOT CUT THE INPUT PLUG OFF AND ATTEMPT TO HARDWIRE THIS UPS, DOING SO WILL VOID THE WARRANTY.**

CONNEXION DE L'ONDULEUR À UNE SOURCE C.A.

ATTENTION! Pour réduire les risques d'incendie, faites le raccordement uniquement sur un circuit d'alimentation électrique équipé d'un dispositif de protection de surintensité de circuit de dérivation de maximum 20 ampères, conformément au Code national de l'électricité, ANSI/NFPA 70. Branchez l'onduleur uniquement sur une prise bipolaire à trois fils mise à la terre. **NE BRANCHEZ PAS L'ONDULEUR SUR UNE RALLONGE, UN ADAPTATEUR, UN LIMITEUR DE SURTENSION OU UNE BARRE MULTIPRISES. NE COUPEZ JAMAIS LE CONNECTEUR D'ENTRÉE POUR TENTER DE CÂBLER CET ONDULEUR; CECI ANNULERA LA GARANTIE.**

CHECKING THE SITE WIRING FAULT

After plugging the UPS into the AC wall outlet, check the Site Wiring Fault (SWF) icon on the front panel of the UPS. If the SWF icon is illuminated, the UPS is plugged into an improperly wired AC wall outlet. If the UPS indicates a Site Wiring Fault (SWF), have a Qualified Electrician correct the problem.

CHARGING THE BATTERY

The UPS will charge the internal batteries whenever the UPS is connected to an AC source and there is an acceptable AC voltage present (90-150VAC). It is recommended that the UPS's batteries be charged for a minimum of 4 hours before use. The UPS may be used immediately, however, the "On-Battery" runtime may be less than normally expected. **NOTE:** If the UPS is going to be out of service or stored for a prolonged period of time, the batteries must be recharged for at least twenty-four hours every ninety days.

USB COMMUNICATIONS PORT CONNECTION (OPTIONAL)

The power monitoring software and interface cable can be used with the UPS. Use only the interface cable that comes with these UPSs. The USB communications protocol is HID. The HID USB driver comes standard in the Windows OS. Simply connect the USB cable to the USB communications port on the rear panel of the UPS. Connect the other end of the USB cable to the device that will be monitoring/controlling the UPS and then follow the prompts on the screen. **NOTE:** When using the UPS's USB port with Windows XP, 7, 8 or 10 the Power Options in the Control Panel may need to be configured. Connecting to the Communications Port is optional. The UPS works properly without this connection.

POWER MONITORING SOFTWARE

This UPS series supports Minuteman's SentryHD power monitoring software. Please go to our web site at www.minutemanups.com/support, then look under Downloads, and then Software Download Center. Please download (Free of Charge) the latest version of the Minuteman SentryHD software.

RJ11 EPO (Emergency Power Off) PORT (OPTIONAL)

Connect one end of the RJ11 cable to the EPO port and the other end of the RJ11 cable to the EPO switch. In the AC or the Battery mode short pin4 to pin5 for approximately 0.5-seconds to shutdown the UPS. The UPS must be turned on to restart the UPS. **NOTE:** Connecting to the EPO port is optional. The UPS works properly without this connection. This connection is not for Telecommunication use.

NETWORK/PHONE/FAX/MODEM PROTECTION CONNECTION (OPTIONAL)

Connect a 10/100/1000 Base-T network, single line phone, Fax or Modem line to the RJ11/45 modular connectors on the rear panel of the UPS. This connection will require another length of telephone or network cable. The cable coming from the telephone service or networked system is connected to the port marked "IN". The equipment to be protected is connected to the port marked "OUT". **NOTE:** Connecting to the Network/Phone/Fax/Modem modular connectors is optional. The UPS works properly without this connection.

COAX PROTECTION CONNECTION (OPTIONAL)

Connect a cable modem, CATV converter, DSS receiver or DVR to the coax connectors on the rear panel of the UPS. This connection will require another coax cable. The cable coming from the coax service is connected to the port marked "IN". The equipment to be protected is connected to the port marked "OUT". **NOTE:** Connecting to the coax connectors is optional. The UPS works properly without this connection.

OPTION SLOT

The option slot on the rear panel of the UPS is for option cards. Contact your local dealer or visit our Web site at www.minutemanups.com for the available option cards for this UPS series.

Chapter 4: Operation

SYSTEM OVERVIEW

This Line-Interactive UPS protects computers, servers, telecom systems, VoIP systems, security systems, and a variety of electronic equipment from blackouts, brownouts, overvoltages, and surges. The AVR function continuously corrects the voltages, in-between the brownout and overvoltage transfer points (90 - 150VAC), to a safe usable level. When the UPS is operating in the AVR mode the audible alarm will remain silent and the AC mode indicator will blink. During normal AC operation, the UPS will quietly and confidently protect your system from power anomalies.

The UPS will charge the batteries with the UPS in the on or off position when the UPS is plugged into the wall outlet and there is an acceptable AC voltage present (90 - 150VAC). When a blackout, brownout, or an overvoltage condition occurs; the UPS will transfer to the battery mode, the On Battery indicator will illuminate and the audible alarm will sound once every ten seconds indicating that the commercial power is lost or unacceptable. When the commercial power returns or is at an acceptable level, the UPS will automatically transfer back to the AC mode and start recharging the batteries. During an extended outage when there is approximately two minutes of backup time remaining the audible alarm will sound twice every five seconds. This Low Battery Warning is informing the user that they should save all open files and turn off their computer. When the batteries reach the predetermined level the UPS will automatically shutdown protecting the batteries from over discharging. Once the commercial power returns and is at an acceptable level the UPS will automatically restart, providing safe usable power to the connected equipment and start recharging the batteries.

Block Diagram of the Basic Wiring and Internal Circuit Configuration

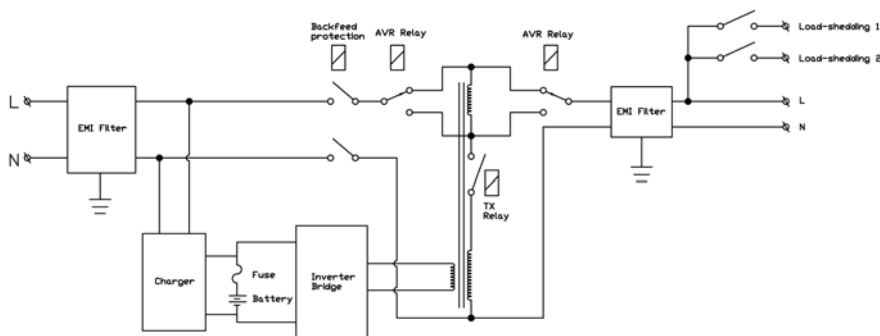

TURNING THE UNIT ON/OFF



On / Off / Test Button

When the UPS is connected to an AC source and there is an acceptable AC voltage present; Press and then release the On/Off/Test button during the audible alarm's first beep to turn the UPS on. UPS will provide an output and the load will be powered. Then the UPS will perform a five second self-test. Once the UPS has passed its self-test the UPS will be ready for normal operation.

When the UPS is in the AC mode; Press and then release the On/Off/Test button during the audible alarm's first beep to turn the UPS off. The UPS will continue to charge the batteries whenever it is plugged into an AC wall outlet and there is acceptable AC voltage present.

USER INVOKED SELF-TEST

The user invoked self-test feature is useful to verify the correct operation of the UPS and the condition of the batteries. With the UPS in the AC mode; Press and hold the On/Off/Test button until the audible alarm sounds four beeps, and then release. The UPS will perform a ten-second battery test to measure the battery's capability to support the connected load. During the battery test, the UPS will switch to the battery mode and the On-Battery icon will illuminate and the audible alarm will sound. If the UPS fails a battery test, one of the icons will remain illuminated and an error code will be displayed indicating the type of problem. **NOTE:** The UPS will automatically perform a self test on start-up.

ALARM SILENCER BUTTON

When the unit is operating in Battery mode, pressing the Alarm Silencer Button will silence the audible alarm. Once the UPS reaches the LBW (Low Battery Warning) threshold the audible alarm will be re-activated. The audible alarm cannot be silenced during the LBW alarm or any fault condition. Once the UPS transfers to the AC mode the audible alarm will be reset to default.

SCROLL BUTTON

Press the Scroll Button to scroll through the UPS parameters. The UPS parameters are displayed on the LCD screen.

LCD SCREEN

The LCD screen provides the user with a variety of useful information. The LCD has a real-time meter to display, in numeric fashion, the following data:

- Input Voltage and Frequency
- Output Voltage and Frequency
- Connected Load KVA and KW
- Estimated runtime in the AC and DC mode
- Error Codes
- Connected Load Capacity Bar Graph
- Battery Capacity Bar Graph

The LCD screen will include dedicated icons for the following information:

- AC Mode / AVR Mode (Boost and Buck: The AC mode icon will flash)
- On-Battery
- Weak/Bad Battery
- UPS Fault
- SWF (Site Wiring Fault)
- Overload
- EPo (Emergency Power Off)

The LCD backlight that will turn on when the UPS is turned on. After approximately 20-seconds the backlight will turn off to conserve energy. When an event (alarm) occurs, such as going to the battery mode, the backlight will turn on for approximately 20-seconds to alert the user that an event has occurred and then the backlight will turn off. While the Scroll button is in use the backlight will remain on. Approximately 20-seconds after the Scroll button has stopped being used the backlight will turn off.

LOAD SHEDDING FUNCTION

The output receptacles are electrically wired into two segments to support the "Load Shedding Function" (Labeled Load 1 & Load 2). The user can control the two segments individually or both at the same time. The Load Shedding Function is controllable by the Power Monitoring Software or the SNMP card. **NOTE:** The output segment labeled 'Always On' does not support the "Load Shedding Function".

EMERGENCY POWER OFF (EPo) FUNCTION

Connect one end of the RJ11 cable to the REPO port and the other end of the RJ11 cable to the EPO switch. In the AC or the Battery mode short pin4 to pin5 for approximately 0.5-seconds to shutdown the UPS. The UPS must be turned on to restart the UPS. The LCD screen will display EPo for this function.

POWER MONITORING SOFTWARE

This UPS series supports Minuteman's SentryHD power monitoring software. Please go to our web site at www.minutemanups.com/support, then look under Downloads, and then Software Download Center. Please download (Free of Charge) the latest version of the Minuteman SentryHD software. The USB communications protocol is HID. The HID USB driver comes standard in the Windows OS. Simply connect the USB cable to the USB communications port on the rear panel of the UPS. Connect the other end of the USB cable to the device that will be monitoring/controlling the UPS and then follow the prompts on the screen. **NOTE:** When using the UPS's USB port with Windows XP, 7, 8 or 10 the Power Options in the Control Panel may need to be configured.

ALARMS

ON BATTERY

When the UPS is operating on the batteries, the AC mode icon will extinguish, the On-Battery icon will illuminate, the LCD will display the estimated runtime remaining and the audible alarm will sound one beep every 10 seconds. Once the UPS returns to the AC mode, the audible alarm will stop, the On-Battery icon will extinguish and the AC mode icon will illuminate.

LOW BATTERY WARNING

When the batteries reach the predetermined level, the audible alarm will sound two beeps every five seconds, the Battery Bar Graph will display the remaining battery capacity and the LCD will display error code E07. This information is to inform the user that there is approximately two minutes of runtime remaining before the UPS shuts down. This condition will continue until either AC returns or the UPS's self protection circuit shuts the UPS down to protect the battery from over discharging.

WEAK/BAD BATTERY

The UPS automatically tests the battery's condition. If the battery is weak, bad or disconnected, the Weak/Bad Battery icon will illuminate and the Battery Capacity Bar Graph will turn off, the LCD screen will display error code E06 and the audible alarm will sound three beeps every five minutes until the battery is either reconnected or replaced. This alarm will be repeated until the batteries pass a self-test. It is recommended that the UPS be allowed to charge overnight before performing a battery test to confirm a Weak/Bad Battery condition.

OVERLOAD

When the amount of load attached to the UPS exceeds its power rating, the Overload icon will illuminate, the LCD screen will display error code E02 and the audible alarm will sound continuously (AC and Battery modes). This alarm will remain on until the excess load is removed or the UPS's self protection circuit shuts the UPS down.

To clear the overload alarm when the UPS has shutdown requires that the UPS perform a battery test. First remove part of the load, then turn the UPS on, the Overload icon and the audible alarm will be on. Second either use the Test Button or unplug the input power cord to perform the battery test.

UPS FAULT

When the UPS detects an internal fault, the Fault icon will illuminate and an error code will be displayed on the LCD screen, the audible alarm will sound continuously and the output will be turned off. The fault condition, in some instances, may be cleared by turning the UPS off and then on. If the fault condition does not clear the UPS must be sent in for service. See the Troubleshooting section.

Chapter 5: Obtaining Service

IF THE UPS REQUIRES SERVICE

1. Use the Troubleshooting section to eliminate obvious causes.
2. Verify there are no tripped circuit breakers and that the batteries are good. A tripped circuit breaker and defective batteries are the most common issues.
3. Call your dealer for assistance. If you cannot reach your dealer, or if they cannot resolve the issue call or fax the Technical Support department at the following numbers; Voice phone (972) 446-7363, FAX line (972) 446-9011 or visit our Web site at <http://www.minutemanups.com/callrequest.php>. Before calling the Technical Support Department have the following information available:
 - a) Contact name and address.
 - b) Where and when the unit was purchased.
 - c) The model number of your unit.
 - d) The serial number of your unit.
 - e) Any information on the failure, including icons that may be illuminated or error codes displayed.
 - f) A description of the protected equipment including model numbers, if possible.
 - g) A technician will ask you for the above information and if possible, help solve the issue over the phone. In the event that the unit requires factory service, the Technical Support Representative will issue you a Return Material Authorization Number (RMA #). **NOTE: We must have the model number and the serial number of the product to issue an RMA #.**
 - h) If the unit is under warranty, the repairs will be done at no charge. If the unit is not under warranty there will be a charge for the repair.
4. Pack the unit in its original packaging. If the original packaging is no longer available, ask the Technical Support Representative about obtaining a new set. It is important to pack the unit properly in order to avoid damage in transit. Never use Styrofoam beads for a packing material.
 - a) Include a letter with your name, address, day time phone number, RMA number, a copy of your original sales receipt, and a brief description of the problem.
5. Mark the RMA # on the outside of all packages. The factory cannot accept any package without the RMA # marked on the outside.
6. Return the unit by insured, prepaid carrier to:

Para Systems Inc.
 MINUTEMAN UPS
 1809 W. Frankford Road, Suite 150
 Carrollton, TX 75007
 ATTN: RMA # _____

Chapter 6: Troubleshooting

| Symptom / Error Code | Cause / What To Do |
|---|---|
| UPS will not turn on. | Press the On/Off/Test button and release after one beep. |
| UPS operates in battery mode only, even though there is AC present. | Reset the input circuit breaker by pressing the plunger back in. If the input circuit breaker trips after the UPS restarts, reduce the load on the UPS. |
| The AC mode icon is blinking and the alarm is silent. | The UPS is in either the Boost or the Buck mode. It is performing its intended function. |
| UPS does not provide expected runtime. | Charge the batteries for 8-hours and retest. If the runtime is still less than expected, the batteries may need to be replaced. |
| The AC mode icon is illuminated, but there is no output. | Disconnect the computer cable from the UPS, press the On button. If UPS works normally, the software had control of the UPS. |
| Fault icon is illuminated and a constant alarm. | The UPS has an internal problem, call for service. |
| Error Code: E01. UPS is shutdown. | The UPS has detected a short-circuit on its output. Check the attached load. |
| Error Code: E02. Overload icon is illuminated and a constant alarm. | Check the specifications and remove part of the load. If the UPS shuts down because of an Overload, the UPS must perform an Inverter function or a Self Test to clear the Overload Alarm. |
| Error Code: E03. Over Temperature Shutdown. | The internal or ambient temperature has exceeded the safe operating range for the UPS. Check the specifications. |
| Error Code: E04. Inverter/Output Failure Shutdown. | The UPS has an internal fault, call for service. |
| Error Code: E05. Charger Failure Warning. | The charger has failed, call for service. |
| Error Code: E06. Weak/Bad Battery icon is illuminated. | Check the battery connections, charge the batteries for 8-hours and retest, or replace the batteries. |
| Error Code: E07. Low Battery Warning. | The UPS's battery reserve is low. This condition will continue until AC returns or the UPS shuts down from battery exhaustion. |
| Error Code: E08. SWF icon is illuminated. | Have a qualified electrician correct the service wiring. |

Chapter 7: Replacing the Battery

REPLACING THE BATTERY

(QUALIFIED SERVICE PERSONNEL ONLY)

Please read all of the **WARNINGS** and **CAUTIONS** before attempting to service the batteries. Typical battery life is 3 to 5 years. Environmental factors do affect battery life. High temperatures, poor utility power, and frequent, short duration discharges have a negative impact on battery life.

WARNING! This UPS contains potentially hazardous voltages. Do not attempt to disassemble the UPS beyond the battery replacement procedure. This UPS contains no user serviceable parts. Repairs and battery replacement must be performed by **QUALIFIED SERVICE PERSONNEL ONLY**.

AVERTISSEMENT! Cet onduleur contient des tensions potentiellement dangereuses. N'essayez pas de le démonter au-delà de la procédure de remplacement d'une batterie. L'onduleur ne contient aucune pièce réparable par l'utilisateur. **SEUL UN TECHNICIEN QUALIFIÉ** est autorisé à effectuer les réparations et le remplacement d'une batterie.

CAUTION: Do not open or mutilate batteries. Released electrolyte is harmful to the skin and eyes and may be toxic.

ATTENTION! Évitez d'ouvrir ou d'abîmer les batteries. L'électrolyte qu'elles contiennent nuit à la peau et aux yeux et peut être toxique.

CAUTION: Do not dispose of batteries in a fire. The batteries may explode. The batteries in this UPS are recyclable. Dispose of the batteries properly. The batteries contain lead and pose a hazard to the environment and human health if not disposed of properly. Refer to local codes for proper disposal requirements or return the battery to the supplier.

ATTENTION! N'essayez jamais de vous débarrasser d'une batterie en la brûlant. Elle risque d'exploser. Les batteries de cet onduleur sont recyclables. Éliminez-les de manière appropriée. Les batteries contiennent du plomb et posent un danger pour l'environnement et la santé si elles ne sont pas éliminées de façon appropriée. Consultez les codes locaux pour savoir comment correctement éliminer une batterie ou renvoyez-la au fournisseur.

CAUTION: The battery system can present a risk of electrical shock. These batteries produce sufficient current to burn wire or tools very rapidly, producing molten metal. Observe these precautions when replacing the batteries:

1. Remove watches, rings, or other metal objects.
2. Use hand tools with insulated handles.
3. Wear protective eye gear (goggles), rubber gloves and boots.
4. Do not lay tools or other metal parts on top of batteries.
5. Disconnect the charging source prior to connecting or disconnecting the battery terminals.
6. Determine if the battery is inadvertently grounded. If the battery is, remove the source of the grounding. Contact with any part of a grounded battery can result in an electrical shock. The likelihood of such shock will be reduced, if such grounds are removed during installation and maintenance.

ATTENTION! Les batteries peuvent entraîner le risque de choc électrique. Elles produisent suffisamment de courant pour brûler très rapidement des fils ou outils, les causant à fondre. Prenez les précautions suivantes lors du remplacement d'une batterie.

1. Retirez votre montre, bagues ou autres objets métalliques.
2. Utilisez des outils à main à poignées isolantes.
3. Portez des lunettes de protection, des gants en caoutchouc et des bottes.
4. Ne placez jamais des outils ou autres objets en métal sur le dessus d'une batterie.
5. Déconnectez la source d'alimentation avant de brancher ou de débrancher les bornes d'une batterie.
6. Vérifiez si, par inadvertance, la batterie est toujours mise à la terre. Si c'est le cas, supprimez la source de mise à terre. Le contact avec n'importe quelle partie d'une batterie mise à la terre peut causer un choc électrique. La suppression de dispositifs de mise à terre pendant l'installation et l'entretien réduit le risque de chocs électriques.

CAUTION: Replace the batteries with the same number and type as originally installed in the UPS. These batteries have pressure operated vents. These UPSs contain sealed non-spillable maintenance-free lead acid batteries.

ATTENTION! Remplacez les batteries par des batteries du même numéro et type que celles d'origine. Une batterie de numéro et type différents peut causer une explosion. Les batteries sont équipées de purgeurs actionnés par pression. Les onduleurs contiennent des batteries au plomb étanches et inversables qui ne requièrent aucun entretien.

| | | | | |
|-----------------------|------------|-------------|-------------|-------------|
| Model # | PRO750RT2U | PRO1000RT2U | PRO1500RT2U | PRO2000RT2U |
| Battery Module Part # | BM0072 | BM0073 | BM0074 | BM0075 |

BATTERY REPLACEMENT PROCEDURE

PLEASE READ THE CAUTIONS AND WARNINGS BEFORE ATTEMPTING TO REPLACE THE BATTERIES

Hot-swappable batteries mean that the batteries can be replaced without powering down the whole UPS system.

NOTE: If there is a power interruption while replacing the hot-swappable batteries, with the UPS on, the load will not be backed up. To hot-swap the battery module start with step number 6.

1. Turn off the equipment that is plugged into the output of the UPS.
2. Press the On/Off/Test Button on the front panel to turn the UPS off.
3. Unplug the UPS's AC power cord from the AC wall outlet.
4. Unplug the equipment from the output receptacles of the UPS.
5. Unplug the computer interface cable from the rear panel of the UPS.

NOTE: No tools are required for removing or installing the battery door.

6. Grasp the battery door on the left hand side, pull it outward and then set it aside. (FIG. 1)

FIG. 1

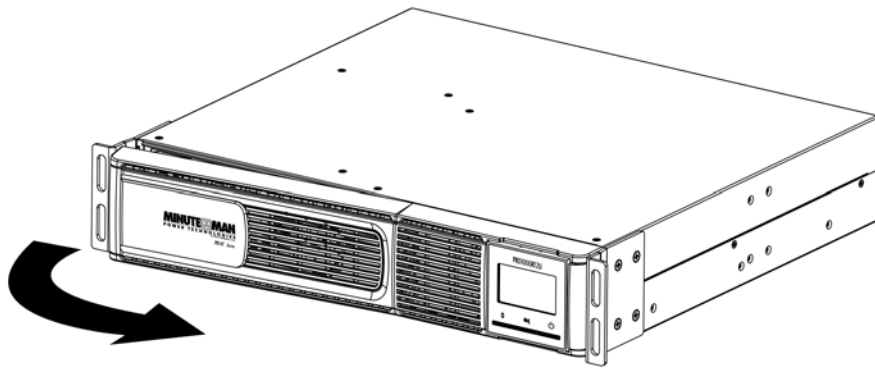

7. Disconnect the battery connectors. (FIG. 2)
8. Remove the four retaining screws for the battery retaining bracket. (FIG. 2)
9. Remove the battery retaining bracket and set aside.

FIG. 2

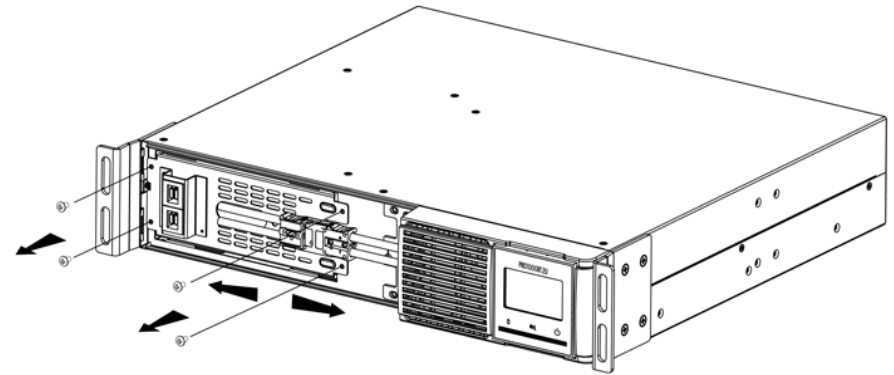

10. Grasp the battery pull tab and gently pull the battery module out of the UPS and set aside. (FIG. 3)

NOTE: DO NOT use the battery wires to pull the battery module out. Use Caution, the battery module is heavy.

FIG. 3

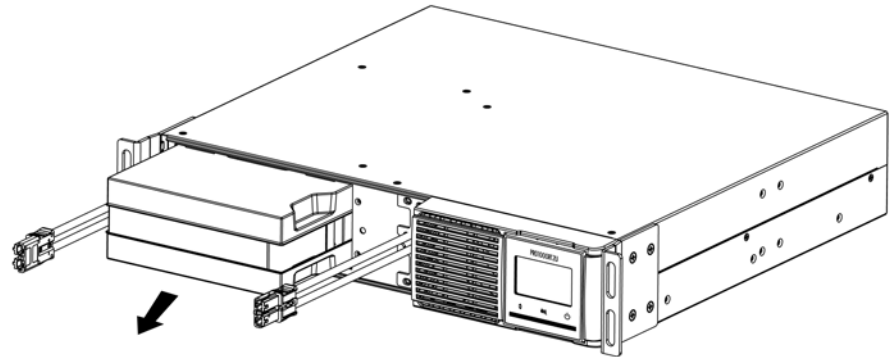

11. Slide the new battery module into the UPS.
12. Re-install the battery retaining bracket.
13. Re-install the four retaining screws for the battery retaining bracket.
14. Verify proper polarity. Reconnect the battery connectors together.
15. Re-install the battery door on the UPS.
16. Properly dispose of the old batteries at an appropriate recycling facility or return them to the supplier in the packing material for the new batteries.
17. The UPS is now ready for the normal operation.

NOTE: If the UPS has a Weak/Bad Battery Alarm after replacing the battery module, the user must initiate a self-test to clear the Weak/Bad Battery Alarm. To initiate a self-test see section 4 "**TEST BUTTON**".

Chapter 8: Specifications

SYSTEM SPECIFICATIONS

| | | | | |
|------------------------|---------------------------------------|----------------|-----------------|-----------------|
| Model Number | PRO750RT2U | PRO1000RT2U | PRO1500RT2U | PRO2000RT2U |
| Topology | Line-Interactive, Simulated Sine Wave | | | |
| Maximum Power Capacity | 750VA 525W | 1000VA 700W | 1500VA 1050W | 2000VA 1400W |

INPUT

| | | | |
|-----------------------------|---|--|------------|
| Number of Phase | Single (1Ø 2W +G) | | |
| Nominal Voltage | 120VAC | | |
| Acceptable Input voltage | 0 - 150VAC | | |
| Voltage Range | 90 - 150VAC | | |
| Frequency Limits | 60 Hz, ±6Hz | | |
| Low Voltage Transfer Point | 89V resets to Utility Power at 94V or higher | | |
| High Voltage Transfer Point | 151V resets to Utility Power at 146V or lower | | |
| Protection | Resettable Circuit Breaker | | |
| Power Cord (10ft) | NEMA 5-15P | | NEMA 5-20P |

OUTPUT NON-BATTERY OPERATION

| | |
|------------------------|------------------|
| Voltage Range | 103 - 136VAC |
| Voltage Regulation | 120VAC: ±13.3% |
| Frequency Range | 60Hz: 54 - 66Hz |
| Efficiency (Line Mode) | >96% (Full Load) |

OUTPUT BATTERY OPERATION

| | | |
|--------------------|--|--------------------------|
| Waveform Type | Simulated Sine Wave | |
| Nominal Voltage | 120VAC | |
| Voltage Regulation | 120VAC ±5% (until Low Battery Warning) | |
| Frequency | 60Hz, ±0.5Hz (unless synchronized to utility) | |
| Transfer Time | 6-10 ms Typical | |
| Overload Capacity | AC Mode: 110% for 1-minute then shutdown, 150% Shutdown Immediately DC Mode: 110% for 20-seconds then shutdown, 150% Shutdown Immediately | |
| Protection | Over-Current, Short-Circuit Protected and Latching Shutdown | |
| Receptacles (NEMA) | 8: 5-15R | 6: 5-15/20R 1: L5-20R |

REGULATORY COMPLIANCE

| | |
|----------------------|--|
| Safety and Approvals | cTUVus (Conforms to UL1778 5th Edition & CSA 22.2 no. 107.3-14 / R: 2014), FCC Class B, CE certified, Energy Star certified, RoHS2 (EU Directive 2011/65/EU) |
|----------------------|--|

BATTERY SYSTEM

| | | | | |
|------------------------------|--|--------|--------|--------|
| Battery Type | Sealed, Non-Spillable, Maintenance Free, Value Regulated Lead Acid | | | |
| Typical Recharge Time | 8-hours to 90% capacity from a full load discharge | | | |
| Typical Battery Life | 3 to 5 years. Environmental factors do affect battery life. High temperatures, poor utility power, and frequent, short duration discharges have a negative impact on battery life. | | | |
| Battery Module Part # | BM0072 | BM0073 | BM0074 | BM0075 |
| Runtime: Full Load (minutes) | 5 | 4 | 4 | 4 |
| Runtime: Half Load (minutes) | 15 | 14 | 14 | 14 |

SURGE PROTECTION AND FILTERING

| | |
|--|--|
| UPS Surge Energy Rating | 960 J |
| Surge Current Capability | 6500 Amps total (one time 8 to 20us waveform) |
| Response Time | 0 ns (instantaneous) normal mode; <5 ns common mode |
| Surge voltage let-through (as a percentage of an applied ANSI C62.41 Cat. A ±2 kV) | < 0.30% |
| Noise Filter | >45db normal and common mode EMI/RFI suppression |
| Audible Noise at 1 m (3 ft.) | <45 dBA |
| Network/Phone/Fax/Modem transient voltage surge protection | 10/100/1000 Base-T network, single line phone, Fax or Modem. 1-in / 1-out combo RJ11/45 connectors |
| Coax transient voltage surge protection | Cable modem , CATV converter, DSS receiver, DVR. 1-in / 1-out |

ENVIRONMENTAL

| | |
|----------------------------|--------------------------------|
| Operating Temperature | 0 to 40°C (+32 to +104°F) |
| Operating Elevation | 0 to 3000m (0 to +10,000 ft) |
| Operating/Storage Humidity | 5- 95% Non-Condensing |
| Storage Temperature | -15 to +45°C (+5 to +113°F) |
| Storage Elevation | 0 to 15,000m (0 to +50,000 ft) |

PHYSICAL

| | | | | |
|------------------------------|---|---|----------------------|----------------------|
| Size - Net L X W X H | 16.1 X 18.9 X 3.4" 410 X 480.6 X 86.2 mm | 20.1 X 18.9 X 3.4" 510 X 480.6 X 86.2 mm | | |
| Weight - Net | 31.3 lbs 14.2 Kgs | 35.7 lbs 16.2 Kgs | 48.7 lbs 22.1 Kgs | 62.8 lbs 28.5 Kgs |
| Size - Shipping L X W X H | 22.4 X 21.7 X 9.4" 570 X 550 X 240 mm | 26.4 X 22.4 X 9.4" 670 X 570 X 240 mm | | |
| Weight - Shipping | 37.5 lbs 17.0 Kgs | 41.9 lbs 19.0 Kgs | 56.4 lbs 25.6 Kgs | 70.5 lbs 32.0 Kgs |

Chapter 9: Limited Product Warranty

Para Systems, Inc. (Para Systems) warrants this equipment, when properly applied and operated within specified conditions, against faulty materials or workmanship for a period of three years from the date of purchase. For equipment sites within the United States and Canada, this warranty covers depot repair or replacement of defective equipment at the discretion of Para Systems. Depot repair will be from the nearest authorized service center. The customer pays for shipping the product to Para Systems. Para Systems pays ground freight to ship the product back to the customer. Replacement parts and warranty labor will be borne by Para Systems. For equipment located outside of the United States and Canada, Para Systems only covers faulty parts. Para Systems products that are depot repaired or replaced pursuant to this warranty shall only be warranted for the unexpired portion of the warranty applying to the original product. This warranty applies only to the original purchaser who must have properly registered the product within 10 days of purchase.

The warranty shall be void if (a) the equipment is damaged by the customer, is improperly used, is subjected to an adverse operating environment, or is operated outside the limits of its electrical specifications; (b) the equipment is repaired or modified by anyone other than Para Systems or Para Systems approved personnel; or (c) has been used in a manner contrary to the product's User's Manual or other written instructions.

Any technical advice furnished before or after delivery in regard to use or application of Para Systems' equipment is furnished without charge and on the basis that it represents Para Systems' best judgment under the circumstances, but it is used at the recipient's sole risk.

EXCEPT AS PROVIDED HEREIN, PARA SYSTEMS MAKES NO WARRANTIES, EXPRESSED OR IMPLIED, INCLUDING WARRANTIES OF MERCHANTABILITY AND FITNESS FOR A PARTICULAR PURPOSE. Some states do not permit limitation of implied warranties; therefore, the aforesaid limitation(s) may not apply to the purchaser.

EXCEPT AS PROVIDED ABOVE, IN NO EVENT WILL PARA SYSTEMS BE LIABLE FOR DIRECT, INDIRECT, SPECIAL, INCIDENTAL, OR CONSEQUENTIAL DAMAGES ARISING OUT OF THE USE OF THIS PRODUCT, EVEN IF ADVISED OF THE POSSIBILITY OF SUCH DAMAGE. Specifically, Para Systems is not liable for any costs, such as; labor for on-site installation, on-site maintenance or on-site service, lost profits or revenue, loss of equipment, loss of use of equipment, loss of software, loss of data, cost of substitutes, claims by third parties, or otherwise. The sole and exclusive remedy for breach of any warranty, expressed or implied, concerning Para Systems' products and the only obligation of Para Systems hereunder, shall be depot repair or replacement of defective equipment, components, or parts; or, at Para Systems' option, refund of the purchase price or substitution with an equivalent replacement product. This warranty gives you specific legal rights and you may also have other rights which vary from state to state.

No employee, salesman, or agent of Para Systems is authorized to add to or vary the terms of this warranty.

A1. DECLARATION OF CONFORMITY

Application of Council Directive(s): 2014/35/EU, 2014/30/EU, cTUVus (for UL1778)

Standard(s) to which Conformity is declared: EN61000-3-2, EN61000-3-3, EN62040-2, IEC61000-2-2 IEC61000-4-2, IEC61000-4-3, IEC61000-4-4, IEC61000-4-5, IEC61000-4-6, IEC61000-4-8, IEEE C62.41 Category A1, UL1778, CSA 22.2 no. 107.3-14 / R: 2014, FCC Class B

Manufacturer's Name: Para Systems, Inc. (MINUTEMAN UPS)

Manufacturer's Address: 1455 LeMay Drive
Carrollton, Texas 75007 USA

Type of Equipment: Uninterruptible Power Supplies (UPS)

Model No: PRO750RT2U (Y), PRO1000RT2U (Y), PRO1500RT2U (Y),
PRO2000RT2U (Y)

Year of Manufacture: Beginning January 2018

I hereby declare that the equipment specified above conforms to the above Directive(s).

Robert Calhoun
(Name)

Manager Engineering
(Position)

Place: Carrollton, Texas, USA

Date: January 2, 2018



Notes:



Notes: