

# STAR-LIGHT Universal HD over Coax™ Indoor/ Outdoor Dome Cameras

**DWC-V7253WTIR**



**User's Manual** Ver. 08/17

Before installing and using the camera, please read this manual carefully.  
Be sure to keep it handy for future reference.

 **STAR-LIGHT™**

Universal HD Super Low Light Cameras

# Index

## **INTRODUCTION**

- 02 Safety Information
- 07 Features
- 08 Part Name
- 09 Dimension
- 10 Product & Accessories

## **INSTALLTION**

- 11 Installation
- 13 Connecting to Monitors
- 14 Control Board
- 15 Adjusting the Camera angle

## **OSD MENU**

- 16 Menu Tree
- 17 OSD Menu - Exposure
- 20 OSD Menu - Color
- 21 OSD Menu - Day&Night
- 22 OSD Menu - Function
- 23 OSD Menu - Motion
- 24 OSD Menu - Privacy
- 25 OSD Menu - Setup
- 27 OSD Menu - Exit

## **APPENDIX**

- 28 Troubleshooting
- 29 Specifications
- 31 Limits & Exclusions
- 32 Warranty

# Safety Information



**CAUTION**  
RISK OF ELECTRIC SHOCK.  
DO NOT OPEN



**CAUTION:**  
TO REDUCE THE RISK OF ELECTRIC SHOCK, DO NOT REMOVE COVER (OR BACK) NO USER SERVICEABLE PARTS INSIDE. REFER SERVICING TO QUALIFIED SERVICE PERSONNEL.



This symbol indicates that dangerous voltage consisting a risk of electric shock is present within this unit.



This exclamation point symbol is intended to alert the user to the presence of important operating and maintenance (servicing) instructions in the literature accompanying the appliance

## WARNING

To prevent damage which may result in fire or electric shock hazard, do not expose this appliance to rain or moisture.

## WARNING

1. Be sure to use only the standard adapter that is specified in the specification sheet. Using any other adapter could cause fire, electrical shock, or damage to the product
2. Incorrectly connecting the power supply or replacing battery may cause explosion, fire, electric shock, or damage to the product.
3. Do not connect multiple cameras to a single adapter. Exceeding the capacity may cause abnormal heat generation or fire.
4. Securely plug the power cord into the power receptacle. Insecure connection may cause fire.
5. When installing the camera, fasten it securely and firmly. A falling camera may cause personal injury.
6. Do not place conductive objects (e.g. screw drivers, coins, metal things, etc.) or containers filled with water on top of the camera. Doing so may cause personal injury due to fire, electric shock, or falling objects.

# Safety Information

7. Do not install the unit in humid, dusty, or sooty locations.  
Doing so may cause fire or electric shock.
8. If any unusual smells or smoke come from the unit, stop using the product.  
In such case, immediately disconnect the power source and contact the service center.  
Continued use in such a condition may cause fire or electric shock.
9. If this product fails to operate normally, contact the nearest service center.  
Never disassemble or modify this product in any way.
10. When cleaning, do not spray water directly onto parts of the product.  
Doing so may cause fire or electric shock.

## PRECAUTION

### Operating

- Before using, make sure power supply and all other parts are properly connected.
- While operating, if any abnormal condition or malfunction is observed, stop using the camera immediately and contact your dealer.

### Handling

- Do not disassemble or tamper with parts inside the camera.
- Do not drop the camera or subject it to shock or vibration as this can damage the camera.
- Clean the clear Lens cover with extra care. Scratches and dust can ruin the quality of the camera image.

### Installation and Storage

- Do not install the camera in areas of extreme temperature, exceeding the allowed range.
- Avoid installing in humid or dusty environments.
- Avoid installing in places where radiation is present.
- Avoid installing in places where there are strong magnetic fields and electric signals.
- Avoid installing in places where the camera would be subject to strong vibrations.
- Never expose the camera to rain or water.



# Important Safety Instructions

1. Read these instructions.
  - All these safety and operating instructions should be read before the product is installed or operated.
2. Keep these instructions.
  - The safety, operating and use instructions should be retained for future reference.
3. Heed all warnings.
  - All warnings on the product and in the operating instructions should be adhered to.
4. Follow all instructions.
  - All operating and use instructions should be followed.
5. Do not use this device near water.
  - For example: near a bath tub, wash bowl, kitchen sink, laundry tub, in a wet basement; near a swimming pool; etc.
6. Clean only with dry cloth.
  - Unplug this product from the wall outlet before cleaning. Do not use liquid cleaners.
7. Do not block any ventilation openings. Install in accordance with the manufacturer's instructions.
  - Slots and openings in the cabinet are provided for ventilation, to ensure reliable operation of the product, and to protect it from over-heating. The openings should never be blocked by placing the product on bed, sofa, rug or other similar surface. This product should not be placed in a built-in installation such as a bookcase or rack unless proper ventilation is provided and the manufacturer's unstructions have been adhere to.
8. Do not install near any heat sources such as radiators, heat registers, or other apparatus (including amplifiers) that produce heat.
9. Do not defeat the safety purpose of the polarized or grounding-type plug. A polarized plug has two blades with one wider than the other. A grounding type plug has two blades and a third grounding prong. The wide blade or the third prong are provided for your safety. If the provided plug does not fit into your outlet, consult an electrician for replacement of the obsolete outlet.
10. Protect the power cord from being walked on or pinched particularly at plugs, convenience receptacles, and the point where they exit from the apparatus.

## Important Safety Instructions

11. Only use attachments/accessories specified by the manufacturer.
12. Use only with cart, stand, tripod, bracket, or table specified by the manufacturer, or sold with the apparatus.  
When a cart is used, use caution when moving the cart/apparatus combination to avoid injury from tip-over.
13. Unplug this apparatus during lightning storms or when unused for long periods of time.
14. Refer all servicing to qualified service personnel. Servicing is required when the apparatus has been damaged in any way, such as power supply cord or plug is damaged, liquid has been spilled or objects have fallen into the apparatus, the apparatus has been exposed to rain or moisture, does not operate normally, or has been dropped.



## Disposal of Old Appliances



1. When this crossed-out wheel bin symbol is attached to a product it means the product is covered by the European Directive 2002/96/EC.
2. All electrical and electronic products should be disposed of separately from the municipal waste stream in accordance with laws designated by the government or the local authorities.
3. The correct disposal of your old appliance will help prevent potential negative consequences for the environment and human health.
4. For more detailed information about disposal of your old appliance, please contact your city office, waste disposal service or the shop where you purchased the product.



This equipment has been tested and found to comply with the limits for a Class A digital device, pursuant to part 15 of the FCC Rules.

These limits are designed to provide reasonable protection against harmful interference when the equipment is operated in a commercial environment.

This equipment generates, uses, and can radiate radio frequency energy and, if not installed and used in accordance with the instruction manual, may cause harmful interference to radio communications.

Operation of this equipment in a residential area is likely to cause harmful interference in which case the user will be required to correct the interference at his own expense.

# Features

- Universal HD over Coax™ Technology with HD-Analog, HD-TVI, HD-CVI and all Analog to 960H Signal Support
- STAR-LIGHT™ Super Low Light Technology
- 2.1MP 1/3" Image Sensor at Real-time 30fps
- Fixed Lens 3.6mm
- True Wide Dynamic Range (WDR)
- OSD Control Via Coaxial (UTC)
- 50' Smart IR™ with Intelligent Camera Sync.
- Smart DNR™ 3D Digital Noise Reduction
- True Day/Night Mechanical IR Cut Filter
- De-Fog™ Extreme Weather Image Compensation
- Highlight Masking Exposure (HME)
- Easy Icon Driven OSD Menu with Built-in Joystick
- Programmable Privacy Zones
- Auto Gain Control (AGC)
- Backlight Compensation (BLC)
- Dynamic Range Compressor (DRC) Reveals Low Light Detail
- Auto White Balance (AWB)
- IP66 Certified Weather and Tampering Resistant
- IK-10 Impact Rated
- 5 Year Warranty

# Part name

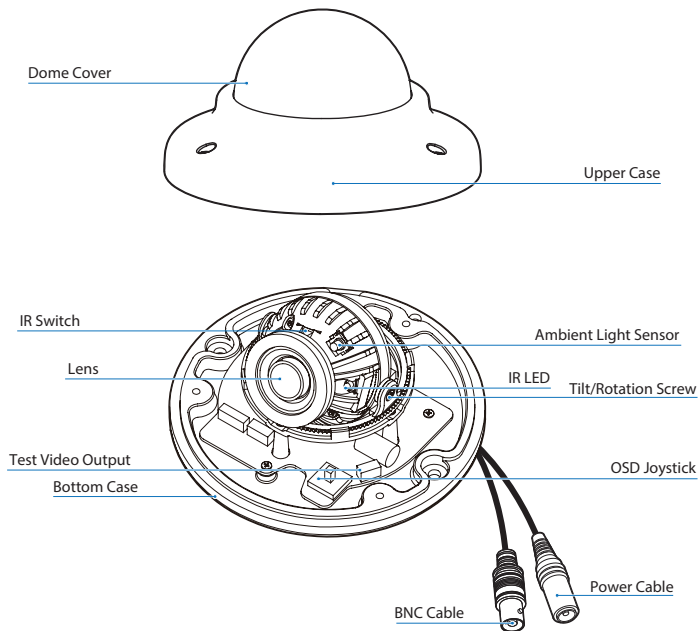

# Dimension

Unit : Inches (mm)

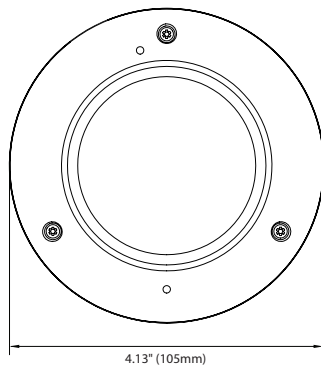
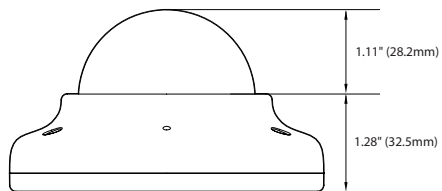

# Product & Accessories

☒ Please check if all the camera and accessories are included in the package.

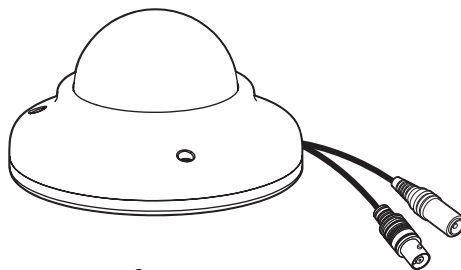

Camera

Cables

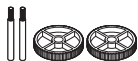

Mount Bolt & Nut



Torx Wrench



Screw &  
Plastic Anchor-2pcs

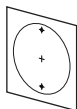

Template Sheet  
for installing by Bolt & Nut



Manual



Test Video Cable

☒ **NOTE:** The 'Test Video Cable' is used to test the camera by connecting to a portable display.

# Installation- Instructions

- 1 Detach the camera's cover dome from the camera's module by unscrewing the three cover dome screws using the Torx Wrench.
- 2 Use the camera or mounting template to mark and drill the necessary holes in the wall or ceiling.
- 3 Pull wires through and make connections.
- 4 Using three included screws, mount and secure the camera to the wall or ceiling.
- 5 Secure the camera's cover dome onto the camera base and remove the protecting film to complete the installation.

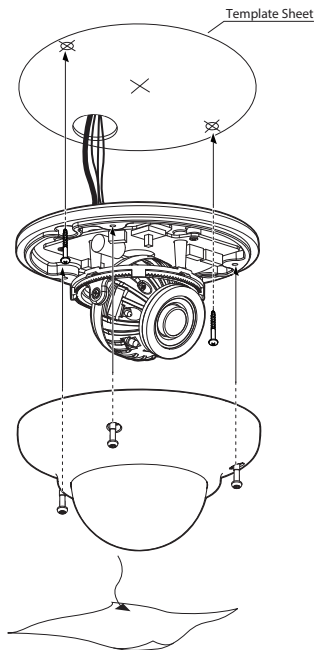

# Installation- Using Mount Bolt & Nut

- 1 Detach the camera's cover dome from the camera's module by unscrewing the three cover dome screws.
- 2 Using the camera or mounting template, mark and drill the necessary holes in the wall or ceiling.
- 3 Secure the two long mounting screws to the camera's base.
- 4 Pull wires through and make connections.
- 5 Mount the camera to the mounting surface using the 2 mounting nuts.
- 6 Secure the camera's cover dome onto the camera base to complete the installation.

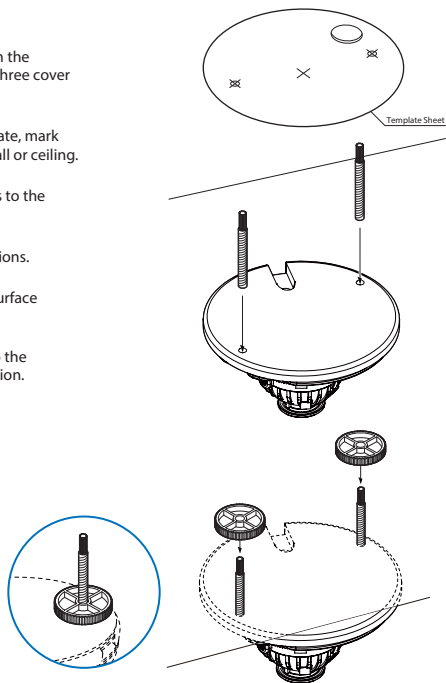



# Connecting to DVR/Encoder

Use the diagram below to connect to an Universal DVR or CRT Monitor properly.

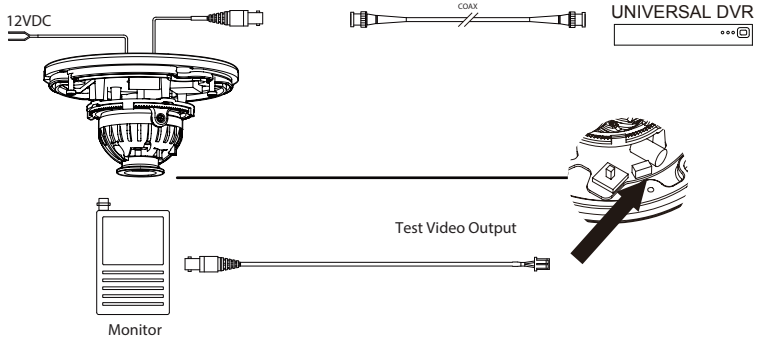

- Power Connection - 12vdc Voltage
- All cameras are equipped with a test video output for on-site configuration.

- OSD Joystick : The function setting and video output can be adjusted with OSD joystick. (default : HD-A)

## Image Mode

- Switches to HD-TVI mode when press OSD Joystick to left 5sec or longer.
- Switches to HD-A mode when press OSD Joystick to right 5sec or longer.
- Switches to CVBS mode when press OSD Joystick to up 5sec or longer.
- Switches to HD-CVI mode when press OSD Joystick to down 5sec or longer.

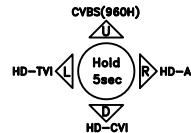

## Control Board

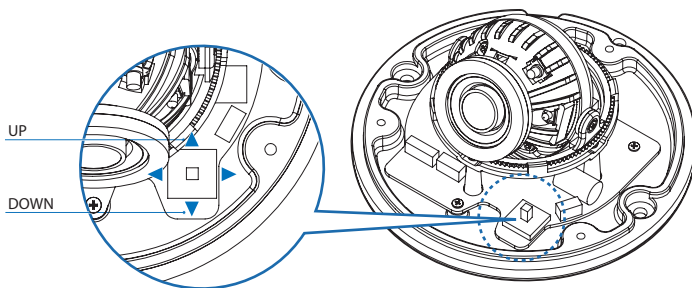

- 1 Remove the camera's dome cover to access the camera module and OSD joystick.
- 2 Use the Joystick to control the camera's OSD options.
- 3 The camera has a manual IR switch, located under the camera's lens. You can use this switch to manually turn the IR LED board on or off according to the installation needs.

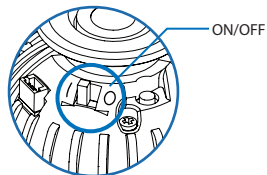

# Adjusting the Camera angle

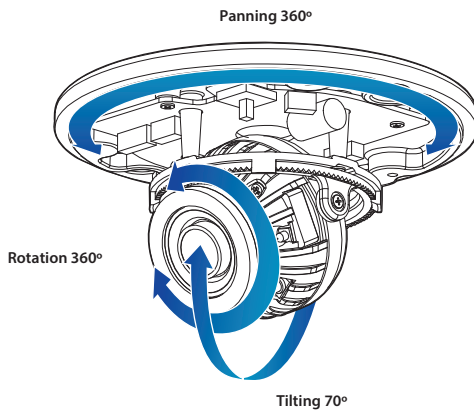

# OSD Menu Tree

**NOTE:** The function setting can be adjusted with both switch (OSD joystick) and remote control through RS485 or UTC. In case of camera without OSD joystick, it can be adjusted with coaxial (UTC) only.



## EXPOSURE

LENS	MANUAL / AUTO
BACKLIGHT	OFF / HME / BLC / WDR
DRC	OFF / LOW / MIDDLE / HIGH
DEFOG	OFF / ON
AGC	0 ~ 10
STARLIGHT	OFF / x2 ~ x32
3D DNR	OFF / LOW / MIDDLE / HIGH
EXIT JUMP	



## COLOR

WHITE BAL.	AUTO / AUTO-EX / PRESET / MANUAL
COLOR GAIN	0 ~ 20
EXIT JUMP	



## DAY & NIGHT

MODE	AUTO / COLOR / BW / EXTERN
CDS THRES	0 ~ 20
CDS MARGIN	0 ~ 20
EXTERN SW	LOW / HIGH
EXT LED	OFF / AUTO
DELAY	LOW / MIDDLE / HIGH
SMART IR	0 ~ 20
EXIT JUMP	



## FUNCTION

SHARPNESS	0 ~ 10
GAMMA	0.45 ~ 0.75
MIRROR	OFF / ON
FLIP	OFF / ON
EXIT JUMP	



## MOTION

MOTION	OFF / ON
DET WINDOW	
DET TONE	0 ~ 4
MDRECT FILL	OFF / ON
SENSITIVITY	0 ~ 10
MOTION OSD	OFF / ON
TEXT ALARM	OFF / ON
SIGNAL OUT	OFF / ON
EXIT JUMP	



## PRIVACY

PRIVACY	OFF / ON
ZONE NUM	0 ~ 15
ZONE DISP	OFF / ON
H-POS	0 ~ 59
V-POS	0 ~ 33
H-SIZE	0 ~ 60
V-SIZE	0 ~ 34
Y LEVEL	0 ~ 20
CB LEVEL	0 ~ 20
CR LEVEL	0 ~ 20
TRANS	0 ~ 3
EXIT JUMP	



## SETUP

COMMUNICA	
CAM TITLE	OFF / RIGHT UP / LEFT DOWN
IMAGE RANGE	FULL / COMP / USER
FREQ	50Hz / 60Hz
LANGUAGE	ENG/ CHN/ CHN(S)/ JPN / KOR
INITIAL	OFF / ON
EXIT JUMP	



## EXIT

SAVE & EXIT	
EXIT	

**NOTE:** The contents might be different some products.

# OSD Menu\_Exposure

## 1 LENS

**MANUAL :** Manual mode supports the fixed board lens or the manual iris lens.  
**AUTO :** AUTO mode sets the camera's iris automatically.

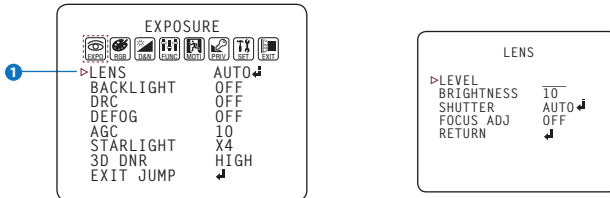

Under the LENS sub-menu, you can adjust the following settings:

### 1. Level

Change the camera's iris value manually. If AUTO is selected, this option is disabled.

### 2. Brightness

Adjust the camera's brightness from 0~20. The higher the number, the brighter the image will appear.

### 3. Shutter

Set the shutter speed to AUTO, Manual, or FLC (Flicker-less mode).

\* If AUTO is selected, select from the following options :

- NORMAL: Set when the camera is installed in an indoor environment.
- DEBLUR: Set when the camera is installed in an outdoor environment.

\* Select FLC if the camera is experiencing some flickering in the image.

The shutter speed will be set to 1/100 for NTSC, or 1/120 for PAL.

\* If Manual is selected, set the shutter speed from the options :

- 1/30(1/25) ~ 1/30000.

### 4. Focus Adjustment

When on, the default level is set automatically by controlling lens focus and based on the installation and environment circumstances.

# OSD Menu\_Exposure

## 2 BACKLIGHT

OFF

### HME HIGHLIGHT MASKING EXPOSURE

HME allows objects to appear clearly on the screen by masking extremely bright areas. To setup HME, set the level and color. The lower the setting, the darker the masking areas have to be. Select from: 0 ~ 20.

Color: Set the color of the HME mask. Select from:

BLACK / WHITE / YELLOW / CYAN / GREEN /

MAGENTA / RED / BLUE / CUSTOMIZE

### BLC BACK LIGHT COMPENSATION

If BLC is selected, adjust the size and position of the mask:

- H-POS: Move the Zone position left or right. The higher the number, the zone will move to the right.
- V-POS: Move the Zone position up or down. The higher the number, the zone will move down.
- H-Size: Reset the zone's size horizontally. The higher the number, the right side panel will move further to the right.
- V-Size: Reset the zone's size vertically. The higher the number, the bottom side panel will move further down.

### WDR Wide Dynamic Range

If WDR is selected, adjust the WDR level (Weight) in the sub-menu. Select from Low, Middle, or High (Default).

#### ROI (Region of interest)

To have more efficient scene result, up to 4 regions are able to be selected for WDR effect to maintain the most suitable color appearances.

- ROI WDR&3D-DNR functions can't be operated simultaneously. Once the WDR may activate then the DNR function shifts to 2D-DNR although DNR functions set by 3D-DNR as default setting.

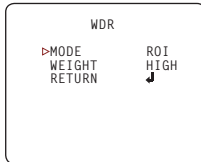
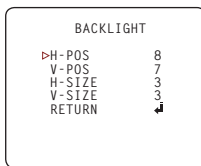
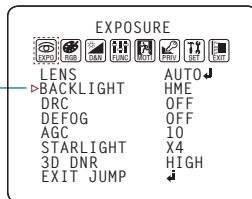

# OSD Menu\_Exposure

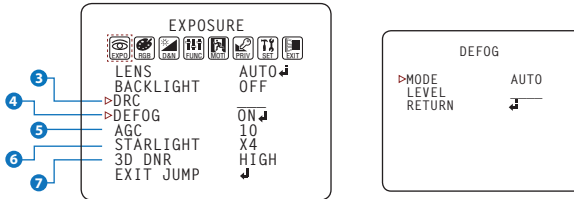

- 3 **DRC ( DYNAMIC RANGE COMPRESSOR )**  
DRC enables dark areas in images to become more visible without overexposing the bright areas to create one perfect image. Select from : OFF / LOW / MIDDLE / HIGH
- 4 **DEFOG**  
Allows the camera to process a scene that is obscured by fog or weather conditions and provides a visibly improved image. AUTO / Manual : Select AUTO to have the WDR and DRC levels adjusted automatically. Set the DEFOG level from LOW / MIDDLE / HIGH.
- 5 **AGC ( AUTO GAIN CONTROL )**  
0~10 - AGC enhances the picture brightness in low light conditions. A higher level AGC setting makes the images brighter, however, it could increase the amount of noise.
- 6 **STARLIGHT**  
OFF / x2 ~ x32(Default: X4) - Automatically activates slow shutter function when the image is too dark. High values are not recommended as they may causes the image to lag. Starlight menu cannot be controlled if the SHUTTER setting is above 1/30.
- 7 **3D DNR ( 3D DIGITAL NOISE REDUCTION )**  
OFF/LOW/MIDDLE/HIGH - 3D-DNR reduces the noise on the screen in low light conditions and allows for clearer images, even at night.

# OSD Menu\_Color

## WB MODE

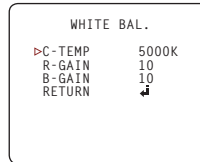
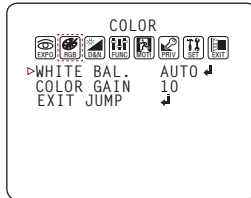

- AUTO** Auto Tracking White Balance Control mode compensates for color temperature changes between 2500K ° and 12000K ° .
- AUTO-EX** Auto White Balance Control mode compensates for color temperature changes lower than 2500K ° and tigher than 12000K ° .
- PRESET** Preset fixes the white balance based on the current lighting automatically.
- MANUAL** Users can control the white balance manually by changing RED GAIN and BLUE GAIN. (see blow) C-TEMP: Select the color temperature for the white balance setup. If enabled, the Red and Blue Gain settings will be set automatically according to the C-TEMP selected. RED GAIN: 0 ~ 20. Adjusts the amount of red in the image. BLUE GAIN: 0 ~ 20. Adjust the amount of blue in the image.
- COLOR GAIN** Set the color gain from 0~20.



# OSD Menu\_Day & Night

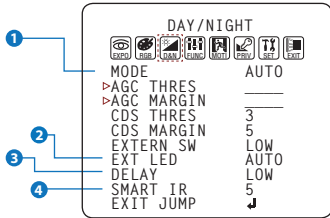

## 1 MODE

AUTO : Day/ Night switch will be based on the CDS levels.

COLOR : The camera always stays in day/color mode.

B&W : The camera always stays in night/B&W mode.

EXTERN : Day/ Night switch will be based on using IR LED lights.

\* WITHOUT LED

- AGC Threshold : Set when the camera switches between Day & Night.

- AGC Margin : Set the value added to the AGC Threshold. Adjust the value based on the environment in which the camera is installed. If the margin is too low, the camera will switch from color to B/W and back.

\* WITH LED

- CDS Threshold : Marks the light level at which the camera will switch between color and B/W.

The lower the value, the camera will require less light (more darkness) to switch to Night Mode.

- CDS Margin : The value added to the CDS Threshold. Adjust this based on the environment in which the camera is installed. If the margin is too low, the camera will switch from color to B/W and back.

## 2 EXT LED

AUTO : The LEDs are enabled/ disabled by the CDS Sensor on the LED Board.

OFF : The camera's LEDs are disabled manually.

## 3 DELAY

Low/Mid/High : Time interval delay before switching from day mode to night mode.

## 4 SMART IR

0 ~ 20 : Enable Smart IR and set the level. Higher values will make Smart IR stronger.

# OSD Menu\_Function

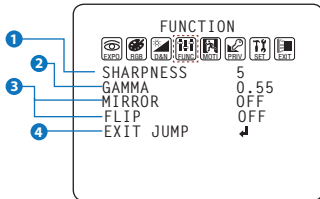

## 1 SHARPNESS

0 ~ 10 - Sets the image sharpness. The higher the number, the sharper the image.

## 2 GAMMA

0.45 ~ 0.75 - Select the desired gamma level. 0.55 is default setting.

## 3 MIRROR / FLIP

OFF

MIRROR : Reflects the camera horizontally.

FLIP : Reflects the camera vertically.



# OSD Menu\_Motion

The camera can detect movement and display an alarm on the screen. when movement is detected.

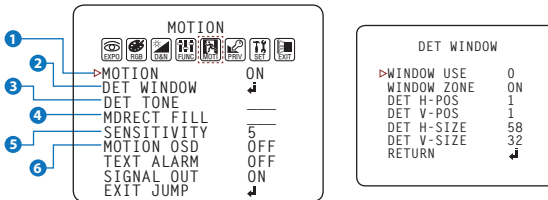

## 1 MOTION

To use the motion detection settings, be fore Motion is ON.

## 2 DET WINDOW

MOTION ZONE setting

## 3 DET TONE

Four each different motion tone color available

## 4 MDRECT FILL

Color setting for operating motion zone

## 5 SENSITIVITY

The smaller the movement you want to detect, the higher the sensitivity value must be.

## 6 MOTION OSD

MOTION ZONE display.

MOTION OSD interoperable with 'DET TONE' and 'MDRECT FILL'.

## 7 TEXT ALARM

Setup a text to appear on the screen when motion is detected explaining the alarm situation.

- WINDOW MOTION: Will appear when a motion alarm is detected.

- CAMERA MOVING : Will appear if the camera is shaken abruptly.

## 8 SIGNAL OUT (ON / OFF)

- ON : 'HIGH' SIGNAL OUT upon ALARM.

- OFF : 'SIGNAL OUT' off regardless of ALARM

# OSD Menu\_Privacy

You can hide some parts of the screen for privacy masking. A total of 16 different privacy masking zones are available. The cameras support square privacy masks or advanced polygon masks.

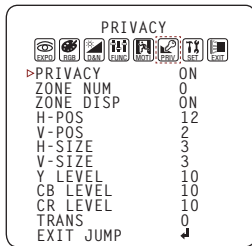

- ZONE NUM : Select the zone number between 0~15.
- ZONE DISP : Zone display ON/OFF
- H-POS : Move the Zone position Left or right. The higher the number, the zone will move to the right.
- V-POS : Move the Zone position up or down. The higher the number, the zone will move down.
- H-SIZE : Reset the zone's size horizontally. The higher the number, the right side panel will move further to the right.
- V-SIZE : Reset the zone's size vertically. The higher the number, the bottom side panel will move further down.
- Y LEVEL : The higher the number, the brighter the color will appear.
- CR LEVEL : The higher the number, the more red tone will be added to the zone's color.  
The lower the number, the more green will be added to the zone's color.
- CB LEVEL : The higher the number, the more red tone will be added to the zone's color.  
The lower the number, the more red will be added to the zone's color.
- \* High CB Level + High CR Level = Pink
- \* High CB Level + Low CR Level = Sky Blue
- \* Low CB Level + High CR Level = Orange
- TRANS : Set the mask's transparency level from 0~3. The default value is 0.

# OSD Menu\_Setup

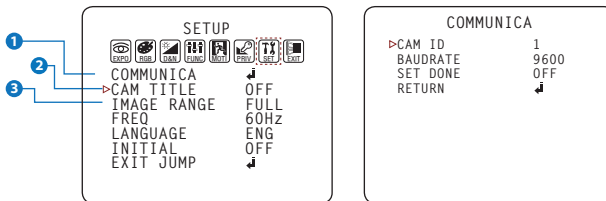

## 1 COMMUNICATION

Adjust the camera's ID and Baudrate. Default Protocol is Pelco-D.

- CAM ID : Provide an ID number for the camera (0 ~ 255).
- BAUDRATE : 9600bps is default. Select the baudrate from the following options :  
2400/4800/9600/57600/115200 bps.
- SET DONE : Set the value of CAM ID and BAUDRATE.

⊠ **NOTE** : Be sure to press "Save&Exit" button on the EXIT menu before saving.

## 2 CAM. TITLE

Add a name to the camera. Set the title by using the OSD joystick.

## 3 IMAGE RANGE

Image Range allows you to set the proper Black and White levels according to the external display you use.

- FULL : Display all BLACK level and WHITE level without compression.
- COMP : Display BLACK level and WHITE level with compression.
- USER : Reset the BLACK level by changing the OFFSET value.

# OSD Menu\_Setup

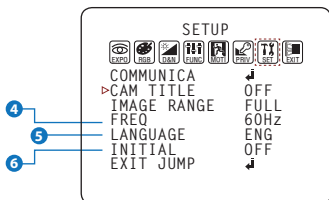

- 4** **FREQ**  
When the camera's image appears to have flickering issues, change the frequency value to adjust the image.
- 5** **LANGUAGE**  
Select from the following: English (Default), Chinese, Chinese (S), Japanese, and Koran.
- 6** **INITIAL**  
Reset the camera to its default settings. Press and hold the select button for five (5) seconds.

# OSD Menu\_EXIT

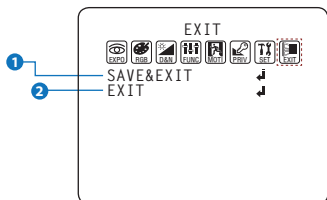

- 1 SAVE & EXIT**  
Exit the OSD menu after saving the recent changes.
- 2 EXIT**  
Exit the OSD menu without saving any changes.

# Troubleshooting

Before sending your camera for repair, check the following or contact our technical specialist.

## **FOR NO VIDEO**

Check the coaxial cable and make sure it is connected securely.

Check the power supply and make sure the camera has the proper voltage and current.

## **FOR OUT-OF-FOCUS VIDEO**

Check the clear dome cover and the lens for dirt or fingerprints. Use a soft cloth and gently clean.

The use of a field test monitor is recommended.



# Specifications

VIDEO	
Image Sensor	1/3" CMOS Sensors
Active Pixels	1944(H) x 1092(V)
Scanning System	Progressive scan
Frequency	60Hz / 50Hz
Signal Technology	2.0 Megapixel Universal
Synchronization	Internal
Resolution	1920x1080 (1080p30fps)
Minimum Scene Illumination	F2.0 (30IRE): 0.06 Lux (Color)
	F2.0 (30IRE): 0 Lux (B&W)
S/N Ratio	55dB
Video Output	BNC (Universal : HD-A/HD-TVI/HD-CVI/CVBS)
LENS	
Focal Length & Lens Type	3.6mm (F2.0)fixed
IR Distance	50ft
OPERATIONAL	
Shutter Speed	1/30(25) - 1/30,000
Backlight	OFF/HME/BLC/WDR
Starlight	OFF, x2 - x32
Wide Dynamic Range (WDR)	OFF/LOW/MIDDLE/HIGH

# Specifications

<b>OPERATIONAL (CONT.)</b>	
Digital Noise Reduction	OFF / LOW / MIDDLE / HIGH
White Balance	AUTO / AUTO-EX / PRESET / MANUAL
Day and Night	AUTO/COLOR/B&W/EXTERN
Auto Gain Control	0 ~ 10
Motion Detection	ON/OFF (4 Zones)
Privacy Zones	ON/OFF (16 Zones)
Sharpness	0 ~ 10
Gamma	0.45 ~ 0.75
Remote Control	COAXIAL (UTC)
<b>ENVIRONMENTAL</b>	
Operating Temperature	-20°C ~ 50°C (-4°F ~ 122°F)
Operating Humidity	No more than 90% (Non-Condensing)
IP Rating	IP66
Other Certifications	FCC, CE, ROHS
<b>ELECTRICAL</b>	
Power Requirements	DC12V
Power Consumption	LED OFF : 1.7W, 142mA LED ON : 2.9W, 242mA
<b>MECHANICAL</b>	
Housing Material and Dimensions	Aluminum, 4.13 x 2.38 in (105 x 60.7mm)
Weight	0.77 lbs

## Limits & Exclusions

There are no express warranties except as listed. The warranter will not be liable for incidental or consequential damages (including damage to recording media without limitation) resulting from the use of these products or arising out of any breach of the warranty. All express and implied warranties, including the warranties of merchantability and fitness for particular purpose, are limited to the applicable warranty period set forth above.

Some states do not allow the exclusion or limitation of incidental or consequential damages, or limitations on how long an implied warranty lasts, so the exclusions or limitations listed above may not apply to you. This warranty gives you specific legal rights, and you may also have other rights that vary from state-to-state.

If the problem is not handled to your satisfaction, then write to the following address:

Digital Watchdog, Inc.  
ATTN: RMA Department  
5436 W. Crenshaw Street  
Tampa, FL 33634

Service calls which do not involve defective materials or workmanship as determined by the Warranter, in its sole discretion, are not covered. Costs of such service calls are the responsibility of the purchaser.

# Warranty Information

Digital Watchdog (referred to as “the Warranter”) warrants the Digital Watchdog Camera against defects in materials or workmanship as follows:

**LABOR:** For the initial five (5) years and one (1) year on IR LED from the original purchase date, if the camera is determined to be defective, the Warranter will repair or replace the unit with a new or refurbished product at its option at no charge.

**PARTS:** In addition, the Warranter will supply replacement parts for the initial five (5) years and one (1) year on IR LED.

To obtain warranty or out of warranty service, please contact a Technical Support Representative at 1+ (866)446-3595 Monday through Friday from 9:00AM to 8:00PM Eastern Standard Time.

A purchase receipt or other proof of the original purchase date is required before warranty service is rendered. This warranty only covers failures due to defects in materials and workmanship which arise during normal use. This warranty does not cover damage which occurs in shipment or failures which are caused by products not supplied by the Warranter or failures which result from accident, misuse, abuse, neglect, mishandling, misapplication, alteration, modification, faulty installation, set-up adjustments, improper antenna, inadequate signal pickup, maladjustment of consumer controls, improper operation, power line surge, improper voltage supply, lightning damage, rental use of the product or service by anyone other than an authorized repair facility or damage that is attributable to acts of God.

## Notes

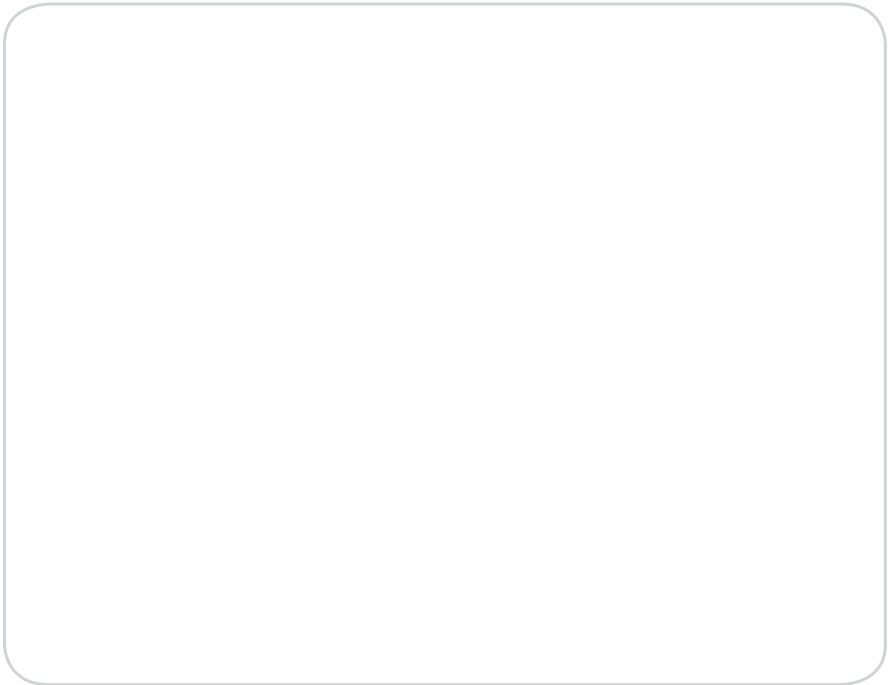

## Notes

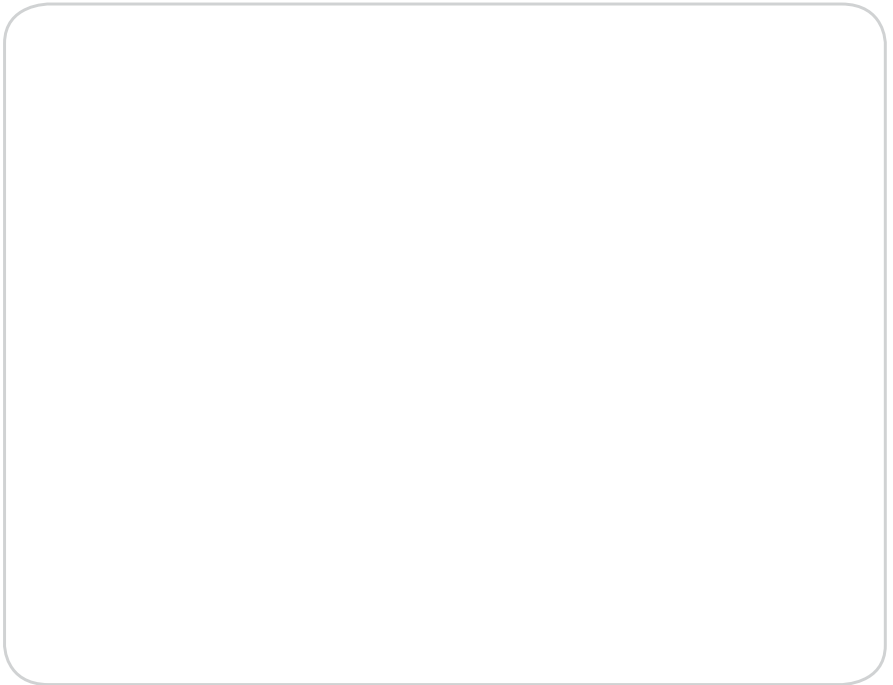

## Notes

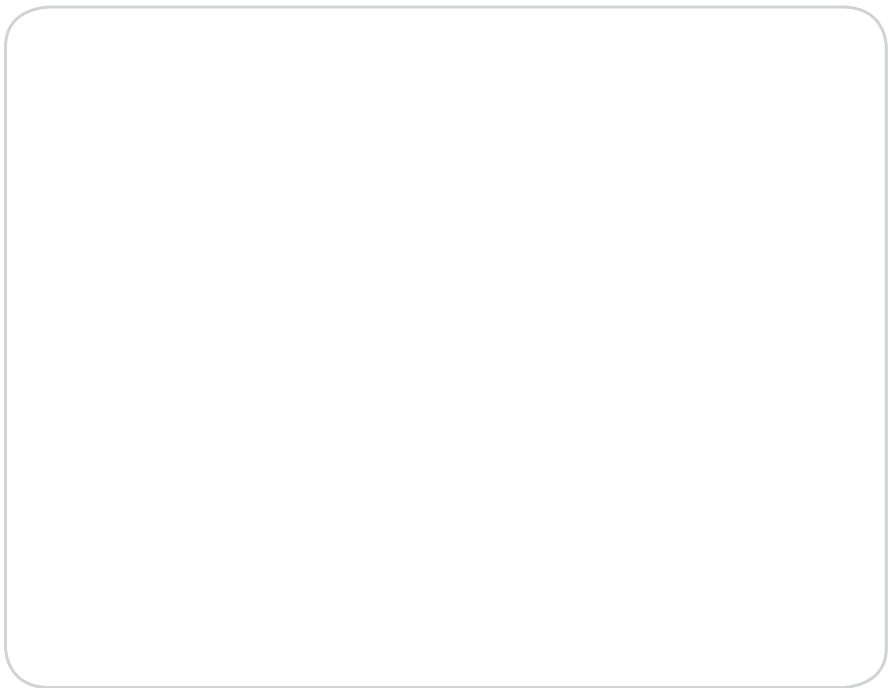



*Complete Surveillance Solutions*

East Coast Headquarters Office: 5436 W Crenshaw St, Tampa, FL 33634

West Coast Headquarters Office: 16220 Bloomfield Ave., Cerritos, CA 90703

PH: 866-446-35951 FAX: 813-888-9262

[www.Digital-Watchdog.com](http://www.Digital-Watchdog.com) Technical Support:

USA & Canada 1+ (866) 446-3595

International 1+ (813) 888-9555

French Canadian 1+ (514) 360-1309

Support Hours: Monday-Friday 9:00am to 8:00pm EST