

L1300FD DSP power amplifier 2x650W



- Live performance DSP amplifier
- Fully integrated professional speaker processing with FIR Drive technology
- Market leading acoustic performance and rock solid reliability
- True 2 ohm stability
- Intuitive system control software, makes setup and control easy

Technical specifications

Load Impedance	2 Ω	2.6 Ω	4 Ω	8 Ω
Maximum Output Power, Single Channel	1100 W	950 W	660 W	350 W
Maximum Output Power, Dual Channel	1000 W	850 W	600 W	320 W
Maximum Output Power, Bridged	-	-	2000 W	1200 W
Maximum RMS Voltage Swing THD = 1%, 1 kHz	55.3 V			
Voltage Gain Ref. 1 kHz	32.0 dB			
THD at 450 W/4 Ω MBW = 80 kHz, 1 kHz	< 0.05%			
IMD-SMPTE, 60 Hz, 7 kHz	< 0.1%			
DIM30, 3.15 kHz, 15 kHz	< 0.05%			

Maximum Input Level	+21 dBu
Crosstalk ref. 1 kHz, at 100 W/4 Ω	< -80 dB
Frequency Response, ref. 1 kHz	10 Hz to 21 kHz (± 1 dB)
Input Impedance, Active Balanced	20 k Ω
Signal to Noise Ratio Amplifier, A-weighted, ref to Max. Output Power @ 8 Ω	> 104 dB
Output Noise, A-weighted	< -68 dBu
Output Stage Topology	Class AB
Power Requirements	240 V, 230 V, 120 V or 100 V; 50 Hz to 60 Hz (factory configured)

Power Consumption 1/8 Maximum Output Power @ 4 Ω	550 W
Mains Fuse	240 V/230 V: T10AH; 120 V/100 V: T20AH
Protection	Audio limiters, high temperature, DC, HF, Back-EMF, Peak current limiters, Inrush current limiters, Turn on delay
Cooling	Front-to-rear, 3-stage-fans
Ambient Temperature Limits	+5°C to +40°C (40°F to +105°F)
Safety Class	I
Color	Black
Dimensions (W x H x D), mm	483 x 88 x 462.4
Weight	12.9 kg (28.4 lb)
Signal Processing	FIR Filters, Audio Limiters Output delay per channel, 31 band GEQ per channel, PEQ per channel, Load impedance
Accessories	RMK15 (rear rack mount kit), Multi Amplifier Remote Control (MARC) software

Test signal for max. output power according IHF-A-202 (Dynamic-Headroom, burst 1 kHz/20 ms on/480 ms off/low level -20 dBu).

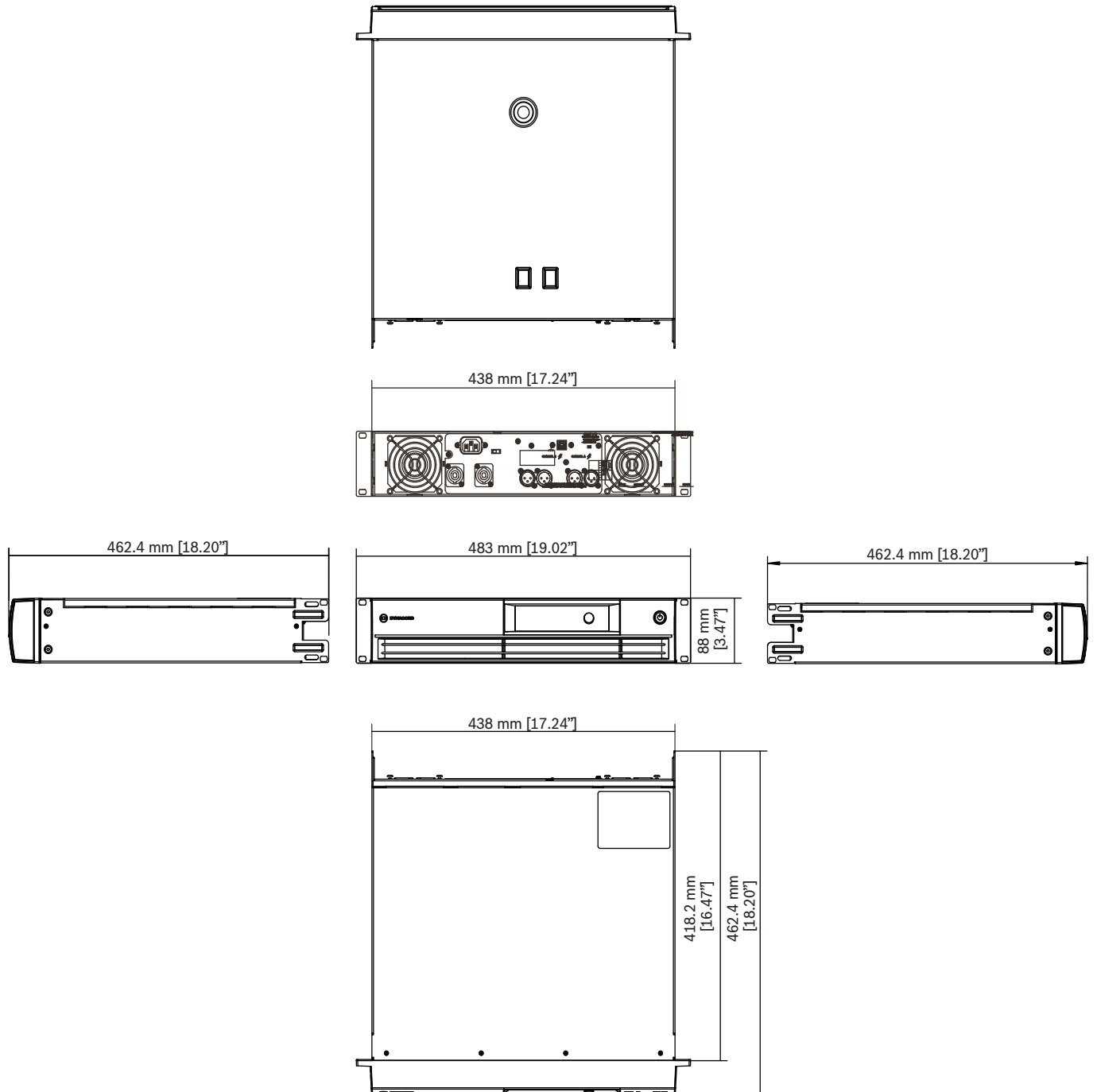

Dimensions

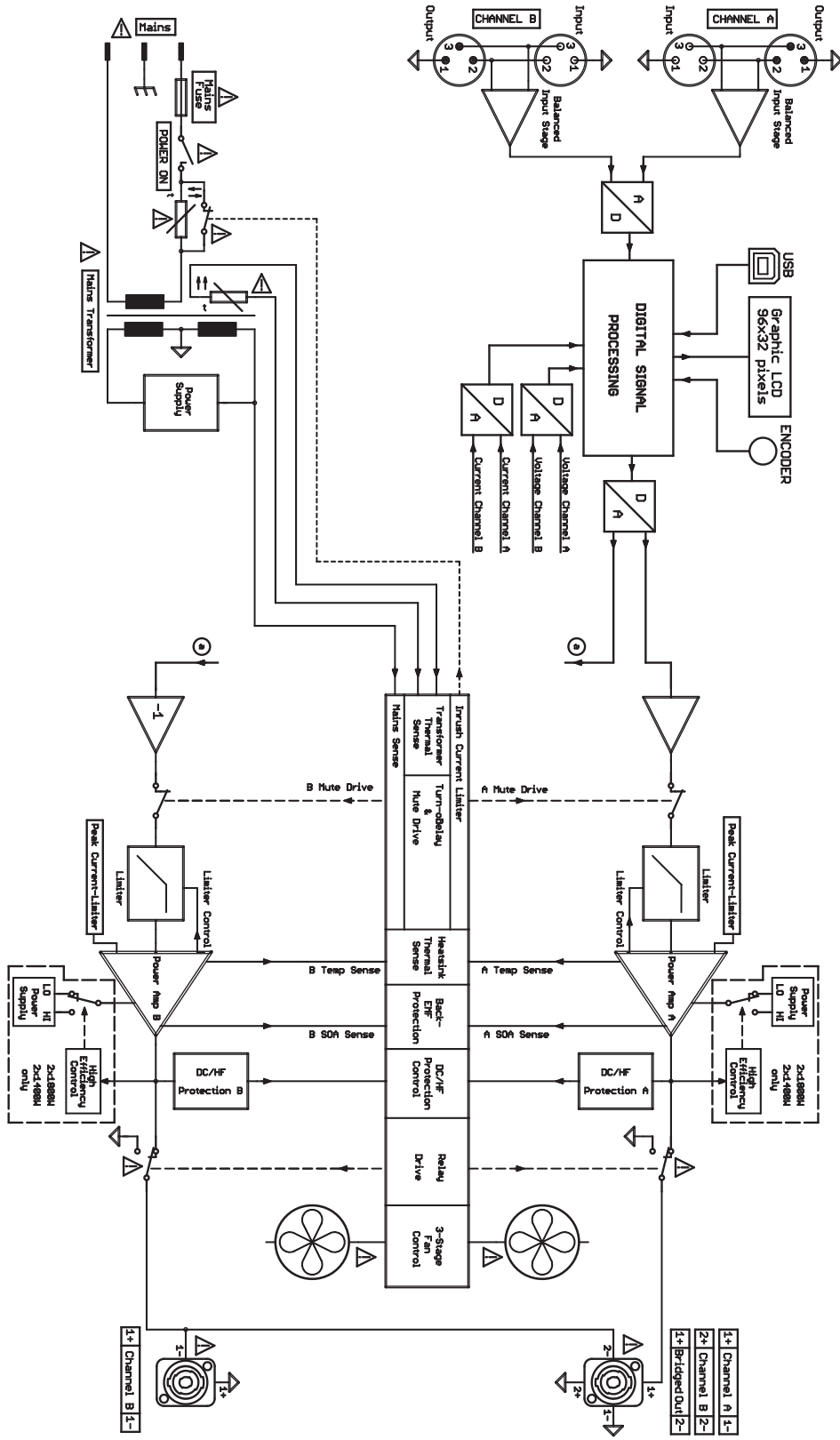

SAFETY COMPONENT MUST BE REPLACED BY ORIGINAL PARTS

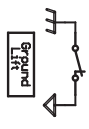

Block diagram

Ordering information

L1300FD-AU DSP power amplifier 2x650W AU

DSP power amplifier 2 x 660W @ 4 ohms with FIR
Drive, black, Australian region
Order number **L1300FD-AU**

L1300FD-CN DSP power amplifier 2x650W CN

DSP power amplifier 2 x 660W @ 4 ohms with FIR
Drive, black, Chinese region
Order number **L1300FD-CN**

L1300FD-EU DSP power amplifier 2x650W EU

DSP power amplifier 2 x 660W @ 4 ohms with FIR
Drive, black, European region
Order number **L1300FD-EU**

L1300FD-JP DSP power amplifier 2x650W JP

DSP power amplifier 2 x 660W @ 4 ohms with FIR
Drive, black, Japanese region
Order number **L1300FD-JP**

L1300FD-UK DSP power amplifier 2x650W UK

DSP power amplifier 2 x 660W @ 4 ohms with FIR
Drive, black, UK region
Order number **L1300FD-UK**

L1300FD-US DSP power amplifier 2x650W US

DSP power amplifier 2 x 660W @ 4 ohms with FIR
Drive, black, North American region
Order number **L1300FD-US**

DC-RMK15 RMK-15

Rack Mount Kit for amplifiers, Length 15,5"; 1L/1R
Order number **DC-RMK15**

Germany:

Bosch Sicherheitssysteme GmbH
Robert-Bosch-Ring 5
85630 Grasbrunn
Germany

Bosch Security Systems, Inc.
130 Perinton Parkway
Fairport, NY 14450
USA

www.dynacord.com