

# *ProHD*

MULTI FORMAT LCD MONITOR

## **DT-N21F**

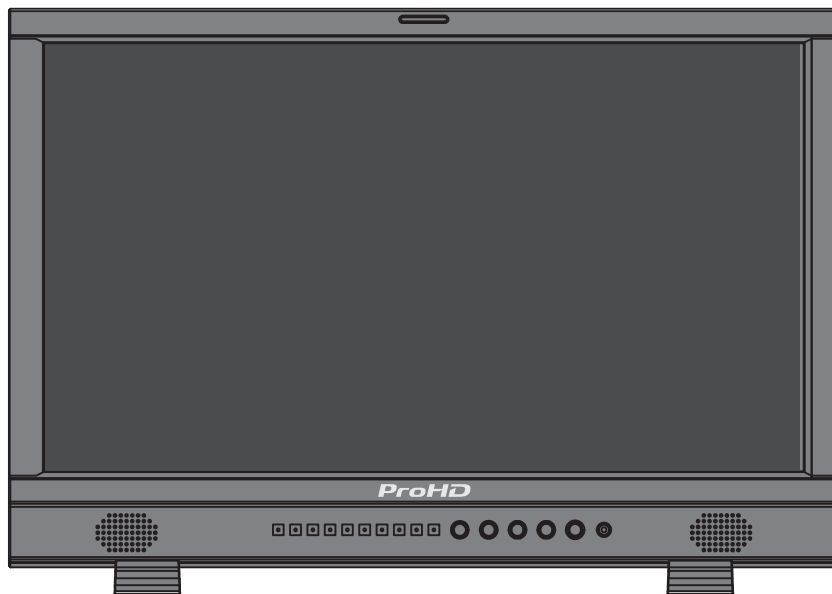

INSTRUCTIONS



**For Customer Use:**

Please read the Instruction Manual carefully and retain this information for future reference.

# Safety Precautions

 <b>CAUTION</b> <b>RISK OF ELECTRICAL SHOCK</b> <b>DO NOT OPEN</b> 	<p>The lightning flash with arrowhead symbol, within an equilateral triangle is intended to alert the user to the presence of uninsulated "dangerous voltage" within the product's enclosure that may be of sufficient magnitude to constitute a risk of electric shock to persons.</p> <p>The exclamation point within an equilateral triangle is intended to alert the user to the presence of important operating and maintenance (servicing) instructions in the literature accompanying the appliance.</p>
---	---

**CAUTION:** To reduce the risk of electric shock. Do not remove cover (or back). No user serviceable parts inside. Refer servicing to qualified service personnel.

**WARNING:** TO REDUCE RISK OF FIRE OR ELECTRIC SHOCK, DO NOT EXPOSE THIS APPARATUS TO RAIN OR MOISTURE. NO OBJECTS FILLED WITH LIQUIDS, SUCH AS VASES, SHALL BE PLACED ON THE APPARATUS.

**Warning:** This is a class A product. In a domestic environment this product may cause radio interference in which case the user may be required to take adequate measures.

## IMPORTANT SAFEGUARDS

Electrical energy can perform many useful functions. This unit has been engineered and manufactured to assure your personal safety. But **IMPROPER USE CAN RESULT IN POTENTIAL ELECTRIC SHOCK OR FIRE**. In order not to defeat the safeguards incorporated into this product, observe the following basic rules for its installation, use, and service. Please read these "IMPORTANT SAFEGUARDS" carefully before use.

- All the safety and operating instructions should be read before the product is operated.
- The safety and operating instructions should be retained for future reference.
- All warnings on the product and in the operating instructions should be adhered to.
- All operating instructions should be followed.

## POWER CONNECTION

The power supply voltage rating of this product is AC 120 V (For U.S.A. and Canada) and AC 220 -240 V (For Europe and Asia).

The power cord attached conforms to the following power supply voltage and countries. Use only the power cord designated to ensure safety and EMC regulations of each country.

Not all types of power cords are supplied to this product.

For U.S.A. and Canada: AC 120V For Europe and Asia: AC 220-240V



This plug will fit only into a grounded power outlet. If you are unable to insert the plug into the outlet, contact your electrician to install the proper outlet. Do not defeat the safety purpose of the grounded plug.

This product should be operated only with the type of power source indicated on the label. If you are not sure of the type of power supply of your home, consult your product dealer or local electric power company.

- Before connecting other products such as VCR's and personal computers, you should turn off the power of this product for protection against electric shock.
- Do not use attachments not recommended by the manufacturer as they may be hazardous.
- **When replacement parts are required**, be sure the service technician has used replacement parts specified by the manufacturer or equivalents. Unauthorized substitutions may result in fire, electric shock, or other hazards.
- **Upon completion of any service or repairs to this product**, ask the service technician to perform safety checks to determine that the product is in proper operating condition.

- Do not install this product in the following places:
  - in a damp or dusty room
  - where the product is exposed to soot or steam, such as near the cooking counter or a humidifier
  - near heat sources
  - where condensation easily occurs, such as near the window
  - in a location exposed to direct sunlight or strong light
- Do not place this product on an unstable cart, stand, or table. The product may fall, causing serious injury to a child or adult, and serious damage to the product. The product should be mounted according to the manufacturer's instructions, and should use a mount recommended by the manufacturer.
- Do not use this product near water.
- Be sure to install the product in the place where proper temperature and humidity are kept (see "Operating conditions" on page 19). This product becomes hot during its use. Take enough care when handling the product.

## Under the following conditions,

1. Turn off the power.
2. Unplug this product from the wall outlet.
3. Refer service to qualified service personnel.
  - a) When the product emits smoke or unusual smell.
  - b) When the product exhibits a distinct change in performance —for example, no picture or no sound.
  - c) If liquid has been spilled, or objects have fallen on the product.
  - d) If the product has been exposed to rain or water.
  - e) If the product has been dropped or damaged in any way.
  - f) When the power supply cord or plug is damaged.

# Safety Precautions (cont.)

Do not attempt to service this product yourself, as opening or removing covers may expose you to dangerous voltages and other hazards. Refer all service to qualified service personnel.

Do not use the product for a long time if the sound is distorted.

Use only the power source specified on the unit.

- AC power: 120 V/220 - 240V, 50 Hz/60 Hz
- DC power: 11V-17V

- When the product is left unattended and unused for a long period of time, unplug it from the wall outlet and disconnect the cable system.
- Do not overload wall outlets, extension cords, or convenience receptacles on other equipment as this can result in a risk of fire or electric shock.

- Slots and openings in the cabinet are provided for ventilation. These ensure reliable operation of the product and protect it from overheating. These openings must not be blocked or covered.
- Never push objects of any kind into this product through openings as they may touch dangerous voltage points or short-circuit the parts, which could result in a fire or electric shock.
- Never spill liquid of any kind on the product.
- Never place anything on the product. (Placing liquids, naked flames, cloths, paper, etc. on the product may cause a fire.)
- Do not apply any strong shock to the LCD panel. (Do not hit any object against it or push it with a sharp-pointed tool.)
- Do not put heavy objects on the product.
- Do not step on or hang on the product.

# Safety Precautions (cont.)

## IMPORTANT SAFETY INSTRUCTIONS

- 1) Read these instructions.
- 2) Keep these instructions.
- 3) Heed all warnings.
- 4) Follow all instructions.
- 5) Do not use this apparatus near water.
- 6) Clean only with dry cloth.
- 7) Do not block any ventilation openings. Install in accordance with the manufacturer's instructions.
- 8) Do not install near any heat sources such as radiators, heat registers, stoves, or other apparatus (including amplifiers) that produce heat.
- 9) Do not defeat the safety purpose of the polarized or grounding-type plug. A polarized plug has two blades with one wider than the other. A grounding type plug has two blades and a third grounding prong. The wide blade or the third prong are provided for your safety. If the provided plug does not fit into your outlet, consult an electrician for replacement of the obsolete outlet.
- 10) Protect the power cord from being walked on or pinched particularly at plugs, convenience receptacles, and the point where they exit from the apparatus.
- 11) Only use attachments/accessories specified by the manufacturer.
- 12) Use only with the cart, stand, tripod, bracket, or table specified by the manufacturer, or sold with the apparatus. When a cart is used, use caution when moving the cart/apparatus combination to avoid injury from tip-over.
- 13) Unplug this apparatus during lightning storms or when unused for long periods of time.
- 14) Refer all servicing to qualified service personnel. Servicing is required when the apparatus has been damaged in any way, such as power-supply cord or plug is damaged, liquid has been spilled or objects have fallen into the apparatus, the apparatus has been exposed to rain or moisture, does not operate normally, or has been dropped.
- 15) Apparatus shall not be exposed to dripping or splashing and no objects filled with liquids, such as vases, shall be placed on the apparatus.
- 16) Batteries shall not be exposed to excessive heat such as sunshine, fire or the like.
- 17) When discarding batteries, environmental problems must be considered and the local rules or laws governing the disposal of these batteries must be followed strictly.



## Operating Precautions

The LCD panel and backlight have life expectancy. Due to the basic characteristics of the LCD panel, an afterimage or uneven display may occur. It is recommended that you change images occasionally, activate the power saving function, or often turn off the power to reduce the load on the LCD panel. Continuous operations of the LCD panel may accelerate the deterioration.

### ● Maintenance

**Unplug this product from the wall outlet before cleaning.**

#### LCD panel

To avoid irreparable change in appearance of the screen such as uneven color, discoloration, scratches, be careful about the following:

- Do not paste or stick anything using any glues or adhesive tapes.
- Do not write anything on the screen.
- Do not strike the screen with a hard object.
- Avoid condensation on the screen.
- Do not wipe the screen with any liquid such as water. In addition, wiping the screen with water-diluted neutral detergent or solvent such as alcohol, thinner, or benzene may affect the anti-reflection treatment of the screen.
- Do not wipe the screen forcefully.

Wipe stains off the LCD panel with a soft cloth. If the screen gets heavily stained, wipe it with a soft cloth soaked in water-diluted neutral detergent and wrung well, then wipe with a soft dry cloth.

#### Cabinet

To avoid the deterioration or damages of the cabinet such as its paint's peeling away, be careful about the following:

- Do not wipe the cabinet using solvent such as alcohol, thinner, or benzene.
- Do not expose the cabinet to any volatile substance such as insecticides.
- Do not allow any rubber or plastic in contact for a long time.
- Do not wipe the cabinet forcefully.

Wipe stains off the cabinet with a soft cloth. If the cabinet gets heavily stained, wipe it with a soft cloth soaked in water-diluted neutral detergent and wrung well, then wipe with a soft dry cloth.

#### Ventilation openings

Use a vacuum cleaner to get rid of the dust around the intakes (all the openings). If a vacuum cleaner is not available, use a cloth and wipe it off. Leaving the dust around the intakes may prevent proper temperature control and cause damage to the product.

# Table of Contents

Safety Precautions .....	2
IMPORTANT SAFEGUARDS .....	2
Operating Precautions .....	4
Caution for use of the product in the high temperature .....	4
Maintenance .....	4
Installation .....	6
Index of Parts and Functions .....	7
Rear panel .....	7
Front panel .....	8
Showing Input Signals .....	9
Volume Adjustment/Audio Channel Selection .....	9
On the Information Display .....	9
On the Status Display .....	9
Menu Configuration .....	10
The operation procedure .....	10
Menu Transition Diagram .....	10
Main Menu .....	11
External Control .....	18
About the external control .....	18
Using the UMD control .....	18
Using the GPI control .....	18
Troubleshooting .....	19
Specifications .....	20
General .....	20
LCD panel .....	20
Input/output terminals .....	20
Dimensions .....	21
Available signals .....	22

# Installation

- Do not rest your arm on the monitor or lean against the monitor.
- Do not touch the LCD panel when installing the monitor.
- Be sure to install the monitor securely to prevent the monitor from falling over, which may cause damage to the monitor or injury.

● **To install the monitor on a shelf or any other suitable surface using screws**

- 1 Lay the monitor on a cloth with the LCD panel facing down to prevent the LCD panel from being damaged.**
- 2 Take out the desktop stand (2 feet) from accessory box in the package.**
- 3 Clockwise screw the feet onto the bottom of the monitor.**

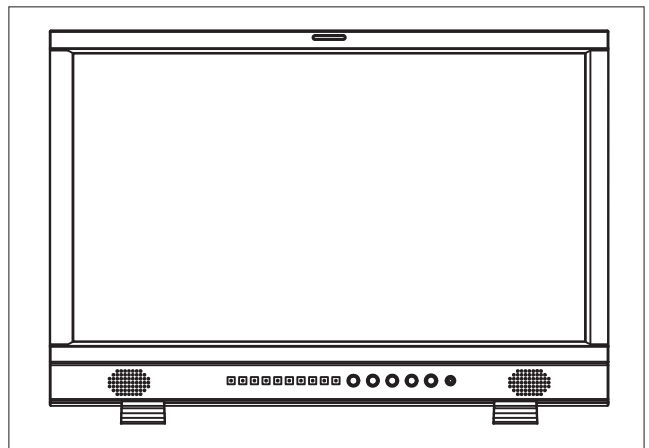
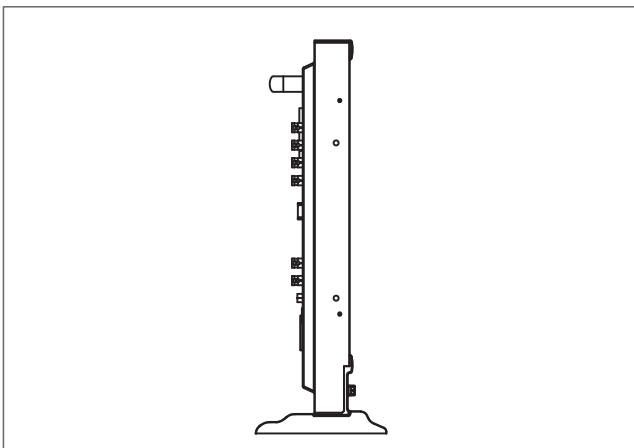
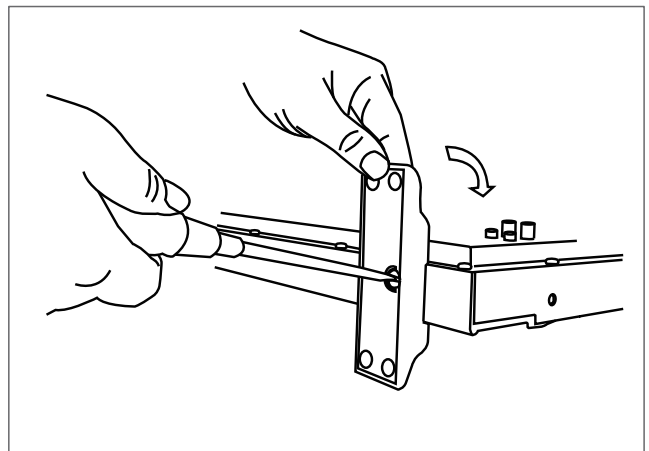
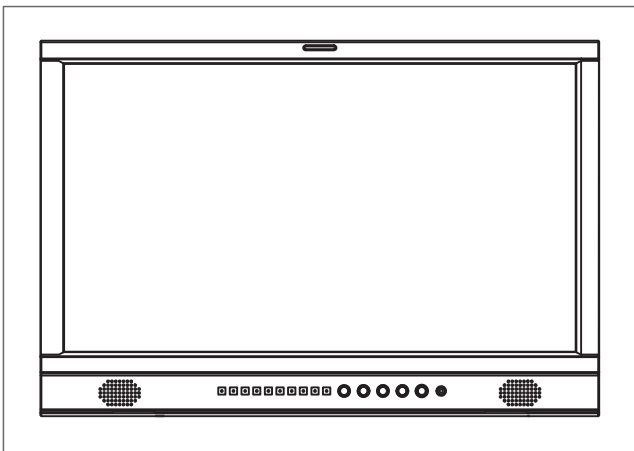

# Index of Parts and Functions

## Rear panel

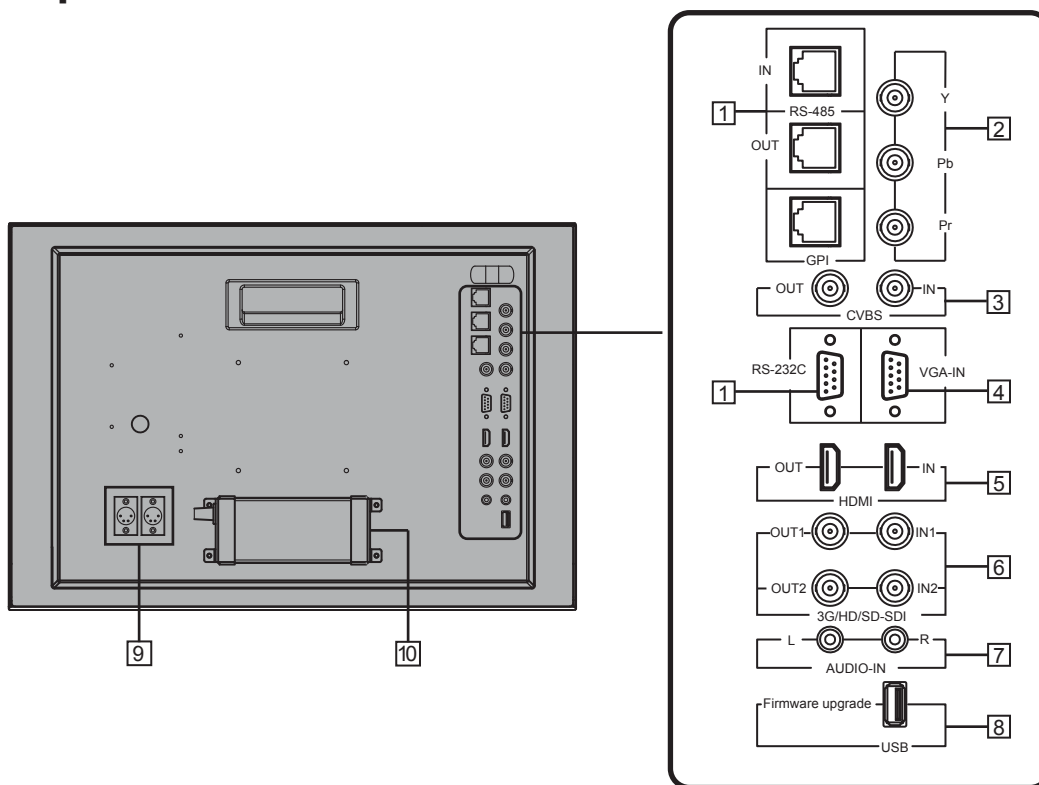

- 1 **REMOTE terminal**  
Terminal for controlling the monitor by an external control (☞ “External Control” on page 18 ).
- 2 **Y / Pb / Pr (IN) terminals (BNC)**
- 3 **CVBS terminals (BNC)**  
Input (IN) and output (OUT) terminals for the composite signals.
- 4 **VGA-IN (mini D-sub 15pin)**  
Input terminal for analog RGB signal. (☞ page 23)
- 5 **HDMI terminal**  
Input / Output terminal for HDMI signals. The monitor will not display or output HDMI with HDCP protection. (☞ page 23)
- 6 **E. AUDIO 3G/HD/SD SDI (IN 1, IN 2) terminals (BNC)**  
Input / Output terminals for the HD/SD SDI signals.  
● The terminals accept also EMBEDDED AUDIO signals including up to 16 audio channels with a sampling frequency of 48 kHz.
- 7 **AUDIO (IN) terminals (pin jack)**  
Input terminals for the analog audio signals.  
● Set signal source as ANALOG (CVBS, VGA, YPbPr) ,the analog audio can be monitored as audio meters or output via Speaker/Headphone.
- 8 **USB socket**  
Download new firmware to a USB stick, and insert into this socket. By menu operating, the monitor firmware can be upgraded.
- 9 **DC-IN terminal**  
Main (Back up) power input, connect with DC11V ~17V 4-pin XLR power adapter. (Pin 1: Negative, Pin 4: Positive)
- 10 **AC-IN terminal**  
AC power input connector.  
Connect the provided AC power cord to an AC outlet.

### CAUTION

Do not connect the power cord until all other connections are completed.

### Note for connections

- Before making any connections, turn off all the equipment.
- Use a cord whose plugs correctly match the terminals on this monitor and the equipment.
- Plugs should be firmly inserted; poor connections could cause noise.
- When unplugging a cord, be sure to grasp its plug and pull it out.
- DO NOT connect the power cord until all connections are complete.
- Refer also to the user manual of each piece of equipment.

# Index of Parts and Functions (cont.)

## Front panel

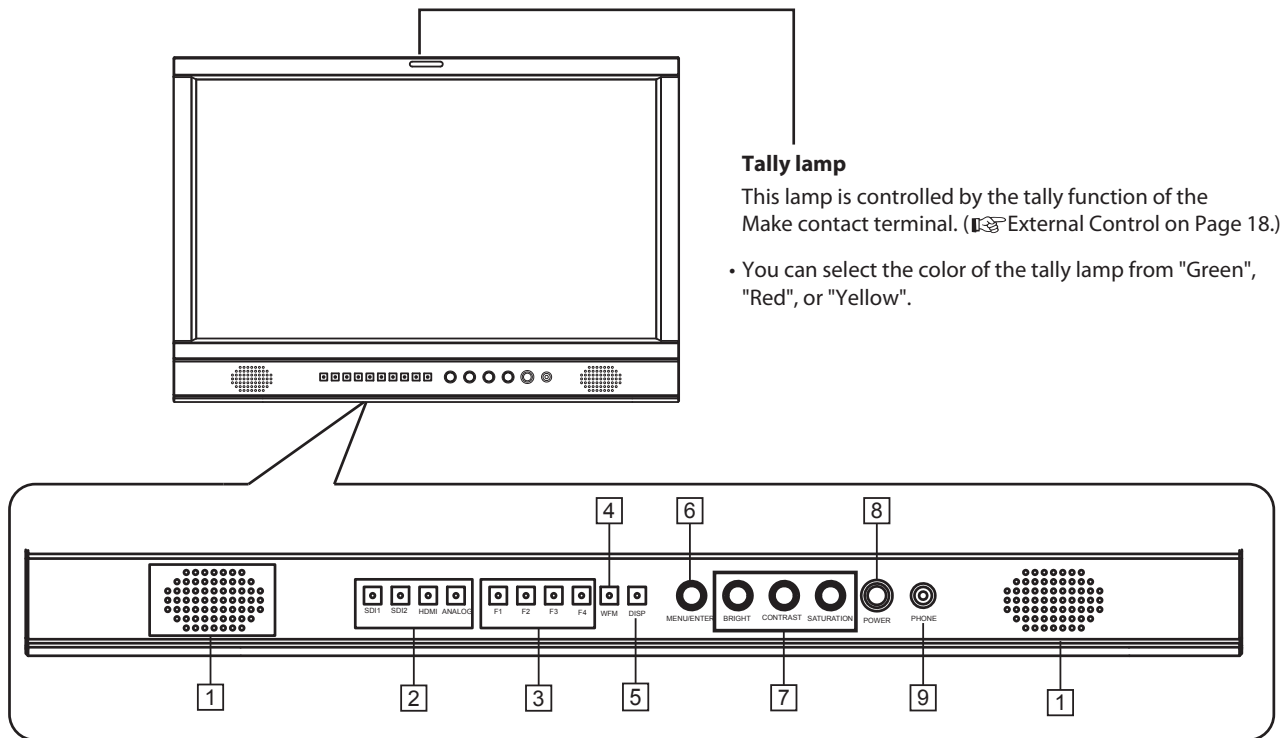

### Tally lamp

This lamp is controlled by the tally function of the Make contact terminal. (External Control on Page 18.)

- You can select the color of the tally lamp from "Green", "Red", or "Yellow".

### 1 Speaker:

For SDI/HDMI embedded audio and analog audio monitoring. (Will not work if earphone is plugged in)

### 2 INPUT SELECT buttons/lamps

Selects an input.

SDI 1: E. AUDIO 3G/HD/SD SDI (IN 1) terminal

SDI 2: E. AUDIO 3G/HD/SD SDI (IN 2) terminal

HDMI:HDMI terminal

ANALOG: select from CVBS, VGA, Y/ Pb / Pr signal

- The lamp for the selected input lights

### 3 FUNCTION button

You can use the functions assigned to this button.

### 4 WFM button

Waveform shortcut key, press "WFM" to quickly turn on or turn off the waveform, and select the type of the waveform.

### 5 DISP button

Press "INFO ON/OFF" to turn on or turn off relevant status information, audio and video waveform.

### 6 VOLUME MENU/PUSH

When the menu is inactivated, press "VOLUME MENU/PUSH" to turn on the main menu

Revolve "VOLUME MENU/PUSH" to adjust settings or parameters, and press to apply

When the menu is inactivated, revolve "VOLUME MENU/PUSH" to adjust the sound volume

### 7 Picture adjustment knob

BRIGHT: Adjusts the picture brightness and the default value is 50.

CONTRAST: Adjusts the picture contrast and the default value is 50.

SATURATION: Adjusts the picture saturation and the default value is 50.

\* Directly press BRIGHT/CONTRAST/SATURATION knobs, the parameters will recover to default value.

### 8 POWER

Turns on and off the monitor.

### 9 PHONE

3.5mm earphone socket, for SDI/HDMI embedded audio and analog audio monitoring.



# Showing Input Signals

## Volume Adjustment

- 1 When no menu screen is not displayed, revolve the "VOLUME MENU/PUSH" button
- 2 Clockwise revolve "VOLUME MENU/PUSH" knob to volume up, and anticlockwise revolve to volume down. The volume value range is 0-31.
- 3 Press the "VOLUME MENU/PUSH" button to finish.  
The "Volume" screen disappears automatically if no operations are made for 3 seconds.

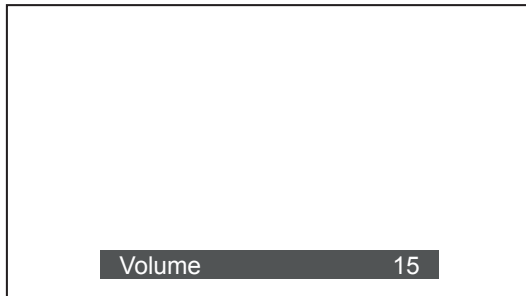

## On the Information Display

### 1 Time code (SDI)

Under SDI input, it can display Time code. If no Time code information is detected, it will be displayed as "TC UNLOCKED". User can set function keys F1 ~ F4 or GPI pins as "Time code" to turn on or off this function.

### 2 UMD

Set up the UMD under "UMD" submenu.

### 3 AFD (SDI)

User can set function keys F1 ~ F4 or GPI pins as "AFD" to turn on or off this function. If no relevant information is detected, it will be displayed as "AFD: UNLOCKED".

### 4 Audio Bar

Monitor the audio information. The relevant parameters like position, audio channels and blending, etc. can be changed under "Audio Bar" submenu. User can set function Keys F1 ~ F4 or GPI pins as "Audio Bar" to turn on or off this function.

### 5 Histogram

User can set function Keys F1 ~ F4 or GPI pins as "Histogram" to turn on or off this function.

### 6 Vector

The relevant parameters like Vector position, Vector color and Vector blending, etc. can be changed under "Vector" submenu. User can set function Keys F1 ~ F4 or GPI pins as "Vector" to turn on or off this function.

### 7 Waveform

Press "WFM" on the front panel to turn on/of this function. The relevant parameters like WFM position, WFM color and WFM blending, etc. can be changed under "Waveform" submenu.

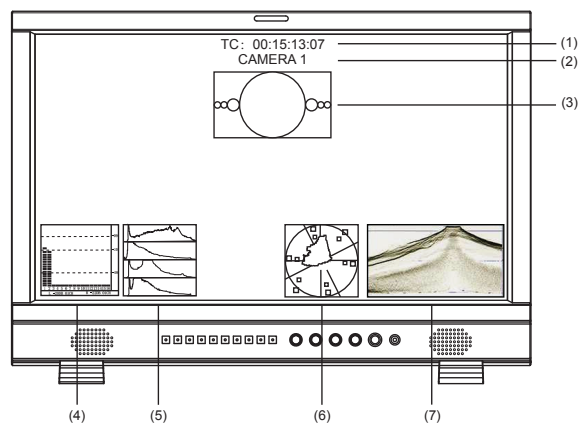

## On the Status Display

Press "VOLUME MENU/PUSH" button, the main menu will pop up from the left top of the screen, to display the current working status, including:

1. Current input video format.  
If no video input is locked, it will display "No Signal".
2. User profile. The monitor can restore 3 user preference settings.
3. Color temperature value.
4. Scan mode.
5. Freeze Frame mode status.
6. Odd/Even Frame mode status.  
Not available if the current input signal doesn't support Odd/Even mode.
7. The Function Key 1 setting.
8. The Function Key 2 setting.
9. The Function Key 3 setting.
10. The Function Key 4 setting.
11. Current firmware version.

Main Menu	Status	
Exit&Status >	HDMI	XXX 1
Picture >	User Profile	XX 2
Color Temp >	Color Temp	XXXX 3
Function Key >	Scan Mode	XXX 4
GPI >	Freeze Frame	XXX 5
UMD >	Odd/Even Frame	XXX 6
Marker >	F1	XXX 7
Audio >	F2	XXX 8
Vector >	F3	XXX 9
Waveform >	F4	XXX 10
Display >	F5	XXX
System >	System Version	XXX 11
Color Measurement >		
OSD >		
Key Inhibit >		

# Menu Configuration

## The Operation Procedure

- 1 Press the MENU button to display the Main Menu
- 2 Revolve "VOLUME MENU/PUSH" to select submenu, the selected submenu highlights in yellow, press "VOLUME MENU/PUSH" to apply and enter into the selected submenu's items
- 3 Revolve "VOLUME MENU/PUSH" to select the item which needed to adjust, press "VOLUME MENU/PUSH", the selected item and its parameters will be highlighted in yellow.
- 4 Revolve "VOLUME MENU/PUSH" to change the selected item's parameter, press "VOLUME MENU/PUSH" to apply and save the settings.
- 5 Revolve "VOLUME MENU/PUSH" to select "Exit", press "VOLUME MENU/PUSH" to quit submenu. Select "Exit & Status" under the Main Menu and press to quit Main Menu.

**Notice:**

- The items in gray cannot be set up.
- If there is no operation under the set time, the menu will automatically save settings and quit.
- If the key inhibit function is turned on, except key inhibit function, all other items are in grey. Please turn off the key inhibit function to adjust the items.

## Menu Transition Diagram

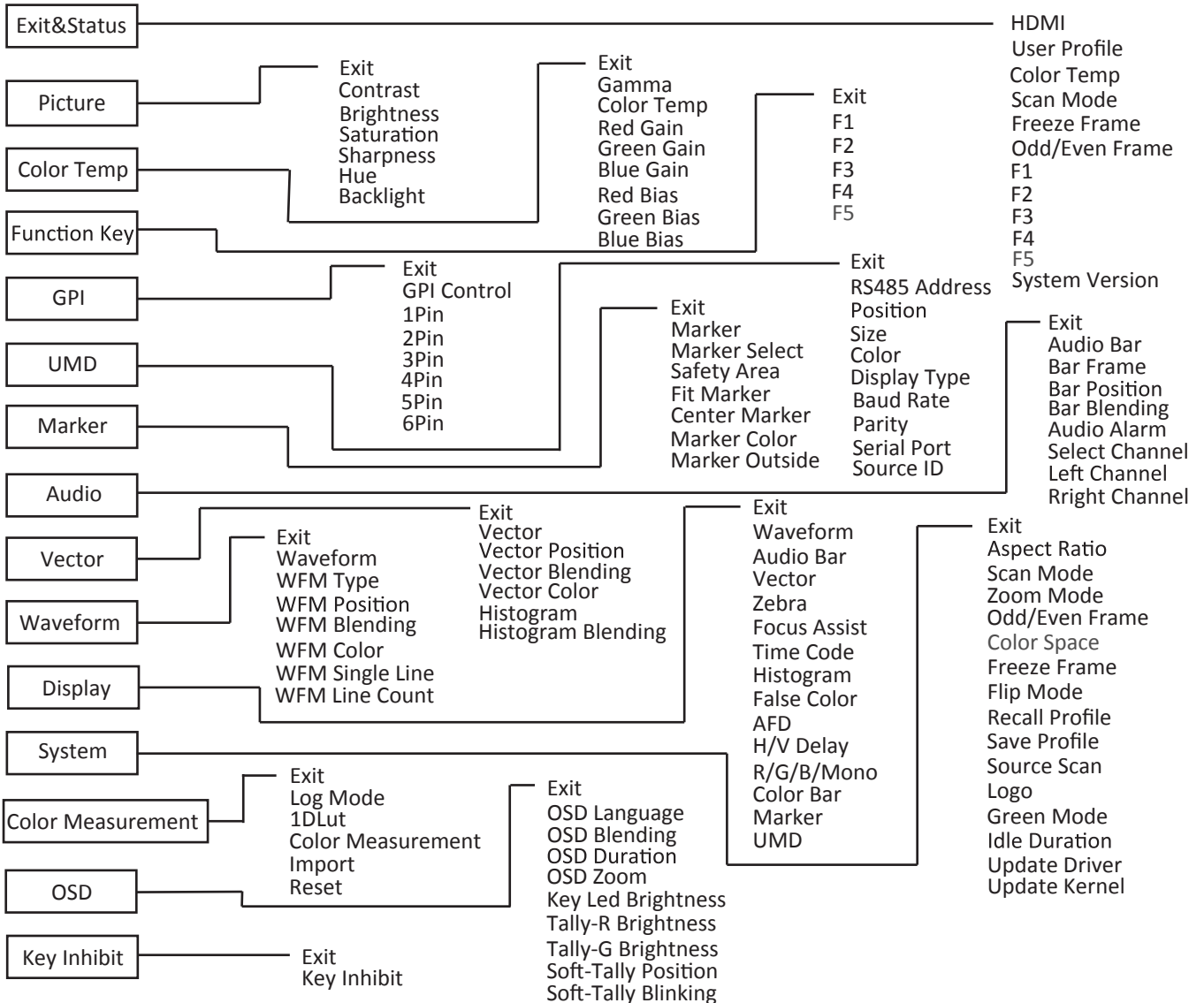

● "Exit & Status" is only displayed, and cannot be set/changed.

# Menu Configuration (cont.)

## Main Menu

### Picture Function

Setting for the picture quality.

Item	To do	Setting value
Exit	Return Main Menu	
Contrast	Adjusts the contrast of the display.	0 to 100
Brightness	Adjusts the brightness of the display.	0 to 100
Saturation	Adjusts the saturation of the display.	0 to 100
Sharpness	Adjusts the sharpness of the display.	0 to 100
Hue	Adjusts the hue of the display.	0 to 100
Backlight	Adjusts the backlight of the display.	0 to 100

### Color Temperature

Adjusts the R/G/B Gain and Bias, and Gamma Preset

Item	To do	Setting value
Exit	Return Main Menu	
Gamma	Select the Gamma correction value.	2.2 (equivalent to Y 2.2) 2.4 (equivalent to Y 2.4) 2.6 (equivalent to Y 2.6)
Color Temp	Select the color temperature Mode.	5600K、 6500K、 9300K、 User
Red Gain	Adjusts the Red Gain	0 to 255
Green Gain	Adjusts the Green Gain	0 to 255
Blue Gain	Adjusts the Blue Gain	0 to 255
Red Bias	Adjusts the Red Bias	0 to 255
Green Bias	Adjusts the Green Bias	0 to 255
Blue Bias	Adjusts the Blue Bias	0 to 255

- Only "Color Temp" is set to "User", the Red/Blue/Green Gain or Red/Blue/Green Bias can be adjusted

### Function Key

Set short-cut functions for F1-F4

Item	To do	Setting value
Exit	Return Main Menu	
F1	Assign functions to the function keys F1 - F4 on the front key board	Audio Bar, Histogram, False Color, AFD, H/V Delay, R/G/B/Mono, Marker, Color Bar, UMD, Audio Alarm, Odd/Even Frame, Focus Assist, Aspect Ratio, Scan Mode, Zoom Mode, Mute, Freeze Frame, Flip Mode, CVBS, YPbPr, VGA, Color Temp, Time Code, Zebra, Vector.
F2		
F3		
F4		

For example: Set F3 to "R/G/B/Mono" under "Function key" submenu. User can press F3 on the front panel to adjust the parameters of "R/G/B/Mono", and the "R/G/B/Mono" will change and follow the sequence: Blue Only → Red Only → Green Only → Mono → Off.

### GPI

Setting functions for external control

Item	To do	Setting value
Exit	Return Main Menu	
GPI Control*1	Enable GPI control	ON, OFF
1 Pin	Assign functions to the GPI terminals	Red Tally, Green Tally, Yellow Tally, Aspect Ratio, Scan Mode, Zoom Mode, Mute, Freeze Frame, Flip Mode, Color Temp, Time code, Zebra, Vector, Audio Bar, Histogram, False Color, AFD, H/V Delay, R/G/B/Mono, Marker, Color Bar, UMD, Audio Alarm, Odd/Even Frame, Focus Assist
2 Pin		
3 Pin		
4 Pin		
5 Pin		
6 Pin		

\*1 When "GPI control" is set to "On", the monitor can be operated through external GPI control unit.

Example 1: Under "GPI" submenu, set "GPI control" to "On", set "2 Pin" to "Red Tally", when the pin 2 of the external GPI control unit is connected with ground, the Tally light on the front panel will turn red. When disconnected, the tally light will turn off.

Example 2: Under "GPI" submenu, set "GPI control" to "On", set "6 Pin" to "Scan Mode", when the pin 6 of the external GPI control unit is connected with ground, the Scan mode will change and follow the sequence: "Normal" → "Overscan" → "Native".

# Menu Configuration (cont.)

## UMD

Setting UMD control parameters (TSL UMD Protocol V3.1/4.0, provided by Television System LTD.)

Item	To do	Setting value
Exit	Return Main Menu	
RS485 Address	Address setting 1 to 126: Set a particular address	1 to 126
Position	Position setting	Top、 Bottom
Size	Size setting	Normal、 Mid-Large、 Large
Color	Color setting	Red、 White、 Black、 Blue、 Green、 Yellow
Display Type	Choose Display Type	Source ID、 UMD
Baud Rate	Baud Rate setting	38400、 9600、 19200
Parity	Parity setting	Even、 None
Serial Port	Choose Serial Port	RS485、 RS232
Source ID	Setting of "Source ID"*1	

### \*1 Setting of "Source ID"

- (1) Change the input to one that you want to assign a video source name for.
- (2) Select "Source ID"
- (3) revolve the "MENU" button to select the first character.

Each time you revolve the "MENU" button, the character changes as follows.

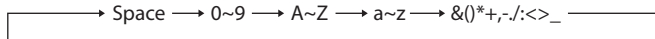

- (4) Press the "MENU" button to move the arrow to the next space.
  - The characters entered before moving the arrow are memorized.
- (5) Repeat steps (3) and (4) (8 characters at maximum).
- (6) Press MENU button to store the name.

### ● UMD setup

- (1) Connect the external control equipment with the monitor
  - (2) Set "Display Type" to "UMD"
  - (3) Set "Serial Port" to RS485 or RS232 according to the port type of external control equipment
  - (4) Make sure the "address", "Baud Rate", "Parity" the same
  - (5) Adjust the external control equipment and send UMD command, the UMD information will be display as the right photo.
- User can set the character and color of the UMD and the color of Tally1 and 2.

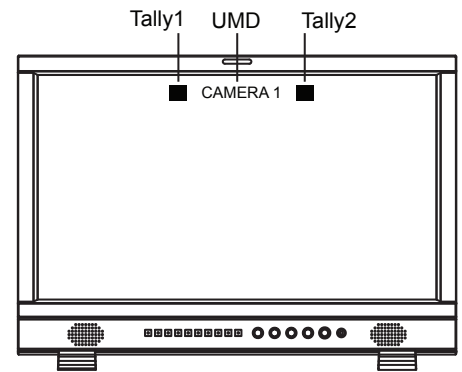

## Marker

Settings for marker functions

Item	To do	Setting value
Exit	Return Main Menu	
Marker	Display setting On: Displayed, Off: Not displayed	Off、 On
Marker Select	Adjust the ratio of marker	Off、 4:3、 13:9、 14:9、 15:9、 16:9、 1.85:1、 2.35:1
Safety Area	Safety Area setting	Off、 80%、 85%、 90%、 93%、 95%
Fit Marker*1	Fit Marker setting	Off、 On
Center Marker	Display setting On: Displayed, Off: Not displayed	Off、 On
Marker Color	Marker color setting	White、 Red、 Green、 Blue、 Black、 Gray
Marker Outside	Marker Outside color setting	Off、 Gray、 Black

\*1 When "Fit Marker" is Off, the size of safety area is benchmarked against the actual display screen, accounting for 80% ~ 95% of actual display screen. When "Fit Marker" is On, the size of safety area is benchmarked against the area inside the scales marker, accounting for 80% ~ 95% of the area inside the scales marker.

Example:

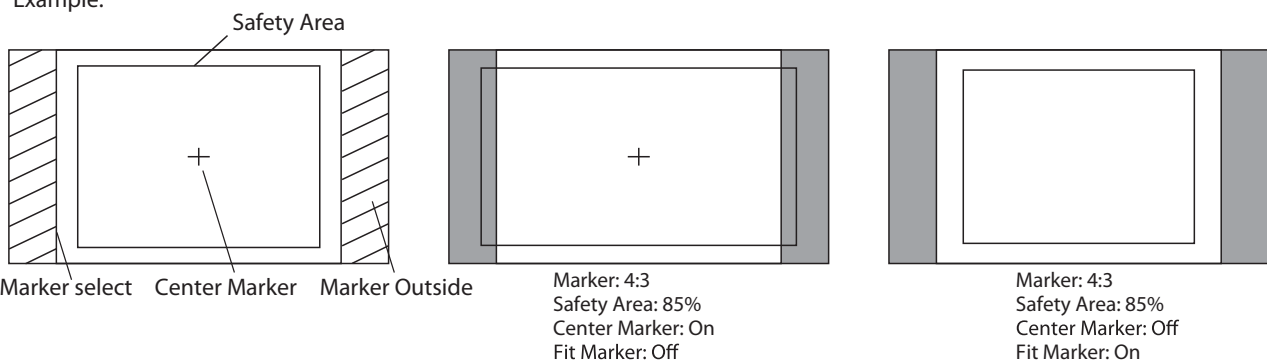

# Menu Configuration (cont.)

## Audio Setting

Setting for the audio meters and channel selection

Item	To do	Setting value
Exit	Return Main Menu	
Audio Bar	Display setting On: Displayed, Off: Not displayed	On、 Off
Bar Frame*1	Display setting On: Displayed, Off: Not displayed	On、 Off
Bar Position	Bar Position setting	Top Right、 Bottom Left、 Bottom Right、 Top Left
Bar Blending	Bar Blending setting Off: Set the background of the bar display black . Low: Set the background of the bar display gray High: Set the background of the bar display transparent.	Low、 Off、 High
Audio Alarm*2	Display setting On: Displayed, Off: Not displayed	Off、 On
Select Channel*3	Select Channel setting	HDMI : Channel 1-2、 1-8 SDI : Channel 1-2、 1-8、 1-16 ANALOG : Channel 1-2
Left Channel Right Channel*4	Select the audio left and right channels to output. The current left channel number displays green, and the right channel number displays red.	HDMI : Channel 1-8 SDI : Channel 1-16

\*1 When "Bar Frame" is set to "Off", only the audio meter will be displayed

When "Bar Frame" is set to "On", frame and real-time audio value will be displayed.

\*2 When "Audio Alarm" is set to "On", if no embedded audio is detected, the audio bar will display "UNLOCKED". If the audio value is too low, the audio bar will display "MUTE".

\*3 Select Channel

Under analog signal, only channel1-2 can be displayed.

Under HDMI signal, channel1-2 and 1-8 can be selected.

Under SDI signal, channel 1-2, 1-8 and 1-16 can be selected

\*4 Audio channels can be selected to output according to the requirements.

When the current "Select Channel" is set to "Channel1-2", the left channel and right channel output can be selected from Channel1 or channel2.

When the current "Select Channel" is set to "Channel1-8", the left channel and right channel output can be selected from Channel1 to channel8.

When the current "Select Channel" is set to "Channel1-16", the left channel and right channel output can be selected from Channel1 to channel16.

In audio bar, the left channel information will be in green, and the right channel information will be in red.

# Menu Configuration (cont.)

## Vector

Setting for Vector scope and Histogram patterns

Item	To do	Setting value
Exit	Return Main Menu	
Vector	Display setting On: Displayed, Off: Not displayed	Off、 On
Vector Position	Vector Position setting	Bottom Right、 Center、 Top Left、 Top Right、 Bottom Left
Vector Blending	Vector Blending setting Off: Set the background of the vector display black . Low: Set the background of the vector display gray High: Set the background of the vector display transparent.	Off、 Low、 High
Vector Color	Vector Color setting	Color、 White、 Green、 False Color
Histogram	Display setting On: Displayed, Off: Not displayed	Off、 On
Histogram Blending	Histogram Blending setting Off: Set the background of the histogram display black . Low: Set the background of the histogram display gray High: Set the background of the histogram display transparent.	Off、 Low、 High

## Waveform

Setting for Waveform patterns

Item	To do	Setting value
Exit	Return Main Menu	
Waveform	Display setting On: Displayed, Off: Not displayed	Off、 On
WFM Type	Waveform type setting	Y、 Cb、 Cr、 R、 G、 B
WFM Position	Waveform position setting Waveform blending setting	Bottom Left、 Bottom Right、 Center、 Top Left、 Top Right
WFM Blending	Off: Set the background of the waveform display black . Low: Set the background of the waveform display gray High: Set the background of the waveform display transparent.	Low、 High、 Off
WFM Color	Waveform color setting	White、 Green、 False Color
WFM Single Line	Display setting On: Displayed, Off: Not displayed	Off、 On
WFM Line Count	WFM Line Count setting	0 to 1079

\*1: Only the "WFM Single Line" is set to "ON", the "WFM Line Count" can be adjusted.

"WFM Single Line" is to display the selected line waveform of "WFM Line Count"

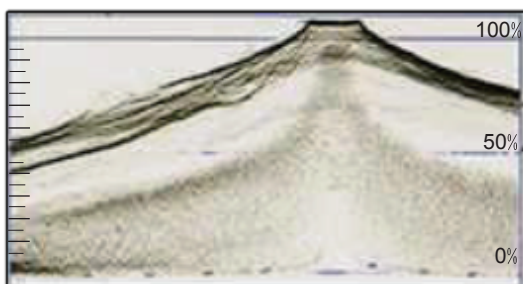

WFM Single Line: Off

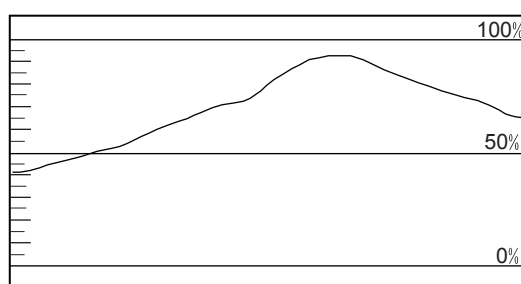

WFM Single Line: On

# Menu Configuration (cont.)

## Display

On/off control center for all function patterns display

Item	To do	Setting value
Exit	Return Main Menu	
Waveform	Display setting On: Displayed, Off: Not displayed	Off、 On
Audio Bar	Display setting On: Displayed, Off: Not displayed	Off、 On
Vector	Display setting On: Displayed, Off: Not displayed	Off、 On
Zebra	Display setting On: Displayed, Off: Not displayed	Off、 On
Focus Assist	Focus Assist setting	Off、 Blue、 Red
Time Code	Display setting On: Displayed, Off: Not displayed	Off、 On
Histogram	Display setting On: Displayed, Off: Not displayed	Off、 On
False Color	Display setting On: Displayed, Off: Not displayed	Off、 On
AFD	Display setting On: Displayed, Off: Not displayed	Off、 On
H/V Delay	Display setting On: Displayed, Off: Not displayed	Off、 On
R/G/B/Mono	R/G/B/Mono setting	Off、 Blue Only、 Red Only、 Green Only、 Mono
Color Bar	Display setting On: Displayed, Off: Not displayed	Off、 On
Marker	Display setting On: Displayed, Off: Not displayed	Off、 On
UMD	Display setting On: Displayed, Off: Not displayed	Off、 On

## System

General system mode settings and firmware upgrade

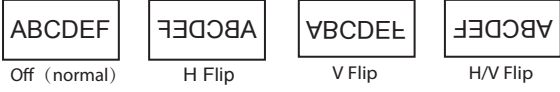
Item	To do	Setting value
Exit	Return Main Menu	
Aspect Ratio	Aspect Ratio setting	16:9、 4:3
Scan Mode	Scan Mode setting	Normal、 OverScan、 Native
Zoom Mode	Zoom Mode setting	Off、 Zoom1、 Zoom2
Odd/Even Frame	Odd/Even Mode setting	Off、 Odd Mode、 Even Mode
Freeze Frame	Display setting On: Displayed, Off: Not displayed	Off、 On
Flip Mode	Flip Mode setting 	Off、 H Flip、 V Flip、 H/V Flip
Recall Profile	Loading Factory settings and User presets Default: Recover all settings to factory setting User 1/2/3: Load the User settings 1/2/3	Factory、 User1、 User2、 User3
Save Profile	Save current User settings User 1/2/3: Save the current settings to User 1/2/3	User1、 User2、 User3
Source Scan*1	Settings for auto-scan input signals when switch on the monitor On: Automatically scan Off: Stays the signal source when the monitor is switched off	On、 Off
Logo*2	Settings to display Switch on logo or not On: Display, Off: Not display	On、 Off
Green Mode*3	Display settings when in Energy Save mode	Black Backlight、 Standby、 Gray Backlight
Idle Duration	Set an idle time to enter Energy Save mode	Off、 30Sec、 2Hours、 4Hours
Update Driver*4	Enter to upgrade Driver (USB firmware upgrade)	No、 Yes
Update Kernel*5	Enter to upgrade Kernel (USB firmware upgrade)	No、 Yes

\*1 Source Scan

When set to "Yes", next time switch on the monitor, the monitor will automatically scan the available signal source with the sequence of "SDI1→SDI2→HDMI→YPbPr→VGA→CVBS".

\*2 Logo

When powered on, the screen will display ProHD logo.

\*3 Green Mode

When no recognized signal is detected and operation time reaches the time selected in "Idle Duration", the monitor will turn to green energy saving mode: "Green mode".

Under standby, Gray Backlight, Blacklight mode, press any button on the front panel, the monitor will be back to normal status.

# Menu Configuration (cont.)

## \*4, \*5 Update Driver/ Kernel

### Operation steps:

1. Download latest firmware files to USB disk, switch on the monitor, and insert to the USB port on rear panel of the monitor
2. Press "MENU/ENTER", enter "Main Menu" - "System", and select "Update Driver" or "Update Kernel".
3. Set "Yes", the monitor will upgrade automatically.

Main Menu	System
Exit&Status >	Exit
Picture >	Aspect Ratio XX
Color Temp >	Scan Mode XXXX
Function Key >	Zoom Mode XXX
GPI >	Odd/Even Frame XXX
UMD >	Color Space XXX
Marker >	Freeze Frame XXX
Audio >	Flip Mode XXX
Vector >	Recall Profile XXX
Waveform >	Save Profile XXX
Display >	Source Scan XXX
System >	Logo XXX
OSD >	Green Mode XXX
Key Inhibit >	Idle Duration XXX
	Update Driver Yes
	Update Kernel XXX

4. During firmware upgrade, the screen will display progress percentage. Please do not cut off power during the upgrade.

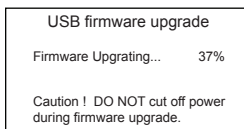

5. When succeed, the monitor will automatically re-start, and then the upgrade will be finished.

## Color Measurement

3DLUT calibration by cube import and camera logs to Rec.709 Conversion

Item	To do	Setting value
Exit	Return Main Menu	
Log Mode*1	Select a camera log LUT to convert to Rec.709	Off、J-Log1、Log-c、S-Log2、S-Log3、C-Log、V-Log、RedLogFilm、User-Log
1DLut	Select 1DLUT color files	Default、User1、User2
Color Measurement*2	Enable color measurement	Off、On
Import	Import 3DLUT calibration cube*3, camera log cube, user LUT cube or 1DLUT color file*4	3DLut.cube、J-Log1.cube、Log-C.cube、S-Log2.cube、S-Log3.cube、C-Log.cube、V-Log.cube、RedLogFilm.cube、User-Log.cube、1DLutUser1.csv、1DLutUser2.csv
Reset*5	Reset to factory imported 3DLUT cubes	3DLut.cube、J-Log1.cube、Log-C.cube、S-Log2.cube、S-Log3.cube、C-Log.cube、V-Log.cube、RedLogFilm.cube、User-Log.cube

### \*1 Camera Log conversion

When shooting with Log mode of the camera, you can select the corresponding Log conversion LUT, to convert the log mode video to standard ITU Rec.709 mode to monitor. A "User-Log" is provided for user defined LUT converting to Rec.709.

### \*2 Color Measurement enable

Before re-calibrate the monitor and start to measure the monitor display colors, please turn the "Color Measurement" on. And please turn the "Color Measurement" off when measurement finished and return to normal monitoring. It will turn off automatically when new cubes are imported or monitor restarted.

### \*3 Import re-calibrated cube or user log cubes

- (1) Calibrate the monitor by color meters and 3DLUT calibrating software, select 17x17x17, 6500K, Gamma 2.4 to calibrate, and get a correct cube file. (Konica Minolta CA-310 color meter and Spectral CalMAN software are recommended for accurate calibration)
- (2) Rename the re-calibrated cube as "3DLut.cube" (attention to the cap letters), and copy into USB stick root directory.
- (3) Insert the USB stick onto monitor USB port on the rear panel, select "Import" - "3DLut.cube" - "YES" to import the new cube.

### \*4 Import User logs and 1DLut color file

You can change all the default camera log LUTs, User logs, and 1DLut colors by USB importing new cube file at the same file name.

### \*5 Reset to factory cubes

For any wrong cubes imported that caused wrong display colors, you can reset the cubes to factory cubes here.



## OSD

Adjust the OSD display size, color, duration, and TALLY light/keyboard light settings

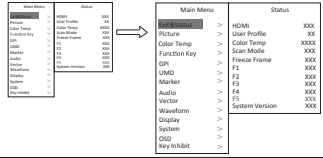
Item	To do	Setting value
Exit	Return Main Menu	
OSD Language	OSD Language setting	English、 Chinese
OSD Blending	OSD Blending setting	Low、 Medium、 High、 Off
OSD Duration*1	OSD Duration setting	10Sec、 15Sec、 30Sec、 60Sec
OSD Zoom	OSD Zoom setting 	Off、 On
Key Led Brightness	Key Led Brightness setting	Low、 Medium、 High、 Off
Tally-R Brightness	Set the brightness of tally when is red	High、 Low、 Medium
Tally-G Brightness	Set the brightness of tally when is green	High、 Low、 Medium
Soft-Tally Position	Set the position of soft-tally	Top、 Bottom
Soft-Tally Blinking	Set the blinking of soft-tally	On、 Off

\*1 During this period of time, if there's no operation to the menu, the menu will automatically quit.

## Key Inhibit

To lock the keyboard for safety operation

Item	To do	Setting value
Exit	Return Main Menu	
Key Inhibit	Key Inhibit setting	Off、 On

If the "Key Inhibit" is "On", there is no response when all the buttons except " VOLUME MENU/PUSH" are pressed, the screen will be displayed as " Key Inhibit".

User can set "Key Inhibit" under "key Inhibit" submenu to "Off" to recover the functions of all buttons.

# External Control

## About the external control

This monitor has three external control terminals.

- **RS-485 terminal** (RJ-45): Controls the monitor with the RS-485 system.  
The terminal is to connect with TallyMan system of UMD application.
- **RS-232C terminal** (D-sub 9-pin): Controls the monitor with the RS-232C system (TallyMan)  
The terminal is to connect with TallyMan system of UMD application.
- **Make contact terminal** (RJ-45):  
Controls the monitor by short-circuiting the corresponding pin terminal to the GND pin terminal, or disconnecting (opening) it.  
The terminal is to assign functions for GPI controlling.

## Using the UMD control

### <Specifications of the RS-485 terminal>

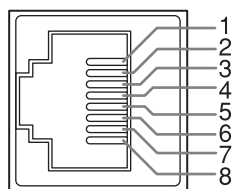

This is a female terminal.

Pin No.	IN terminal signal	OUT terminal signal
1	TXD +	TXD +
2	TXD -	TXD -
3	RXD +	RXD +
4	NC	NC
5	NC	NC
6	RXD -	RXD -
7	NC	NC
8	GND	GND

### <Serial communication>

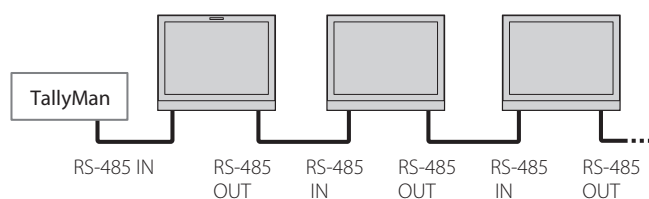

### <Specifications of the RS-232C terminal>

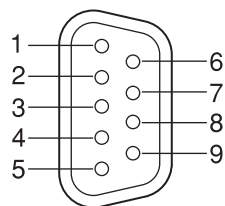

This is a female terminal.

Pin No.	Signal
1	NC
2	RXD
3	TXD
4	NC
5	GND
6	NC
7	RTS
8	CTS
9	NC

- The 7th terminal and the 8th terminal are connected.

## Using the GPI control

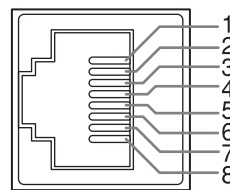

This is a female terminal.

Pin No	Pin name
1	GPI 1
2	GPI 2
3	GPI 3
4	GPI 4
5	GPI 5
6	GPI 6
7	NC
8	GND

### To assign the functions to the pin terminals

- 1 Select "GPI" on the Main Menu.
- 2 Set "GPI control" to "ON".
- 3 Select a pin name ("Pin1" - "Pin6") for which you want to assign a function, then select the function you want to assign.

### Operation of the external control

- 1 Operate each function by short-circuiting the corresponding pin terminal to the 8th pin terminal (GND) or opening it.

### <Functions controlled by the GPI terminal>

Display	Functions to be controlled	Opening	Short-circuiting
---	No function	—	—
Red Tally	Tally light red	off	Red
Green Tally	Tally light green	off	Green
Yellow Tally	Tally light yellow	off	Yellow
Aspect Ratio	Changes the aspect ratio.		*1
Scan Mode	Changes the scan mode		*2
Zoom Mode	Changes zoom mode		*3
Mute	Mute setting		*4
Freeze Frame	Freeze Frame setting		*4
Time code	Time code display		*4
Zebra	Zebra display		*4
Vector	Vector display		*4
Audio Bar	Audio Bar display		*4
Histogram	Histogram display		*4
False Color	False Color display		*4
AFD	AFD display		*4
H/V Delay	H/V Delay display		*4
Marker	Marker display		*4
Color Bar	Color Bar display		*4
UMD	UMD display		*4
Audio Alarm	Audio Alarm display		*4
Color Temp	Color Temp setting		*5
R/G/B/Mono	R/G/B/Mono setting		*6
Flip Mode	Flip Mode setting		*7
Odd/Even Frame	Odd/Even Mode setting		*8

\*1 For every short-circuiting, the Aspect Ratio value changes in the order of 16:9 → 4:3

\*2 For every short-circuiting, the Scan Mode value changes in the order of Normal → Overscan → Native

\*3 For every short-circuiting, the Zoom Mode value changes in the order of Off → Zoom1 → Zoom2

\*4 For every short-circuiting, the value changes in the order of On → Off

\*5 For every short-circuiting, the Color Temp value changes in the order of 6500K → 5600K → 9300K → User

\*6 For every short-circuiting, the R/G/B/Mono value changes in the order of Off → Blue Only → Red Only → Green Only → Mono

\*7 For every short-circuiting, the Flip Mode value changes in the order of Off → H Llip → V Flip → H/V Flip

\*8 For every short-circuiting, the Odd/Even Frame Mode value changes in the order of Off → Odd Mode → Even Mode

# Troubleshooting

Solutions to common problems related to the monitor are described here. If none of the solutions presented here solve the problem, unplug the monitor and consult an authorized dealer or service center.

Symptom	Probable cause and corrective action	Page
No power supply.	● press "POWER" button	8
	● Firmly insert the AC power plug.	7
No picture with the power on.	● Select the correct input using the INPUT SELECT buttons.	8
	● Connect the connecting cable firmly.	7
	● Turn on the power of the connected component and set the output correctly.	—
	● Check whether the input signal format is acceptable on the monitor.	22
No sound.	● Adjust the volume level.	9
	● Deactivate the muting function.	11
	● Connect the connecting cable firmly.	7
	● Turn on the power of the connected component and set the output correctly.	—
No Sync	● Select the correct input using the INPUT SELECT buttons.	8
	● Connect the connecting cable firmly.	7
	● Turn on the power of the connected component and output video signals. Or, check whether the video output of the component (video output setting of the VCR or graphic board of the computer) is set correctly.	—
Wrong color, no color.	● Adjust each picture adjustment knob on the front panel or adjust the items of "Picture" in the Main Menu.	8, 11
	● Adjust the "Recall profile" to "Default" under "System" submenu	15
	● Turn the Blue only/ Red Only/ Green Only/Mono off under R/G/B/Mono submenu	15, 18
	● Turn off the "Focus Assist" function	15, 18
	● Turn off the "False Color" function	15, 18
The picture becomes blurred.	● Adjust the picture contrast or brightness by using the adjustment knobs on the front panel. Or, adjust "Contrast" or "Brightness" of "Picture" in the Main Menu.	8, 11
Buttons on the monitor do not work.	● Set "Key Inhibit" in the Main Menu to "Off"	17

## ● The following are not malfunctions.

- When a still image is displayed for a long time, it may remain indistinctly on the screen after the picture has changed. Though the remaining picture will disappear after a while, there may be a case that it remains for a long period depending on the length of time the still image was displayed for. This is due to the characteristics of the LCD display and is not a malfunction.
- Red spots, blue spots and green spots on the panel surface are a normal characteristic of LCD panels, and not a problem. The LCD panel is built with very high precision technology; however, be aware that a few pixels may be missing or constantly lit.
- The following symptoms are problems only when pictures or sounds are not played back normally.
  - A slight electric shock occurs when you touch the LCD panel.
  - The top and/or rear panel of the monitor becomes hot.
  - The monitor emits a cracking noise.
  - The monitor emits a mechanical noise.

# Specifications

## General

Model name	DT-N21F	
Type	Multi format LCD monitor	
Screen size	Type 21.5 wide format	
Aspect ratio	16:9	
Horizontal/vertical frequency (computer signal)	H: 61.93kHz – 92.9 kHz V: 50 Hz – 75 Hz * Some signals within this frequency range may not be displayed	
Compliant video signal format	☞ "Available signals" on page 22	
Format	3G SDI: SMPTE-425M-A/B HD SDI: BTA S-004C, SMPTE292M, SMPTE-425M-A/B, SMPTE-274M, SMPTE-RP211, SMPTE-296M SD SDI: SMPTE-125M, ITU-R BT.656 2K: SMPTE ST 2048-1: 2011 EMBEDDED AUDIO: SMPTE299M, SMPTE272M	
Audio output	Internal speaker: 2.5W+2.5W(8Ω)	
Operating conditions	Operating temperature: 0°C – 40°C (41°F – 95°F) Operating humidity: 20% – 80% (non-condensing) (Slightly variable depending on ambient conditions for installation.)	
Power requirements	AC 120 V / AC 220 – 240 V, 50 Hz/60 Hz; DC11 ~ 17V	
Rated current	1.5A (AC 100V ~ 240V) 3.0A (DC11 ~ 17V)	
External dimensions (excluding protruding parts)	with the stand	without the stand
	Width: 525.3 mm (20 11/16")	525.3mm (20 11/16")
	Height: 376.3 mm (14 13/16")	358.3 mm (14 1/8")
	Depth: 135 mm (5 1/4")	86 mm (3 1/4")
Weight	6.2 kg(13.7 lbs) (with the stand)	
Accessories	AC power cord x 1	

## LCD panel

Type	21.5" wide, active matrix TFT
Effective screen size	Width: 476.64 mm (18 3/4") Height: 268.11 mm (10 9/16") Diagonal: 546.1 mm (21 1/2")
Number of pixels displayed	1920 x 1080
Number of colors displayed	16.70 million
Viewing angle (TYP.)	178° (Horizontally), 178° (Vertically)
Brightness (TYP.)	250 cd/m <sup>2</sup>
Contrast ratio (TYP.)	1000:1

## Input/output terminals

Video	CVBS	Input/output of composite signal: 1 line, BNC connector x 2, 1 V (p-p), 75 Ω * The input (IN) and output (OUT) terminals
	HDMI	HDMI connector x 2(IN and OUT)
	VGA	1 Line, mini D-SUB 15pin x1 (IN)
	YPbPr	Y: 1 V(p-p), 75 Ω(with sync) Pb : 0.7 V (p-p), 75 Ω Pr: 0.7 V (p-p), 75 Ω
	E. AUDIO 3G/ HD/SD SDI	Digital signal input (compatible with EMBEDDED AUDIO signals): auto detection, 2 line, BNC connector x 2
	E. AUDIO 3G/ HD/SD SDI	Digital signal output (compatible with EMBEDDED AUDIO signals): auto detection, 2 line, BNC connector x 2
Audio	AUDIO (IN)	Analog audio signal input: 1 line, RCA connector x 2, 500 mV (rms), high impedance
	AUDIO (MONITOR OUT)	Speaker: 2.5W+2.5W(8Ω) 3.5mm phone
External control	GPI (MAKE)	☞ "Using the GPI control" on page 18.
	UMD (RS-485)	☞ "Using the UMD control" on page 18.
	UMD (RS-232C)	

# Dimensions Unit: mm (inch)

DT-N21F

<Front view>

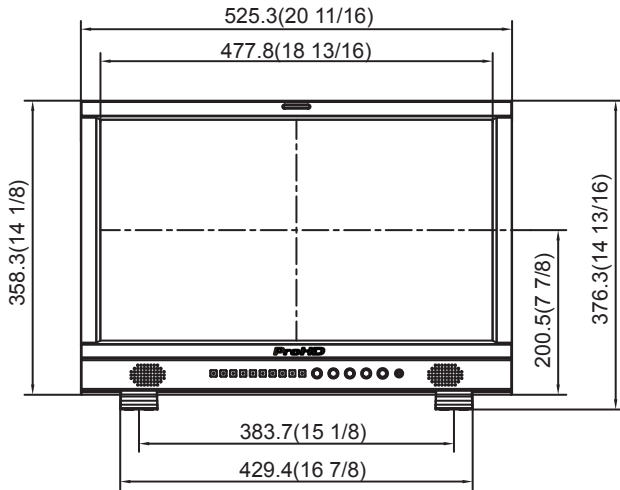

<Side view>

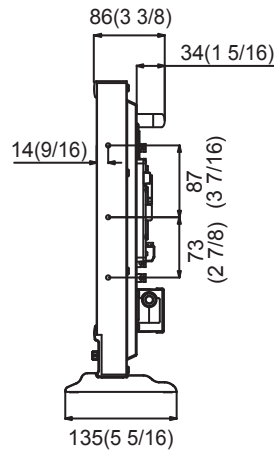

<Rear view>

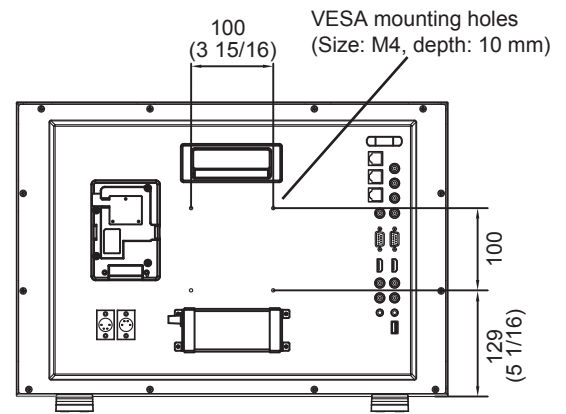

# Specifications (cont.)

## Available signals

The following signals are available for this monitor.

### Video signals

No.	Signal name	Signal format shown in the status display	Input terminal				
			CVBS	YPbPr	VGA	SDI	HDMI
1	NTSC	NTSC	√	—	—	—	—
2	NTSC 4.43	NTSC	√	—	—	—	—
3	PAL-M	PAL	√	—	—	—	—
4	PAL	PAL	√	—	—	—	—
5	PAL-N	PAL	—	—	—	—	—
6	SECAM	SECAM	√	—	—	—	—
7	480/60i	480i59.94	—	√	—	√	√
8	480/59.94i	480i59.94	—	√	—	√	√
9	576/50i	576i50	—	√	—	√	√
10	480/60p	480p59.94	—	√	—	—	√
11	480/59.94p	480p59.94	—	√	—	—	√
12	576/50p	576p50	—	√	—	—	√
13	640*480/60p	640*480	—	√	√	—	√
14	640*480/59.94p	640*480	—	√	√	—	√
15	720/60p	720p60	—	√	—	√	√
16	720/59.94p	720p59.94	—	√	—	√	√
17	720/50p	720p50	—	√	—	√	√
18	1080/60i	1080i60	—	√	—	√	√
19	1080/59.94i	1080i59.94	—	√	—	√	√
20	1080/50i	1080i50	—	√	—	√	√
21	1080/60p	1080p60	—	√	√	√	√
22	1080/59.94p	1080p59.94	—	√	√	√	√
23	1080/50p	1080p50	—	√	√	√	√
24	1080/30p	1080p30	—	√	—	√	√
25	1080/29.97p	1080p30	—	√	—	√	√
26	1080/25p	1080p25	—	√	—	√	√
27	1080/24p	1080p24	—	√	—	√	√
28	1080/23.98p	1080p24	—	√	—	√	√
29	1080/30PsF	1080PsF30	—	—	—	√	√
30	1080/29.97PsF	1080PsF30	—	—	—	√	√
31	1080/25PsF	1080PsF25	—	—	—	√	√
32	1080/24PsF	1080PsF24	—	—	—	√	√
33	1080/23.98PsF	1080PsF24	—	—	—	√	√
34	2048*1080/23.98p	1080p24	—	—	—	√	—
35	2048*1080/24p	1080p24	—	—	—	√	—
36	2048*1080/25p	1080p25	—	—	—	√	—
37	2048*1080/29.97p	1080p30	—	—	—	√	—
38	2048*1080/30p	1080p30	—	—	—	√	—
39	2048*1080/50p	1080p50	—	—	—	√	—
40	2048*1080/59.94p	1080p59.94	—	—	—	√	—
41	2048*1080/60p	1080p60	—	—	—	√	—
42	2048*1080/50i	1080i50	—	—	—	√	—
43	2048*1080/59.94i	1080i59.94	—	—	—	√	—
44	2048*1080/60i	1080i60	—	—	—	√	—

√: Acceptable

—: Not acceptable

For signal formats other than E.Audio 3G/HD/SD SDI input, \*\*/59.94, \*\*/29.97, and \*\*/23.98 will be displayed as \*\*/60, \*\*/30, and \*\*/24 respectively.

# Specifications (cont.)

## Computer signals (preset)

Analog RGB input (COMP./RGB terminals) and DVI input (HDMI terminal):

No.	Signal name	Resolution		Frequency		Scan system
		Horizontal	Vertical	Horizontal (kHz)	Vertical (Hz)	
1	VGA60	640	480	31.5	59.9	Non-interlace
2	SVGA60	800	600	37.9	60.3	Non
3	XGA60	1024	768	48.4	60.0	Non
4	WXGA(1280)	1280	768	47.8	60.0	Non
5	WXGA+60*1	1440	900	55.9	60.0	Non
6	SXGA60*1	1600	1200	75.0	60.0	Non
7	1080/60p*1	1920	1080	67.5	60.0	Non
8	WXGA(1360)	1360	768	47.7	60.0	Non

\*1 No. 5, 6, 7, signals come in, thin lines will become obscured because their signal resolution is higher than the screen resolution.

- Non-preset signals may not be displayed normally even if the frequency is within the acceptable range.

### Specification of the HDMI terminal

Connect it to the HDMI output terminal of a video device.

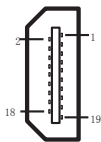

Pin No.	Input signal	Pin No.	Input signal	Pin No.	Input signal
1	T.M.D.S Data 2+	8	T.M.D.S Data 0 shield	15	SCL
2	T.M.D.S Data 2 shield	9	T.M.D.S Data 0-	16	SDA
3	T.M.D.S Data 2-	10	T.M.D.S Clock+	17	DDC/CEC GND
4	T.M.D.S Data 1+	11	T.M.D.S Clock shield	18	+5 V Power
5	T.M.D.S Data 1 shield	12	T.M.D.S Clock-	19	Hot Plug Detect
6	T.M.D.S Data 1-	13	Spare (not connected)		
7	T.M.D.S Data 0+	14	Spare (not connected)		

### Specification of the mini D-SUB15pin terminal

Connect it to the mini D-SUB15pin output terminal of a video device.

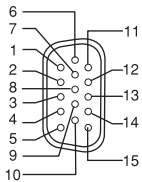

Pin No.	Input signal	Pin No.	Input signal	Pin No.	Input signal
1	Red video signal	7	Green video signal return	13	Horizontal synchronization signal
2	Green video signal	8	Blue video signal return	14	Vertical synchronization signal
3	Blue video signal	9	Not connected	15	I2C clock
4	Not connected	10	Ground		
5	Ground	11	Not connected		
6	Red video signal return	12	I2C data		

### Notice on transportation

This monitor is precision equipment and needs dedicated packing material for transportation. Never use any packing material supplied from sources other than JVC or JVC-authorized dealers.

- For easy understanding, pictures and illustrations are shown by being emphasized, omitted or composed, and may be slightly different from actual products.
- Design and specifications are subject to change without notice.
- All company names and product names mentioned herein are used for identification purposes only, and may be the trademarks or registered trademarks of their respective companies.





This model is manufactured by SWIT Electronics Co., Ltd.  
and distributed, warranted and supported in Europe by JVCKENWOOD Deutschland GmbH

To obtain service or for further information, please contact:  
JVCKENWOOD Deutschland GmbH · Konrad-Adenauer-Allee 1-11 · 61118 Bad Vilbel  
Telefon: +49 (0) 6101 / 4988 - 0 · Telefax: +49 (0) 6101 / 4988 - 50  
[www.jvcpro.eu](http://www.jvcpro.eu)

**ProHD**

SWIT Electronics Co., Ltd.  
10 Hengtong Road, Nanjing Economic and Technological Development Zone  
Nanjing 210038, P.R.China  
Tel: +86-25-85805753 Fax: +86-25-85805296 Email: [contact@swit.cc](mailto:contact@swit.cc)  
[www.swit.cc](http://www.swit.cc)