

# TRIPLETT

## Model 9055

**6-in-1 EnviroMeter with Sound  
Light, Temperature and Humidity**

*Instruction Manual*



**TRIPLETT**  
Test Equipment & Tools

84-896  
10/10



## TABLE OF CONTENTS

### TITLE

1.	INTRODUCTION.....	2
2.	SAFETY INFORMATION .....	4
3.	FEATURES.....	18
4.	SPECIFICATIONS.....	19
5.	CONTROL LOCATIONS AND DESCRIPTIONS....	26
6.	OPERATING INSTRUCTIONS .....	29
7.	MAINTENANCE .....	36
8.	WARRANTY .....	38

## **1. INTRODUCTION**

The Triplet 9055 6-in-1 Digital Multi-Tester is an autoranging ruggedized 3-3/4 digit (4000 count) precision Digital Multimeter with a large backlit high contrast LCD display and expanded measurement capabilities. In addition to the measurements performed by conventional multimeters, the 9055 also measures Sound Level, Light Level, Humidity, and Temperature. A built-in Non-Contact Voltage Sensor detects and indicates the presence of dangerous AC voltages.

The 9055's offering of conventional multimeter measurement features includes AC and DC Voltage and Current, Resistance, Continuity, Diode Test, Capacitance, Frequency, and Duty Cycle.

The overmolded housing provides impact and drop resistance in a sleek ergonomic package, and the convenient Auto Power Off feature maximizes battery life. Its industry leading CAT IV design provides superior resistance to damage from transient overvoltages such as those experienced in demanding industrial settings.

The dBC Sound Level function is useful for measuring noise in factories, schools, hospitals, offices, airports, homes, etc..... and checking the acoustics of studios, auditoriums, churches, home theater installations, etc.

The Light Level function measures illumination in Lux on two ranges. Its silicon sensor is very stable and fully cosine corrected for the angular incidence of light.

Temperature is measureable in the meter itself or at the tip of the provided temperature probe.

Relative Humidity is measured and displayed continuously along with the room temperature, providing a convenient reference for all other measurements.

The 9055 is well suited for use in all test environments, from occasional use in residential applications, to everyday use by installers, home theater technicians, security technicians, electricians, HVAC technicians, and other professionals in the electrical and electronics industry.

## 2. SAFETY INSTRUCTIONS

This meter has been designed with safety in mind, but like all products of this type, must be operated carefully to obtain the best performance and avoid injury.

**NEVER** apply voltage or current to the meter that exceeds the following specified limits:

Input Protection Limits	
Function	Maximum Input
Volts AC / DC	600V AC / DC rms CAT IV 1000V DC CAT III 700V AC CAT III
mA AC / DC	400mA / 660V AC / DC rms
A AC / DC	10A / 600V for 30 seconds max every 15 minutes
Frequency, Resistance, Capacitance, Duty Cycle, Diode Test, Continuity, Temperature	600V AC / DC rms



This symbol on the product means to refer to this manual for safety cautions or warnings.



This symbol on the product means that dangerous voltages may be present. Use caution.



- 2.1 Read all instructions in this manual before using this meter. Failure to do so may result in damage to the meter or injury to the user.
- 2.2 Prior to using the meter in any situation which could result in injury to the user, in order to verify that the meter is functional and producing a valid reading, test the meter on a circuit(s) known to have potentials equivalent to the potential that is to be measured. For example, before using the meter to determine if an AC power line is energized with 120VAC, test the meter on a line known to be energized with 120VAC. Failure to do so may result in damage to the meter or injury to the user.
- 2.3 Do not use this meter with its case open, or with parts removed. Doing so may damage the meter and/or injure the user.
- 2.4 When using this meter in schools and workshops, responsible teachers or skilled personnel must control the usage of this meter. Failure to observe this precaution may result in damage to the meter or injury to the user.

- 2.5 Follow the recommendations of any Trade Organizations or Regulatory Agencies whose scope encompasses the use of this meter. Failure to do so may result in damage to the meter or injury to the user.
- 2.6 Do not open this meter for maintenance without first disconnecting the test leads from all external circuitry. Failure to observe this precaution may result in damage to the meter or injury to the user.
- 2.7 Repairs and maintenance must only be carried out by qualified service personnel or qualified electricians / technicians who know the dangers of, and the safety rules applicable to this type of equipment. Failure to observe this precaution may result in damage to the meter or injury to the user.
- 2.8 Always set the meter to the appropriate range or mode before connecting it to the circuitry to be tested. Failure to observe this precaution may result in damage to the meter or injury to the user.



- 2.9 Check the condition of the test leads before making a measurement. Do not use the test leads if there is damaged insulation or exposed metal. Failure to observe this precaution may result in damage to the meter or injury to the user.
- 2.10 Make sure test leads are properly inserted and seated in the meter's input jacks. A loose test lead may cause the user to believe that no hazard exists, when in fact, dangerous voltages or currents may be present. Failure to observe this precaution may result in damage to the meter or injury to the user.
- 2.11 Do not touch the tips of the test leads when making a measurement. Do not touch live circuitry when making a measurement. Failure to observe this precaution may result in damage to the meter or injury to the user.
- 2.12 Before using the meter, examine both the meter and the test leads for damage. Do not use the meter if damage (damaged insulation, exposed metal, cracked case, burnt smell, etc.) is evident.

Failure to observe this precaution may result in damage to the meter or injury to the user.

- 2.13 Insert the test leads in the jacks specified in the instructions for performing particular tests. Inserting the test leads in incorrect jacks can damage the meter and/or injure the user.
- 2.14 Do not exceed the maximum voltage or current limitations of the meter. Doing so may damage the meter and/or injure the user.
- 2.15 Do not apply voltage or current to the input of the meter when it is set to any of the Ohms  $\square$  ranges. Doing so may damage the meter and/or injure the user.
- 2.16 Do not apply voltage or current to the input of the meter when it is set to the Diode Test  , Continuity Beeper  , Capacitance **CAP**, or **F** or **C** modes. Doing so may damage the meter and/or injure the user.

- 2.17 Do not attempt to measure a voltage source with the test leads plugged into the meter's uAmA or 10A jacks. Doing so may damage the meter and/or injure the user.
- 2.18 Do not rotate the Function switch with the test leads connected to the circuitry to be tested. Doing so may damage the meter or the circuitry, and/or injure the user.
- 2.19 Replace fuses only with exact or equivalent fuses. Do not "bridge" fuses out of circuit. Failure to observe this precaution may result in damage to the meter or injury to the user.
- 2.20 Do not apply voltages to the input of the meter which are elevated above the earth ground potential by more than 600V CAT IV AC/DC or 1000V CAT III AC/DC. Doing so may damage the meter and/or injure the user.
- 2.21 Do not continue to use meter when the "low battery" symbol  is displayed. The displayed reading may be in error and lead the user to believe that no

hazard exists, when in fact, dangerous voltages or currents may be present. Failure to observe this precaution may result in damage to the meter or injury to the user.

- 2.22 Use caution when working with voltages above 25 volts AC or 35 volts DC. Such voltages may cause a life threatening electrical shock.
- 2.23 This meter is not for use by children. Failure to observe this precaution may result in damage to the meter or injury to the user.
- 2.24 Do not use this meter to make measurements in adverse environments such as rain, snow, fog, or locations with steam, explosive gases or dusts. Doing so may damage the meter and/or injure the user.
- 2.25 Do not use meter in condensing atmospheres. That is, do not use meter in conditions where ambient temperature and humidity could cause condensation of water inside of meter. Doing so may cause injury to the user.

- 2.26 Do not use the meter if either the meter or the test leads are wet, either from exposure to the weather, or after cleaning the case of the meter. Doing so may cause injury to the user.
- 2.27 Do not attempt immediate use of the meter when bringing it from a cold environment to a warm environment. Condensation of water, inside and outside of the meter, may produce dangerous measuring conditions. Allow the meter to warm to room temperature before using. Failure to observe this precaution may result in damage to the meter or injury to the user.
- 2.28 Do not modify the meter. Changing the design may make the meter unsafe and may result in injury to the user.
- 2.29 Use caution when attempting to evaluate if a dangerous voltage is present. The meter will not read AC voltage if it is set to DC, nor will it read DC if it is set to AC. For example, if the meter is set to VDC, it will not measure a dangerous AC voltage, even if the probes are inserted into a household AC wall outlet.

- 2.30 Do not touch the metallic portion of one test lead if the other test lead is connected to a live circuit. The current from the live circuit may pass through the meter and appear on the unconnected test lead. Failure to observe this warning may result in user injury.
- 2.31 Do not attempt to use meter when no display is present on LCD. Doing so may damage the meter and/or injure the user.
- 2.32 Use caution when measuring circuits containing capacitors. Capacitors can store dangerous or lethal levels of electricity, even when the circuitry which they are in has been disconnected from its power source. Some capacitors could source enough energy to damage the meter and/or injure the user.
- 2.33 Do not use the meter if there is evidence of chemical leakage from the battery. Leakage could damage meter and lead to injury of user.

- 2.34 Do not use this meter to measure current in circuits whose open circuit voltage exceeds 600V AC/DC. The meter's fuses are rated at 600V max. Failure to observe this precaution may result in damage to the meter or injury to the user.
- 2.35 When you use the meter to check a high-voltage circuit, do not try to connect both test leads at once. Instead, clip one probe to the neutral or ground lead of the circuit (usually a bare, green, or white wire in AC wiring circuits) using the insulated slip-on Alligator Clips. Then probe for voltages with the other test lead. This helps prevent you from accidentally touching a hot wire, since you need to concentrate on only one test lead. Failure to observe this precaution may result in damage to the meter or injury to the user.
- 2.36 If there is any doubt about the condition of the meter (i.e. safe vs unsafe), remove the meter from service and secure it in a location that will prevent its unintentional use. Failure to observe this precaution may result in damage to the meter or injury to the user.

- 2.37 Do not use the meter if it does not appear to work correctly on all ranges and in all modes. Failure to observe this precaution may result in damage to the meter or injury to the user.
- 2.38 Do not use the meter if it has undergone long-term storage under unfavorable conditions. Failure to observe this precaution may result in damage to the meter or injury to the user.
- 2.39 Do not use the meter if it may have been damaged in transport. Failure to observe this precaution may result in damage to the meter or injury to the user.
- 2.40 Always connect one of the meter's alligator clips to the low side of a power circuit first. Never clamp onto a hot wire first, (usually red, black, or blue in AC wiring circuits.) If you clamp onto a hot wire first, and touch the other probe, you could receive a shock. Failure to observe this precaution may result in damage to the meter or injury to the user.



- 2.41 To avoid damage to the meter and possible user injury, disconnect test leads from test points before changing the function/range. Failure to observe this precaution may result in damage to the meter or injury to the user.
- 2.42 Avoid usage near strong magnetic fields (magnets, loudspeakers, transformers, motors, coils, relays, contactors, electromagnets, etc.). The meter may display readings that are in error, causing the user to misinterpret the hazards present. For example, the meter may indicate a low voltage when high voltages are actually present. Failure to observe this precaution may result in damage to the meter or injury to the user.
- 2.43 Avoid usage near strong electrostatic fields (high voltage power lines, televisions, computer monitors, etc.). The meter may display readings that are in error, causing the user to misinterpret the hazards present. For example, the meter may indicate a low voltage when high voltages are actually present. Failure to observe this precaution may result in damage to the meter or injury to the user.

- 2.44 Avoid usage near strong RF fields (radio or television transmitters, walkie talkies, cellular phones, etc.). The meter may display readings that are in error, causing the user to misinterpret the hazards present. For example, the meter may indicate a low voltage when high voltages are actually present. Failure to observe this precaution may result in damage to the meter or injury to the user.
- 2.45 Remove the battery when the meter may be left unused for longer than 1 month. Chemical leakage from the battery could damage the meter, leading to user injury.
- 2.46 Do not attempt to test charged capacitors. Only discharged capacitors may be tested. If you wish to test a capacitor, discharge it using an approved method before connecting it to the meter. **Caution:** Some capacitors can store dangerous lethal charges. Discharging these capacitors can be dangerous unless an approved method is used. Failure to observe this precaution may result in damage to the meter or injury to the user.

2.47 The Non-Contact AC Voltage Detector in the 9055 may not detect the presence of AC voltage in all situations. In particular, a twisted 3 phase cable tends to cancel out its electrostatic field, which can make the cable appear to be "dead". Use caution and good work practices at all times, even when the 9055 indicates that AC voltage is not present. Failure to observe this precaution may result in user injury.

### **3. FEATURES**

- Deluxe Autoranging DMM with Enviro Measurement
- Built-in Light Level Meter (Lux)
- Built-in Sound Level Meter (dBC)
- Built-in Ambient Temperature Meter (°F and °C)
- Built-in Humidity Meter (%RH)
- Continuous Enviro Display (Temperature and Humidity)
- Built-in Non-Contact AC Voltage Sensor
- Temperature Measurement with Included Probe (°F and °C)
- Large High Contrast Backlit LCD Display (fully annunciated)
- 3-3/4 Digit Resolution (4000 Counts)
- CAT IV 600V Performance
- Voltage Ranges: 700V AC, 1000V DC
- AC/DC Current Ranges to 10A
- Resistance Ranges from 400 Ohms to 40M Ohms
- Capacitance Ranges from 50nF to 100uF
- Frequency Ranges from 5Hz to 10MHz
- Diode Test
- Continuity Beeper
- Hold 'Freezes' Reading
- REL 'Zeros' Reading

- Auto or Manual Ranging
- Auto Power Off
- Rugged Overmolded Case Design
- Built-in Stand and Test Lead Holders
- Fused  $\mu\text{A}$ ,  $\text{mA}$ , and  $\text{A}$  Ranges
- Overload Protected
- Double Insulated
- CE Rated (EMC / LVD)
- CAT I, II, III, and IV Compliance
- 3 Year Warranty
- Includes: Safety Test Leads, Thermocouple Probe, and 9V Battery

#### 4. SPECIFICATIONS

**Display:** LCD with White Backlight, 3-3/4 digits (4000 count), Fully annunciated.

**Polarity:** Automatic, (-) negative polarity indication.

**Over Range:** "OL" displays for  Over Range.

**Low battery indication:** '  ' is displayed when the battery is low.

**Measurement rate:** 3 times per second, nominal.

**Operating environment:** : 32°F~104°F at less than 70 % relative humidity. Short term exposure to higher humidity permitted to measure Relative Humidity.

**Storage temperature:** 14 °F to 140 °F at less than 80 % relative humidity.

**Battery:** Standard 9V, NEDA1604 or 6F22 battery.

**Dimensions:** 6-5/8" x 3" x 1-7/8"

**Weight: Approx:** 11.2 oz (including battery)

The following accuracies are valid for 65 °F to 83 °F, less than 70 % RH

### Sound Level

Range	Resolution	Accuracy
35 to 100dB	0.1dB	± 5 dB at 94 dB sound level, 1kHz sine wave

Typical instrument frequency range: 30Hz-10kHz

Frequency Weighting: C –weighting

Time Weighting: Fast

Microphone: Electric condenser microphone.

### Light

Range	Resolution	Accuracy
4000 Lux	1 Lux	± 5% rdg
40,000 Lux	10 Lux	+ 10 dgts

Calibrated to standard incandescent lamp at color temperature 2856 k .

Repeatability: ± 2%

Temperature Coefficient: ± 0.1% / °C

Off Angle Light: Cosine corrected.

Photo detector: Silicon photo diode with filter mimicks spectral sensitivity characteristic of C.I.E. (International Commission on Illumination) photopia curve  $V(\lambda)$ .

Spectral Sensitivity (%) versus Wavelength (nm)

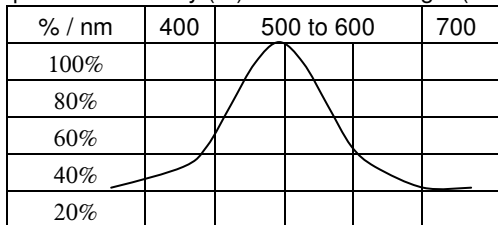

### Humidity

Range	Resolution	Accuracy
33% ~ 99% RH	1% RH	3.5% of rdg $\pm$ 5 dgts

Response Time: Allow 2 hours for accurate reading.

### Temperature

Using External Probe

Range	Resolution	Accuracy
-4°F~+1400°F	1°F	3% of rdg $\pm$ 9 dgts
-20°C~+750°C	1°C	3% of rdg $\pm$ 5 dgts

Probe: K Type Thermocouple. Limit measurement to 300°F when using probe provided with product. Use appropriate K type thermocouple for measuring higher temperatures.

### Internal Sensor in Meter (Room Temperature)

Range	Resolution	Accuracy
32°F ~+122°F	0.1°F	3% of rdg ± 2 degrees
0°C ~+50°C	0.1°C	3% of rdg ± 1 degree

### DC Voltage

Range	Resolution	Accuracy
400.0mV	0.1mV	± 1.0% of rdg ± 4 dgts
4.000V	1.0mV	
40.00V	10mV	
400.0V	100mV	± 1.5% of rdg ± 4 dgts
600V	1V	

Input Impedance: 10MΩ.

Overload Protection: 600V CAT IV AC/DC

1000V CAT III DC

700V CAT III AC

### AC Voltage

Range	Resolution	Accuracy
400.0mV	0.1mV	± 1.5% of rdg ± 15 dgts
4.000V	1.0mV	± 1.0% of rdg ± 4 dgts
40.00V	10mV	
400.0V	100mV	± 1.5% of rdg ± 4 dgts
600V	1V	± 2% of rdg ± 4 dgts

Input Impedance: 10MΩ



Frequency Range: 50 to 400Hz

Overload Protection: 600V CAT IV AC/DC

1000V CAT III DC

700V CAT III AC

### DC Current

Range	Resolution	Accuracy
400.0uA	0.1uA	± 1.0% of rdg ± 4 dgts
4000uA	1uA	
40.00mA	10uA	± 1.2% of rdg ± 4 dgts
400.0mA	100uA	
4.000A	1mA	± 2.0% of rdg ± 5 dgts
10.00A	10mA	

Overload Protection: 500mA /660V and 10A / 600V fuse

Maximum Input: 400mA AC/DC on uA / mA ranges, 10A AC/DC on 10A range (30 seconds max every 15 minutes).

### AC Current

Range	Resolution	Accuracy
400.0uA	0.1uA	± 1.2% of rdg ± 4 dgts
4000uA	1uA	
40.00mA	10uA	± 1.5% of rdg ± 4 dgts
400.0mA	100uA	
4.000A	1mA	± 2.0% of rdg ± 5 dgts
10.00A	10mA	

Overload Protection: 500mA /660V and 10A / 600V Fuse

AC Response: 50 Hz to 400 Hz

Maximum Input: 400mA AC/DC on uA / mA ranges, 10A AC/DC on 10A range (30 seconds max every 15 minutes).

### Resistance

Range	Resolution	Accuracy
400.0Ω	0.1Ω	± 1.5% of rdg ± 4 dgts
4.000kΩ	1Ω	± 1.5% of rdg ± 3 dgts
40.00kΩ	10Ω	
400.0kΩ	100Ω	
4.000MΩ	1kΩ	± 2.0% of rdg ± 3 dgts
40.00MΩ	10KΩ	± 2.5% of rdg ± 3 dgts

Maximum open circuit voltage: 2.8V.

Overload Protection: 600V AC/DC for 15 seconds

### Capacitance

Range	Resolution	Accuracy
50.00nF	10pF	± 5.0% of rdg ± 70 dgts
500.0nF	0.1nF	± 4.0% of rdg ± 5 dgts
5.000μF	1nF	
50.00μF	10nF	
100.0μF	0.1uF	

Input Protection: 600V AC/DC

## Frequency

Range	Resolution	Accuracy
5.000Hz	0.001Hz	± 1.2% of rdg ± 3 dgts
50.00Hz	0.01Hz	
500.0Hz	0.1 Hz	
5.000kHz	1 Hz	
50.00kHz	10Hz	
500.0kHz	100Hz	
5.000MHz	1kHz	± 1.5% of rdg ± 4 dgts
10.00MHz	10KHz	

Sensitivity: 0.5V RMS at frequencies less than 1MHz ; 3V  
RMS at frequencies greater than 1MHz ;  
Input Protection: 600V AC/DC

## Duty Cycle

Range	Resolution	Accuracy
5 to 95%	0.1%	+/- 5% rdg

## Diode and Continuity

Range	Test Current	Other
Diode Test	1.4mA, 2.8V Open Circuit Voltage	0 to 1.000V +/- 2% typ
Continuity		Beeps if < 50Ω

Overload Protection: maximum 600V dc or 600V ac rms.

## 5. CONTROL LOCATIONS AND DESCRIPTIONS

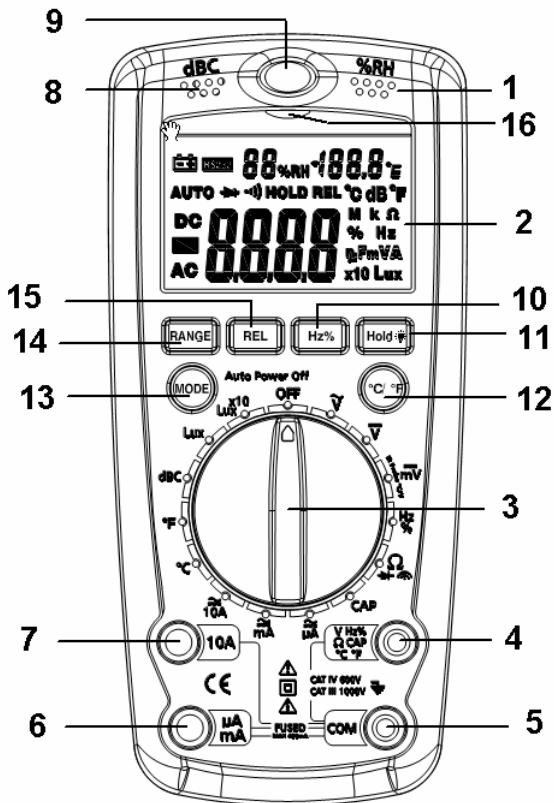

## CONTROL LOCATIONS AND DESCRIPTIONS (cont.)

1. Humidity & Temperature Sensor
2. LCD Display
3. Function Switch
4. **V/Hz%/Ω/Cap/ Temp** Input Jack
5. **COM** Input Jack
6. **uA/mA** Input Jack
7. **10A** Input Jack
8. Sound Level Sensor
9. Light Level Sensor
10. **Hz/%** Button  
Selects Hz or Duty Cycle measurement when DMM is set to Hz/% range or AC Voltage or AC Current ranges.
11. **HOLD** and Backlight Button  
Press and release quickly (less than 2 seconds) to HOLD (freeze) the reading on the LCD display. To remove HOLD, press and release quickly again. To turn on Backlight, press and hold until Backlight comes on. To turn off Backlight, press and hold until Backlight goes off. LCD shows 'HOLD' when it is on.
12. **°C / °F Room** Button  
Press to change room temperature readout from °C to °F .
13. **MODE** Button  
The button to select AC or DC measurement when in A, mA , and uA .... or select Ω,  $\rightarrow+$ ,  $\bullet$ ))) modes. The appropriate annunciator appears on the LCD to indicate the selected mode.

14. **Range** Button

Press to change from Autoranging to manual ranging. Press repeatedly to select the desired range. To return to Autoranging, press and hold the button until 'Auto' appears in the display. The LCD annunciators indicate the selected range.

15. **REL** Button

The relative measurement feature allows you to make measurements relative to a stored reference value. A reference voltage, current, capacitance, etc. can be stored and measurements made in comparison to that value. This feature is usually used to 'zero' residual readings on some ranges prior to taking measurements. REL does not work on all ranges and functions. To activate, first observe the reading to be 'REL'ed' on the LCD, then press and release the REL button. The LCD should then indicate 'zero'. Make the desired measurements. To de-activate REL, press and release the REL button again. 'REL' appears in the display when REL is active.

16. **AC Voltage LED**

This LED lights when the top of the meter is positioned close to AC voltage. In some cases the LED may not light, even tho' AC voltage is present. **DO NOT RELY ON THIS LED TO INDICATE THE PRESENCE OF AC VOLTAGE. DOING SO MAY RESULT IN INJURY TO THE USER.**

## 6. OPERATING INSTRUCTIONS

### Measuring Sound Level

1. Set the Function Switch to the “dBC” position.
2. Hold the face of the meter perpendicular to the sound source.
3. The sound level will be displayed.

Note:

Strong wind (over 20mph) striking the microphone can cause reading errors.

### Measuring Humidity

1. Place meter in the location to be measured. Allow meter to set in this location for at least 2 hours.
2. Set the Function Switch to any position other than OFF.
3. Read Humidity (%RH) from the LCD.

### Measuring Light Level

1. Set the Function Switch to “Lux” or “x10 Lux” range.
2. Hold the face of the meter perpendicular to the light source.
3. Read the light level from the LCD display.

Notes:

If the LCD reads ‘OL’ (Over Load), set the meter to “x10 Lux”. If already on the “x10 Lux” range, the light level exceeds the measurement range of the meter.

When using the “x10 Lux” range, add a zero to the end of the displayed value to obtain the correct light level.

## **Measuring Temperature (Room)**

1. Place meter in the location to be measured. Allow meter to set in this location for at least 1 hour.
2. Set the Function Switch to any position other than OFF.
3. Read Room Temperature from the LCD.

Note:

Select °C or °F readout using the “°C / °F Room “ Button.

## **Measuring Temperature (using probe)**

1. Insert the black plug of the temperature probe into the COM jack and red plug into the " V/Hz%/Ω/Cap/ Temp " jack.
2. Set the Function Switch to °C or °F as desired.
3. Touch the tip of the probe to the object to be measured.
4. Read the temperature on the LCD.

Notes:

The included probe can measure up to approximately 300 °F without damage. To measure higher temperatures, use a high temperature probe.

If the ambient temperature of the meter is changed suddenly, the meter may display erroneous readings until the meter reaches the same temperature as its surroundings.



## Measuring DC Voltage

1. Insert the black test lead into the COM jack and red test lead into the “V/Hz%/Ω/Cap/ Temp” jack.
2. Set the Function Switch to the DCV range and connect the test leads across the source or load under measurement.
3. Read the DC voltage on the LCD.
4. If the voltage to be measured is less than 400mV, set the meter to the DCmV range and then read the voltage on the LCD.

Notes:

Use the RANGE button to manually select the desired DCV range.

Use the REL button to ‘zero’ a reading.

Use the HOLD button to freeze a reading or turn on the Backlight.

## Measuring AC Voltage

1. Insert the black test lead into the COM jack and red test lead into the “V/Hz%/Ω/Cap/ Temp” jack.
2. Set the Function Switch to the ACV range and connect the test leads across the source or load under measurement.
3. Read the AC voltage on the LCD.
4. If the voltage to be measured is less than 400mV, use the RANGE button to manually select the 400mV range.

Notes:

Use the RANGE button to manually select the desired ACV range. The 400mV AC range can only be selected with the RANGE button.

Use the REL button to 'zero' a reading.

Use the Hz% button to measure the Frequency or Duty Cycle of the AC voltage.

Use the HOLD button to freeze a reading or turn on the Backlight.

### **Measuring AC or DC Current**

1. Insert the black test lead into the COM jack.
2. For current measurements up to  $4000\mu\text{A}$ , set the function switch to the ' $\mu\text{A}$ ' position and insert the red test lead banana plug into the ' $\mu\text{A}/\text{mA}$ ' jack.
3. For current measurements up to  $400\text{mA}$ , set the function switch to the ' $\text{mA}$ ' position and insert the red test lead banana plug into the ' $\mu\text{A}/\text{mA}$ ' jack..
4. For current measurements up to  $10\text{A}$ , set the function switch to the ' $10\text{A}$ ' position and insert the red test lead into the ' $10\text{A}$ ' jack.
5. Select AC or DC measurement by pressing the MODE button. The mode setting is shown by annunciators on the LCD display.
6. Remove power from the circuit under test, then open up the circuit at the point where you wish to measure current.
7. Connect the black test probe tip to the negative side of the circuit.

Connect the red test probe tip to the positive side of the circuit.

8. Apply power to the circuit.
9. Read the current on the LCD display.

Notes:

Use the RANGE button to manually select current ranges.

Use the REL button to 'zero' a reading.

Use the Hz% button to measure the Frequency or Duty Cycle of an AC current.

Use the HOLD button to freeze a reading or turn on the Backlight.

## **Measuring Capacitance**

1. Insert the black test lead into the COM jack and the red test into the "V/Hz%/Ω/Cap/Temp" jack.
2. Set the Function Switch to the CAP position.
3. If the reading on the LCD display is not zero (this is normal), press the REL button to zero the display.
4. Touch the test probe tips to the part under test.
5. Read the capacitance value on the display.

Notes:

NEVER TEST 'CHARGED' CAPACITORS. Attempting to do so may result in damage to the product or injury to the user.

The capacitance ranges cannot be manually selected.

Capacitors larger than 10uF may take several seconds to measure.

## Measuring Frequency

1. Insert the black test into the COM jack and the red test lead into the V/Hz%/Ω/Cap/°C jack.
2. Set the Function Switch to the 'Hz %' position.
3. Touch the test probe tips to the circuit under test.
4. Read the frequency on the display.

## Measuring Resistance



1. Set the Function Switch to the  $\Omega$   position.
2. Insert the black test lead into the COM jack and the red test lead into the V/Hz%/Ω/Cap/Temp jack.
3. Touch the test probe tips across the circuit or part under test.
4. Read the resistance in the display.

### Notes:

When the test leads are not connected to a component or circuit, the LCD will display 'OL'.

DO NOT CONNECT THE TEST LEADS TO ANY PART OR CIRCUIT WITH VOLTAGE PRESENT. DOING SO MAY DAMAGE THE METER OR RESULT IN USER INJURY.

## Measuring Diodes

1. Set the Function Switch to the  $\Omega$   position.
2. Insert the black test lead into the COM jack and the red test lead into the V/Hz%/Ω/Cap/Temp jack.
3. Press the MODE button repeatedly until the diode annunciator '' is visible on the LCD.

4. Touch the test probes to the diode under test. Forward voltage will typically indicate 0.400 to 0.700V. Reverse voltage will indicate “OL”. Shorted devices will indicate near 0V and an open device will indicate “OL” in both polarities.

Note:

DO NOT CONNECT THE TEST LEADS TO ANY PART OR CIRCUIT WITH VOLTAGE PRESENT. DOING SO MAY DAMAGE THE METER OR RESULT IN USER INJURY.

### **Audible Continuity Test**

1. Set the Function Switch to the  position.
2. Insert the black test lead into the COM jack and the red test lead into the V/Hz%/Ω/Cap/Temp jack.
3. Touch the test probe tips to the circuit you wish to check.
4. If the resistance is less than approximately 50Ω, the beeper will sound. If the circuit is open, the display will indicate “OL”.

### **AC Voltage Sensor**

1. Set the Function Switch to any position other than OFF.
2. Holding the meter, position its top near wires suspected as having ‘live’ AC voltage.
3. If the wires have 50 to 1000V AC (60Hz) the AC Voltage LED will light.

Note:

The AC Voltage Sensor will not work in all situations. Metal in the vicinity can block the AC signal. Phase cancellation may make it appear as if no AC is present, when in fact dangerous AC is present. Bright sunlight may make it appear as if the LED is not lit. NEVER RELY ON THE AC VOLTAGE SENSOR TO INDICATE IF DANGEROUS VOLTAGE IS PRESENT. DOING SO MAY RESULT IN USER INJURY.

It is normal for the AC Voltage Sensor LED to light when measuring AC voltages with the test leads.

## **7. MAINTENANCE**

Your Triplet Model 9055 DMM is a precision measuring instrument and, when used as described in this manual, should not require maintenance.

However, periodic calibration of the meter will insure that it is accurate and performing in accordance with its design specifications.

A one year calibration interval is suggested.

To clean the outside of the meter, use a cloth dampened with a mild detergent solution. Do not use any abrasive cleansers, or chemical solvents that may damage the case of the meter.

## Battery and Fuse Replacement

If “  “ appears on the LCD display, replace the battery. Remove 8 screws on the back cover and open the case. Replace the exhausted battery. Reassemble case.

Fuses usually blow because of operator error. If a fuse blows, examine the test setup and correct any problems before replacing the fuse(s) and retesting. Open the case by removing 8 screws. Replace the fuses only with fuses of equal rating. Using inappropriate fuses may damage the meter or result in user injury.

### **Warning:**

Never open the case of the meter with the test leads connected to the meter. Doing so may result in user injury.

### Replacement Parts:

Test Leads .....	79-808
Fuse 1: 10A / 600V fast blow, 1-1/4" x 1/4" .....	3207-132
Fuse 2: 500mA / 660V fast blow, 5 x 20mm .....	3207-136

## **Triplett Product Return Instructions**

In the unlikely event that you must return your Triplett equipment for repair, the following steps must be taken.

- 1) Call 1-800-TRIPLETT to obtain a Return Material Authorization (RMA) number from Customer Service.
- 2) Enclose a copy of the original sales receipt showing date of purchase.
- 3) Clearly print the RMA number on the outside of the shipping container.
- 4) Return to:

Triplett / Jewell Instruments  
850 Perimeter Road  
Manchester, NH 03103  
ATTN: Repair Dept.

## **8. Triplett Three Year Limited Warranty**

Triplett warrants instruments and test equipment manufactured by it to be free from defective material or workmanship and agrees to repair or replace such products which, under normal use and service, disclose the defect to be the fault of our manufacturing, with no charge within three years of the date of original purchase for parts and labor.



### **Triplett Three Year Limited Warranty (cont.)**

If we are unable to repair or replace the product, we will make a refund of the purchase price. Consult the Instruction Manual for instructions regarding the proper use and servicing of instruments and test equipment. Our obligation under this warranty is limited to repairing, replacing, or making refund on any instrument or test equipment which proves to be defective within three years from the date of original purchase.

This warranty does not apply to any of our products which have been repaired or altered by unauthorized persons in any way so as, in our sole judgment, to injure their stability or reliability, or which have been subject to misuse, abuse, misapplication, negligence, accident or which have had the serial numbers altered, defaced, or removed. Accessories, including batteries and fuses, not of our manufacture used with this product are not covered by this warranty.

To register a claim under the provisions of this warranty, contact Triplett's Customer Service Department for a Return Authorization Number (RMA) and return instructions. No returned product will be accepted without an RMA number. Upon our inspection of the product, we will advise you as to the disposition of your claim.

**ALL WARRANTIES IMPLIED BY LAW ARE HEREBY LIMITED TO A PERIOD OF THREE YEARS FROM DATE OF PURCHASE, AND**

### **Triplett Three Year Limited Warranty (cont.)**

THE PROVISIONS OF THE WARRANTY ARE EXPRESSLY IN LIEU OF ANY OTHER WARRANTIES EXPRESSED OR IMPLIED.

The purchaser agrees to assume all liability for any damages and bodily injury which may result from the use or misuse of the product by the purchaser, his employees, or others, and the remedies provided for in this warranty are expressly in lieu of any other liability Triplett may have, including incidental or consequential damages. Some states (USA ONLY) do not allow the exclusion or limitation of incidental or consequential damages, so the above limitation or exclusion may not apply to you. No representative of Triplett / Jewell Instruments or any other person is authorized to extend the liability of Triplett in connection with the sale of its products beyond the terms hereof.

Triplett reserves the right to discontinue models at any time, or change specifications, price or design, without notice and without incurring any obligation.

This warranty gives you specific legal rights, and you may have other rights which vary from state to state.





850 Perimeter Road, Manchester, NH 03103  
PHONE: 800-TRIPLETT FAX: 603-622-2960

**[www.triplett.com](http://www.triplett.com)**