

**FULL HD PRO-GRADE  
LED COLOR MONITOR**

**0E-32LEDMON2**

For additional Capture  
information visit  
[www.adiglobaldistribution.com](http://www.adiglobaldistribution.com)  
Technical Support: 833-574-9124

**Capture**

# Contents

Contents .....	1
Safety .....	1
Cautions .....	3
FCC RF Interference Statement .....	4
Connections .....	5
Controls & Menu Operation .....	6
Mounting Guide .....	13
Accessories .....	14
Power Indicator / Modes of Operation .....	14
Dimensions .....	15
Specifications .....	16
Limited Warranty .....	17

# Safety

1. Read these instructions completely and comply with all requirements.
2. Retain these instructions for reference.
3. Comply with all instructions and warnings, both in this manual and on the product.
4. Disconnect the monitor from all power before cleaning. Use a damp cloth for cleaning; and do not use liquid or aerosol cleaners.
5. Never use the monitor in damp areas or near water.
6. Never place the monitor on an unstable surface; if the monitor falls it may cause serious damage to people or property.
7. When selecting a location for placement/installation please ensure:
  - A. To allow for sufficient ventilation leave a minimum distance of 4" around the monitor.
  - B. Never allow anything (e.g. paper, cloth, etc.) to obstruct the monitor ventilation openings.
  - C. Never allow an open flame source (e.g. lighted candles) near the monitor.

- D. If batteries are used, please dispose of all batteries as per local regulations.
  - E. Use the monitor in indoor environments as per the temperature and humidity specs.
8. The monitor should be operated from a power source indicated on the rear of the monitor.
  9. The 3wire grounding type plug [having a third (grounding) pin] used on this monitor is a safety feature. Do not power the monitor without a grounding-type plug.
  10. Do not place the monitor where people will walk on the cord or allow anything to rest on or rub against the power cord.
  11. If an extension cord is used to power the monitor, make sure that the total ampere usage of all the products plugged into the extension cord does not exceed the ampere rating of the extension cord nor the power rating of the outlet.
  12. To avoid the risk of fire or an electric shock resulting from contact with dangerous voltage points or damage to parts, never insert objects of any kind into the monitor cabinet slots. Never spill any kind of liquid on the monitor.
  13. Do not attempt to service this monitor yourself, as opening or removing the cover may expose you to dangerous voltage points or other risks.
  14. If any of the following occur, disconnect the power to the monitor and refer servicing to qualified service personnel:
    - A. The power cord or plug is damaged or frayed.
    - B. If liquid has been spilled into the monitor.
    - C. If the monitor has been exposed to rain, water or other liquids.
    - D. If the monitor does not operate as expected as per the operating instructions. Adjust only those controls as described in the operating instructions; improper adjustment of other controls may cause the monitor to become inoperative and may void the warranty.
    - E. If the monitor has been dropped or the cabinet has been damaged.
    - F. If the monitor exhibits a distinct change in performance, indicating a need for service.

**Please note:**

The power supply cord is used as the main disconnect device. Ensure that the power outlet is located/installed near the monitor and is easily accessible.

# Cautions

## CAUTION TO SERVICE PERSONNEL

POWER SUPPLY CORD IS USED AS MAIN POWER DISCONNECT DEVICE IN THIS PRODUCT. UNPLUG THIS PRODUCT FROM THE WALL OUTLET BEFORE REMOVING THE BACK COVER AND SERVICING.

### 1. Never open the monitor case

Only specially qualified personnel should open the case. No user serviceable parts inside.

### 2. Do not use in environments that may cause hazards.

To prevent electrical shock or a fire hazard, do not expose the monitor to rain or moisture. This monitor is designed to be used in a residential or commercial environment. Do not subject the monitor to excessive vibration or dust, or to corrosive gases.

### 3. Keep in a well-ventilated location .

Ventilation slots are provided on the cabinet to control the internal temperature of the monitor. Do not cover these ventilation holes or place anything on the unit which might block those slots.

### 4. Avoid excessive heat.

Avoid placing the monitor in direct sunshine or near a heating appliance.

### 5. To eliminate eye fatigue.

Do not use the monitor against a bright background or where sunlight and other light sources will shine directly on the monitor.

### 6. Be careful of heavy objects .

Neither the monitor itself nor any other heavy object should rest on the power cord. Damage to a power cord can cause fire or electrical shock.

## FCC RF Interference Statement

This equipment has been tested and found to comply with the limits for a Class B digital device, pursuant to Part 15 of the FCC Rules. These limits are designed to provide reasonable protection against harmful interference in a residential installation.



This equipment generates, uses, and can radiate radio frequency energy and, if not installed and used in accordance with the instructions, may cause harmful interference to radio communications. However, there is no guarantee that interference will not occur in a particular installation.

If this equipment causes harmful interference to radio or television reception, which can be determined by turning the equipment off and on, the user is encouraged to try to correct the interference by one or more of the following measures.

- Reorient or relocate the receiving antenna.
- Increase the space between the equipment and receiver.
- Connect the equipment into an outlet on a circuit different from that to which the receiver is connected.
- Only a shielded interface cable should be used.

Finally, any changes or modifications to the equipment by the user not expressly approved by the grantee or manufacturer could void the user's authority to operate such equipment.

### DOC Compliance Notice

This digital apparatus does not exceed the Class A limit for radio noise emissions from digital apparatus set out in the radio interference regulation of Canadian Department of Communications.

### CE Compliance

This monitor complies with the basic protection requirements of the Electromagnetic Compatibility (EMC) Directive 2004/108/EC for electrical and electronic equipment imported into the European Union (EU):



The electromagnetic disturbance generated by the apparatus does not exceed the level specified in the harmonized EMC Standards for this type of apparatus. It has a level of immunity to the electromagnetic disturbance to be expected in its intended use, and should operate without unacceptable degradation of its specified performance.

# Connections

## Back View of Monitor

Connector panel is located on the underside of the case rear projection, just above the stand.



Detailed View of the Connector Panel.

Only use a properly, grounded, three wire cord appropriate for the local power system.

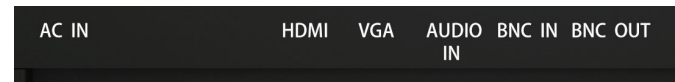

## Remote control

The remote control offers various shortcuts and added convenience.



# Controls & Menu Operation

## Control Keys / Buttons

Buttons are located on the right side of the Bezel on OE-32LEDMON2 model. Source Auto detection function when there is/are source(s) connect to the monitor, monitor will auto detect the source(s) and auto select the desired source. The source should be selected manually when there is more than one source connected to the monitor.



### A. "SOURCE" button

To change the input selection, press SOURCE to display the pop-up menu, use up/down to highlight the desired source, then press left/right to complete the selection.

To verify the current input selection, press SOURCE to display the pop-up, then press MENU again to dismiss the pop-up.

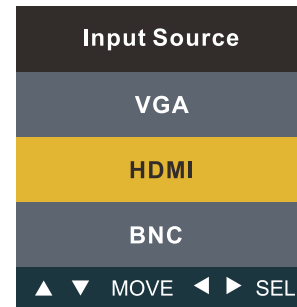

- Press the button to display all the signal channel menus.

When Main MENU display as confirmation key during the OSD operation.

### B. "MENU" button

- Press the button to show the OSD main menu.
- Press the button to exit OSD menu.

### C. "LEFT" button

- Press LEFT button, volume down.
- Press the LEFT button to scroll the cursor to desired function.

### D. "RIGHT" button

- Press RIGHT button, volume increase.

### E. "DOWN" button

- Press the button to scroll the cursor to desired function.
- Press the DOWN to decrease the value of selected function in sub OSD menu.

### F. "UP" button

- Press the button to scroll the cursor to desired function.
- Press the button to increase the value of selected function in sub OSD menu.

### G. "POWER" button

- Press the button to turn ON or turn OFF the monitor.

### Volume



Press ◀ ▶ buttons to adjust volume on monitor.

Press ◀ ▶ buttons to adjust volume on remote controller.

### One-Touch Button 4:3/16:9 Scale Toggle

Press ▼ button to adjust the aspect ratio of the picture 4:3/16:9 scale toggle.



## Picture Menu

The “PICTURE” menu is for adjusting the image appearance and parameters. The Picture menu is the same for BNC/CVBS and HDMI; the Picture menu options differ for VGA.

### Picture Menu (BNC/CVBS & HDMI)

Press the MENU button to bring the menu on screen, and then the right/left buttons to move up along the main menu selections to choose the PICTURE menu. Press up/down to move between the left side main menu selector into the window of menu choices and parameters.

Use the left & right buttons to move the yellow highlighted sub-menu selection within the sub- menu. Pressing the right & left buttons will adjust the value of the highlighted item. Press the MENU button to exit the sub-menu and return to the main menu selector.

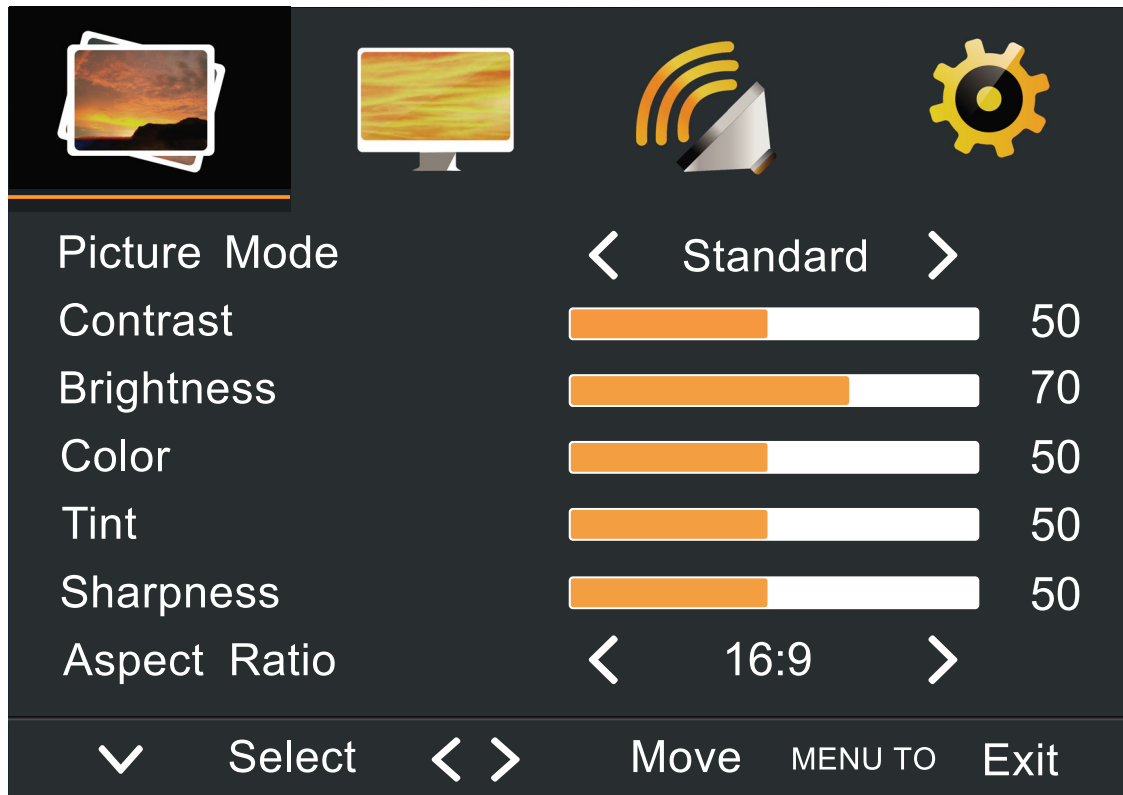

To exit the menu system, press the MENU. Settings will remain as they appear on screen.

## Adjustments

**Picture mode:** Choose for User/Dynamic/Standard/Mild for most pleasing image based on ambient light.

**Contrast:** Adjusts the range of difference between light and dark areas of the picture.

**Brightness:** Adjusts the overall picture intensity.

**Color:** Adjust the color saturation 0-100.

**Tint:** Increase or decrease the intensity of colors in the image.

**Sharpness:** Change the balance between image detail (resolution) and degree of transition between areas of differing brightness.

**Aspect Ratio:** Choose between SD 4:3 and HD 16:9 aspect ratio. If analog images appear stretched use 4:3 scaling.

**Noise Reduction:** Reduce noise of the display image (LOW/MID/HIGH/OFF).

**Color Temp:** Adjust color reproduction: choose between Normal/Warm/User/Cool.

To set custom color temperature (R.G.B values), select "USER" to set color temperature. Keep pushing "DOWN" button on the monitor or the remote controller, then you will see Red, Green and Blue option.

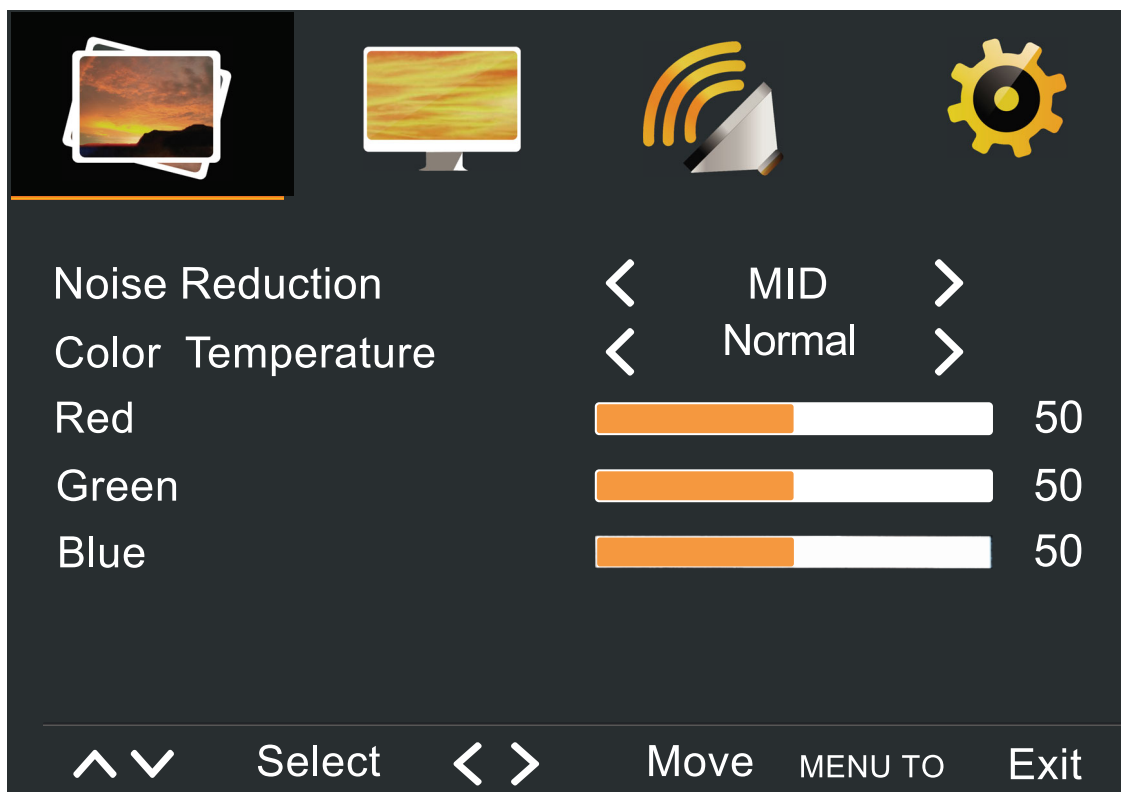

## Audio Menu

Press the MENU button to bring the menu on screen, and then left/right buttons to move along the menu selections to highlight the AUDIO menu. Press up/down to move between the left side main menu selector into the window of menu choices and parameters.

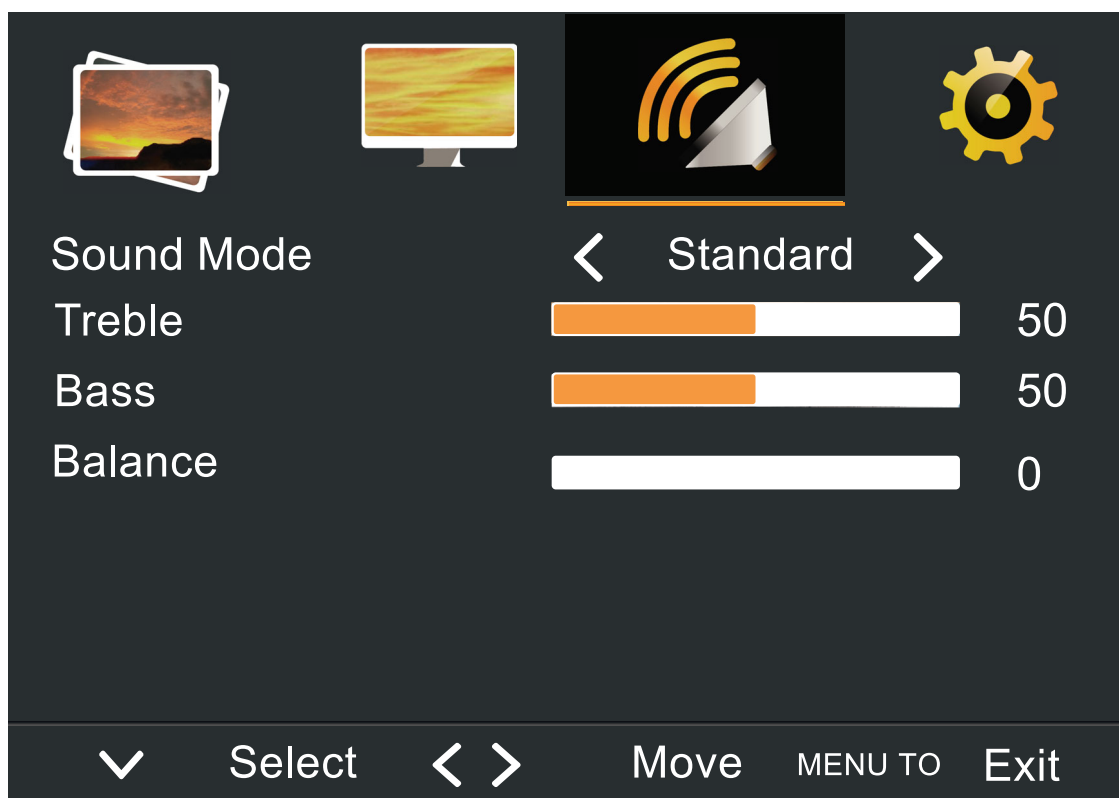

Use the left & right buttons to move the yellow highlighted sub-menu selection within the sub-menu. Pressing the right & left buttons will adjust the value of the highlighted item. Press the MENU button to exit the sub-menu and return to the main menu selector.

To exit the menu system, press the MENU.

## Adjustments

**Sound Mode:** Select one of the presets (User, Sport, Movie, Music, Standard).

**Treble:** Boost/limit high frequency tones (0-100).

**Bass:** Boost/limit low frequency tones (0-100).

**Balance:** Change relative volume between left and right speakers.

## OSD Menu

Press the MENU button to bring the menu on screen, and then left/right buttons to move along the menu selections to highlight the OSD menu. Press up/down to move the left side main menu selector into the window of menu choices and parameters.

Use the left & right buttons to move the yellow highlighted sub-menu selection within the sub-menu. Pressing the left & right buttons will adjust the value of the highlighted item. Press the MENU button to exit the sub-menu and return to the main menu selector.

To exit the menu system, press MENU.

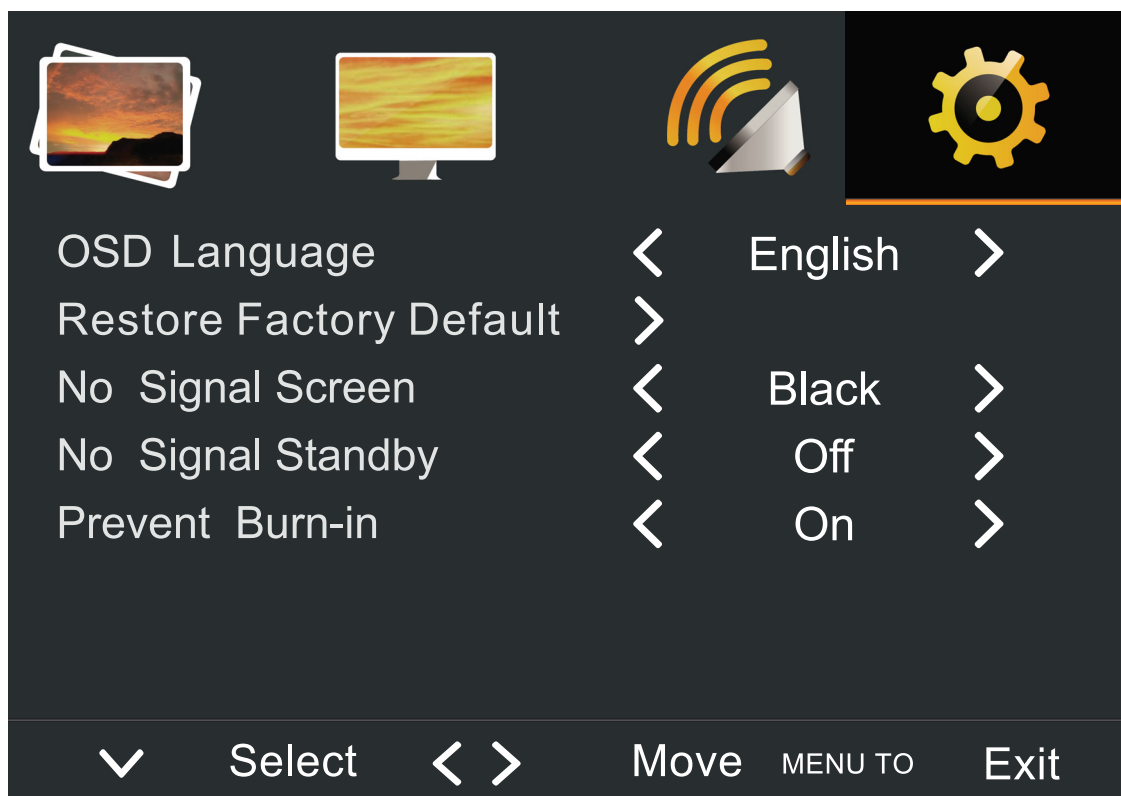

**OSD Language:** Choose OSD display language from English/French/Spanish Italian/Netherlands/Polish/Czech/Danish.

**Restore User Default:** Reset the monitor settings to the factory default.

**No Signal Screen:** Show the color when there is "No Signal" (Blue/Black).

**No Signal Standby:** Show the color when there is "No Signal" (On/Off).

**Prevent Burn-in:** Set periodic image retention (On/Off).

## Computer Menu (VGA model Only)

Press the MENU button to bring the menu on screen, and then left/right buttons to move along the menu selections to highlight the GEOMETRY menu. Press up/down to move between the left side main menu selector into the window of menu choices and parameters.

Use the left & right buttons to move the yellow highlighted sub-menu selection within the sub-menu. Pressing the left & right buttons will adjust the value of the highlighted item. Press the MENU button to exit the sub-menu and return to the main menu selector.

To exit the menu system, press the SOURCE button twice.



## Adjustments

**Auto Adjust:** Press Vol Right button to automatically adjust settings to match input signal parameters.

**H- Position:** OSD horizontal position on the screen.

**V-Position:** OSD vertical position on screen.

**Clock:** Relative adjustment of horizontal scan rate.

**Phase:** Reduce video distortion and instability components.

# Mounting Guide

## Wall or Other Mounting with VESA Standard

**CAUTION** The wall mount must bear a minimum of five times the monitor's net weight. To mount your MONITOR to the wall or another surface, you need to purchase a VESA wall mount. Use four HMΦ6.0x10 mm screws (the base attachment screws removed in step 1 below are HMΦ 6.0x 10mm) to attach the mount. The monitor mount VESA hole pattern is (OE-32LEDMON2 (200mm x 200mm))

**Note:** Metric (HMΦ 6.0 x10mm) is the type screw that should be used (do not use longer screws or the monitor may be damaged).

1. Before mounting the monitor, remove the base riser (vertical portion of the base) by removing the two screws near the top with a screwdriver. Then the base and the riser can be removed. In order to prevent losing these screws, we suggest replacing the screws in their original holes.
2. Attach the VESA mount (OE-32LEDMON2 (200mm x 200mm)) plate to the rear of the monitor and follow all of the instructions provided with the mount to complete the mounting process.



## Accessories



Power Cable  
Qty: 1



HDMI Cable  
Qty: 1



VGA Cable  
Qty: 1



Audio Cable  
Qty: 1



IR Remote  
Qty: 1

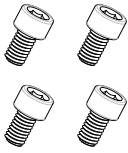

Screws for Mounting  
Monitor Screws  
Type: HMΦ6.0x10mm  
Qty: 4

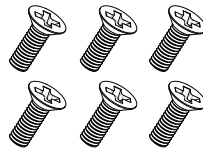

Screws for Securing  
Base of Stand Screws  
Type: KMΦ4.0x10mm  
Qty: 6

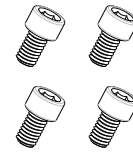

Screws for Installing  
Monitor Stand Screws  
Type: HMΦ6.0x10mm  
Qty: 4



Allen Wrench  
Qty: 1

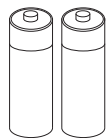

Batteries  
Qty: 2

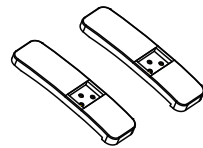

Base of Stands  
Qty: 2

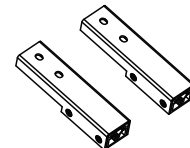

Stand Supports  
Qty: 2



User Manuals  
Qty: 2

## Power Indicator / Modes of Operation

### LED Indicator

LED is off when power is off, LED glows blue when power is on, LED glows red when monitor is sleep/standby model. The power management feature of the monitor is designed for security surveillance applications. When there is no video, the monitor remains ON to be instantly ready to display video when the source is changed or if a PC changes state from sleep/standby to active mode. A floating “No Signal” box moves slowly across the screen until video is restored.

# Dimensions

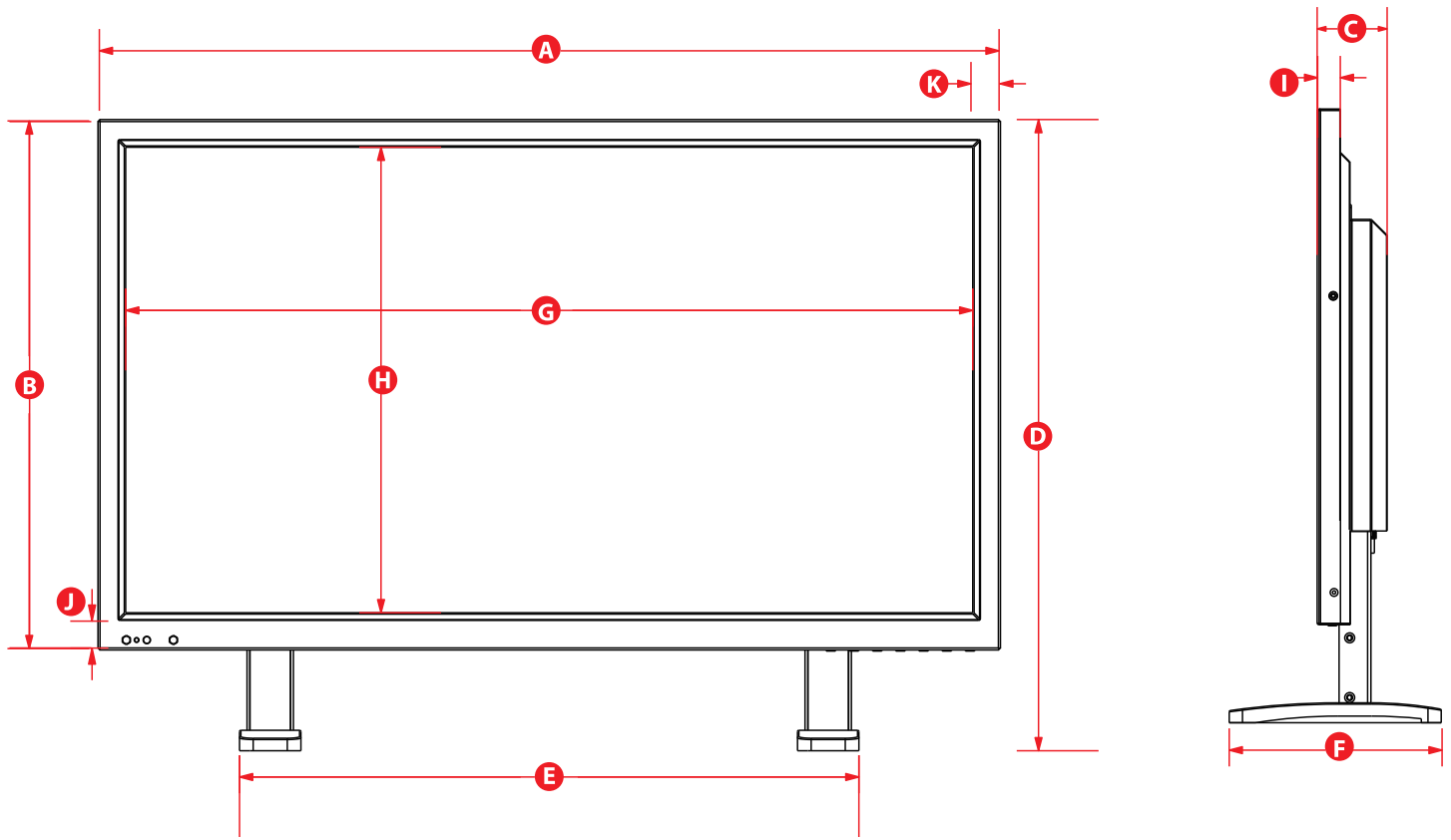

	Model	OE-32LEDMON2	
Letter	Dimension	mm	inch
<b>A</b>	Width of monitor body	737	29
<b>B</b>	Height of monitor body	441.9	17.4
<b>C</b>	Depth of monitor body	54.4	2.1
<b>D</b>	Height of monitor on base	515.9	20.3
<b>E</b>	Width of base	434	17
<b>F</b>	Depth of base	159.8	6.3
<b>G</b>	Width of viewable area	700	27.5
<b>H</b>	Height of viewable area	394.5	15.5
<b>I</b>	Thickness of monitor	18.4	0.72
<b>J</b>	Bottom bezel width	26.3	1
<b>K</b>	Side bezel width	18.5	0.72



# Specifications

<b>Model</b>	<b>OE-32LEDMON2</b>
<b>Screen Diagonal Dimension (inches)</b>	31.5
<b>Viewable Area W x H (inches)</b>	27.5*15.47
<b>Led Type</b>	LED
<b>Pixel Pitch (mm)</b>	0.36x0.36
<b>Screen Maximum Resolution</b>	1920x1080
<b>Display Resolutions</b>	720x400;640x480;800x600;1024x768;1280x1024;1920x1080
<b>Supported Input Resolutions</b>	720x400;640x480;800x600;1024x768;1280x1024;1920x1080
<b>Refresh Rate (Hz)</b>	60
<b>Color Depth (M)</b>	16.7
<b>Brightness (cd/m<sup>2</sup>)</b>	300
<b>Auto Adjust</b>	Yes
<b>Monitor Aspect Ratio</b>	16:9
<b>Display Aspect Ratio</b>	OSD selectable 16:9 or 4:3
<b>Horizontal TV Lines</b>	1080
<b>Contrast Ratio</b>	3000:1SCR
<b>Response Time (ms)</b>	5(GTG)
<b>View Angle H/V (degrees)</b>	178° x 178°/CR>10
<b>Digital Video Inputs</b>	HDMI up to 1920 x 1080
<b>Analog Video In/Out</b>	VGA up to 1920 x 1080, BNC CVBS looping
<b>Audio Inputs (stereo)</b>	1x3.5mm mini-jack
<b>Speakers (W)</b>	2 x 5
<b>Stand-by (W)</b>	<0.5
<b>Power Consumption</b>	50W Typical
<b>Monitor Body Dimensions (inches)</b>	29*17.4 *2.1
<b>Dimension Monitor + Stand (inches)</b>	29*20.3 *6.3
<b>Panel Surface</b>	Matte black
<b>Case &amp; Stand Material</b>	Metal + Aluminum (removable stand)
<b>VESA Mounting Pattern (mm)</b>	200 x 200
<b>Base/Stand Included</b>	Yes
<b>Base/Tilt Angle</b>	-5°-15°
<b>Weight Cabinet Only (lb.)</b>	21.1
<b>Weight Cabinet + Base Stand (lb.)</b>	22.9
<b>Power Supply (internal)</b>	AC 100 - 240V-50/60Hz 1.1A
<b>Operating Temperature</b>	0°C-40°C / 32°F-104 °F
<b>Storage Temperature</b>	-20°C-50°C /-4°F-122°F
<b>Operating Humidity</b>	10-90%
<b>Accessories</b>	Power cable/HDMI cable/VGA cable/Audio cable/IR Remote/Batteries Allen wrench/Screws/Base of stand/Stand support/User manuals
<b>Rack Mount Screw Size (mm)</b>	Screws for Mounting Monitor, Screws Type: HMΦ6.0x10mm/4pcs Screws for Securing Base of Stand, Screws Type: KMΦ4.0x10mm/6pcs Screws for Installing Monitor Stand, Screws Type: HMΦ6.0x10mm/4pcs
<b>Certifications</b>	CE/FCC/ROHS/HDMI/UL/WEEE/REACH
<b>Warranty</b>	30 Months

# Limited Warranty

## 1. Limited Warranty

### A. General

Subject to the terms and conditions of this Limited Warranty, from the date of sale through the period of time for product categories specified in Section 1(b), ADI warrants its Capture products to be free from defects in materials and workmanship under normal use and service, normal wear and tear excepted. Except as required by law, this Limited Warranty is only made to Buyer and may not be transferred to any third party.

ADI shall have no obligation under this Limited Warranty or otherwise if:

- (I) The product is improperly installed, applied or maintained;
- (II) The product is installed outside of stated operating parameters, altered, or improperly serviced or repaired;
- (III) Damage is caused by outside natural occurrences, such as lightning, power surges, fire, floods, acts of nature, or the like.
- (IV) Defects resulting from unauthorized modification, misuse, vandalism, or other causes unrelated to defective materials or workmanship, or failures related to batteries of any type used in connection with the products sold here under.

ADI only warrants those products branded as Capture products and sold by ADI. Any other products branded by third parties are warranted by the third party manufacturer for a period as defined by the third party manufacturer, and ADI assigns to Buyer those warranties and only those warranties extended by such third party manufacturers or vendors for non-ADI branded products. ADI does not itself warrant any non-ADI branded product and sells only on an as is basis in accordance with ADI's terms and conditions of sale.

## B. Specific Warranties for Product Categories

<b>Product Categories</b>	<b>Warranty</b>
Monitors	30 months
Capture Advance Analog Cameras	36 months
DVR's, NVR's (excluding HDD)	36 months
Capture Advance IP Cameras	36 months

## 2. Exclusion of Warranties, Limitation of Liability

THERE ARE NO WARRANTIES OR CONDITIONS, EXPRESS OR IMPLIED, OF MERCHANTABILITY, OR FITNESS FOR A PARTICULAR PURPOSE OR OTHERWISE, WHICH EXTEND BEYOND THE DESCRIPTION ON THE FACE HEREOF. TO THE FULLEST EXTENT PERMITTED BY LAW, IN NO CASE SHALL ADI BE LIABLE TO ANYONE FOR ANY (I) CONSEQUENTIAL, INCIDENTAL, INDIRECT, SPECIAL, OR PUNITIVE DAMAGES ARISING OUT OF OR RELATING IN ANY WAY TO THE PRODUCT AND. OR FOR BREACH OF THIS OR ANY OTHER WARRANTY OR CONDITION, EXPRESS OR IMPLIED, OR UPON ANY OTHER BASIS OF LIABILITY WHATSOEVER, EVEN IF THE LOSS OR DAMAGE IS CAUSED BY ADI'S OWN NEGLIGENCE OR FAULT AND EVEN IF ADI HAS BEEN ADVISED OF THE POSSIBILITY OF SUCH LOSSES OR DAMAGES.

Any product description (whether in writing or made orally by ADI or ADI's agents), specifications, samples, models, bulletin, drawings, diagrams, engineering sheets, or similar materials used in connection with the Buyer's order are for the sole purpose of identifying ADI's products and shall not be construed as an express warranty or condition. Any suggestions by ADI or ADI's agents regarding use, applications or suitability of the products shall not be construed as an express warranty or condition unless confirmed to be such in writing by ADI. ADI does not represent that the products it sells may not be compromised or circumvented; that the products will prevent any personal injury or property loss by burglary, robbery, fire or otherwise, or that the products will in all cases provide adequate warning or protection. Buyer understands and will cause its customer to understand that a properly installed and maintained product is not insurance or guarantee that such will not cause or lead to personal injury or property loss. CONSEQUENTLY ADI SHALL HAVE NO LIABILITY FOR ANY PERSONAL INJURY, PROPERTY DAMAGE OR OTHER LOSS BASED ON ANY CLAIM AT ALL INCLUDING A CLAIM THAT THE PRODUCT FAILED TO GIVE WARNING. However, if ADI is held liable whether directly or indirectly for any loss or damage with respect to the products it sells, regardless of cause or origin, its maximum liability shall not in any case exceed the purchase price of the product, which shall be fixed as liquidated damages and not as a penalty and shall be the complete and exclusive remedy against ADI. FOR THE AVOIDANCE OF DOUBT, ADI DOES NOT SEEK HEREUNDER TO EXCLUDE OR RESTRICT ITS LIABILITY IN RELATION TO (I) FRAUD, (II) DEATH OR PERSONAL INJURY DIRECTLY RESULTING FROM ITS NEGLIGENCE OR (III) ANY MATTER IN RESPECT OF WHICH, BY LAW, IT IS NOT PERMITTED TO RESTRICT ITS LIABILITY.

### **3. Limitation on Liability to Buyer's Customers**

Buyer agrees to limit liability to its customers to the fullest extent permitted by law. Buyer acknowledges that ADI shall only be deemed to give consumers of its products such statutory warranties as may be required by law and at no time shall Buyer represent to its customers and/or users of ADI products that ADI provides any additional warranties. By accepting the products, to the fullest extent permitted by law, Buyer assumes all liability for, and agrees to indemnify and hold ADI harmless against and defend ADI from, any and all suits, claims, demands, causes of action and judgments relating to damages, whether for personal injury or to personal property, suffered by any person, firm, corporation or business association, including but not limited to, Buyer's customers and/or users of the products because of any failure of the products to detect and/or warn of the danger for which the goods were designed or any other failure of the products whether or not such damages are caused or contributed to by the sold or joint concurring negligence or fault of ADI.

## 4. Returns

Subject to the terms and conditions listed below, during the applicable warranty period, ADI will replace Product or provide a credit at purchase at its sole option free of charge any defective products returned prepaid. Any obligations of ADI to replace Limited Lifetime warranty products pursuant to this warranty which result from defect are limited to the availability of replacement product. ADI reserves the right to replace any such products with the then currently available products, or provide a credit in its sole discretion. In the event Buyer has a problem with any ADI product, please call your local ADI branch for return instructions:

[www.adiglobaldistribution.com](http://www.adiglobaldistribution.com)

Be sure to have the model number and the nature of the problem available. In the event of replacement, the return product will be credited to Buyer's account and a new invoice issued for the replacement item. ADI reserves the right to issue a credit only in lieu of replacement.

If any Capture product is found to be in good working order or such product's inability to function properly is a result of user damage or abuse, the product will be returned to Buyer in the same condition as received and Buyer shall be responsible for any return freight changes.

## 5. Governing Law

The laws of State of New York apply to this Limited Warranty.

## 6. Miscellaneous

Where any term of this Limited Warranty is prohibited by such laws, it shall be null and void, but the remainder of the Limited Warranty shall remain in full force and effect.

For additional Capture  
information visit  
[www.adiglobaldistribution.com](http://www.adiglobaldistribution.com)  
Technical Support: 833-574-9124

**Capture**



[www.adiglobaldistribution.com](http://www.adiglobaldistribution.com)



0E-32LEDMON2

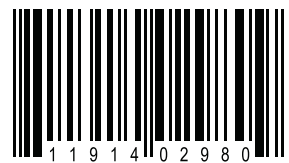

8 1 1 9 1 4 0 2 9 8 0 9