



# Honeywell

# Honeywell 30 Series

Network Video Recorder

HN300401xx

HN300802xx

HN301602xx





(X: may be any alphanumeric character for HDD information)

---

## User Guide

---

## Cautions and Warnings

	<b>CAUTION</b> RISK OF ELECTRIC SHOCK DO NOT OPEN		 THIS SYMBOL INDICATES THAT DANGEROUS VOLTAGE CONSTITUTING A RISK OF ELECTRIC SHOCK IS PRESENT WITHIN THE UNIT.
CAUTION: TO REDUCE THE RISK OF ELECTRIC SHOCK, DO NOT REMOVE THE COVER. NO USER-SERVICEABLE PARTS INSIDE. REFER SERVICING TO QUALIFIED SERVICE PERSONNEL.			 THIS SYMBOL INDICATES THAT IMPORTANT OPERATING AND MAINTENANCE INSTRUCTIONS ACCOMPANY THIS UNIT.



**WARNING** Installation and servicing should be performed only by qualified and experienced technicians to conform to all local codes and to maintain your warranty.



**WARNING** Use only with the supplied power cable. Power output: 50W for 4 channels / 120W for 8 channels / 200W for 16 channels (1-8 channels cannot be exceeded 100W and 9-16 channels cannot be exceeded 100W) PoE 802.3at in total.

**CAUTION** The Honeywell product uses a 3.0V CR1220 lithium battery as the power supply for its internal real-time clock (RTC). Low battery power affects the operation of the RTC, causing it to reset at every power-up.

Risk of explosion if the battery is incorrectly replaced.

Dispose of used batteries according to local regulations or the battery manufacturer's instructions.

Replace only with an identical battery or a battery which is recommended by Honeywell.

## Regulatory Statements

### FCC Compliance Statement

**Information to the User:** This equipment has been tested and found to comply with the limits for a Class A digital device, pursuant to part 15 of the FCC Rules. These limits are designed to provide reasonable protection against harmful interference when the equipment is operated in a commercial environment. This equipment generates, uses, and can radiate radio frequency energy and, if not installed and used in accordance with the instruction manual, may cause harmful interference to radio communications. Operation of this equipment in a residential area is likely to cause harmful interference in which case the user will be required to correct the interference at his own expense. Changes or modifications not expressly approved by the party responsible for compliance could void the user's authority to operate the equipment.

**CAUTION:** This is a Class A product. In a domestic environment, this product may cause radio interference in which case the user may be required to take adequate measures.

This Class A digital apparatus complies with Canadian ICES-003.

Please visit <https://mywebtech.honeywell.com/Home> to check the complete FCC documents.

## **Manufacturer's Declaration of Conformance**

### **North America**

The equipment supplied with this guide conforms to UL 62368-1 and CSA C22.2 No. 62368-1.

### **Europe**

The manufacturer declares that the equipment supplied is compliant with the European Parliament and Council Directive on the restriction of the use of certain hazardous substances in electrical and electronic equipment (2015/863/EU), the Low Voltage Directive (2014/35/EU) and the essential requirements of the EMC directive (2014/30/EU), conforming to the requirements of standards EN 55032 for emissions, EN 50130-4 for immunity, and EN 62368-1 for electrical equipment safety.

## **Waste Electrical and Electronic Equipment (WEEE)**



**Correct Disposal of this Product** (applicable in the European Union and other European countries with separate collection systems).

This product should be disposed of, at the end of its useful life, as per applicable local laws, regulations, and procedures.

## **Eurasian Conformity (EAC) RoHS**



## **General Data Protection Regulation**

Please be aware that this product can store personal data.

Personal data is protected by the General Data Protection Regulation (2016/679) in Europe and therefore the owners of personal data have obtained certain rights thanks to this regulation.

We strongly advise you to be fully aware of these owner ("data subjects") rights as well as which limitations you have to obey regarding the use and distribution of this data.

Further details can be found on the GDPR website of the EU:

[https://ec.europa.eu/commission/priorities/justice-and-fundamental-rights/data-protection/2018-reform-eu-data-protection-rules\\_en](https://ec.europa.eu/commission/priorities/justice-and-fundamental-rights/data-protection/2018-reform-eu-data-protection-rules_en)

## **Regulation (EC) No 1907/2006**

According to Article 33 of Reach Regulation be informed that the substances listed below may be contained in these products above the threshold level of 0.1% by weight of the listed article.

Product	Part Name	Substance Name	CAS Number
HN300401xx	Solder paste(U1022)	Lead	7439-92-1
	Solder Wire(Q1018)		
	Solder paste(D1097)		
	Wafer Passivation_Glass(D1097)		
	Smd Diode-Body(D1029,D016)		
	Solder paste(D1096,D1099,D1101,D1103)		
	WAFER(D1096,D1099,D1101,D1103)		
	Body(D1071, D1077)		
HN300802xx	BUZZER_Ceramic wafer(BZ1)	Lead	9439-92-1
	FAN_Brass metal		
	Buzzer(BZ1)		
	Solder paste(U1022, D1015, D1005, D1006, D1008, D1009, D1011, D1012, D101)		
	Wafer Passivation_Glass(D1015)		
	Smd Diode-Body(D1029)		
	WAFER(D1005, D1006, D1008, D1009, D1011, D1012, D101)		
	Body(D1071, D1077)		
HN301602xx	Buzzer(BZ1)	Lead	9439-92-1
	Solder paste(U1022, D1015, D1005, D1006, D1008, D1009, D1011, D1012, D101)		
	Wafer Passivation_Glass(D1015)		
	Smd Diode-Body(D1029)		
	WAFER(D1005, D1006, D1008, D1009, D1011, D1012, D101)		
	Body(D1071, D1077)		

## Important Safeguards

Read and keep these instructions.

- Please ensure that your installation area can safely support the weight of the unit.
- Do not drop the unit or subject it to physical shock.
- Avoid operating or storing the unit in extremely humid, dusty, hot/cold environments, where the operating temperature is outside the recommended range of 14°F to 131°F (-10°C to 55°C).
- Avoid operating the unit close to sources of powerful electromagnetic radiation, such as radio or TV transmitters.

- Ensure to connect the power cord to a socket-outlet with earthing connection, or equivalent.
- The product is only to be connected to PoE network without routing to outside plant.

## Safety Instructions

**Before installing or operating the unit, read and follow all instructions. After installation, retain the safety and operating instructions for future reference.**

1. **HEED WARNINGS** - Adhere to all warnings on the unit and in the operating instructions.
2. **INSTALLATION**
  - Install in accordance with the manufacturer's instructions.
  - Installation and servicing should be performed only by qualified and experienced technicians to conform to all local codes and to maintain your warranty.
  - Any wall or ceiling mounting of the product should follow the manufacturer's instructions and use a mounting kit approved or recommended by the manufacturer.
3. **POWER SOURCES** - This product should be operated only from the type of power source indicated on the marking label. If you are not sure of the type of power supplied to your facility, consult your product dealer or local power company.
4. **MOUNTING SYSTEM** - Use only with a mounting system recommended by the manufacturer or sold with the product.
5. **ATTACHMENTS/ACCESSORIES** - Do not use attachments/accessories not recommended by the product manufacturer as they may result in the risk of fire, electric shock, or injury to persons.
6. **CLEANING** - Do not use liquid cleaners or aerosol cleaners. Use a damp cloth for cleaning.
7. **SERVICING** - Do not attempt to service this unit yourself. Refer all servicing to qualified service personnel.
8. **REPLACEMENT PARTS** - When replacement parts are required, be sure the service technician has used replacement parts specified by the manufacturer or have the same characteristics as the original part. Unauthorized substitutions may result in fire, electric shock or other hazards. Using replacement parts or accessories other than the original manufacturers may invalidate the warranty.

## Warranty and Service

Subject to the terms and conditions listed on the product warranty, during the warranty period Honeywell will repair or replace, at its sole option, free of charge, any defective products returned prepaid.










In the event you have a problem with any Honeywell product, please call Customer Service for assistance or to request a **Return Merchandise Authorization (RMA)** number.










Be sure to have the model number, serial number, and the nature of the problem available for the technical service representative.

Prior authorization must be obtained for all returns, exchanges, or credits. **Items shipped to Honeywell without a clearly identified Return Merchandise Authorization (RMA) number may be refused.**

## List of Symbols

The following is a list of symbols that might appear on the NVR.

Symbol	Explanation
	The WEEE symbol. This symbol indicates that when the end-user wishes to discard this product, it must be sent to separate collection facilities for recovery and recycling. By separating this product from other household-type waste, the volume of waste sent to incinerators or landfills will be reduced, and thus natural resources will be conserved.
	The UL compliance logo. This logo indicates that the product has been tested and is listed by the Underwriters Laboratories.
	The FCC compliance logo. This logo indicates that the product conforms to Federal Communication's Commission compliance standards.
	The direct current symbol. This symbol indicates that the power input/output for the product is direct current.
	The alternating current symbol. This symbol indicates that the power input/output for the product is alternating current.
	The LDPE symbol. This symbol indicates that this product is made of Low-Density Polyethylene (LDPE).
	The Direct Current symbol. This symbol indicates that the product operates from a 12 V direct current.
	The Lead-free symbol. This symbol indicates that the product does not contain lead (Pb).
	The CCC compliance logo. This logo indicates that the product conforms with the China

	Compulsory Certification guidelines.
	The Environment Friendly Use-period symbol. This symbol indicates the length of time that this electronic product can be used without harming the environment.
	The RCM Compliance symbol. This symbol indicates that the product conforms with the Australian RCM guidelines.
	The TVU Lab symbol. This symbol indicates that the product has been safety tested by the TUV Lab.
	The Direct Current symbol. This Direct Current symbol indicates that the product operates direct current.
	This symbol indicates that the product is to be used indoors.
	The CE Compliance logo. This logo indicates that the product conforms to the relevant guidelines/standards for the European Union harmonization legislation.
	The Protective Earth symbol. This symbol indicates that the marked terminal is intended for connection to the protective earth/grounding conductor.
	This symbol is used to direct attention to important information.
	This symbol warns that the corresponding action could result in an electric shock.
	This symbol indicates On/Standby functionality of the corresponding control/button/switch.
	Eurasian Conformity (EAC) RoHS

# Regulatory Information

The regulatory information herein might vary according to the model you purchased. Some information is only applicable for the country or region where the product is sold.

## FCC Information



### CAUTION

Changes or modifications not expressly approved by the party responsible for compliance could void the user's authority to operate the equipment.

### FCC conditions

This device complies with part 15 of the FCC Rules. Operation is subject to the following two conditions:

- This device may not cause harmful interference.
- This device must accept any interference received, including interference that may cause undesired operation.

### FCC compliance

This equipment has been tested and found to comply with the limits for a digital device, pursuant to part 15 of the FCC Rules. This equipment generates, uses, and can radiate radio frequency energy and, if not installed and used in accordance with the instructions, may cause harmful interference to radio communication.

- For class A device, these limits are designed to provide reasonable protection against harmful interference in a commercial environment. Operation of this equipment in a residential area is likely to cause harmful interference in which case the user will be required to correct the interference at his own expense.
- For class B device, these limits are designed to provide reasonable protection against harmful interference in a residential installation. However, there is no guarantee that interference will not occur in a particular installation. If this equipment does cause harmful interference to radio or television reception, which can be determined by turning the equipment off and on, the user is encouraged to try to correct the interference by one or more of the following measures:
  - Reorient or relocate the receiving antenna.
  - Increase the separation between the equipment and receiver.
  - Connect the equipment into an outlet on a circuit different from that to which the receiver is connected.
  - Consult the dealer or an experienced radio / TV technician for help.

## Privacy Protection Notice

As the device user or the data controller, you might collect personal data or others such as face, fingerprints, car plate number, Email address, phone number and GPS and so on. You need to be in compliance with the local privacy protection laws and regulations to protect the legitimate right and interest of other people by implementing measures include but not limited to: providing clear and visible identification to inform data subject the existence of surveillance area and providing related contact.



# Table of Contents

<b>About This Document .....</b>	<b>xv</b>
Overview of Contents .....	xv
Special Fonts and Symbols.....	xv
How to Use This Document .....	xv
<b>1 Introduction .....</b>	<b>1</b>
Overview of the Network Video Recorder.....	1
Features of the Network Video Recorder.....	1
Network Video Recorder Components .....	2
Using the On-screen Keyboard.....	4
<b>2 Getting Started.....</b>	<b>6</b>
Connecting External Devices .....	6
Devices Connection .....	7
Starting and Shutting Down the NVR .....	8
Starting the NVR .....	8
Shutting Down/Reboot the NVR.....	8
Device Initialization.....	9
<b>3 Viewing Live Video .....</b>	<b>14</b>
About Live View .....	14
Live View Window.....	15
Toolbars .....	15
Shortcut Menu .....	17
Working with the PTZ Control Panel (If Applicable) .....	18
Configuring PTZ Settings.....	19
<b>4 Recording Video.....</b>	<b>20</b>
Manual Recording .....	20
Scheduled Recording.....	20
<b>5 Playing Back and Search Videos.....</b>	<b>22</b>
Playing Recording Clips.....	22
Searching Videos .....	23
Timeline Bar.....	25
Backing Up Video.....	27
To Back Up Using the Playback Timeline Bar .....	27
To Back Up Using the Main Tool Bar .....	27
<b>6 Settings.....</b>	<b>29</b>
Setting-Camera-Management .....	29
Change Password .....	29
Adding a Camera .....	31
Removing a Camera .....	33

Network .....	34
Camera Position.....	34
Setting-Camera-Media.....	35
Stream Management.....	35
Video .....	36
Audio.....	38
Setting-Camera-Schedule .....	38
Recording Options .....	38
Schedule .....	39
Setting-Camera-Image.....	41
Display .....	41
Image Adjustment.....	41
Setting-Camera-Motion Detection.....	42
Setting-Camera-PTZ settings.....	43
Setting-Event-Event.....	44
Creating an Event.....	44
Removing an Event.....	50
Setting-Event-Email.....	50
Setting-System-Information .....	50
Setting-System-Maintenance.....	52
Setting-System-Display.....	53
Setting-System-Log .....	55
Setting-User .....	56
Creating a User .....	58
Removing a User.....	59
Setting-Login/Logout.....	59
Setting-Storage .....	60
Creating a Volume.....	60
Verify .....	63
Settings-Network-IP.....	63
Settings-Network-Service.....	64
Settings-Network-P2P.....	65
<b>7 Management over a Web Console.....</b>	<b>74</b>
Before Getting Started.....	75
Login .....	75
Live View Screen .....	76
Camera List .....	77
Layout .....	78
Layout Contents .....	79
Time & Log out.....	79
Live View Window .....	80
PTZ Panel.....	81
Event Panel.....	81
Search Recording Clips Screen.....	83
Camera List .....	84

Layout .....	84
Playback Panel .....	85
Event Panel.....	85
Settings Screen.....	86

# Figures

- Figure 1-1 NVR Front Panel (HN300401xx) .....2
- Figure 1-2 NVR Front Panel (HN300802xx/HN301602xx) .....3
- Figure 1-3 NVR Back Panel (HN300401xx) .....3
- Figure 1-4 NVR Back Panel (HN300802xx/HN301602xx) .....4
- Figure 1-5 On-screen Keyboard .....5
- Figure 2-1 Devices Connection (HN300401xx).....7
- Figure 2-2 Devices Connection (HN300802xx/HN301602xx) .....7
- Figure 2-3 Main Menu .....9
- Figure 2-4 Shutdown .....9
- Figure 2-5 Device Initialization –Password Setup .....10
- Figure 2-6 Device Initialization-Language and Time Zone .....10
- Figure 2-7 Device Initialization-Search for Cameras .....11
- Figure 2-8 Device Initialization-Insert Cameras.....12
- Figure 2-9 Device Initialization-Creating Disks .....12
- Figure 2-10 Live View Screen .....13
- Figure 3-1 Live View Screen .....14
- Figure 3-2 .....15
- Figure 3-3 Main Toolbar .....15
- Figure 3-4 Camera Toolbar .....16
- Figure 3-5 Shortcut Menu .....17
- Figure 3-6 PTZ Control Panel.....18
- Figure 3-7 PTZ Settings.....19
- Figure 4-1 Scheduled Recording .....20
- Figure 4-2 Scheduled Recording .....21
- Figure 5-1 Camera Toolbar-Playing Recording Clips.....22
- Figure 5-2 Credentials.....23
- Figure 5-3 Playback Interface.....23
- Figure 5-4 Credentials.....24
- Figure 5-5 Search .....24
- Figure 5-6 Search and Playback .....25
- Figure 5-7 Timeline Bar .....25
- Figure 5-8 Backup Clips .....27
- Figure 5-9 Backup Video .....28
- Figure 6-1 Management .....30
- Figure 6-2 Set New Password .....30
- Figure 6-3 Adding a Camera.....31
- Figure 6-4 Add A Camera by RTSP .....32
- Figure 6-5 Removing a Camera .....33
- Figure 6-6 Confirm Message .....33
- Figure 6-7 Camera Network.....34
- Figure 6-8 Edit Camera Position.....35
- Figure 6-9 Media-Stream Management-Live .....35
- Figure 6-10 Media-Stream Management-Recording .....36
- Figure 6-11 Media-Video.....37

Figure 6-12 Audio .....	38
Figure 6-13 Recording Options .....	39
Figure 6-14 Schedule .....	40
Figure 6-15 Image-Display.....	41
Figure 6-16 Image-Adjustment .....	42
Figure 6-17 Motion Detection .....	43
Figure 6-18 Event.....	44
Figure 6-19 Create a New Event-Status .....	44
Figure 6-20 Create a New Event-Trigger .....	45
Figure 6-21 Create a New Event-Action .....	45
Figure 6-22 Email Setup .....	46
Figure 6-23 Buzzer Setup.....	46
Figure 6-24 FTP Setup .....	47
Figure 6-25 Camera Alarm Out Setup.....	48
Figure 6-26 Pan-tilt-zoom setup.....	48
Figure 6-27 HTTP Setup .....	49
Figure 6-28 System Alarm Out.....	49
Figure 6-29 Event Schedule.....	50
Figure 6-30 System-Information.....	51
Figure 6-31 Maintenance .....	52
Figure 6-32 Reboot .....	53
Figure 6-33 Shutdown .....	53
Figure 6-34 Display .....	54
Figure 6-35 Layout.....	55
Figure 6-36 System Log-System .....	55
Figure 6-36 System Log- Recording .....	56
Figure 6-36 System Log- User.....	56
Figure 6-36 System Log- Error.....	56
Figure 6-37 User Page .....	57
Figure 6-38 Change Password .....	57
Figure 6-39 Reset Security Questions .....	58
Figure 6-40 Create a User.....	59
Figure 6-41 Login/Logout .....	60
Figure 6-42 Setting-Storage .....	60
Figure 6-43 Select Disk .....	61
Figure 6-44 Confirm.....	61
Figure 6-45 Creating Volume .....	61
Figure 6-46 Volume .....	62
Figure 6-47 IP .....	63
Figure 6-48 Service .....	64
Figure 6-49 P2P Setting .....	65
Figure 7-1 WAN/LAN Connection (HN300401xx) .....	74
Figure 7-2 (HN300802xx/HN301602xx) .....	74
Figure 7-3 Web Client Log in .....	75
Figure 7-4 Plugin Install.....	76
Figure 7-5 Live View Screen .....	76
Figure 7-6 Camera List .....	77
Figure 7-7 Layout.....	78

Figure 7-8 Live View Window .....	80
Figure 7-9 Information Bar .....	80
Figure 7-10 Tool Bar .....	80
Figure 7-11 PTZ Panel .....	81
Figure 7-12 Event Panel 2 .....	82
Figure 7-13 Event Clips.....	82
Figure 7-14 Search Recording Clips Screen.....	83
Figure 7-15 Calendar .....	84
Figure 7-16 Layout.....	84
Figure 7-17 Playback Panel.....	85
Figure 7-18 Event Panel .....	86
Figure 7-19 Event Filter .....	86

# Tables

Table 1-1 NVR Front Panel Description.....	3
Table 1-2 NVR Back Panel Description.....	4
Table 3-1 Main Toolbar.....	15
Table 3-2 Camera Toolbar.....	16
Table 3-3 PTZ Controls.....	18
Table 5-1 Timeline Bar.....	25
Table 6-1 Connection Type and Port.....	32
Table 6-3 Video Quality.....	37
Table 6-4 Compatible USB Table.....	53
Table 7-1 Web Live View Screen.....	76
Table 7-2 Layout Contents.....	79
Table 7-3 Information Bar.....	80
Table 7-4 Tool Bar.....	80
Table 7-5 Search Recording Clips Screen.....	83
Table 7-6 Layout.....	84
Table 7-7 Playback Panel.....	85

# About This Document

This document introduces the Honeywell 30 Series Network Video Recorder. It explains how to operate the Network Video Recorder.

This document is intended for installers and users.

## Overview of Contents

This document contains the following chapters:

- [Chapter 1, Introduction](#), describes the features, front and rear panel layout of the NVR.
- [Chapter 2, Getting Started](#), describes how to connect the NVR and log on to its user interface.
- [Chapter 3, Viewing Live Video](#), describes the NVR's real-time monitoring mode and associated NVR operations, including controlling a PTZ camera (if connected).
- [Chapter 4, Recording Video](#), describes how to manually record a video clip and how to set up automatic recording.
- [Chapter 5, Playing Back and Search Videos](#), describes how to search for and play back recorded video, and how to save recorded files to an external storage device.
- [Chapter 6, Settings](#), describes how to configure NVR settings.
- [Chapter 7, Management over a Web Console](#), describes how to operate the NVR's through web client.

## Special Fonts and Symbols

---

<i>Italic</i>	Indicates referenced chapter, figure number, page number, etc. In the electronic version, click on italicized text to switch to the corresponding page.
<b>Bold</b>	Indicates a button, or menu item.
<b>Note</b>	Alerts the user to the presence of important operating and maintenance (servicing) instructions in the literature accompanying the product.

---

## How to Use This Document

- Pictures in this manual are for reference only, please see the actual items for details.



- This product is subject to updates or changes without prior notice.
- Please familiarize yourself with this manual before operation and ensure its accessibility for future use.
- The manual has been reviewed and its accuracy is guaranteed. If there is any uncertainty or controversy, please refer to the final explanation of Honeywell. Honeywell does not take any responsibility for any consequences caused by the misunderstanding of the manual or incorrect operations by the user.

# 1 Introduction

This chapter contains the following sections:

- [Overview of the Network Video Recorder](#) on page 1.
- [Features of the Network Video Recorder](#) on page 1.
- [Network Video Recorder Components](#) on page 2.

## Overview of the Network Video Recorder

The 30 Series Network Video Recorder is a high-performance network video recorder. It supports:

- Local Live View
- Multiple-window display
- Local recorded file storage
- Mouse shortcut menu operation

The 30 Series Network Video Recorder also features multiple storage options:

- USB storage
- Front-end storage: The NVR's HDD storage

Because of the flexibility of its design, the 30 Series Network Video Recorder can be used in a variety of applications, such as public security, water conservancy, transportation, and education.

## Features of the Network Video Recorder

### User Management

- Different user rights for each group; each user belongs to a specific group.
- User rights cannot exceed Group rights.

### Storage

- Supports central server backup that follows your configuration and setup in Alarm or Schedule settings.
- Supports recording through the Internet. The recorded files are stored on the client's PC.

### Alarm

- Responds to external alarms almost instantly, based on your pre-defined relay setup. You can also configure a buzzer prompt upon alarm detection.

### Network Monitor

- The NVR supports the transmission of audio/video data that is compressed by an IP camera, which is then decoded for display. The delay time is more than 500 ms (sufficient network bandwidth support is required).
- Compatible to broadcast audio/video with the following transmission protocols: HTTP, HTTPS, TCP, RTP/RTCP.
- Transmits some alarm data or alarm information through SMTP.
- Supports Internet access through the WAN.

### Window Split

Video compression plus a digital process allows the NVR to split the monitor screen to show up to 4 video channels (HN300401xx)/8 video channels (HN300802xx)/16 video channels (HN301602xx) at the same time.

### Recording

Supports a schedule for recording. The recorded files can be saved in the HDD. You can search and view the recorded video that is stored locally or through the Internet connection.

### Backup

Supports backing up video to a USB device on local side or to PC client on web side.

### Network Management

- Supports NVR configuration and management through the Internet.
- Supports device management through the Internet.

### Auxiliary

- Supports viewing real-time system resources information and running statistics display.
- Supports log file.
- Supports local GUI output and shortcut menu operation with a computer mouse and keyboard.
- Supports setting up the configuration of a camera.

## Network Video Recorder Components

Figure 1-1 NVR Front Panel (HN300401xx)

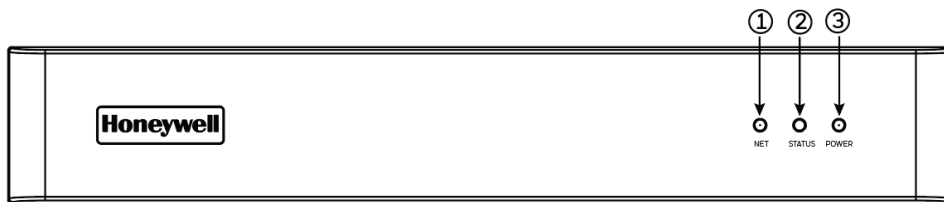


Figure 1-2 NVR Front Panel (HN300802xx/HN301602xx)

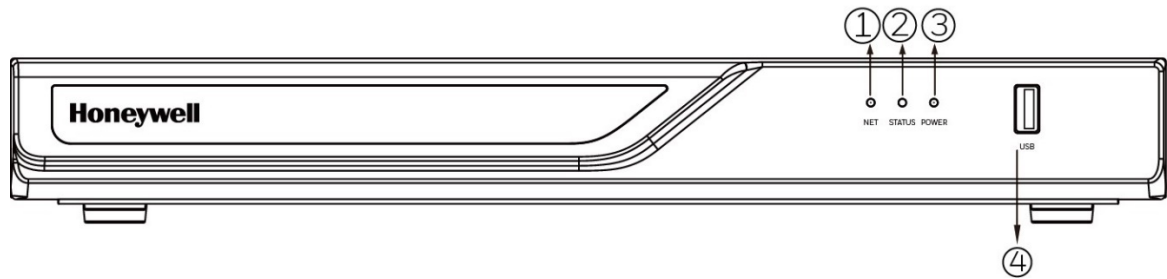


Table 1-1 NVR Front Panel Description

Name	Behavior	Definitions
1. Network uplink status/activity LED	Blinking Green	Data is being transmitted or received.
	OFF	The Ethernet uplink is disconnected.
2. System status LED	Constant Green	System ready.
	Blinking Green every 1 second	Updating firmware or device pack.
	Constant Red	<ol style="list-style-type: none"> <li>S.M.A.R.T.-related disk errors.</li> <li>A configured HDD is missing.</li> <li>HDD is full. Buzzer will also be sounded. When buzzer is turned off, LED will return normal.</li> </ol>
3. Power status LED	Solid Green	The NVR is powered on.
	OFF	The NVR is powered off.
4. USB port (HN300802xx/HN301602xx)		

Figure 1-3 NVR Back Panel (HN300401xx)

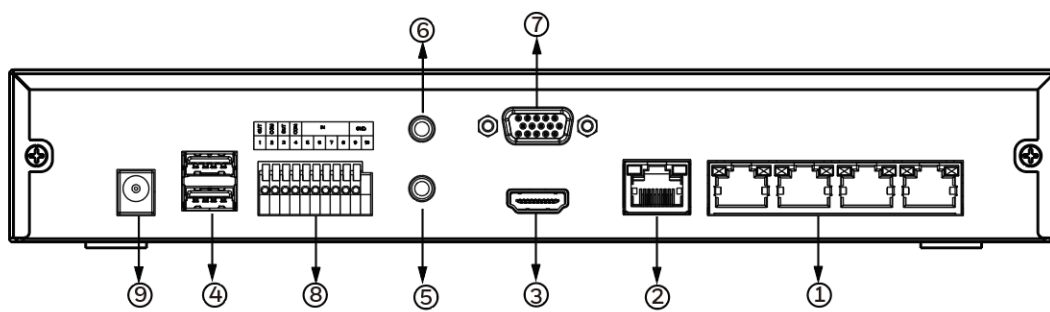


Figure 1-4 NVR Back Panel (HN300802xx/HN301602xx)

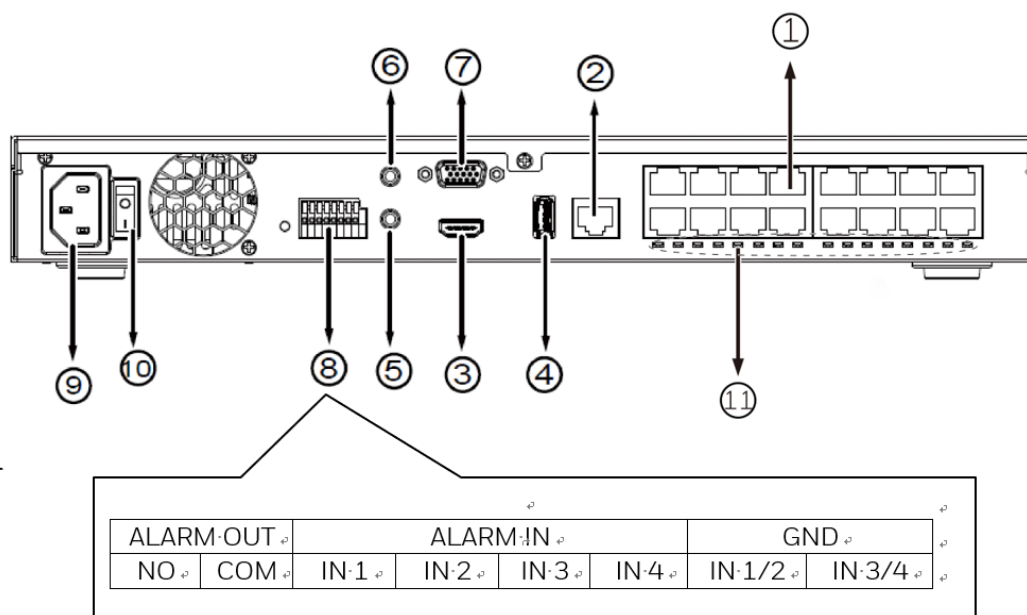


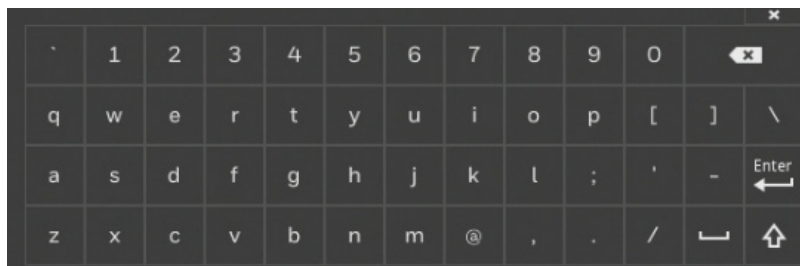






Table 1-2 NVR Back Panel Description

1	HN300401xx: PoE ports # 1 to #4 for connecting to cameras directly. HN300802xx: PoE ports # 1 to #8 for connecting to cameras directly. HN301602xx: PoE ports # 1 to #16 for connecting to cameras directly.	7	VGA
2	RJ45 port - GbE uplink	8	Alarm In/Alarm Out terminal block
3	HDMI	9	Power socket (110/240V AC) (HN300802xx/HN301602xx)
4	USB port	10	Power Switch (HN300802xx/HN301602xx)
5	Audio IN (Reserved)	11	Channel LED: 1 to 8 / 16 (from left to right) (HN300802xx/HN301602xx)
6	Audio OUT		

## Using the On-screen Keyboard

- To display the on-screen keyboard, click  on the main toolbar (see [Figure 3-3 Main Toolbar](#)) in live view screen to go to the settings screen.
- Click  on the menu to expand the on-screen keyboard.

**Figure 1-5 On-screen Keyboard**

- To switch between lowercase and uppercase letters, click .
  - To delete the previous character, click .
  - To insert a space, click .
3. Click **Enter** or  to close the on-screen keyboard.

# 2 Getting Started

This chapter contains the following sections:

- [Connecting External Devices](#) on page 6.
- [Starting and Shutting Down the NVR](#) on page 8.
- [Device Initialization](#) on page 9.

## Connecting External Devices

- **Connect the cameras**

Connect the RJ45 network cables from the cameras to PoE ports.

- **Connect the monitor**

Connect a VGA cable (not supplied) to the VGA interface and/or an HDMI cable (not supplied) to the HDMI interface. Connect the other end to a monitor (do not use a TV). Simultaneous VGA and HDMI output is supported.

- **Connect the mouse**

Connect the supplied USB mouse to the USB port.

- **Connect the Ethernet cable**

Connect the supplied CAT5e Ethernet cable to the network port. Connect the other end to a router on your network.

- **Connect audio devices (if applicable)**

To play audio, connect an audio output device (low-impedance headphones, speaker, or amplifier) to the AUDIO OUT connector (200 mV / 1 kilohm).

- **Connect alarm devices (if applicable)**

Connect alarm devices to the alarm in/out interface. If the alarm inputs use external power, the device must have the same ground as the NVR.

- **Connect a PTZ camera (if applicable)**

Your embedded NVR communicates with PTZ cameras through the Network. Ensure that your camera is correctly connected to the Network.

- **Connect the power cable**

Use only with the supplied power cable. Power output: 50W for 4 channels /120W for 8 channels / 200W for 16 channels. PoE 802.3at in total. Use of an uninterruptible power supply (UPS) is strongly recommended.

## Devices Connection

The following diagram shows a typical NVR connection:

---

**Note** There's no device connection on the front panel for 4 video channels (HN300401xx).

---

Figure 2-1 Devices Connection (HN300401xx)

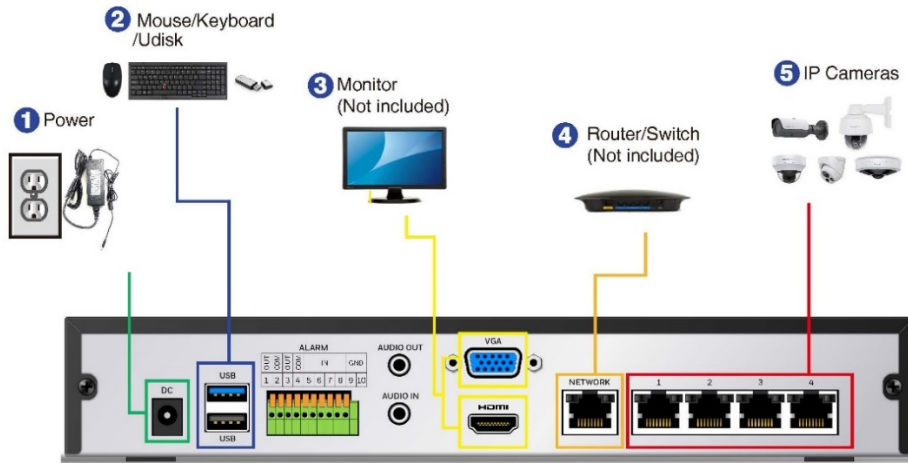
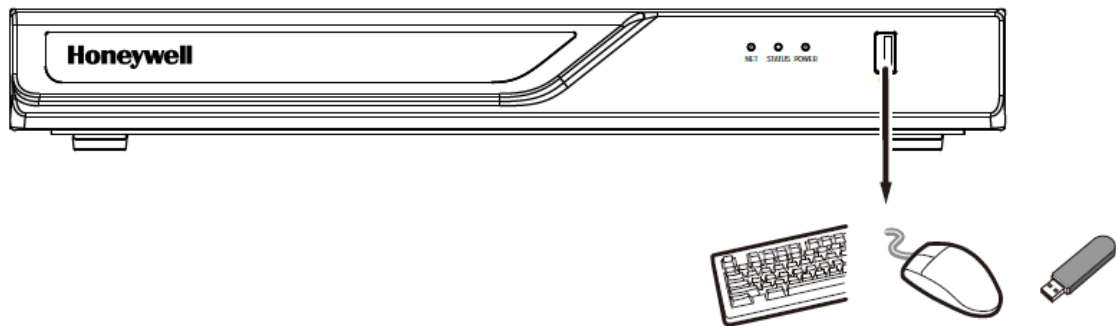
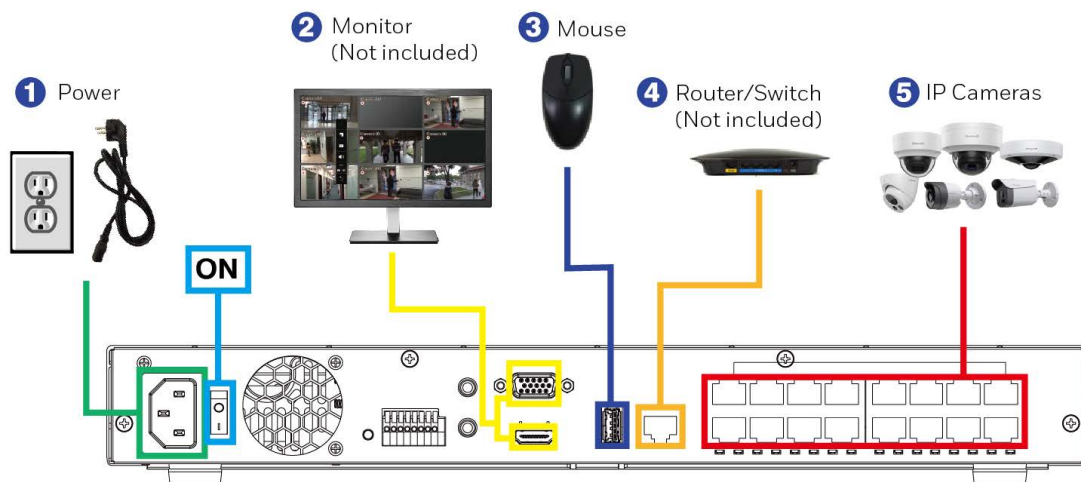


Figure 2-2 Devices Connection (HN300802xx/HN301602xx)







## Starting and Shutting Down the NVR

### Starting the NVR

1. Verify that the NVR is connected to an appropriate power source.
2. For 8/16 video channels (HN300802xx/HN301602xx), turn on the power switch (See No. 10 in [Figure 1-4](#)) on the back panel to start the NVR. There's no power switch on the back panel for 4 video channels(HN300401xx).

### Shutting Down/Reboot the NVR

To prevent damage to the hard drive, follow these steps to shut down the NVR:


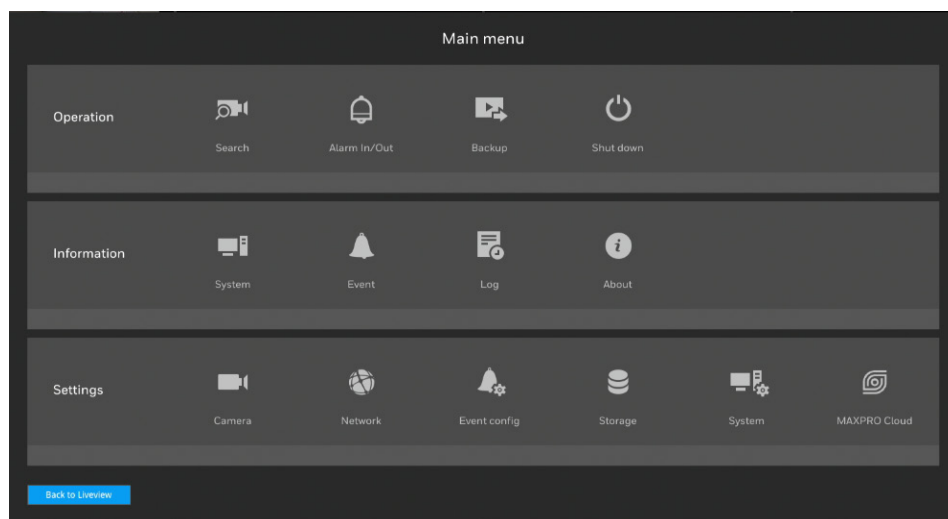
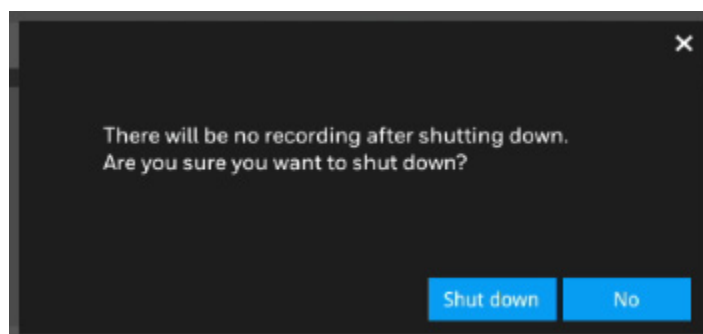
1. In live view screen, click  (**Main Menu**) on the main toolbar (see [Figure 3-3 Main Toolbar](#)).

Figure 2-3 Main Menu



2. In the **Main Menu** window, click  **Shut down**.

Figure 2-4 Shutdown

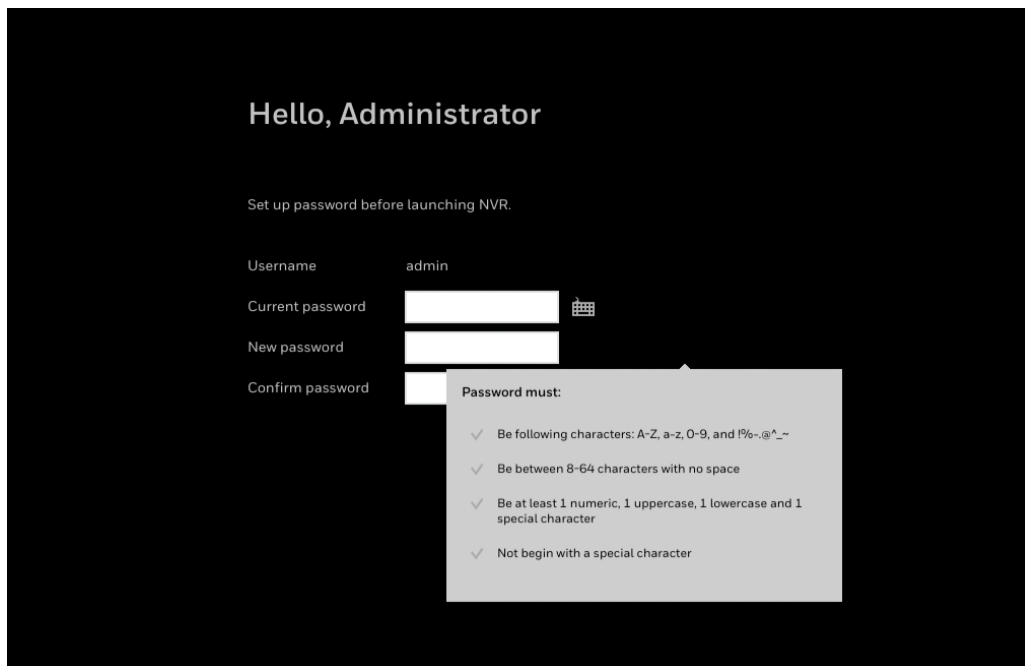


3. Click **Shut down** button.



## Device Initialization

When the NVR has booted up, set password before launching NVR.

**Figure 2-5 Device Initialization –Password Setup**

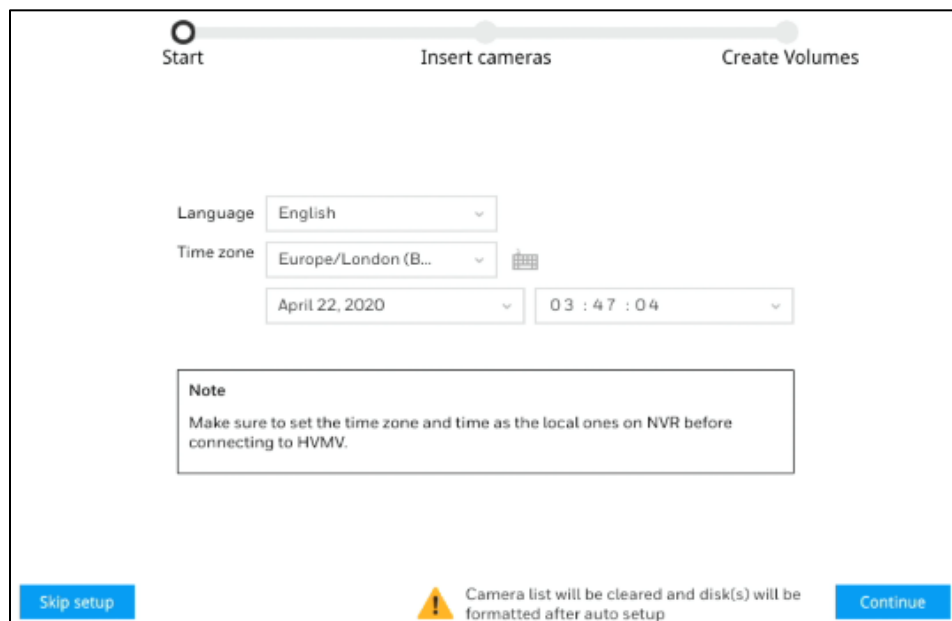


1. Enter the current password “1234” and set the new password according to the password requirements. The default username is **admin**.

You can use the USB mouse to input the password. Click  to expand the on-screen keyboard to switch the input mode between numbers and English letters; click  to change between lowercase and uppercase.

2. When the password setup is completed, click **Apply** and the following window is displayed:

**Figure 2-6 Device Initialization–Language and Time Zone**



Select the language and time zone from the dropdown list and set date and time.

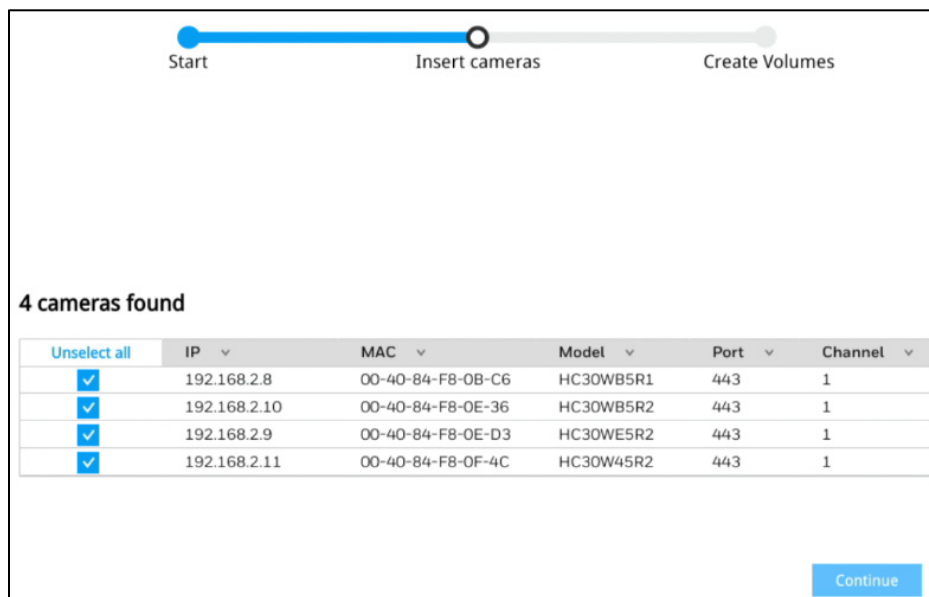
---

**Note**

- See [Creating a Volume](#) on [page 60](#) to manually create the volume if you click **Skip setup** to skip this auto setup.
  - After the hardware is reset, skipping setup is required to ensure the hard disk is not formatted.
- 

3. Click **Continue** and cameras that have been searched within the LAN will be listed:

**Figure 2-7 Device Initialization-Search for Cameras**

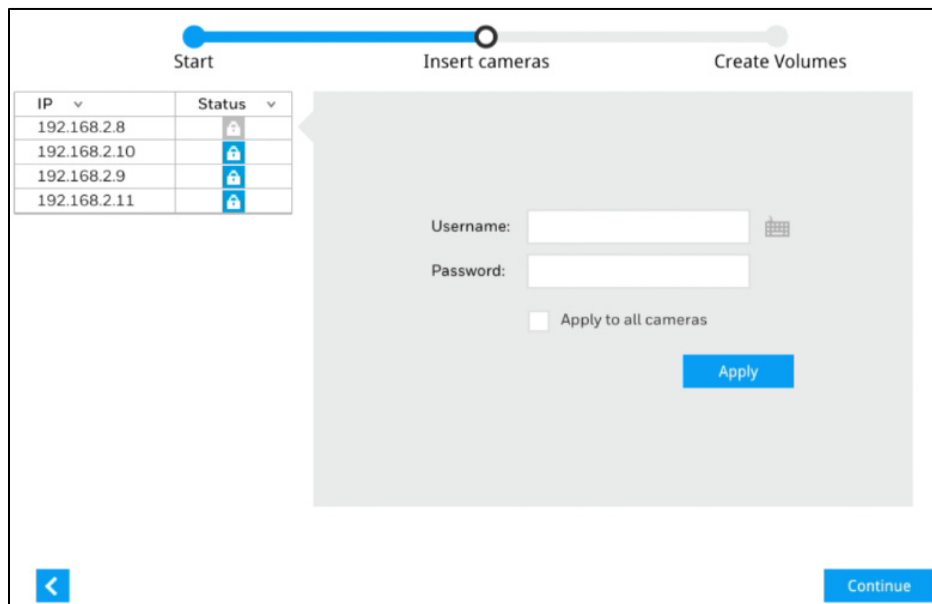


**Note**

- This step will not be stayed for long if the cameras are accessed by default password.
  - 30 series Camera FW version is V19.12.13 or later.
- 

4. Click **Continue** and the following windows is displayed:

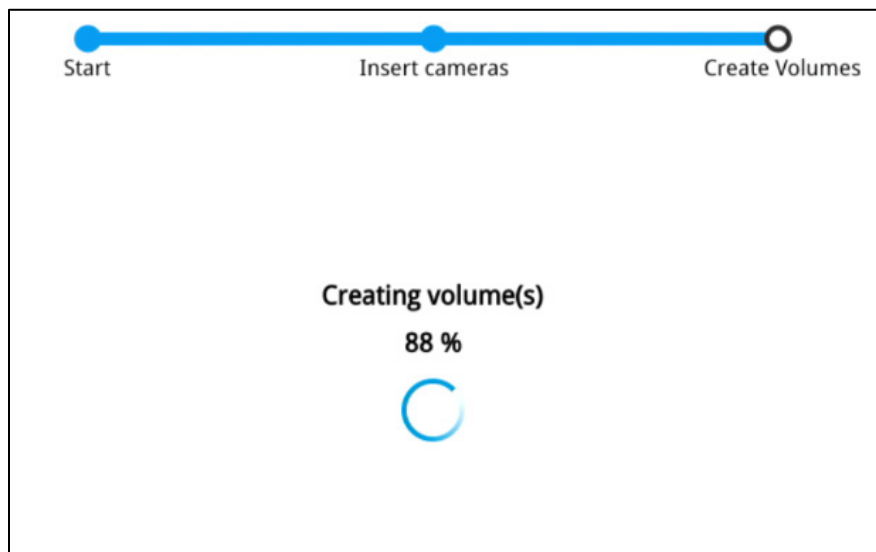
Figure 2-8 Device Initialization-Insert Cameras



Enter the username and password of the camera.

5. Click **Continue** and the following window is displayed:

Figure 2-9 Device Initialization-Creating Disks



When the initialization is completed, the live view screen is displayed:

Figure 2-10 Live View Screen



# 3 Viewing Live Video

This chapter contains the following sections:

- [About Live View](#) on page 14.
- [Live View Window](#) on page 15.
- [Toolbars](#) on page 15.
- [Shortcut Menu](#) on page 17.
- [Working with the PTZ Control Panel](#) on page 18.
- [Configuring PTZ Settings](#) on page 19.

## About Live View


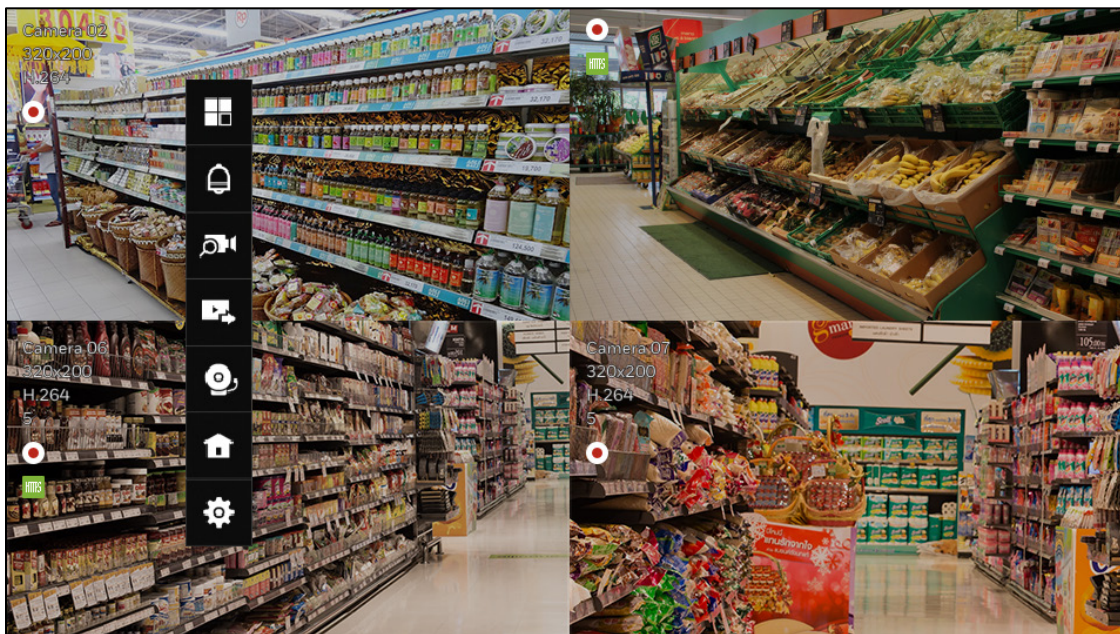
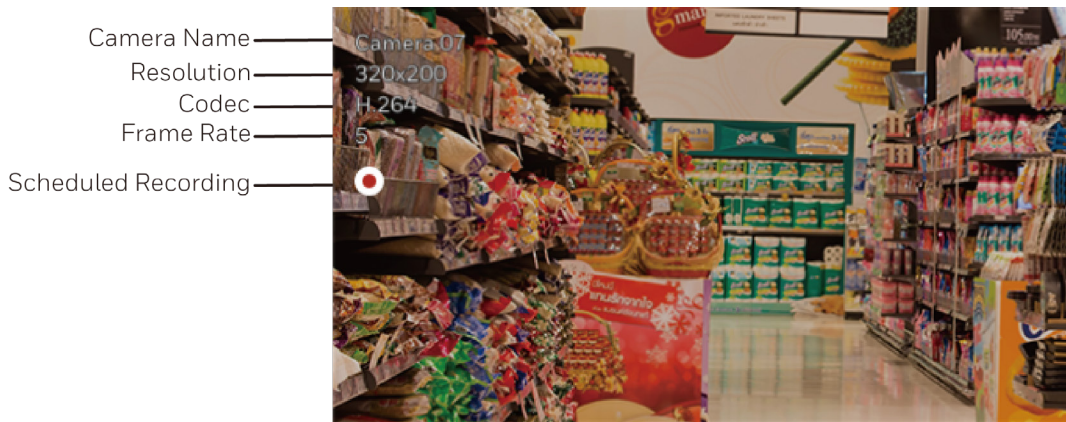
Live view screen is the NVR's default screen. When the NVR is started, live video from the connected cameras is displayed on the screen. Change the window layout via  on the main toolbar.

Figure 3-1 Live View Screen



## Live View Window

Figure 3-2



## Toolbars

There are two toolbars (the main toolbar and the camera toolbar) that appear in front of the live view screen. Make sure a mouse is attached to your NVR. Move your mouse cursor on live view screen, and the Main Toolbar will appear. Click to select a view window, the Camera Toolbar will appear. Toolbars can be dragged to desirable place using mouse.

To hide the toolbar, right click the mouse on the window and deselect “Show toolbar”.

Figure 3-3 Main Toolbar

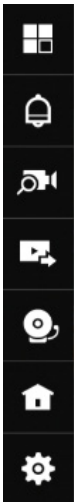



Table 3-1 Main Toolbar

Icon	Name	Function
	Layout	Select screen layout format and rotation.









	<b>Alarm In/ Out</b>	Set the Alarm in /out.
	<b>Search</b>	Search for the recording clips.
	<b>Backup</b>	Export recordings.
	<b>Stop buzzer</b>	Stop buzzer.
	<b>Main Menu</b>	Open the main menu window.
	<b>Settings</b>	Open the settings interface.

Figure 3-4 Camera Toolbar

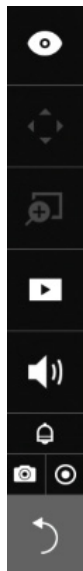











Table 3-2 Camera Toolbar

Icon	Name	Function
	<b>Fisheye</b>	Expand the fisheye display mode.
	<b>PTZ</b>	Expand the PTZ control panel. It is only activated with a camera that supports mechanical PTZ.
	<b>Digital zoom</b>	This applies when a camera is displaying the full of its field of view. Click it to zoom in on the field of view.
	<b>Play recording clip</b>	Search for the recording clips.

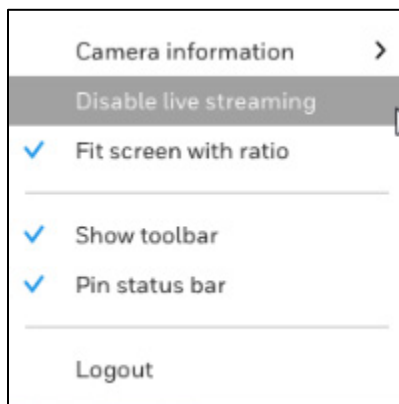
	<b>Audio</b>	Adjust the volume or mute the audio.
	<b>Alarm In/ Out</b>	Set the Alarm in /out.
	<b>Snapshot</b>	Click to take a snapshot from the camera currently selected. <b>Note:</b> this function only saves the snapshot (in JPEG) to a USB thumb drive.
	<b>Manual recording</b>	Click to start a manual recording from a selected camera. Click again to stop the recording.
	<b>Deselect camera</b>	Click to return to the Live View window.

- Note**
- **Live view:** if no management activities occur for a period, the tool bars disappear from screen. When in the idle mode, mouse cursor and tool bars will disappear. Moving the mouse cursor will re-activate the screen.
  - **Settings page:** If left unattended for a period, system will automatically log out. The system will prompt for user credentials if a user tries to access the Settings page again.
  - **Search recording clips window:** If currently there is a video playback, the system will not enter the idle mode.

## Shortcut Menu

The shortcut menu is displayed by right-clicking on the selected window.

Figure 3-5 Shortcut Menu



## Working with the PTZ Control Panel (If Applicable)

You can control a PTZ camera connected to the NVR through a network connection using the on-screen PTZ control panel on the camera tool bar.

### PTZ Control Panel

Figure 3-6 PTZ Control Panel

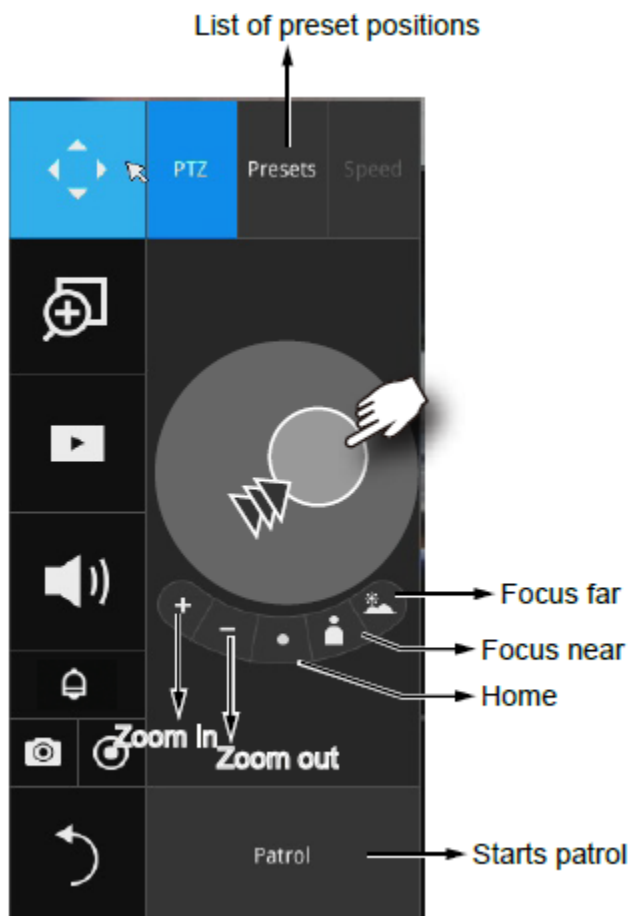


Table 3-3 PTZ Controls

Name	Function
PTZ control	Click and drag the circle in the center towards the direction you wish to move to.
Focus	Click the Focus near and Focus far buttons to adjust camera focus.
Home	Click to move the camera lens towards the default home position.
Zoom	Use the Zoom in and Zoom out buttons to adjust the camera's zoom ratio.

<b>Preset</b>	If you configured preset positions, click this button, a list of preset positions will appear.
<b>Patrol</b>	If you configured preset positions into a patrolling tour, click this button and the camera will proceed with patrolling through preset points.

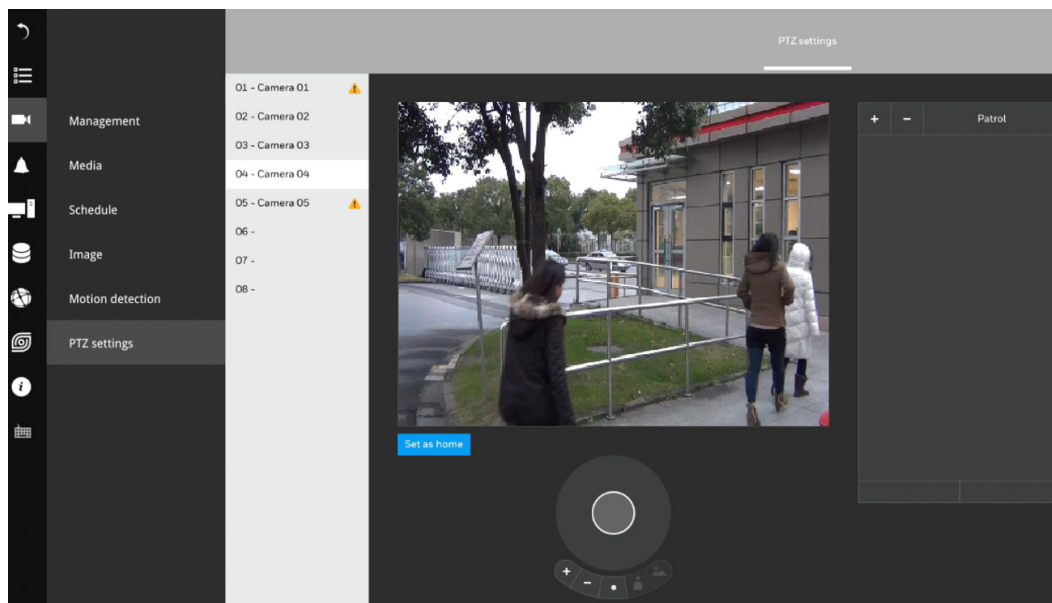
## Configuring PTZ Settings


You can configure presets, tours, patterns, and borders using the PTZ control panel.

### Configuring PTZ Presets

Go to  →  → PTZ settings:

Figure 3-7 PTZ Settings



- Select a PTZ camera.
- Use the PTZ panel to move to a field of view where you want to designate as a preset position.
- Click , and enter a name for the position. Press Enter to proceed.
- Repeat the configuration to create more positions.
- Click **Apply** for the configuration to take effect.

---

**Note** The PTZ panel can vary with different PTZ cameras.




---

# 4 Recording Video


This chapter contains the following sections:

- [Manual Recording](#) on page 20.
- [Scheduled Recording](#) on page 20.

## Manual Recording

In live view window, select a window and click  on the camera tool bar to start a manual recording. The manual recording icon  will appear on the window. Click  again to stop the manual recording.

## Scheduled Recording

By default, all video feeds from cameras are recorded at all time with the icon  appeared on the window. You can modify the recording task using the schedule tool:



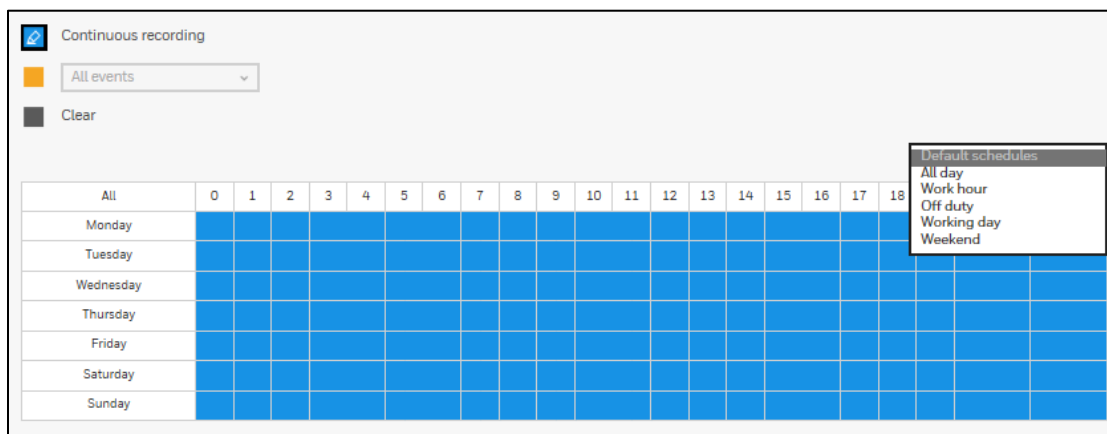
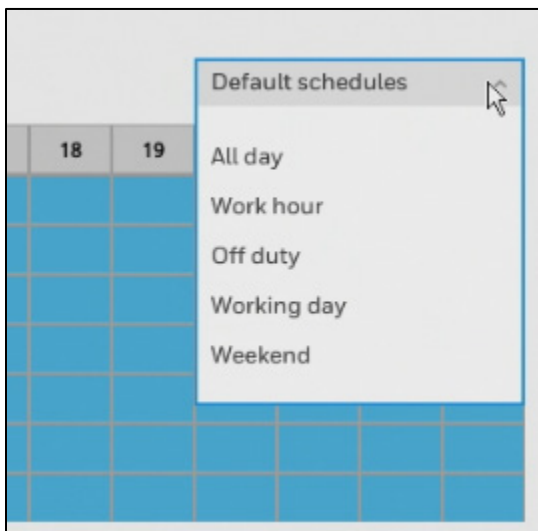
Go to  →  → Schedule → Schedule.

Figure 4-1 Scheduled Recording



1. Select a camera and click to select a recording condition's checkbox—**Continuous recording**, **Event recording** and **Clear** (no recording).
2. Click and drag on the cells on the time table. For example, to stop the recording during a period, select the **Clear** checkbox and move the cursor across the time table. The minimum unit on the table is half an hour.
3. You may also use the scheduler tool on the right to facilitate the process.

Figure 4-2 Scheduled Recording



- a) Select a condition checkbox, and then select the **All day**, **Work hour**, **Off duty**, **Working day**, **Weekend** options to apply a time selection.

---

**Note** Make sure to deselect the “All day” option before selecting the “Work hour”, “Off duty”, “Working day” and “Weekend” options.

---

- b) Repeat the process on individual cameras or click **Apply to all cameras** at the right bottom if the schedule can apply to all cameras.
4. When the configuration is completed, click **Apply**.

# 5 Playing Back and Search Videos

This chapter contains the following sections:

- [Playing Recording Clips](#) on page 22.
- [Searching Videos](#) on page 23.
- [Timeline Bar](#) on page 25.
- [Backing Up Video](#) on page 27.

## Playing Recording Clips

The Play Recording Clips function provides a shortcut to the latest recordings on the system. You can select 30 secs, 1 min, 3 mins, 10 mins, and 60 mins for an immediate playback.


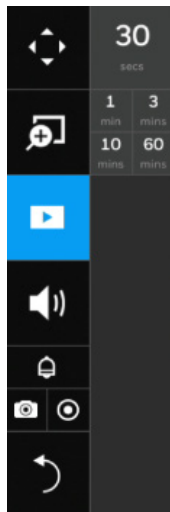
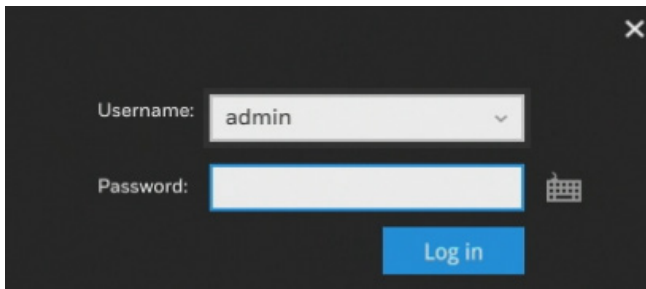
1. Select a camera and click  on the camera toolbar and select a period you want to playback for.

Figure 5-1 Camera Toolbar-Playing Recording Clips



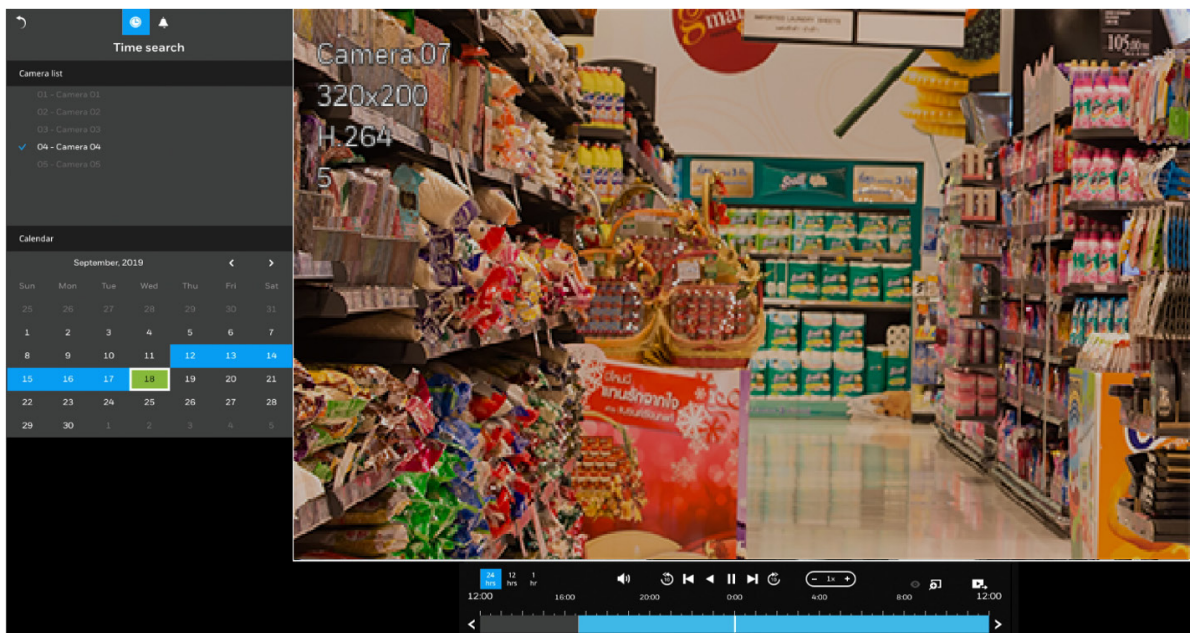
2. A confirm window is displayed: (If left unattended for a period, system will automatically log out)

Figure 5-2 Credentials




3. Enter the username and password. Click **Log in** and the playback interface is displayed:

Figure 5-3 Playback Interface



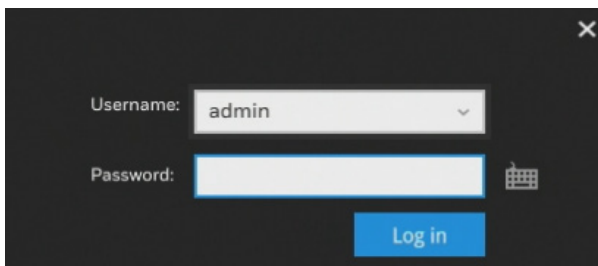
The playback begins from the point in time you selected, e.g., 30 seconds ago. This function allows you to quickly review what has just happened.

## Searching Videos

1. Click  on the main toolbar and a confirm window is displayed: (If left unattended for a period, system will automatically log out)

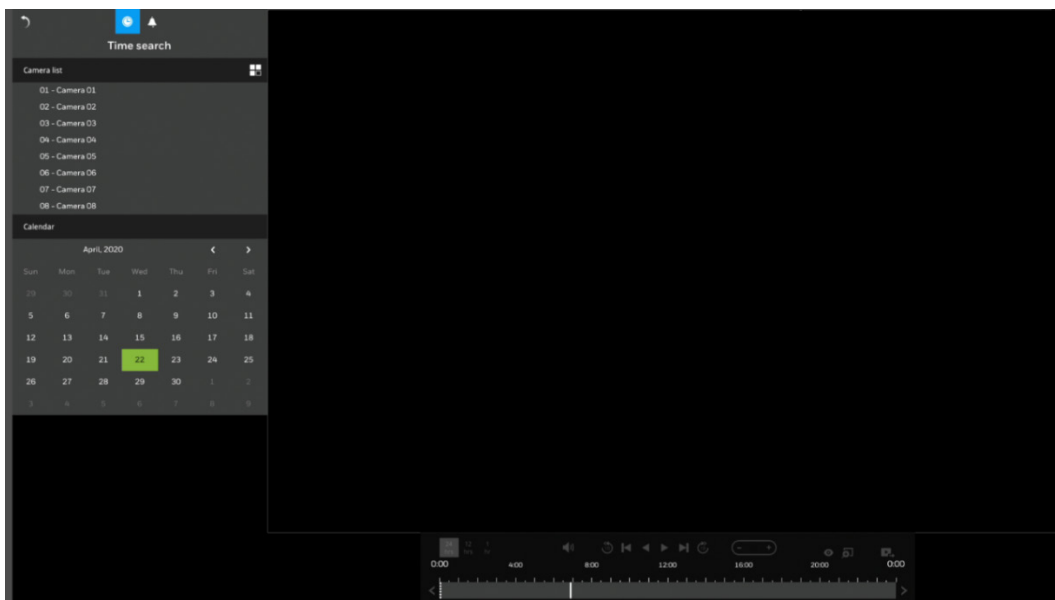


**Figure 5-4 Credentials**



2. Enter the username and password. Click **Log in** and the search interface is displayed:

**Figure 5-5 Search**




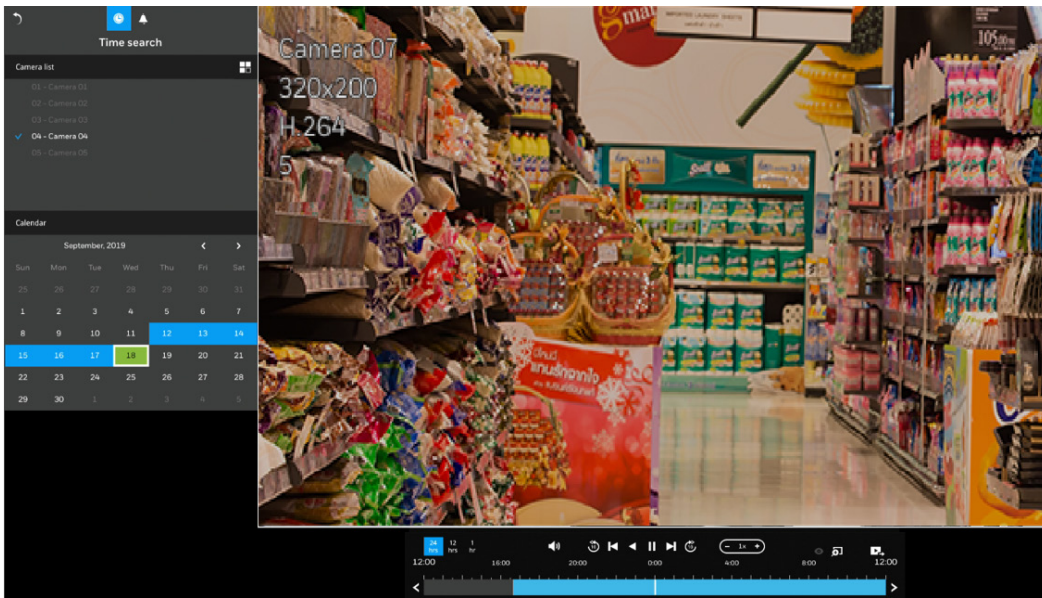
3. Select cameras (up to 4 cameras) in the camera list and the days with recorded clips will be highlighted in blue. The date highlighted in green indicates today.
4. Click  to set up the layout when several cameras are played back simultaneously.
5. Double-click on a day to begin playback and search.

Figure 5-6 Search and Playback



6. Click the camera again to deselect it and select another one to playback if needed.

**Note**

- If a camera is deleted from the NVR, the recorded videos cannot be searched until it is added to the NVR.
- In case of four cameras playback simultaneously, the maximum resolution of each camera is 1080P.

## Timeline Bar

By default, the playback starts from the beginning of a day's recording. While playing the recorded video, click on the timeline to replay a point in time in the video.

Figure 5-7 Timeline Bar

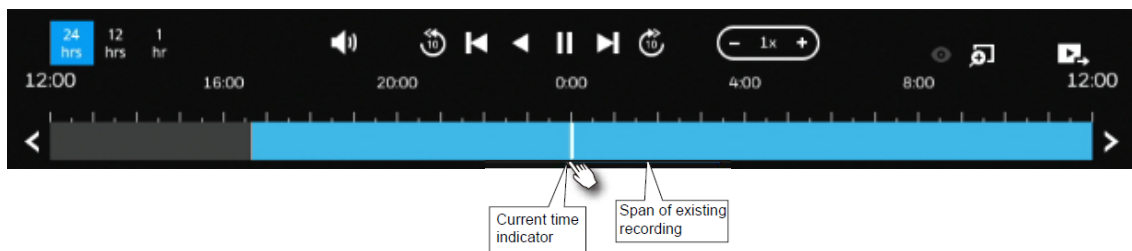




















Table 5-1 Timeline Bar

Buttons	Description
	Time scale selector
	Use the buttons to select the span of time displayed on the tool bar.

	Audio volume tuner
	Play back from 10 seconds ago. (Suggest disabling the Dynamic Intra Frame period (DIF) setting (  →  → <b>Media</b> → <b>Video</b> ) when perform this function as the time interval may not be 10 seconds while Dynamic Intra Frame period (DIF) is enabled.)
	Play back from 10 seconds after. (Suggest disabling the Dynamic Intra Frame period (DIF) setting (  →  → <b>Media</b> → <b>Video</b> ) when perform this function as the time interval may not be 10 seconds while Dynamic Intra Frame period (DIF) is enabled.)
	Previous frame (I-frame only)
	Next frame (I-frame only) After you paused a playback, use this button to browse video frame by frame.
	Play backwards
	Play This button is available after you paused a playback.
	Pause
	Each click on it speeds down by 1/2. The slowest speed is 1/16.
	Each click on it speeds up by 2x. The fastest speed is 16 times. The current playback status is indicated on the screen.
	Fisheye display mode
	Digital zoom This applies when a camera is displaying the full of its field of view. You can use the Digital zoom function to zoom in on the field of view.
	Export clips Use this function to select a span of time you want to export to other medias.

## Backing Up Video



### To Back Up Using the Playback Timeline Bar

Maximum 10 minutes of clips length for export via this method.

1. Insert a USB storage device (such as a USB flash drive) into one of the USB ports on the NVR.

Figure 5-8 Backup Clips



2. Click  on timeline bar.
3. Select the "From time" by clicking on the timeline. You can also manually enter the "From time" and the "To time."
4. Click the "From time" tab using a single click.
5. Repeat steps 3 and 4 to configure the "To time".
6. Click .

### To Back Up Using the Main Tool Bar

The Export recordings button allows users to directly select a piece of recordings by a specific camera, and export that to a USB thumb drive. Users can select one or multiple cameras, select a period in which the recording took place, and then click **Export**.

The maximum length of recording export is 24 hours.


1. Insert a USB storage device (such as a USB flash drive) into one of the USB ports on the NVR.
2. Click  on main tool bar and the following window is displayed:

Figure 5-9 Backup Video

The screenshot displays a web interface titled "Backup". At the top left, there is a "Select cameras" label and a blue "Select all" button. Below this is a large grey rectangular area containing a blue button with a white camera icon, the number "1", and the text "Camera 01". Underneath the camera selection area is the "Select time" section. It includes a "From" label followed by two dropdown menus: the first shows "February 15, 2019" and the second shows "14 : 12". Below that is a "To" label followed by two more dropdown menus: the first shows "February 15, 2019" and the second shows "15 : 12". A note below the time selection reads "Maximum 24hrs of clip length for backup". At the bottom left is a blue "Back to Liveview" button, and at the bottom right is a blue "Backup" button.

3. Select one or multiple cameras from the camera list.
4. Select the start time of the period of recording time and the end time of the period of recording time.
5. Click **Backup**.

# 6 Settings

This chapter contains the following sections:

- [Setting-Camera-Management](#) on page 29.
- [Setting-Camera-Media](#) on page 35.
- [Setting-Camera-Schedule](#) on page 38
- [Setting-Camera-Image](#) on page 41.
- [Setting-Camera-Motion Detection](#) on page 42.
- [Setting-Camera-PTZ settings](#) on page 43.
- [Setting-Event-Event](#) on page 44.
- [Setting-Event-Email](#) on page 50.
- [Setting-System-Information](#) on page 50.
- [Setting-System-Maintenance](#) on page 52.
- [Setting-System-Display](#) on page 53.
- [Setting-System-Log](#) on page 55.
- [Setting-User](#) on page 56.
- [Setting-Login/Logout](#) on page 59.
- [Setting-Storage](#) on page 60.
- [Setting-Network](#) on page 63.
- [Setting-MAXPRO Cloud](#) on page 65.

## Setting-Camera-Management

### Change Password

Go to  →  → Management → Add/edit.

**Figure 6-1 Management**

The screenshot shows a web interface for managing cameras. At the top right, there are tabs for 'Add/edit', 'Network', and 'Camera position'. On the left, there is a sidebar with icons for a camera and a trash can, and a list of cameras from '01 - Camera 01' to '08 - Camera 08'. The main area displays configuration for 'Camera 01':

- Camera name: Camera 01
- Binding: MAC
- Connection type: HTTPS
- IP: 192.168.2.14
- Port: 443
- Protocol: Honeywell
- Camera channel: 1
- Model: HC30WB5R2
- MAC: 00-40-84-F8-0E-36

At the bottom, there is a section for 'Username' (admin) and 'Password' with two buttons: 'Input password' and 'Change password'.

1. Click **Change Password**.

**Figure 6-2 Set New Password**

The screenshot shows a 'Set New Password' dialog box with the following fields and options:

- New Password**: An empty text input field.
- Confirm Password**: An empty text input field.
- Password must:**
  - Be following characters: A-Z, a-z, 0-9, and !%-.@^\_~
  - Be between 8-64 characters with no space
  - Be at least 1 numeric, 1 uppercase, 1 lowercase and 1 special character
  - Not begin with a special character
- Apply New Password to all camera
- Apply NVR Password to all camera
- Apply** and **Cancel** buttons.

2. Input the new password and confirm it.
3. Click **Apply**.

**Note**

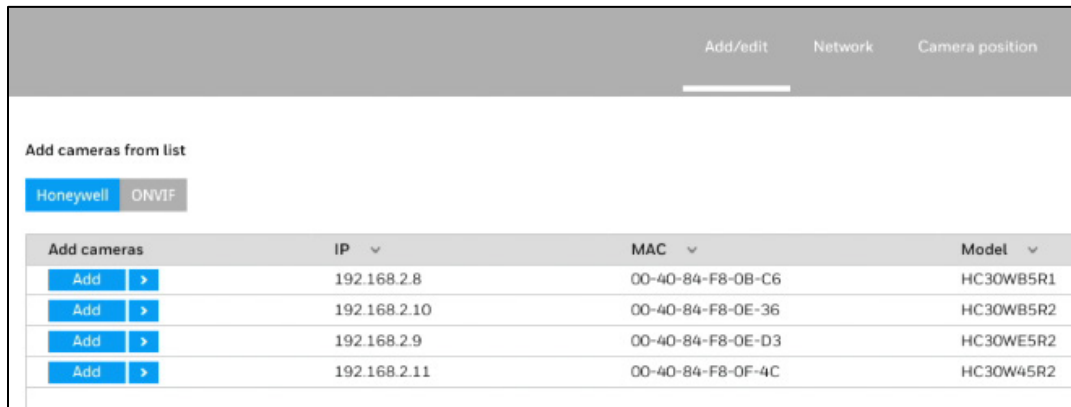
Camera's password can only be changed at local client for new password and NVR password setting to the cameras, not available at web client.

## Adding a Camera

Go to  →  → Management → Add/edit.

1. Click  and a list of cameras in the same subnet will appear:

Figure 6-3 Adding a Camera



2. Click **Honeywell** or **ONVIF** to select the camera protocol.

---

30/60 series cameras that support the Honeywell protocol:


HC30W42R3 HC30WE2R3 HC30WB2R1 HC30W45R3 HC30WE5R3 HC30WB5R1

**Note** HC30W45R2 HC30WB5R2 HC30WE5R2 HC30WF5R1 HC30W25R3  
 HC60W35R2 HC60W35R4 HC60W45R2 HC60W45R4 HC60WB5R2 HC60WB5R5  
 HC60WZ2E30 HC60W45R5 HC60W34R2 HC60W34R2L HC60W44R2 HC60W44R2L  
 HC60WB4R2 HC60WB4R2L HC60WZ5R30 HC60WZ2R36 HC60WZ5E30 HC60WZ5I30

---

3. Click **Add** and the camera will be placed at an unoccupied position. You may also expand the menu on the side of the **Add** button to select a position number.

When a camera is added, it should appear on the graphical placement below.

4. Click **Apply** after you added cameras.
5. You can click  to return to the previous window.

---

**Note** When a camera is connected to an NVR, the camera's system time will be modified the same as the NVR's system time without change for the time zone.

---

You can manually add a camera by using RTSP connection:



**Figure 6-4 Add A Camera by RTSP**

The screenshot shows a configuration form for adding a camera. The form is titled 'Add/Edit' and has a 'Network' tab selected. The fields are as follows:

- Camera name: Camera 01
- Binding: IP
- Connection type: HTTPS
- IP: 192.168.152.194
- Port: 443
- Protocol: RTSP
- URL: live.sdp

1. Select an empty camera entry.
2. Select Connection type and Port according to the below table:

**Table 6-1 Connection Type and Port**

Connection type	Port
HTTPS	443
HTTP	80
TCP	554

3. Enter IP address in the IP field.
4. Select **RTSP** in the **Protocol** field and enter "live.sdp" in the URL field.

The original RTSP address is: rtsp://<ip address>:<rtsp port>/<access name for stream 1 to 3>. For example, when the access name for stream 1 is set to live.sdp, the original RTSP is: rtsp://192.168.5.151:554/live.sdp.

The system automatically fills in the other parameters.

5. Click **Apply**.

**Note**

- RTSP cameras do not support event recording in the Schedule settings.
- RTSP cameras do not support FTP, Camera DO, and PTZ as the Alarm action.
- RTSP cameras do not support camera's related settings such as Network, Video, Audio, and Display configurations.
- RTSP cameras will be indicated by an RTSP tag in the device list.
- RTSP cameras do not support Motion detection configuration.

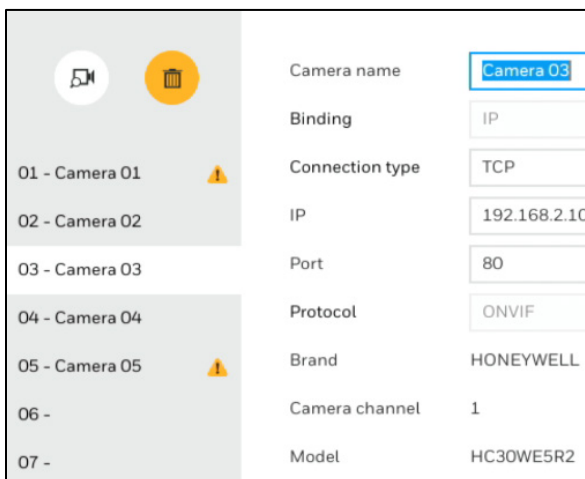
- RTSP cameras cannot be selected as an alarm trigger.
- In Media > Stream management page, the related Video, Audio, and stream configuration for RTSP cameras cannot be edited. The RSTP cameras will be tagged.

## Removing a Camera

Go to  →  → Management → Add/edit.

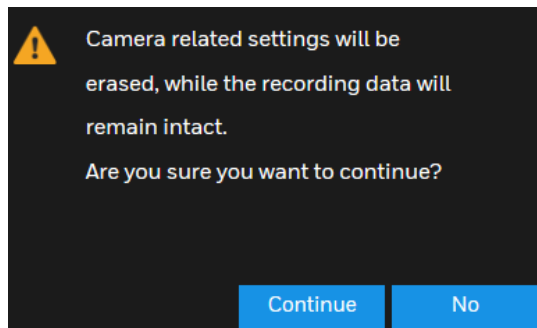
1. Click  and the remove button displays as .

Figure 6-5 Removing a Camera



2. Mouse over to the camera you want to remove, and its entry will display the Remove message.
3. Click the **Remove** message and a confirm window prompted:

Figure 6-6 Confirm Message



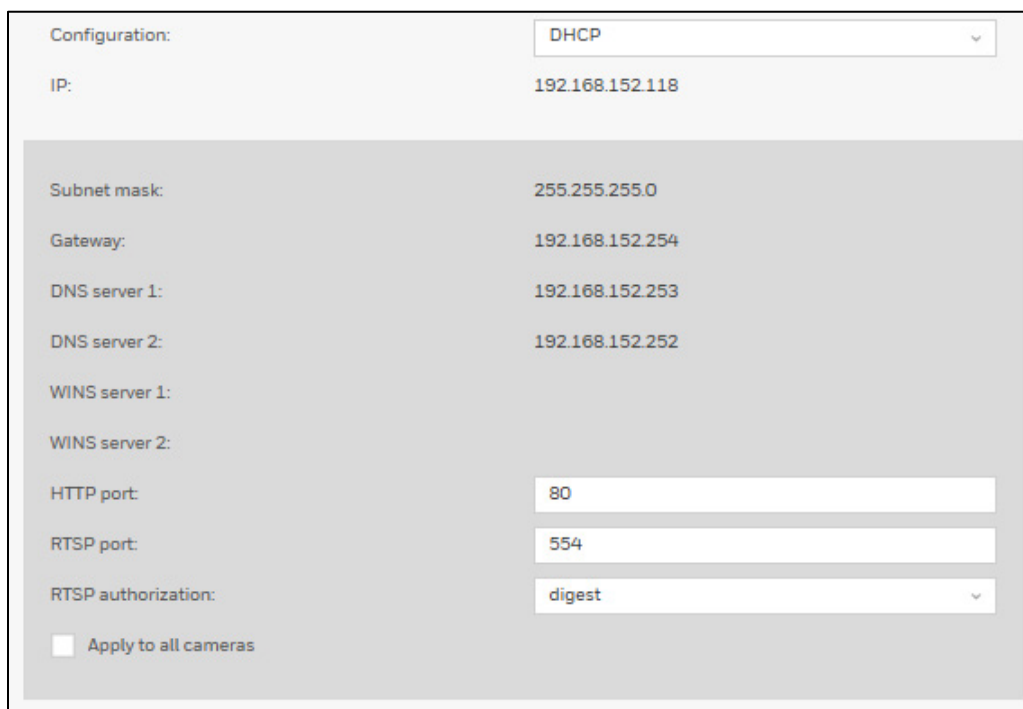
4. Click **Continue** to remove the camera.

## Network

Go to  →  → Management → Network.

Here you can configure the network type, IP address, and the connection ports for video streaming.

Figure 6-7 Camera Network



Configuration:	DHCP
IP:	192.168.152.118
Subnet mask:	255.255.255.0
Gateway:	192.168.152.254
DNS server 1:	192.168.152.253
DNS server 2:	192.168.152.252
WINS server 1:	
WINS server 2:	
HTTP port:	80
RTSP port:	554
RTSP authorization:	digest
<input type="checkbox"/> Apply to all cameras	

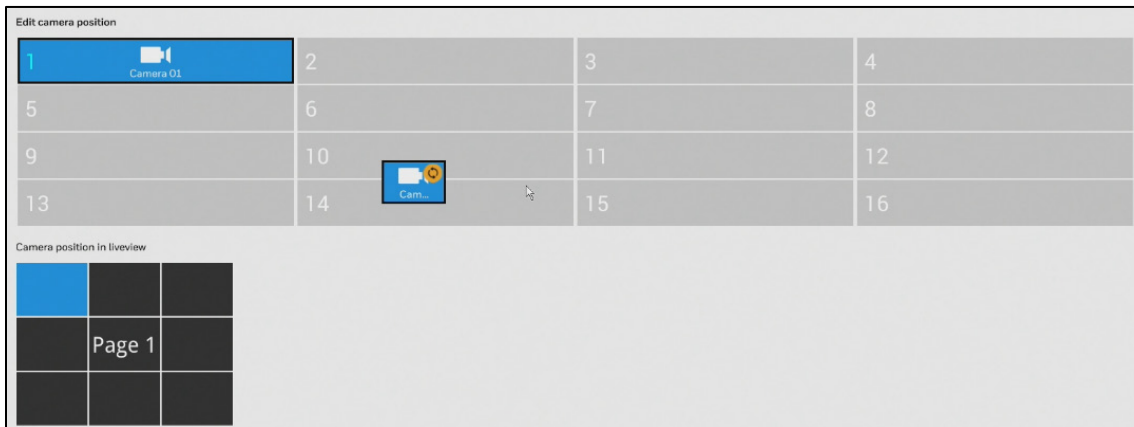
You can select DHCP as the method for cameras to acquire IP addresses, or you can manually configure static IPs for a single or all cameras.

It is usually not necessary to change port numbers for the HTTP and RTSP ports unless there is a conflict in your network environment.

## Camera Position

Go to  →  → Management → Camera position.

Figure 6-8 Edit Camera Position



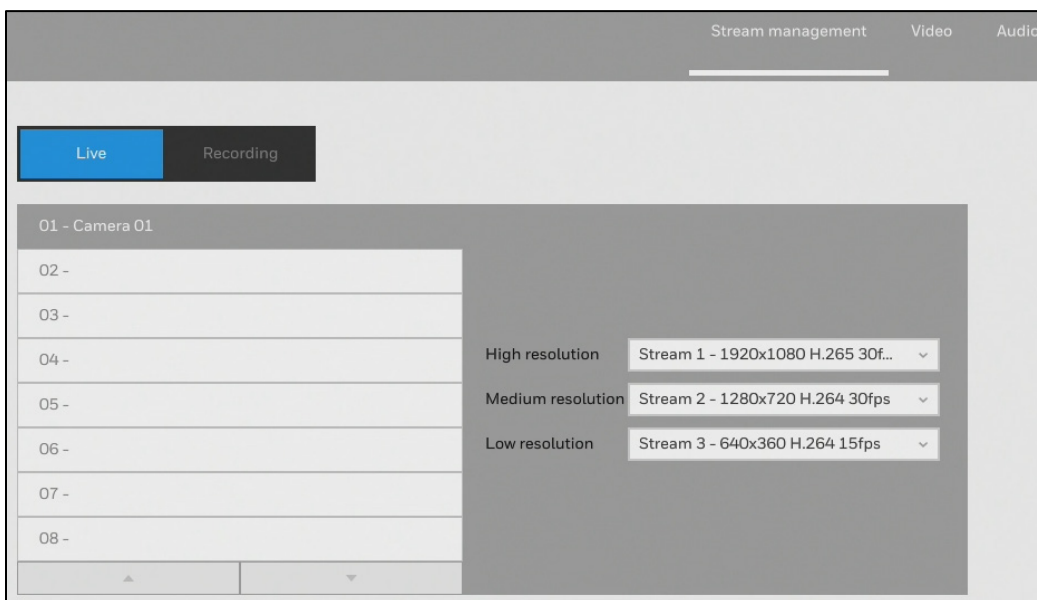
To change a camera's position on the Liveview layout, click and drag a camera to a desired position. Click **Apply** for the configuration change to take effect. The position screen displays the current layout on the Liveview screen.

## Setting-Camera-Media

### Stream Management

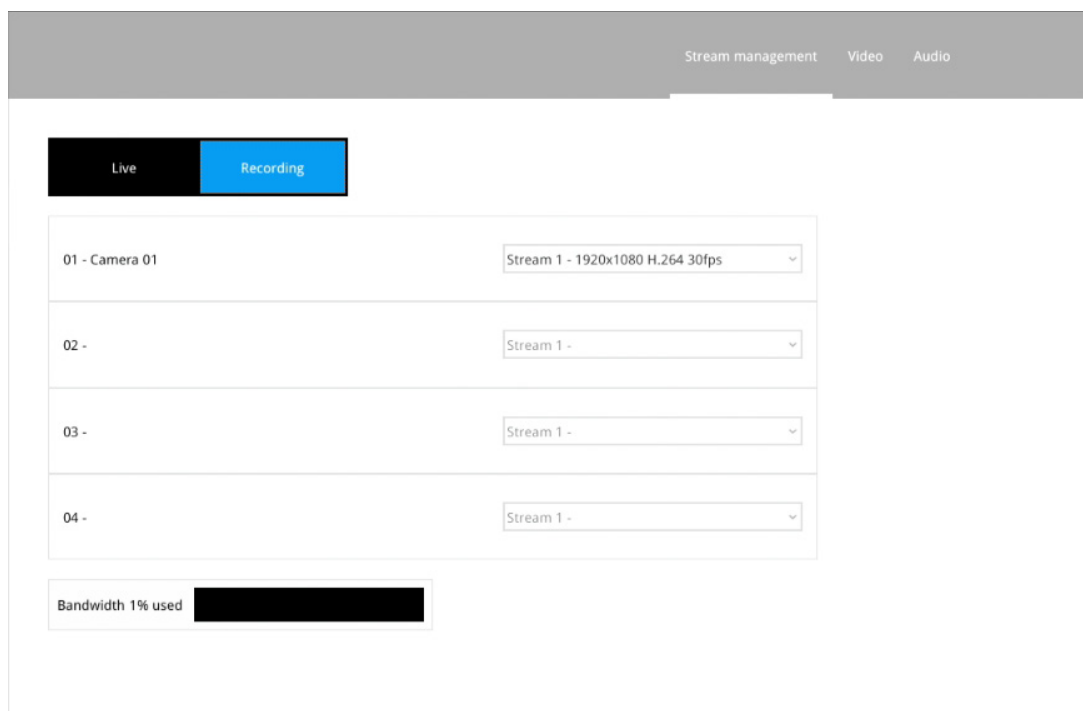
Go to  →  → Media → Stream management.

Figure 6-9 Media-Stream Management-Live



Click **Live** and you can manually select **High resolution**, **Medium resolution**, or **Low resolution** streams from the pre-configured video streams of a camera for live view.

**Figure 6-10 Media-Stream Management-Recording**



Click **Recording** and you can use these preset conditions to configure the resolution, image quality, frame rate, and the bandwidth consumption of the recording stream on this window.

---

**Note** Select MJPEG as codec and the maximum size of the frame size is 1920\*1920.

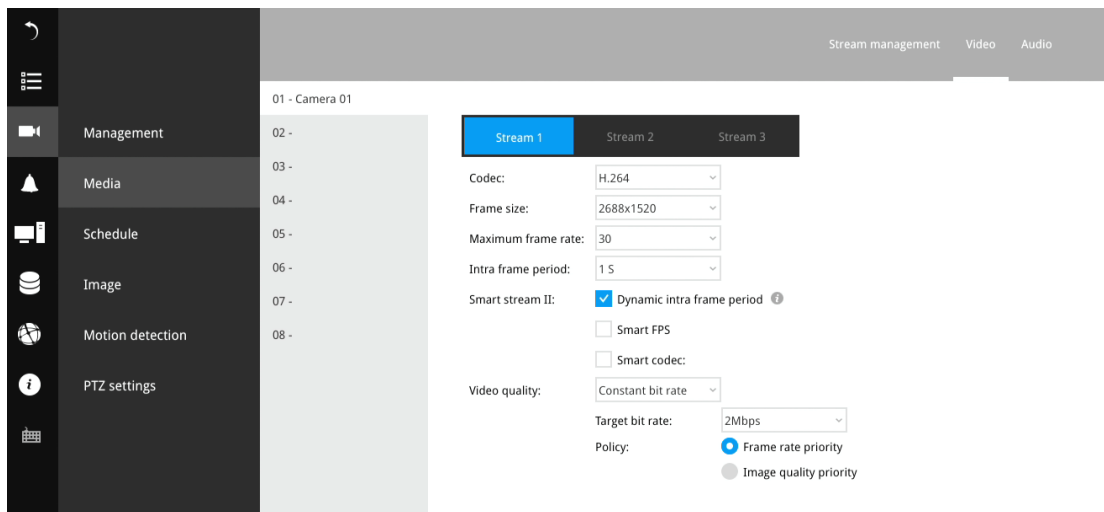
---

Click **Apply** for the configuration change to take effect.

## Video

Go to  →  → Media → Video.

Figure 6-11 Media-Video



The Video window allows you to configure all video streams (the no. of stream available can be different for different models). You can configure the following:

**Codec:** video compression codec in H.264, H265 or MJPEG.

**Frame size:** video resolution.

**Maximum frame rate:** the highest frame rate.

**Intra frame period:** how often an I-frame will be inserted into the video stream.

**Smart Stream II:** some newer camera models come with Smart Stream features.

- **Dynamic intra frame period:** High quality motion codecs, such as H.265, utilize the redundancies between video frames to deliver video streams at a balance of quality and bit rate. The encoding parameters are summarized and illustrated below. The I-frames are completely self-referential and they are largest in size. The P-frames are predicted frames. The encoder refers to the previous I- or P-frames for redundant image information.
- **Smart FPS:** In a static scene, the algorithm puts old frames in queue when no motions occur in scene. When motions occur, the encoding returns to normal to deliver real-time streaming.

By queuing the old frames from a static scene, both the computing efforts and the size of P frames are reduced. It is beneficial for keeping up with the frame rate requirements.

A default frame difference threshold, 1%, is embedded in firmware for returning from Smart FPS to normal encoding when motions occur.

- **Smart Codec:** Smart codec effectively reduces the quality of the whole or the non-interested areas on a screen and therefore reduces the bandwidth consumed.

**Video quality:** you may either select **Constant bit** rate or **Fixed quality** as the defining rules for video transmission:

Table 6-2 Video Quality

<b>Constant bit rate</b>	Places a packet size threshold on video frames; This guarantees the frame rate per second performance, yet
--------------------------	--

	image quality can be compromised if bandwidth is not sufficient in your network environment.
<b>Fixed quality</b>	Guaranteed video quality, and to ensure image quality, some frames may be dropped when bandwidth is not sufficient.

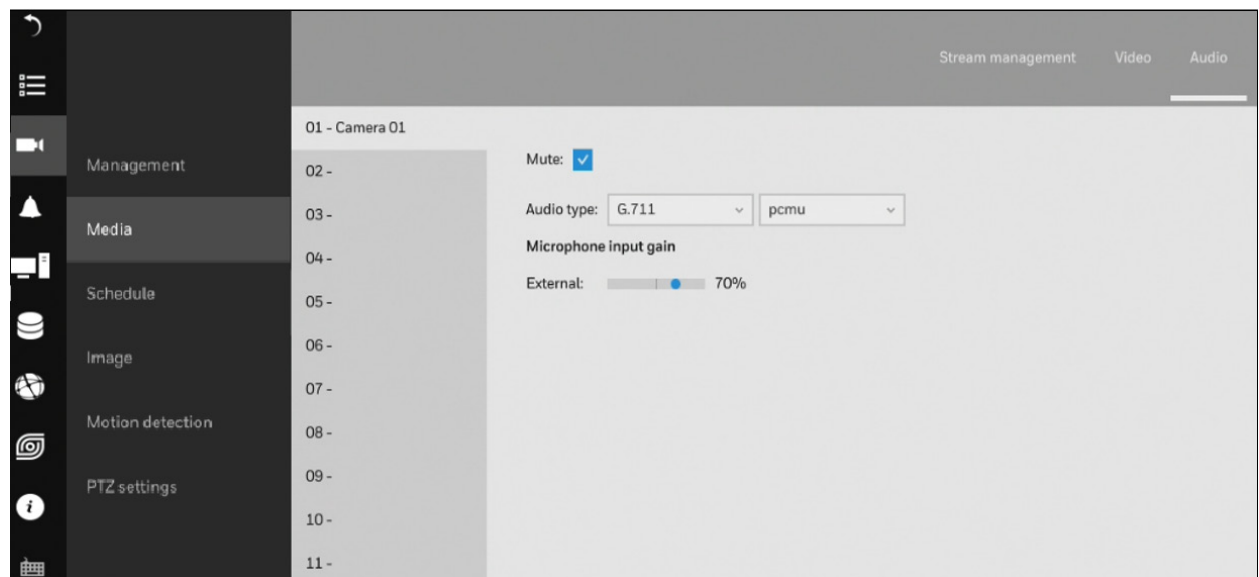
When the configuration is completed, click **Apply**.

## Audio

Go to  →  → **Media** → **Audio**.

The **Audio** window allows you to configure all audio codec, sampling rate, and Microphone input gains. Depending on design of the camera models, some codecs may not be available. Also, there are cameras that come without embedded microphones.

Figure 6-12 Audio



## Setting-Camera-Schedule

### Recording Options

Go to  →  → **Schedule** → **Recording options**.

Figure 6-13 Recording Options

On the **Recording options** page, you can configure the following:

**Event Duration:** Configure the duration of camera events, for the concern that camera can be too frequently triggered.

**Pre-event recording/ Post-event recording:** Enter the Pre-and Post-event recording time. The triggering events can be DI, DO, Motion detection, PIR, or Tampering detection. A recording length of 10 seconds of pre-event and up to 300 seconds of post-event can be configured.

**Stream:** The default recording stream is Stream 1, and the system automatically adjusts the frame rate, resolution, etc. for optimum performance. However, you can still change the streaming characteristics. Note that you cannot assign the recording task to another video stream.

**Other Options:** Enable or disable audio recording. Note that audio transmission through HDMI cable is currently not available. Change the life expectancy of the recording data.

## Schedule



Go to  →  → Schedule → Schedule.



Figure 6-14 Schedule

	0	1	2	3	4	5	6	7	8	9	10	11	12	13	14	15	16	17	18	19	20	21	22	23
All	Blue	Blue	Blue	Blue	Blue	Blue	Blue	Blue	Blue	Blue	Blue	Blue	Blue	Blue	Blue	Blue	Blue	Blue	Blue	Blue	Blue	Blue	Blue	Blue
Monday	Blue	Blue	Blue	Blue	Blue	Blue	Orange	Orange	Orange	Orange	Orange	Orange	Orange	Blue	White	White	White	White	White	Blue	Blue	Blue	Blue	Blue
Tuesday	Blue	Blue	Blue	Blue	Blue	Blue	Orange	Orange	Orange	Orange	Orange	Orange	Orange	Blue	White	White	White	White	White	Blue	Blue	Blue	Blue	Blue
Wednesday	Blue	Blue	Blue	Blue	Blue	Blue	Orange	Orange	Orange	Orange	Orange	Orange	Orange	Blue	White	White	White	White	White	Blue	Blue	Blue	Blue	Blue
Thursday	Blue	Blue	Blue	Blue	Blue	Blue	Orange	Orange	Orange	Orange	Orange	Orange	Orange	Blue	Blue	Blue	Blue	Blue	Blue	Blue	Blue	Blue	Blue	Blue
Friday	Blue	Blue	Blue	Blue	Blue	Blue	Orange	Orange	Orange	Orange	Orange	Orange	Orange	Blue	Blue	Blue	Blue	Blue	Blue	Blue	Blue	Blue	Blue	Blue
Saturday	Blue	Blue	Blue	Blue	Blue	Blue	Blue	Blue	Blue	Blue	Blue	Blue	Blue	Blue	Blue	Blue	Blue	Blue	Blue	Blue	Blue	Blue	Blue	Blue
Sunday	Blue	Blue	Blue	Blue	Blue	Blue	Blue	Blue	Blue	Blue	Blue	Blue	Blue	Blue	Blue	Blue	Blue	Blue	Blue	Blue	Blue	Blue	Blue	Blue

**Note** By default, all video feeds from cameras are recorded at all time (highlighted in blue).

You can modify the recording task using the schedule tool:

1. Select a camera and click to select a recording condition's checkbox—**Continuous recording**, **Event recording** and **Clear** (no recording).
2. Click and drag on the cells on the time table. For example, to stop the recording during a period, select the **Clear** checkbox and move the cursor across the time table. The minimum unit on the table is half an hour.
3. You may also use the scheduler tool on the right to facilitate the process.
  - a. Select a condition checkbox, and then select the **All day**, **Work hour**, **Off duty**, **Working day**, **Weekend** options to apply a time selection.
  - b. Repeat the process on individual cameras or select the Apply to all cameras if the schedule can apply to all cameras.
4. When the configuration is completed, click **Apply**.

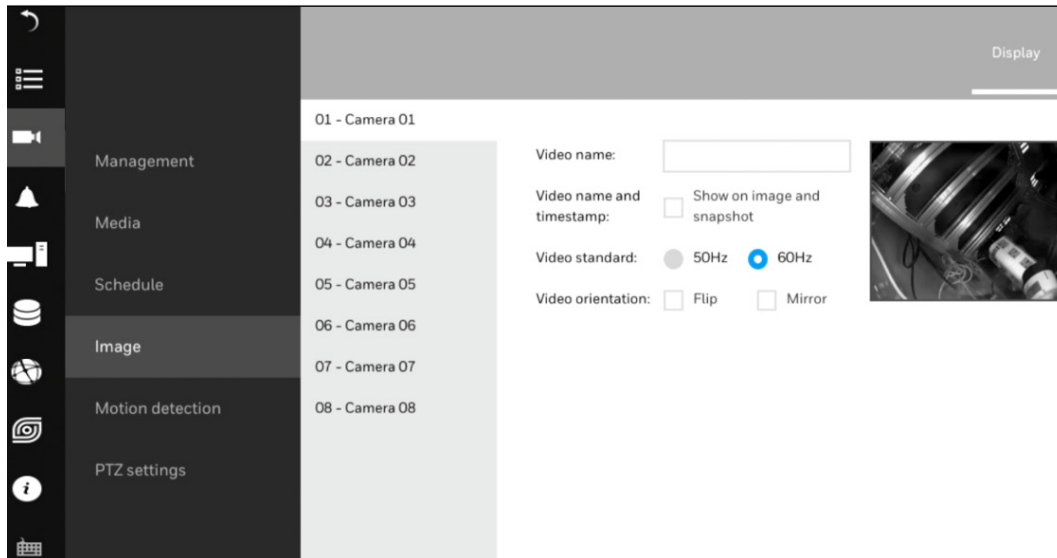
**Note** Event-triggered recording and continuous recording cannot be taking place at the same time.

# Setting-Camera-Image

## Display

Go to  →  → Image → Display.

Figure 6-15 Image-Display



The Display window allows users to tune the image display options:

**Video name:** The video name is displayed on the title bar that is displayed on each view cell. The screen shot below shows a name as "Speed dome."

**Video name and timestamp:** Default is enabled. If enabled, the video name and time is displayed on the view cell.

**Video Standard:** Depending on power line frequency of your country, select a matching option, NTSC 60Hz or PAL 50Hz, to avoid image flickering due to unmatched electricity.

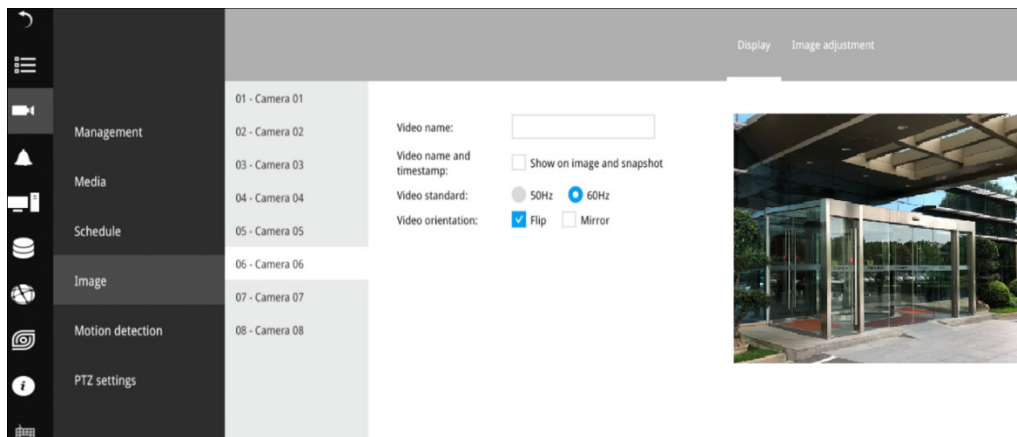
**Video orientation:** Select these options if the image from camera needs to be vertically or horizontally flipped.

Click **Restore** to poll for the original settings or click **Apply** to finish the process.

## Image Adjustment

Go to  →  → Image → Image Adjustment.

**Figure 6-16 Image-Adjustment**



The Image adjustment window allows users to tune the basics about image display options:

- Color
- Brightness
- Saturation
- Contrast
- Sharpness

High TV line, Gamma curve, low light compensation, etc. The rest of the options depend on the lens and image sensor type of each individual camera. Therefore, the options here can vary. For unique options coming with each individual camera, please refer to their User Manuals for more information.

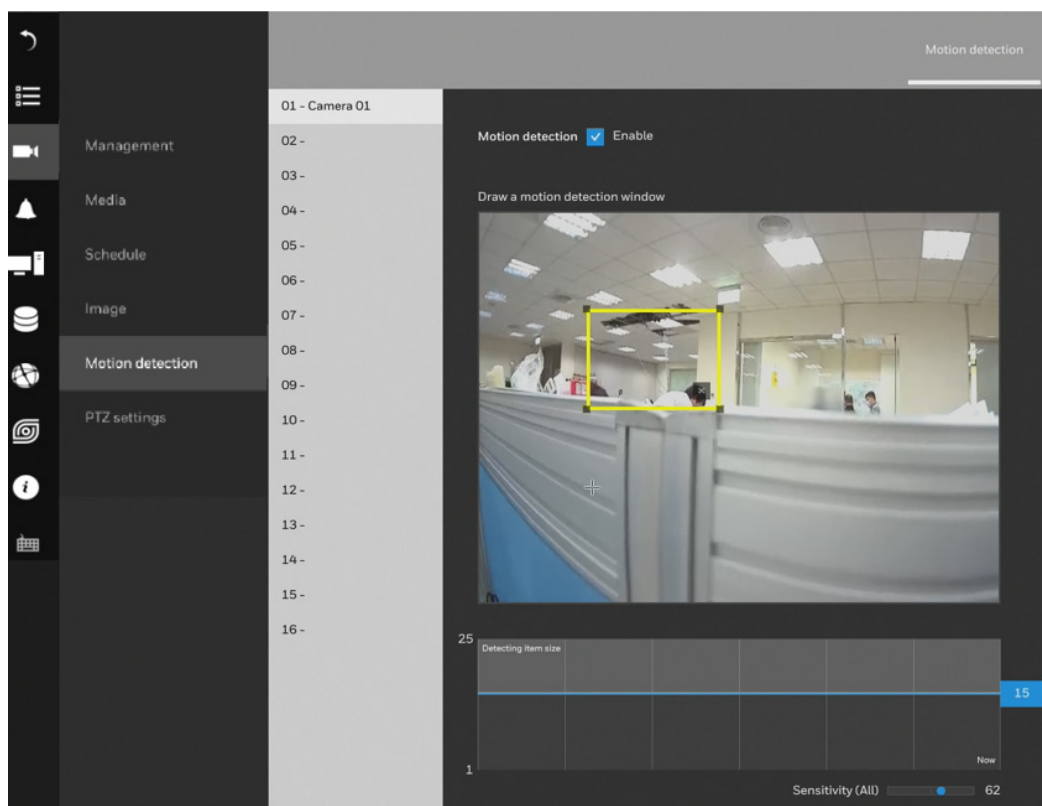
Click **Restore** to poll for the original settings or click **Apply** to finish the process. For features common among cameras, you may select the **Apply to all cameras** checkbox.

## Setting-Camera-Motion Detection

The Motion detection page allows you to set up a motion detection area.

Go to  →  → Motion detection.

Figure 6-17 Motion Detection



**Note** Up to 5 ROI windows can be created for a camera.

To set up a detection window:

1. Select a camera by a single click in the camera list.
2. Click and drag to draw a rectangular detection window.
3. Pull the detection area level up to a preferred position. An object must be larger than the detection area to trigger an alarm.
4. Select a Sensitivity level using the slide bar.
5. Click **Apply** for the configuration to take effect.

**Note** To have recordings on event trigger, you need to set up event schedule and create regular events at first. Please see [Schedule](#) on page 39 and [Creating an Event](#) on page 44.

## Setting-Camera-PTZ settings

Please see [Configuring PTZ Settings](#) on page 19.

## Setting-Event-Event

The events reported from individual cameras' alarm in /alarm out, and motion detection can be accommodated in the NVR system's alarm settings. These events will then be reported or trigger corresponding actions as follows:

- **Record** the video by the time the event is triggered.
- Reporting events via **Email** with **snapshots** attached.
- Sound the onboard **buzzer**.
- Triggering video snapshot and text message by the occurrences of events to an **FTP** site.
- Triggering a camera's alarm out.
- Triggering a **PTZ** camera(s) for its lens to move to a **preset** position.
- Sending notification to the HVMV for MS Window software.
- Sending a **full screen** live view on the connected monitor.

When an alarm is triggered, a message prompt will appear on the Liveview or any configuration window.

Figure 6-18 Event




## Creating an Event

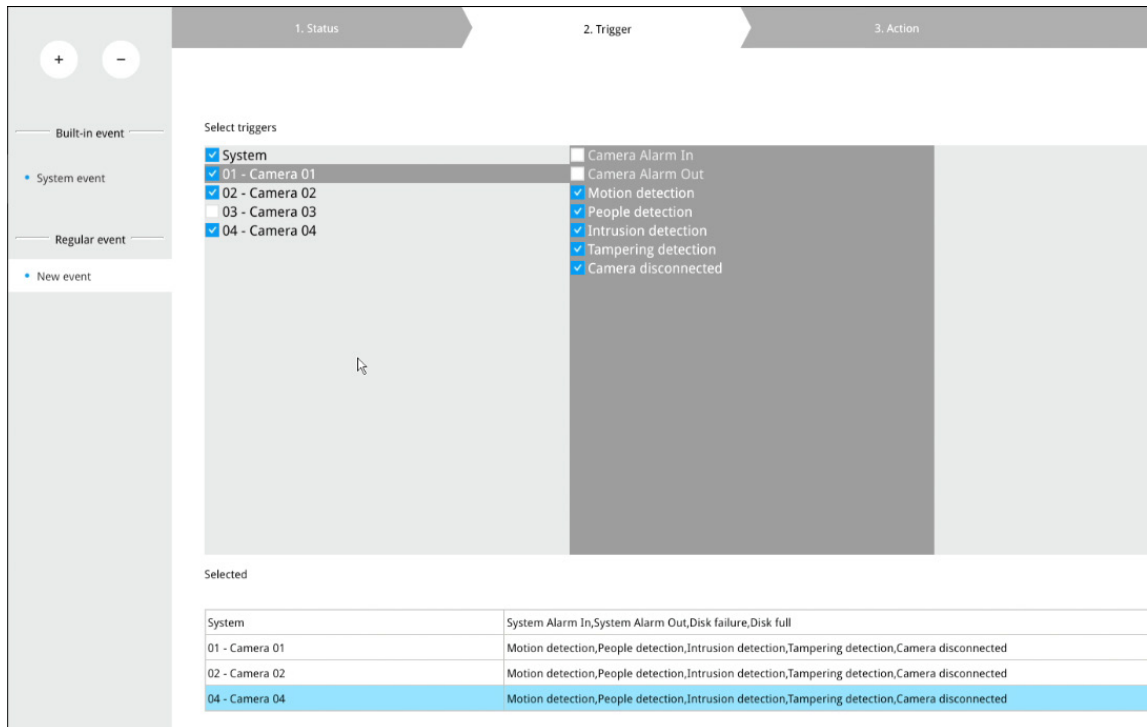
Go to  →  → Event.

1. Click  and the following window is displayed:


Figure 6-19 Create a New Event-Status

- Manually enter a name. Up to 16 numeric or alphabetic characters is supported for the name, including symbols such as [0-9] [a-z] [A-Z] [\_] [.]. And then designate the interval between one alarm and the next triggered alarm to avoid the situation that the alarms can be too frequently triggered. Click  and the following window is displayed:

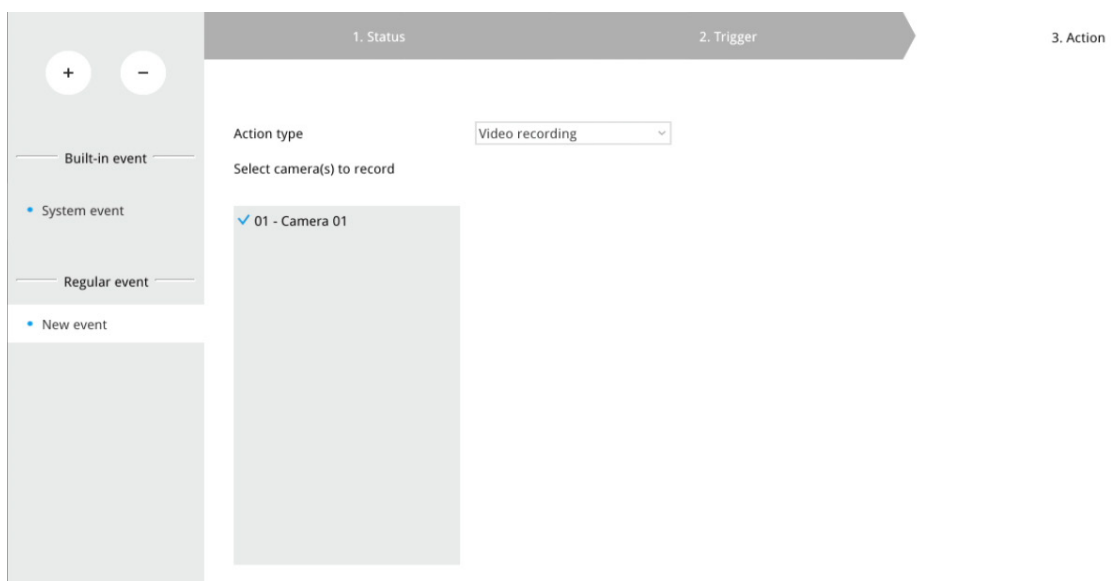
**Figure 6-20 Create a New Event-Trigger**



Selected	
System	System Alarm In, System Alarm Out, Disk failure, Disk full
01 - Camera 01	Motion detection, People detection, Intrusion detection, Tampering detection, Camera disconnected
02 - Camera 02	Motion detection, People detection, Intrusion detection, Tampering detection, Camera disconnected
04 - Camera 04	Motion detection, People detection, Intrusion detection, Tampering detection, Camera disconnected

- Select system triggering conditions, or one or more cameras by selecting their checkboxes. Click  and the following window is displayed:

**Figure 6-21 Create a New Event-Action**

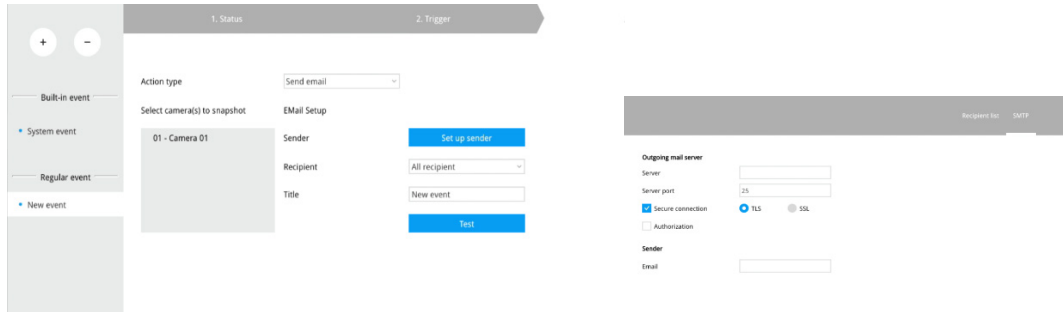


- Select the Action type from a drop-down menu which includes:

**Video recording** – When an event is triggered, the selected camera will record a video footage of the length defined by the pre-/post-event setting, to the NVR system.

**Send email** – When an event is triggered, it sends an Email to the administrator along with a snapshot of the event.

**Figure 6-22 Email Setup**



To configure Email notification, enter valid Email addresses as the Sender and Recipient addresses, an Email subject, and the SMTP server address through which the Email will be delivered. If you need to log in to SMTP server to deliver an Email, enter the User name and password for access to that account.

**Note**

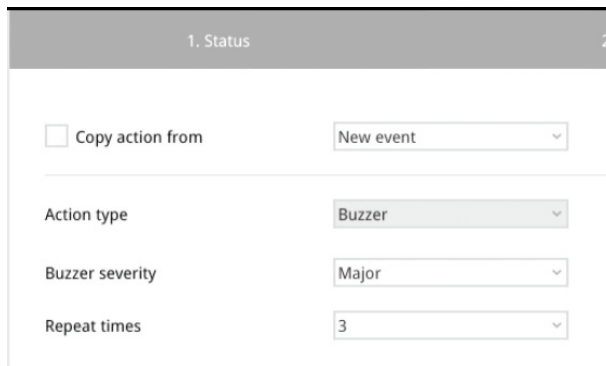
The Email subject and addresses can be composed of 254 characters in numeric or alphabetic characters including: [0-9] [a-z] [A-Z] [\_] [ ][-].[,][@]. You can enter the addresses of multiple recipients. Use semicolons, (;), to separate the addresses of multiple recipients.

**Buzzer** – The buzzer is sounded on the occurrence of the event. The buzzer tones are categorized into: **Major** (1 long 2 shorts, 1 sec interval), **Normal** (3 shorts, 2 sec interval) and **Minor** (2 shorts, 2 sec interval) depending on the importance of an event. Select a Buzzer modulation from the drop-down list.

A long tone has a duration of 1 second, while a short tone 0.5 second. A very short tone lasts only for 0.1 second.

Select how many times the buzzer tones will be repeated on the occurrence of an event.

**Figure 6-23 Buzzer Setup**



If events of different importance are issued at the same time, e.g., one major and one minor event, system will ignore the minor event and sound the buzzer tone for the major

event only. The buzzer can be sounded either by the Alarm actions or the system events. If Alarm actions and system service events occur at the time, Alarm actions have the higher priority.

If multiple Alarm actions occur, the currently-sounded events can be depleted by the new event.

There are conditions that the system will sound the buzzer, and the conditions are not configurable.

- **Disk failure** - missing drives or SMART detected failures.
- **Disk full** - the free space is too small for recording tasks.

**FTP**—Snapshots from specified cameras can be uploaded to an FTP site on the occurrence of an event. Enter the FTP site address in the dotted-decimal notation, e.g., 159.22.151.20. Enter the login name and password for the user account. You can enter a directory name you prefer on the FTP site. The server port default is 21, a different number between 1025 and 65535 can also be assigned.

The snapshot thus delivered has a size of 320x240 pixels. If authentication is not applied, login will proceed using the [anonymous] account. The file names of the snapshot jpeg files will look like this: [MAC]\_[DATE]\_[TIME]\_[CAMERA\_INDEX].jpg - If similar files already exist, an additional index number will be added to the end of file name.

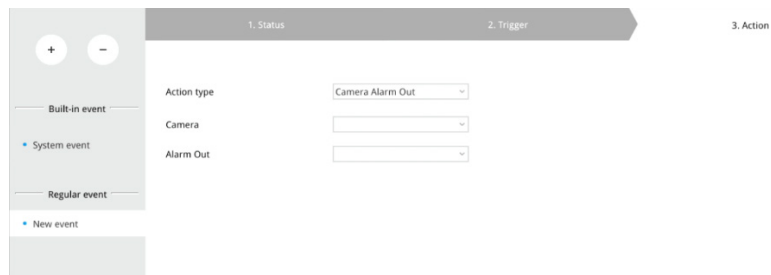
**Figure 6-24 FTP Setup**

The screenshot shows the '2. Trigger' configuration tab. At the top, there are two tabs: '1. Status' and '2. Trigger'. Below the tabs, there is a checkbox labeled 'Copy action from' with a dropdown menu set to 'New event'. Below this, there is a section for 'Action type' with a dropdown menu set to 'FTP'. To the left of the 'FTP setup' section, there is a list of cameras: '02 - Camera 02' and '03 - Camera 03'. The 'FTP setup' section includes the following fields: 'FTP server' (text input), 'Port' (text input with '21' entered), 'Authorization' (checkbox labeled 'Enable'), 'Username' (text input), 'Password' (text input), and 'Upload folder:' (text input with a slash '/' entered). At the bottom right of the 'FTP setup' section, there is a blue button labeled 'Upload test file'.

**Camera Alarm Out** - A triggered alarm triggers a camera's alarm out, e.g., an alarm siren.

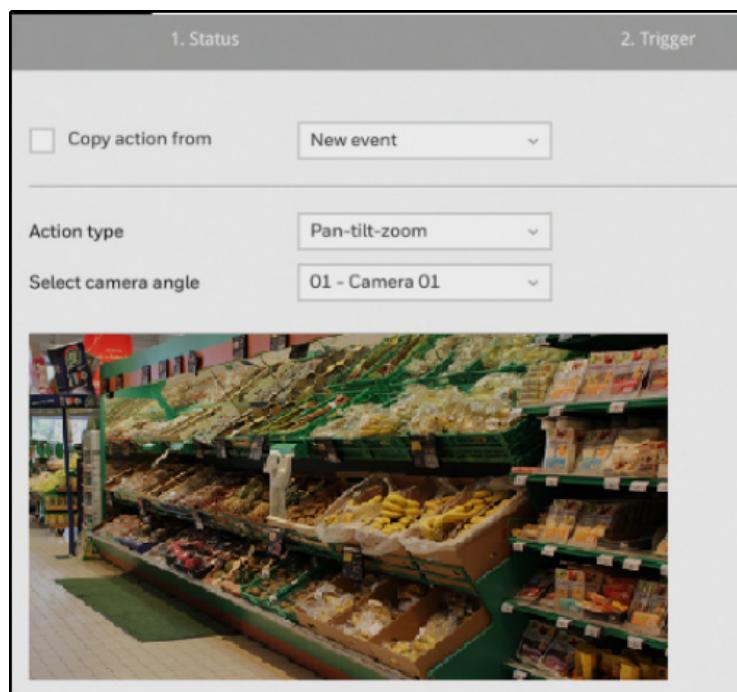


**Figure 6-25 Camera Alarm Out Setup**



**Pan-tilt-zoom** - A PTZ capable camera can move its lens to the preset position in case of a triggered alarm. For example, a triggered sensor may indicate an area of interest has been intruded, and a camera's field of view should be moved to cover that area. The precondition is that you properly set up preset positions on your PTZ cameras using a local or a web console.

**Figure 6-26 Pan-tilt-zoom setup**



**HTTP** - Select to send the media files to an HTTP server when a trigger is activated.

Figure 6-27 HTTP Setup

**System Alarm Out** - A triggered alarm can be used to toggle the NVR's alarm out, e.g., to sound an alarm siren.

Figure 6-28 System Alarm Out

**Send to HVMV**—An event message will display on your HVMV mobile app.

---

**Note**

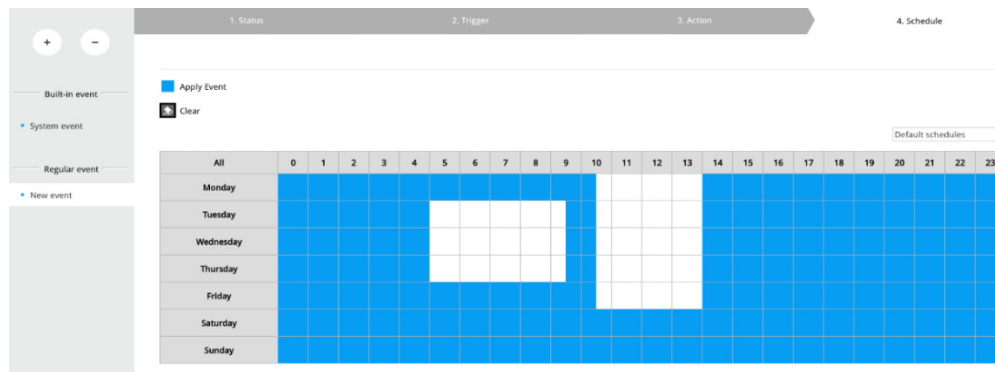
For using the push notification function of HVMV mobile app, you need to select **send to HVMV** for **Action type** in NVR event configuration.

---

Figure 6-29 Send to HVMV

- Click  and the following window is displayed:



Figure 6-30 Event Schedule



6. Click and drag the mouse to activate or de-activate alarm triggers throughout a specific timeline.
7. Click **Finish** to end the configuration.
8. Repeat the process above to create more alarms according to the needs in your surveillance deployment.

## Removing an Event

Go to  →  → **Event**.

1. Click  and the remove button displays as .
2. Mouse over to the event you want to remove, and its entry will display the Remove message.
3. Click the **Remove** message.

## Setting-Event-Email

This page provides an interface where you can configure the connection to a Mail server. via the Mail server, the system can deliver Emails containing system alarm messages to multiple receivers. A reachable Mail server and Email accounts must be provided before you can apply the settings.

Go to  →  → **Email**.

The configuration options are identical to those found in the Email configuration in **Settings - Event** window. See [Email Setup](#) on page 46.

## Setting-System-Information

Go to  →  → **Information**.

Figure 6-31 System-Information

**Name and language**

System name

Language

**Time**

Set system date and time

**Time zone**

Set up Network - IP - DNS server to update Daylight Saving Time

**Manual setup**

- 1 Download update file from <https://www.iana.org/time-zones>
- 2 Save file to USB device
- 3

On this window, you can configure the following:

- Change the system name. Using a name in different languages is supported via a web console.
- Select the UI text language.
- Configure system time, time zone, and if you are connected to a DNS server where Auto Daylight Saving time can be applied, you can acquire the associated setting from a server within your network. You can use the Auto Setup button to automatically update the daylight-saving configuration. A system reboot is required.
- Manually update the daylight-saving profile in the GZ format using the Import file button below.

Click **Apply** for the configuration to take effect.

---

**Note**

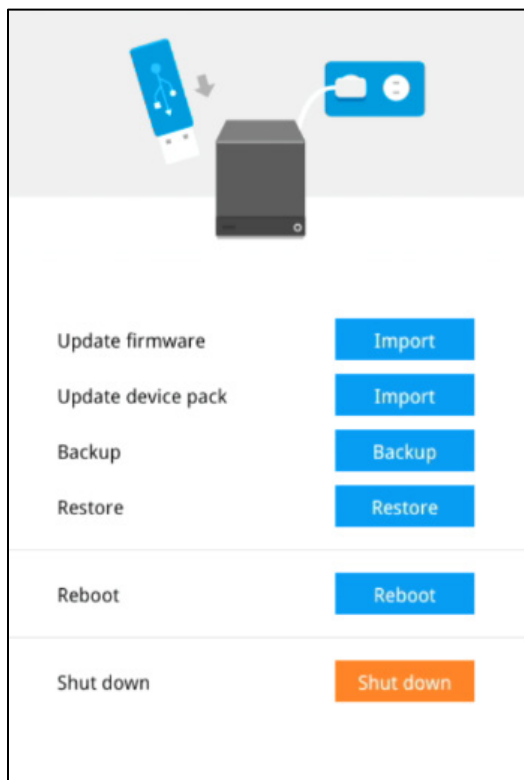
If the **NTP** time server configuration (Auto) is preferred, the system will automatically configure all cameras to be listening to the system, and therefore to the same time server.

---

## Setting-System-Maintenance

Go to  →  → Maintenance.

Figure 6-32 Maintenance



On this window, you can perform 4 maintenance tasks:

- **Update firmware** –Download firmware and save it to a USB drive in the FAT format, attach the USB device to the NVR for firmware upgrade.
- **Update device pack**–A device pack allows you to import associated configurations and parameters for new camera models so that these cameras can be integrated into your NVR configuration. The information in the device pack is related to some tunable parameters.
- **Backup** –You can back up your system configuration using the Backup function. Click **Backup**, a message window will prompt. Click **Save** to preserve your system configurations.

Select a location for your backup file, then click **Save** to complete the process. If you back up to a USB thumb drive, that thumb drive must be formatted using the FAT format.

---

The backup action does not involve the following:

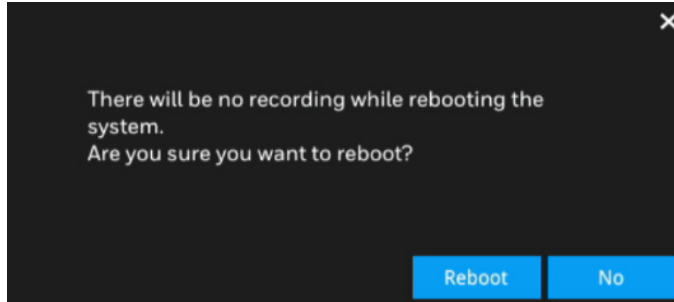
- Note**
- Recorded videos and database.
  - Alarm records

- 
- **Restore**–If you have a previously-saved profile, you can restore your previous configuration. Click **Restore**. A file location window will prompt. Locate the backup file and

click **Open**. The Restore process will take several minutes to complete, and system operation will be interrupted during the process.

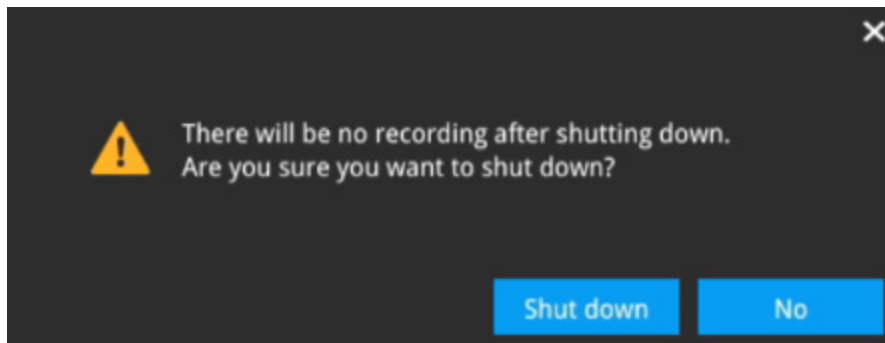
- **Reboot** – Click the button to reboot NVR.

Figure 6-33 Reboot



- **Shutdown** – Click the button to shutdown NVR.

Figure 6-34 Shutdown



Refer to the following table for detailed information on compatible USBs.

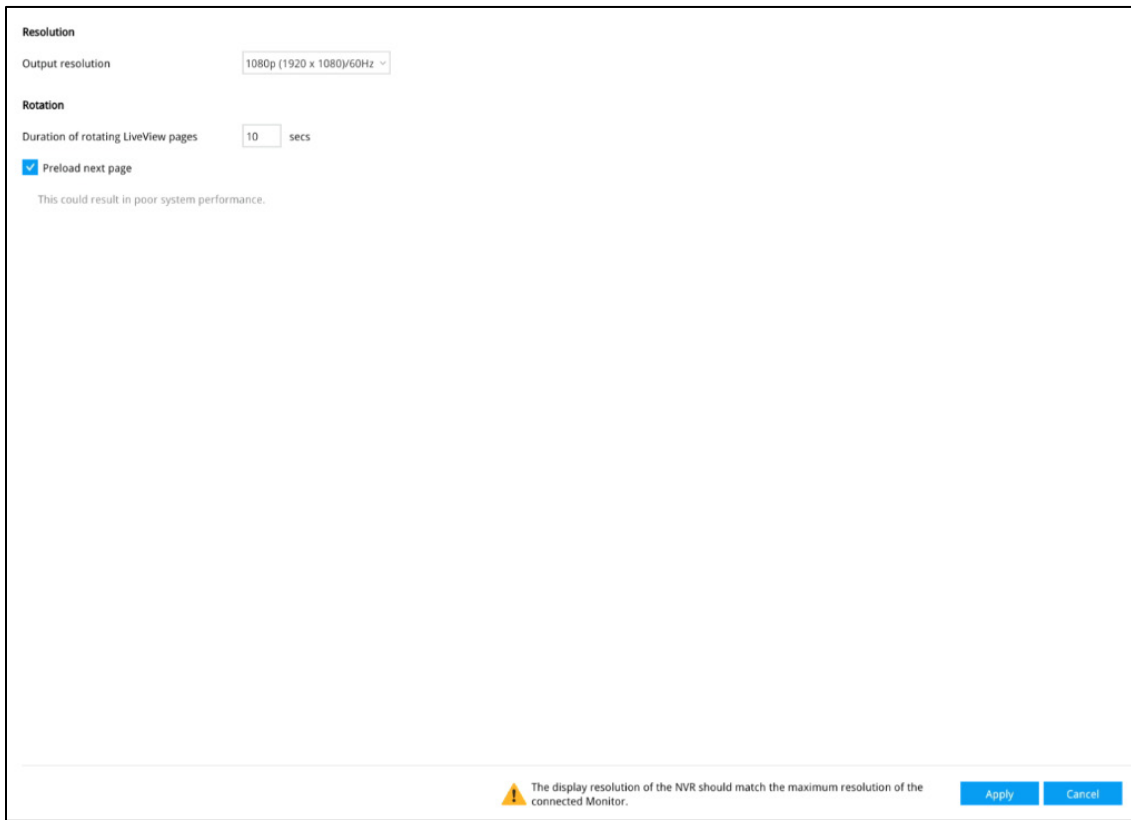
Table 6-3 Compatible USB Table

Brand	Specification
Transcend	TS8GJF370 8GB, USB2.0, Pen Drive, Classic, White
SanDisk	SDCZ73-032G-G46, SanDisk Ultra Flair USB 3.0 32GB
	SDCZ600-032G-G35, SanDisk Cruzer Glide 3.0 32GB
Sony	USM16GL, microvault USB2.0 16GB

## Setting-System-Display

Go to  →  → Display.

**Figure 6-35 Display**



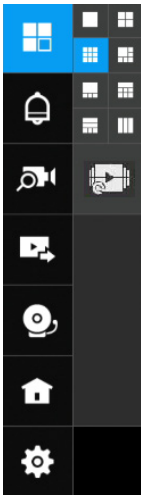
On this page, you can configure the system to consecutively display (rotate) cameras' view cells on the Liveview window. For example, if you have 8 cameras in 2 2x2 layouts, the rotation can let you see the live views of all cameras by every few seconds.

After checking **Preload next page**, the next page will be preloaded with smooth rotation and the loading status will be invisible in live view.

You can check the video for your reference.

To enable the rotate function, click  on the layout panel.

Figure 6-36 Layout



## Setting-System-Log

Go to  →  → Log.

System logs are categorized as **System**, **Recording**, **User**, and **Error**. You can search for past logs in each category window by selecting a range of time and clicking **Search**

Figure 6-37 System Log-System

System Recording User Error					
From	To				
January 13 2021	January 14 2021	<input type="button" value="Search"/>			
8 result(s)					
Date	Level	Source	Message		
2021.01.14 00:41:55	INFO	system service	DHCP renew: Interface:eth0, Address:192.168.1.175, Subnet mask:255.255.255.0, Gateway:1...		
2021.01.14 00:40:45	INFO	User: admin	System reboot		
2021.01.13 21:14:08	INFO	system service	DHCP renew: Interface:eth0, Address:192.168.1.175, Subnet mask:255.255.255.0, Gateway:1...		
2021.01.13 11:40:54	INFO	system service	DHCP renew: Interface:eth0, Address:192.168.1.175, Subnet mask:255.255.255.0, Gateway:1...		
2021.01.13 01:26:36	INFO	system service	DHCP renew: Interface:eth0, Address:192.168.1.175, Subnet mask:255.255.255.0, Gateway:1...		
2021.01.13 01:05:33	INFO	system service	DHCP renew: Interface:eth0, Address:159.99.251.208, Subnet mask:255.255.255.0, Gateway:1...		
2021.01.13 00:36:38	INFO	system service	DHCP renew: Interface:eth0, Address:159.99.251.208, Subnet mask:255.255.255.0, Gateway:1...		
2021.01.13 00:07:59	INFO	system service	DHCP renew: Interface:eth0, Address:159.99.251.208, Subnet mask:255.255.255.0, Gateway:1...		



Figure 6-38 System Log- Recording

System Recording User Error					
From	To				
13 2021	January 14 2021	Search			
19 results					
Date	Camera	Source	Message		
2021.01.14 00:43:47	1	camera service	Camera online		
2021.01.14 00:43:47	2	camera service	Camera online		
2021.01.14 00:43:15	4	camera service	Camera online		
2021.01.14 00:42:04	2	recording service	Schedule recording starts recording period		
2021.01.14 00:42:03	1	recording service	Schedule recording starts recording period		
2021.01.14 00:42:03	4	recording service	Schedule recording starts recording period		
2021.01.14 00:42:03	3	recording service	Schedule recording starts recording period		
2021.01.13 01:33:57	1	camera service	Camera online		
2021.01.13 01:33:53	1	camera service	Camera offline		
2021.01.13 01:28:47	4	camera service	Camera online		
2021.01.13 01:28:31	3	camera service	Camera online		
2021.01.13 01:28:21	2	camera service	Camera online		
2021.01.13 01:27:54	4	camera service	Camera offline		
2021.01.13 01:27:48	3	camera service	Camera offline		
2021.01.13 01:27:41	2	camera service	Camera offline		
2021.01.13 01:26:39	2	recording service	Schedule recording starts recording period		
2021.01.13 01:26:39	1	recording service	Schedule recording starts recording period		
2021.01.13 01:26:39	4	recording service	Schedule recording starts recording period		
2021.01.13 01:26:39	3	recording service	Schedule recording starts recording period		

Figure 6-39 System Log- User

System Recording User Error					
From	To				
13 2021	January 14 2021	Search			
12 results					
Date	Source	Username	Message		
2021.01.14 00:43:46	local	admin	Login		
2021.01.14 00:38:47	local	admin	Login		
2021.01.13 02:31:57	local	admin	Logout		
2021.01.13 02:16:16	local	admin	Login		
2021.01.13 02:12:33	local	admin	Logout		
2021.01.13 02:02:22	local	admin	Login		
2021.01.13 02:01:42	local	admin	Logout		
2021.01.13 02:00:31	local	admin	Login		
2021.01.13 02:00:14	local	admin	Login		
2021.01.13 01:51:33	local	admin	Logout		
2021.01.13 01:30:11	local	admin	Login		
2021.01.13 01:09:16	159.99.251.148	admin	Login		

Figure 6-40 System Log- Error

System Recording User Error					
From	To				
January 13 2021	January 14 2021	Search			



## Setting-User

Go to  →  → User.

Figure 6-41 User Page

The screenshot shows the 'User Page' interface. On the left, there is a sidebar with a 'Current user' section containing a '+' and '-' button, and a list of users with 'admin' selected. Below this is an 'Other users' section. The main content area displays the details for the selected user 'admin':

- Username:** admin
- Buttons:** Change password (blue button), Reset security question (blue button)
- Group:** Administrator (dropdown menu)
- Camera access:** All cameras

The User page allows you to create more users, to change user password, reset security question and place limitations on users' privileges and administration rights. Up to 16 users can be created, including the default administrator.

---

**Note** For password resetting, you can set security questions after password initialization (See [Device Initialization](#) on page 9) or on the user page by clicking **Reset security question**.

---

Figure 6-42 Reset Security Questions 1

This screenshot shows the same 'User Page' interface as Figure 6-41, but with a modal dialog box open for the 'admin' user. The dialog box is titled 'Reset security questions' and contains:

- Current password:** A text input field with a blue border and a small 'x' icon to its right.
- Reset security question:** A blue button.

The background interface remains the same, showing the 'admin' user details and the 'Reset security question' button.

**Figure 6-43 Reset Security Questions 2**

By default, there are two user groups: **Administrator** and **Regular user**.

- The administrator users can access all cameras recruited in the configuration.
- The regular users can be configured to have access to some or all cameras and the regular users can use only the live view and playback features for the assigned cameras. The regular users cannot access the Settings window, meaning that regular users cannot add or remove cameras, make changes to alarm, network, and all other system settings. When users try to access the Settings window, the login window prohibits regular users to log in.

The system blocks out the video feeds from users who are denied of the access to particular cameras. The alarms and the alarm-triggered recordings from those cameras will also be inaccessible for unauthorized users.

---

**Note** The default name and password for administrator group are **admin** and **admin**. It is highly recommended to change the default password to prevent unauthorized access to the system.

---

## Creating a User


1. Click  in [Figure 6-36](#) and the following window is displayed:

Figure 6-44 Create a User

Authorization	All
01 - Camera 01	<input type="checkbox"/>
02 - Camera 02	<input type="checkbox"/>
03 - Camera 03	<input type="checkbox"/>
04 - Camera 04	<input type="checkbox"/>
05 - Camera 05	<input type="checkbox"/>
06 - Camera 06	<input type="checkbox"/>
07 - Camera 07	<input type="checkbox"/>
08 - Camera 08	<input type="checkbox"/>



2. Enter username, password and select a group from the dropdown menu.

#### Note

- The maximum number of characters for a username is 64, with alphabetic and numeric characters including [0-9] [a-z] [A-Z] [-] [ ] [-] [.] [,] [ @]. The maximum number for password is also 64.
- If you are creating a regular user with limited access to cameras, deselect the checkboxes by the cameras to deny the user access.

3. Click **Apply** to close the configuration window. Repeat the process to create more users.

## Removing a User

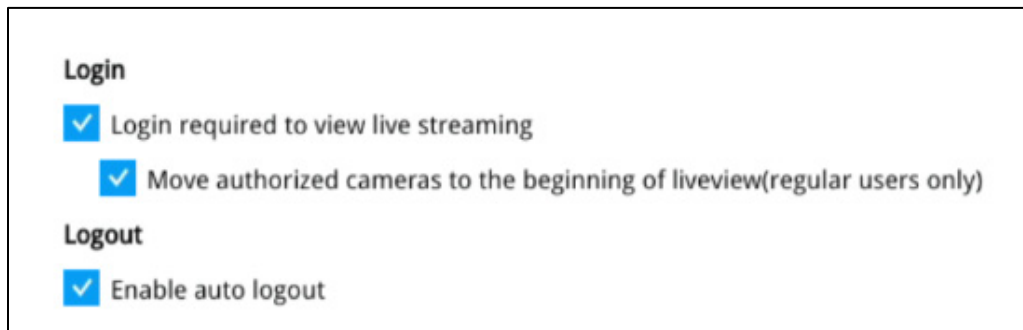
1. Click  in [Figure 6-36](#) and the remove button displays as .
2. Mouse over to the user you want to remove, and its entry will display the Remove message.
3. Click on the **Remove** message.

## Setting-Login/Logout

Go to  →  → Login / Logout.

Select related settings of login/logout.

Figure 6-45 Login/Logout



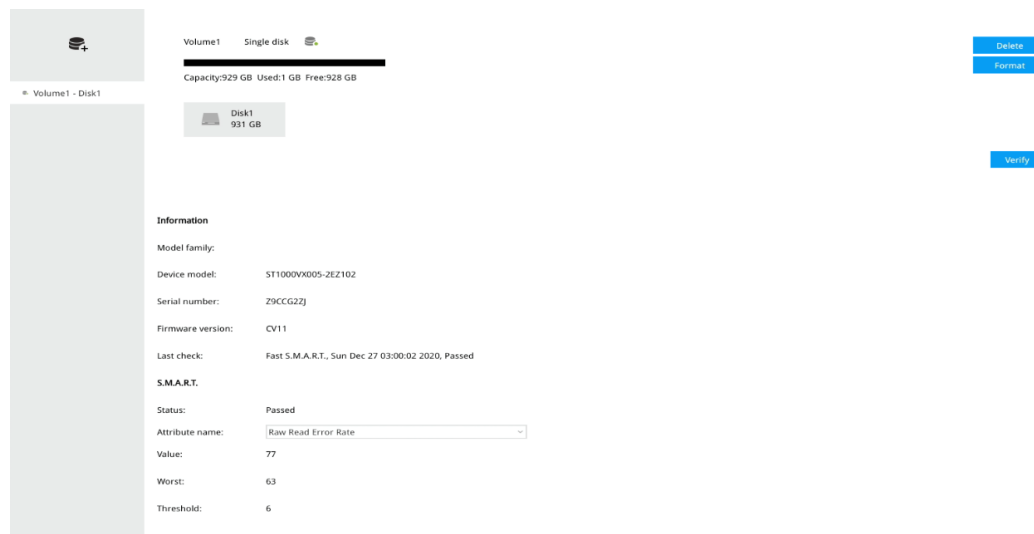
## Setting-Storage

### Creating a Volume

Before creating the volume, make sure the HDDs have been properly installed.

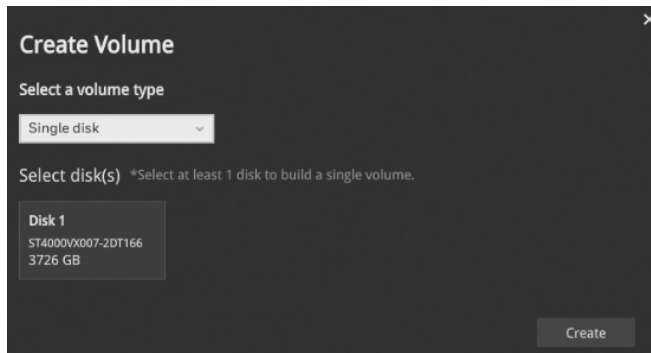
Go to  →  → Storage.

Figure 6-46 Setting-Storage



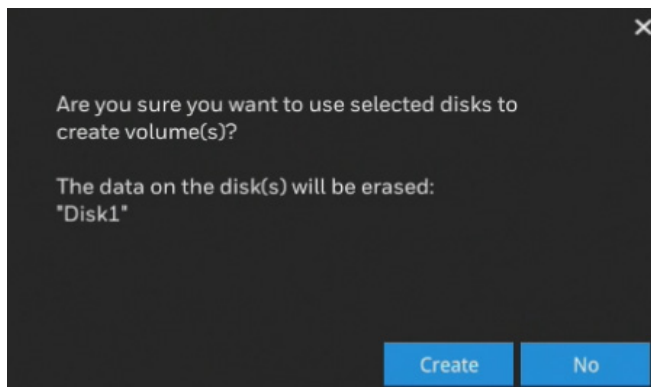
1. Click  and the following window is displayed:

Figure 6-47 Select Disk



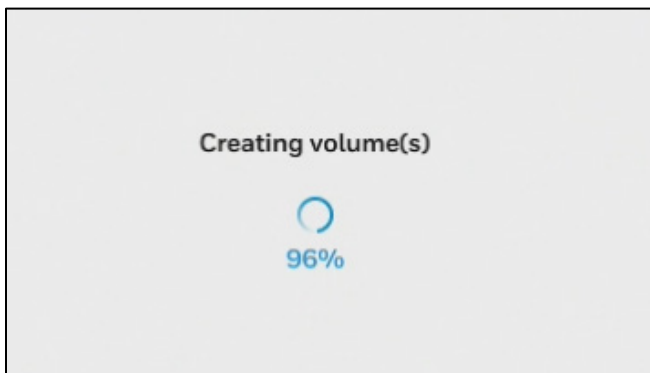
2. Click a disk that you want to use and click **Create**. A confirm message prompted as below:

Figure 6-48 Confirm



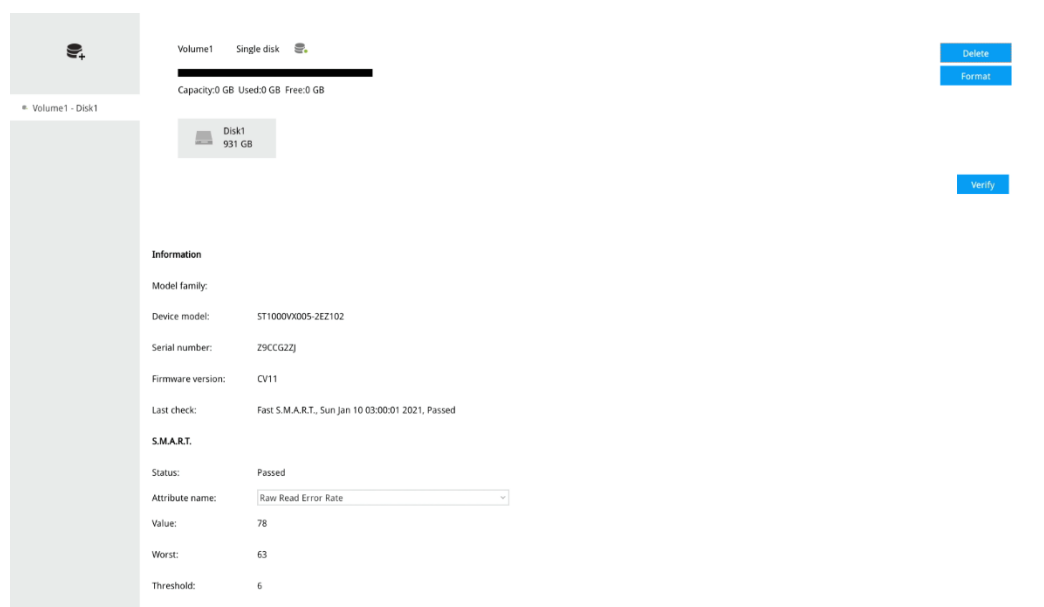
3. Click **Create** to proceed.

Figure 6-49 Creating Volume



When the creating is completed, the following window is displayed:

Figure 6-50 Volume



Repeat the above steps to create a new volume when you installed another disk.

The storage page displays the volume information including physical position, total capacity, used and free space, and associated commands such as Format and Delete. Since each volume contains only 1 hard drive, detailed information about the hard drive is also displayed on this page.

You can format an existing storage volume in situations such as when you need to re-deploy the system elsewhere.

### Disk Information

**Model family:** The brand name of the HDD manufacturer.

**Device model:** The disk model name.

**Serial number:** Serial number assigned to the disk drive.

**Firmware version:** The version of firmware running on this disk drive.

**Last check:** The bad block check or S.M.A.R.T. test previously executed on this drive.

**Status:** S.M.A.R.T. status polled from the disk drive. This is not the results from a manually-executed S.M.A.R.T. test.

**Attribute name:** The various attributes can vary from different HDD manufacturers. Value: Value for the currently selected attribute.

**Value:** The detected parameters for that attribute.

**Worst:** Worst value acquired for that attribute.

**Threshold:** A predefined threshold or triggering value. The threshold below which the normalized value will be considered exceeding specifications.

**Status:** The judgement made to deem the current reading as OK or failed.

## Verify

Click **Verify** on [Figure 6-42](#) to check the disk status. Three types of check disk actions can be initiated through this button.

**Bad Block:** Performs read/write test to drive sectors to locate bad blocks. This action may take several hours to complete.

**Fast S.M.A.R.T.:** Tests the electronic and mechanical performance and disk read performance, including those on disk buffer, read head, seek time, and integrity of drive sectors. The short test is performed on a small section of disk platters, and takes about 2 minutes to complete.

**S.M.A.R.T.:** The long test is more thoroughly and is performed to all drive sectors. The actual completion time depends on drive sizes and the attributes put to test.

The Check disk functions mentioned above, when performed during active I/Os, can consume system resources and cause dropped frames with the recording tasks.

---

**Note** Disk verify function requires a volume to be temporarily disabled; namely, the video recording will be stopped before disk verify can be performed.


---

## Setting-Network

### Settings-Network-IP

Go to  →  → IP.

Figure 6-51 IP

IP Configuration:	<input type="text" value="DHCP"/>	
Mac:	00:40:84:f8:c3:49	
IP:	169.254.248.151	
Subnet mask:	255.255.0.0	
Gateway:		
DNS server 1:		
DNS server 2:		
POE DHCP:	<input type="text" value="10.1.1.1"/>	

**DHCP:** Default is selected, the server obtains an available dynamic IP address assigned by the DHCP server each time the system is connected to the LAN.



**Manual setup:** Select this option to manually assign a static IP address to the NVR. Enter the Static IP, Subnet mask, Default router, and Primary DNS provided by your ISP.

**Mac:** This is the Mac address.

**Subnet mask:** This is used to determine if the destination is in the same subnet. The default value is “255.255.255.0”.

**Gateway:** This is the default router used to forward frames to destinations in a different subnet. Invalid router setting will fail the transmission to destinations in different subnet.

**DNS Server 1:** The primary domain name server that translates hostnames into IP addresses.

**DNS Server 2:** Secondary domain name server that backups the Primary DNS.

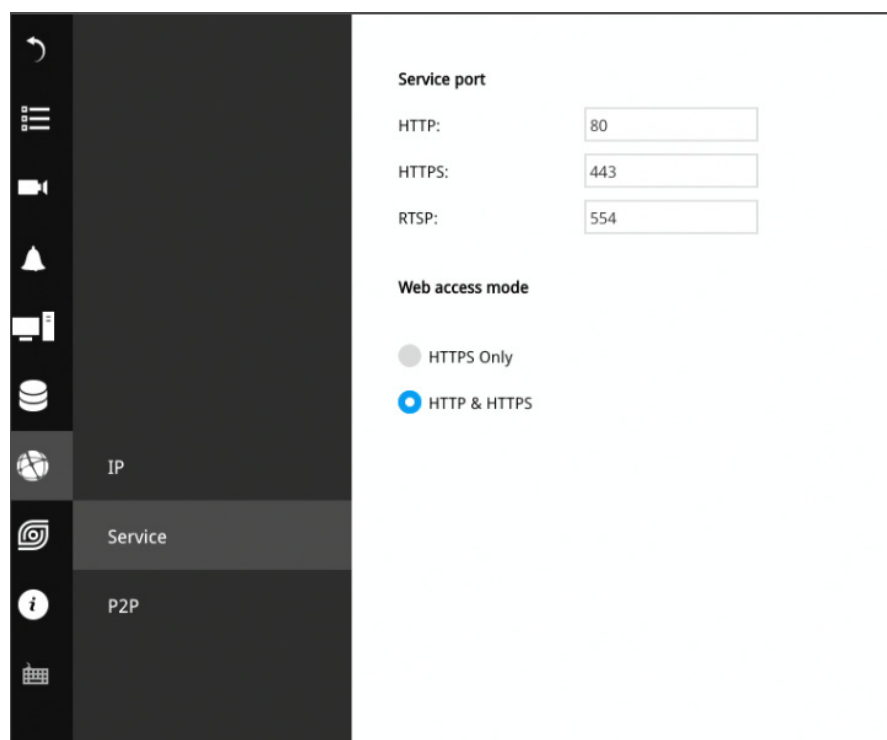
**POE DHCP:** This is the POE network segment.

When finished with the network settings, click **Apply**.

## Settings–Network–Service

Go to  →  → Service.

Figure 6-52 Service



By default, the NVR service and video streaming are accessed via HTTP port 80 and RTSP port 554. You can designate a different port number if the need arises. Usually it is not necessary to change these ports. HTTPS encrypted connection is enabled by default.

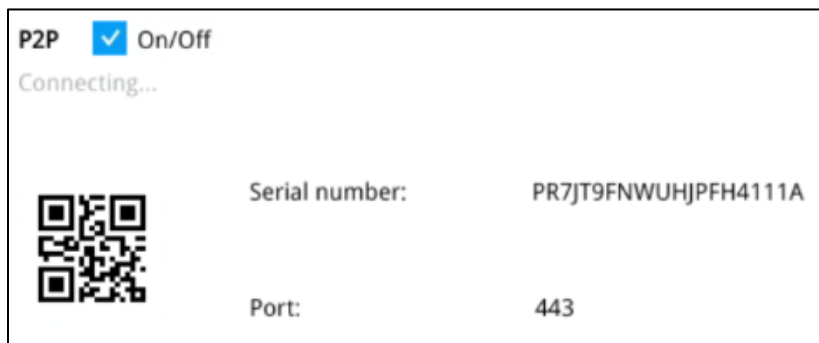
## Settings-Network-P2P

You can easily connect to the unit using a mobile device with the HVMV APP using the P2P screen. To use this option, you will need the HVMV APP downloaded, installed, and have registered/created an account. When the APP is setup, go to **Device Management** → **P2P** and use the camera to view the QR code on the P2P screen. The device's information and connection will automatically be downloaded to the APP and you can now connect to the NVR using your mobile device.

Go to  →  → P2P.

Check the check box to enable this option.

Figure 6-53 P2P Setting



## Setting-MAXPRO Cloud

The MAXPRO Cloud (MPC) enables you to configure, manage and monitor your Video surveillance, access control and Intrusion system through a single user interface from anywhere and anytime.

### Register 30 Series NVR on the MAXPRO Cloud



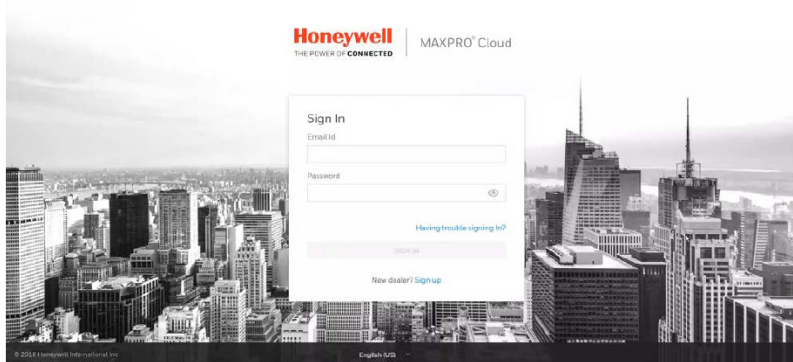
1. Login to the 30 Series NVR and go to  →  → IP to get the MAC ID of the 30 Series NVR.
2. Access the MAXPRO Cloud sign in page (<https://www.mymaxprocloud.com/MPC/Signin>) from your web browser (Google Chrome version 63 or later).
3. Enter the MAXPRO customer user name and password and click **sign in**.

Figure 6-54 MAXPRO Cloud Sign in Page




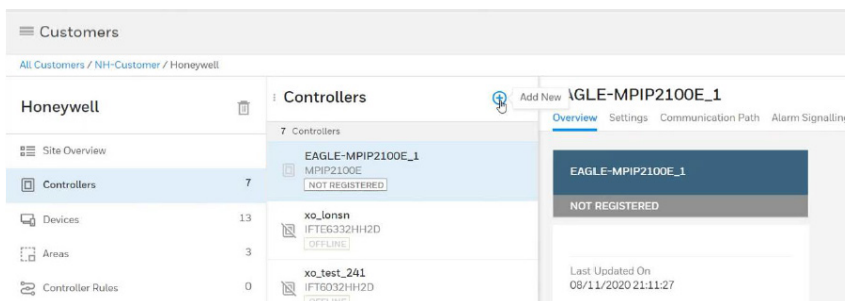
4. Click  and select **Customers**.
5. Select a customer and the site.
6. Click **Controllers** and click **Add New**.

Figure 6-55 Add New Controllers



7. To add the 30 Series NVR, select **Video Recorder** as the **Controller Type**.
8. Enter the **MAC ID** of the 30 Series NVR.
9. Enter the **Controller Name**.
10. Select the TimeZone. This Time Zone will be pushed to the NVR.

Figure 6-56 Add Controller

11. Click **Add Controller**. The success message indicates that the NVR is added successfully.

## Enable MPC Integration on the 30 Series NVR

1. Login to the 30 Series NVR, go to  →  → MAXPRO Cloud.

Figure 6-57 MAXPRO Cloud


**Enable MAXPRO Cloud integration:** Select this checkbox to enable integration with MAXPRO Cloud.

**MAXPRO Cloud registration URL:** The MAXPRO Cloud registration URL.

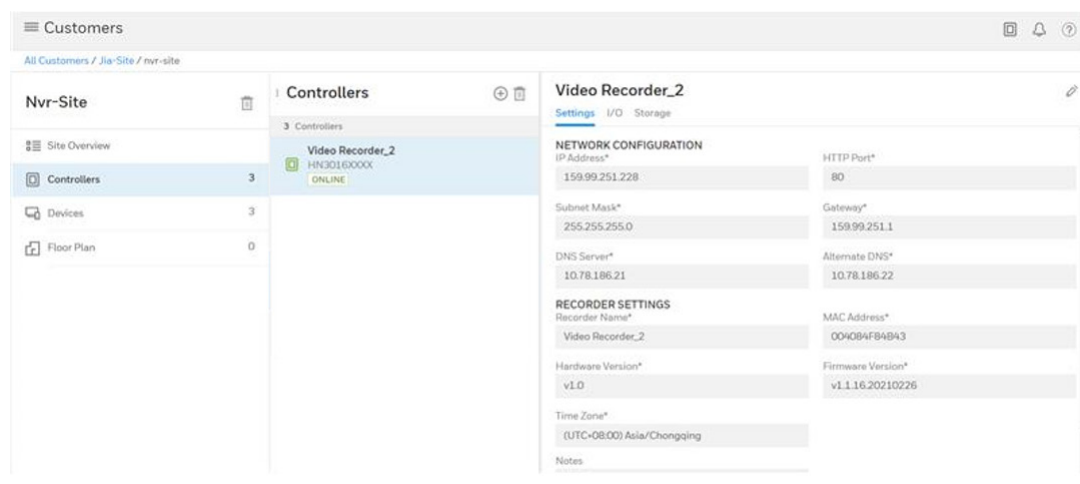
**MAXPRO Cloud port number:** The HTTPS port number for the MAXPRO Cloud web URL.

2. Click **Save**.

## Apply NVR Level Settings

1. Login to MAXPRO Cloud.
2. Click  and select **Customers**.
3. Select a customer and the site.
4. Select a connected device from the MAXPRO Cloud.

**Figure 6-58 4. Select Connected Devices**



**Note** The device status is ONLINE, and the Settings, I/O, and Storage tabs are displayed on the controller page.

**Settings:** The Settings tab displays the device settings. Click the edit icon to enable editing. Most of the device settings do not allow update.

- Check the IP address, port, Subnet Mask, Gateway, DNS server, Firmware version, MAC address, and other details.
- Changing the **Recorder Name** is allowed, but the recorder name setting is applicable only on the MPC side.
- You can add a note in the **Notes** box which is applicable only for the cloud.
- The **Reboot** button can be used to manually reboot the NVR.
- The **Sync Device** button (primarily used for debug purpose only) can be used to synchronize some settings from the NVR to the MPC.

**Note** The Video Format setting is not applicable for 30 Series NVR and is likely to be removed in the future.

**I/O:** The I/O tab displays the device I/O settings. Only the on-board I/O (i.e., USB I/O) is supported and network I/O is not supported. Click the edit icon to enable editing.


- You can change the **Name** of a **Inputs** and can change the **Level** to **NO** (Normally Open) or **NC** (Normally Closed).
- The output behavior is set using **Output**. You can change the **Output** name, **Trigger** source (i.e., the input source triggering the output), and **VMD** (i.e., the camera motion triggering the output).
- You can manually trigger the output by clicking **Test Output** on MPC.

Click **Save** to save the changes on MAXPRO Cloud.

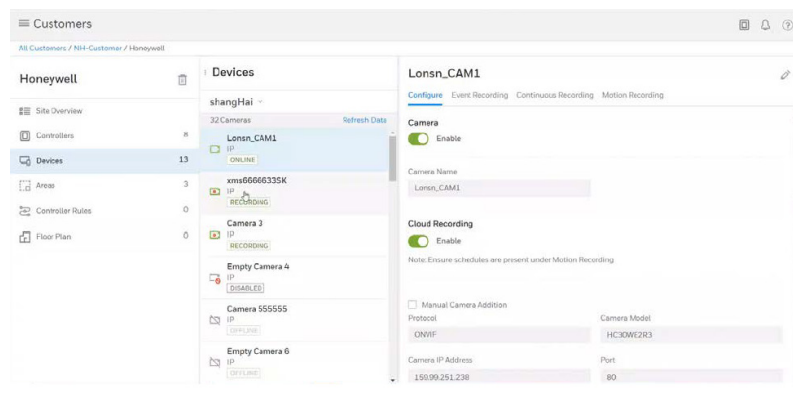
**Storage:** Displays the total capacity of the hard disks and the used space.

5. Click **Save**.

## Apply camera level settings.

1. Click  and select **Customers**.
2. Select the customer and the site.
3. Click **Devices** and select a controller from the drop-down list. The camera list of the 30 Series NVR is displayed.

**Figure 6-59 Devices**



**Note** Cameras with **Disabled** status on MPC is deleted on 30 Series NVR.

4. Select a camera and click edit to change the camera settings. Apply the **Configure** tab settings.

**Note** MPC will change the decode of cameras as H.264 when add cameras with decode H.265.

**Enable:** This setting can be used to enable / disable a camera. If you disable a camera on MPC, the camera is deleted on 30 Series NVR, too.

**Camera Name:** The editable field for the camera name.

**Cloud Recording:** Enable the **Cloud Recording** option to push the camera recordings to MAXPRO Cloud.

There are five types of recordings: **Continuous Recording**, **Event Recording** (alarm input triggered recording), **Motion Recording** (motion triggered recording), **User driven recording** (manual recording from live view on MPC), and **Rule driven recording** (recording triggered by a rule, such as which camera motion will set another camera recording). Apart from continuous recording, clips for the other four types of recordings are pushed to the cloud when this option is enabled.

**Manual Camera Addition:** Select the **Manual Camera Addition** checkbox and change the **Protocol**, **Camera Model**, **Camera IP address**, **Port**, **Username** and **Password** parameters and click **Save** to manually add a camera.

**Discover Cameras:** Click the **Discover Cameras** button to discover cameras. The cameras discovered from the network are displayed in the **Discovered Cameras** drop-down list. You can add the discovered cameras by entering only the username and password as the other parameters are automatically populated.

---

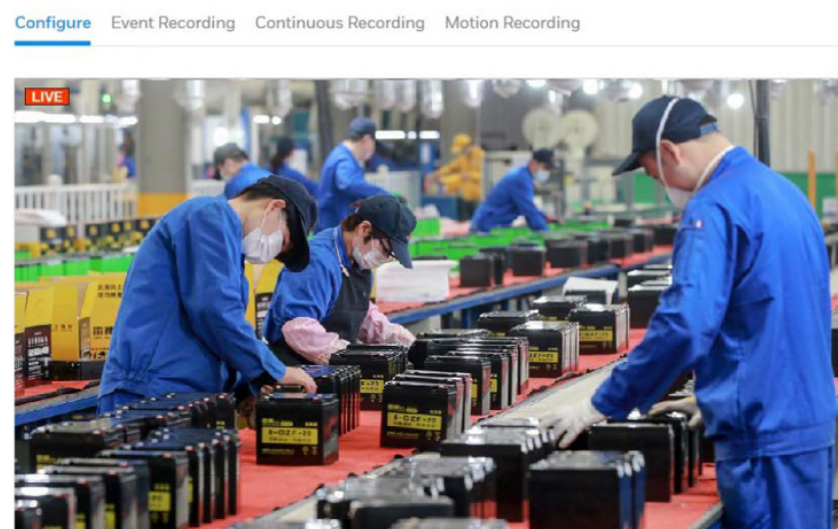
**Note**            The Door Association and Zone Association features do not correspond with 30 Series NVR.

---

5. Click the play button to perform live preview for the camera. Cameras with MFZ function support focus, zoom, and autofocus. Click the stop button (at the bottom-left) to stop the live preview.

**Figure 6-60 Live Preview**

**30NVRCam1**



**Recording Clip Duration:** Set the **Pre Event** and **Post Event** recording duration in seconds for an event trigger, motion trigger, user driven, or rule driven Recording. The clip length will include Pre Event and the Post Event. Pre Event and Post Event can be set to a maximum of

one hour, but the maximum clip length is limited to 90 seconds to save the cloud storage space.

**Recording Settings:** The **Recording Settings** are mapped to the event stream.

---

**Note** The **Camera Resolution** list displays the resolutions supported by the camera.

---

**Live Settings:** The **Live Settings** are mapped to the analytical stream on 30 Series NVR.

---

**Note** MAXPRO Cloud doesn't allow changes to the **Live Settings**.

---


6. Select the **Event Recording** tab for the camera.
7. Click edit and select the alarm inputs that can trigger the recording channel and click **Save**. A maximum of three alarm inputs can be selected.
8. Set the **Motion Recording** and **Continuous Recording** click **Save**. The corresponding camera channel is triggered when the **Event Recording** or the **Motion Recording** is set.

---

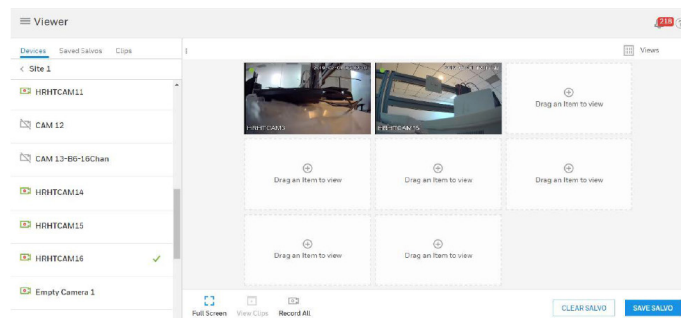
**Note** The **Continuous Recording** setting is applicable for the device and not MPC.

---

## View Recordings on the MAXPRO Cloud

1. Click  and select **Viewer**.
2. Select the **Devices** tab.
3. Select a customer and the site and drag-and-drop up to eight cameras.

**Figure 6-61 Device Tab-Camera List**



4. You can perform user driven recording. Only the channels with live view can be recorded.

**Record All:** to manually record for multiple cameras



**Record:** to manually record for a single camera

5. Select the Clips tab and select a channel.
6. To search the clips:
  - a) Enter the Start Date and the End Date.
  - b) Select the event types which can be Motion, Schedule, Trigger, User Driven, or Rule Driven.
  - c) Select the storage option, which can be On Cloud (clips on MPC), On Site (clips on the device), or Both.
  - d) Click Apply.
7. Drag and drop to view a recorded clip. Up to six clips can playback simultaneously.

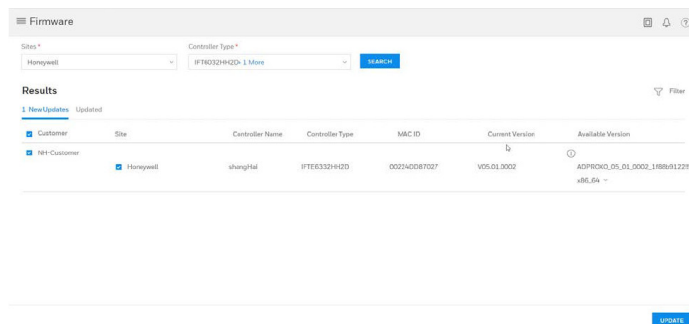
## Upgrade Firmware

MPC allows the user to upgrade the firmware of 30 Series NVR.

To upgrade the firmware

1. Click  and select Firmware.
2. Select the Sites and the Controller Type and click Search.

**Figure 6-62 Search Firmware**




3. Select the check-box under **Site** or **Customer**.
4. Select the firmware version for update from the **Available Version**.
5. Click **Update**.

## Check Alarms

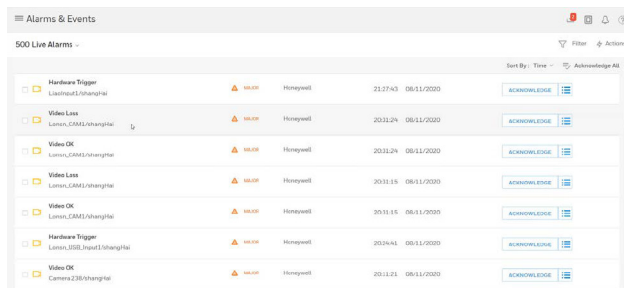
Alarms notify the occurrence of alarms and events selected during setup that occur in any of the connected systems to the operators. Alarms require further action by the operator. Some of the typical alarms are: Input, Motion, Hard disk error, Video Loss, Video OK, Video Disconnect, Camera Disconnect.

Alarms with no severity are events. Every event and alarm is sent as a notification.

To view the Alarms page

1. Click  and select **Alarms**.

**Figure 6-63 Alarm List**



Alarm Type	Status	Entity	Time	Date	Action
Hardware Trigger	Warning	Lenovo_C4M1A8angtai	21:27:43	08/11/2020	ACKNOWLEDGE
Video Loss	Warning	Lenovo_C4M1A8angtai	20:31:29	08/11/2020	ACKNOWLEDGE
Video OK	Warning	Lenovo_C4M1A8angtai	20:31:29	08/11/2020	ACKNOWLEDGE
Video Loss	Warning	Lenovo_C4M1A8angtai	20:31:15	08/11/2020	ACKNOWLEDGE
Video OK	Warning	Lenovo_C4M1A8angtai	20:31:15	08/11/2020	ACKNOWLEDGE
Hardware Trigger	Warning	Lenovo_L58LInpu1A8angtai	20:29:44	08/11/2020	ACKNOWLEDGE
Video OK	Warning	Camera ZIR/A8angtai	20:11:31	08/11/2020	ACKNOWLEDGE

The upper-right corner of the Alarms tab displays the following options:

**Filter:** The filter option enables to filter through the list of alarms based on:

- **Entities:** Controllers, Cameras, Doors, and Rules.
- **Time:** View Archived Events, Today, Yesterday, and Custom.
- **Events:** Access, Video and Intrusion.
- **Sites:** You can select and search the site.

**Actions:** Enables you to perform the following for the alarms that appear in the **Alarm** window.

- **Freeze Alarm Stream:** Stop receiving new or unacknowledged alarms in the new window. You can click this command again to start receiving the alarms. This feature is useful when the Alarm window contains many unacknowledged alarms and it becomes difficult to manage them. You can stop receiving the alarms momentarily and start receiving again when needed.
- **Acknowledge:** Acknowledge the selected alarm. It enables you to acknowledge an alarm to accept that the necessary response action is being taken.
- **Archive:** Clear the alarms when they are acknowledged.

# 7 Management over a Web Console

This chapter contains the following sections:

- [Before Getting Started](#) on page 75.
- [Login](#) on page 75.
- [Live View Screen](#) on page 76.
- [Search Recording Clips Screen](#) on page 83.
- [Settings Screen](#) on page 86.

There are two different interfaces on the system:

- One is connecting mouse and keyboard, and an HDMI cable to a TV screen or monitor. The local management thus made is described in Section One of this manual.
- The other is accessed through the Ethernet connection. Management via a web console will be described in this chapter of this manual.

---

**Note** When accessed over the network, the total streaming throughput is 128Mbps.

---

Figure 7-1 WAN/LAN Connection (HN300401xx)

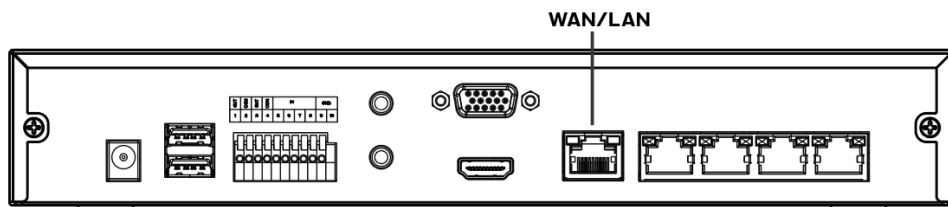
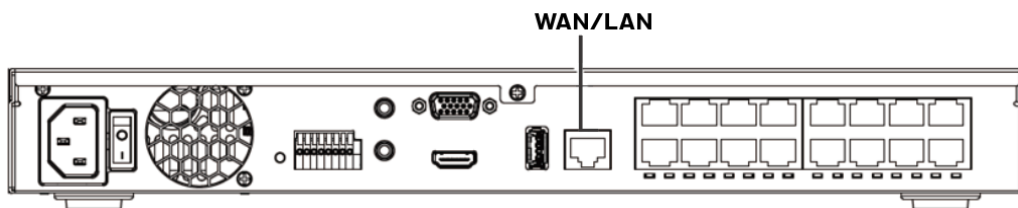


Figure 7-2 (HN300802xx/HN301602xx)



## Before Getting Started

- Before operating the NVR, make sure you have properly installed hard drives and configured the storage volumes. Otherwise, you will not be able to operate some of the system's functionality.
- When you log in to the Liveview or Playback interface to stream a live or recorded video, install the ActiveX plug-ins. If it does not prompt when you log in, install plug-ins when you try to playback a recorded video. You may then need to re-start the IE browser console.

---

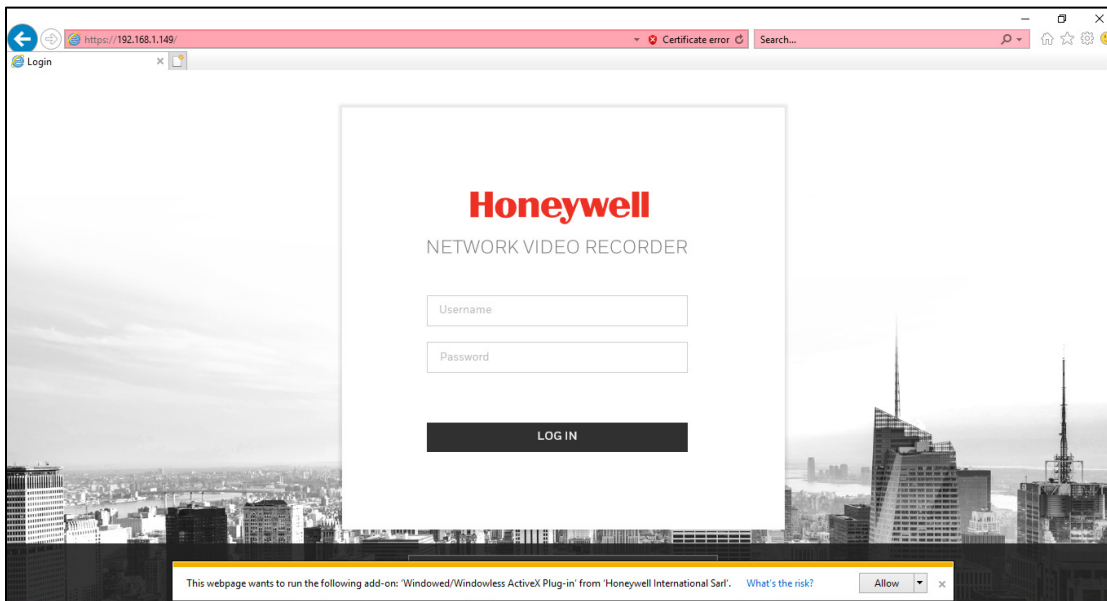
### Note

- Chrome doesn't require plug-ins.
  - Chrome only supports streaming with H.264.
- 

## Login

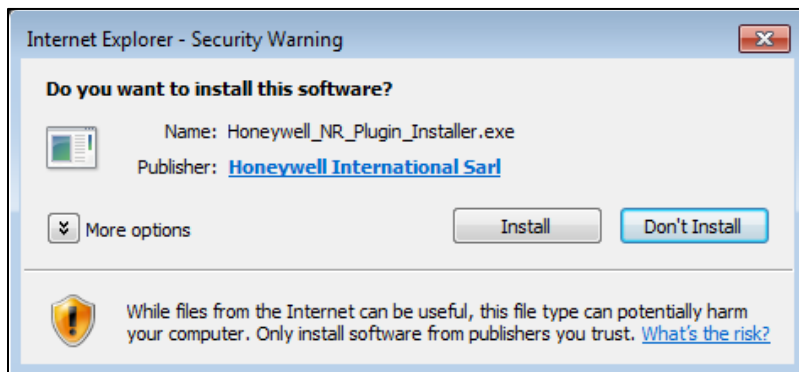
6. Enter the IP address of NVR in the address field of a web browser and click search, the following screen is displayed:

Figure 7-3 Web Client Log in



7. Click **Allow** in the ActiveX plug-ins window at the bottom of the screen and the following window is displayed:

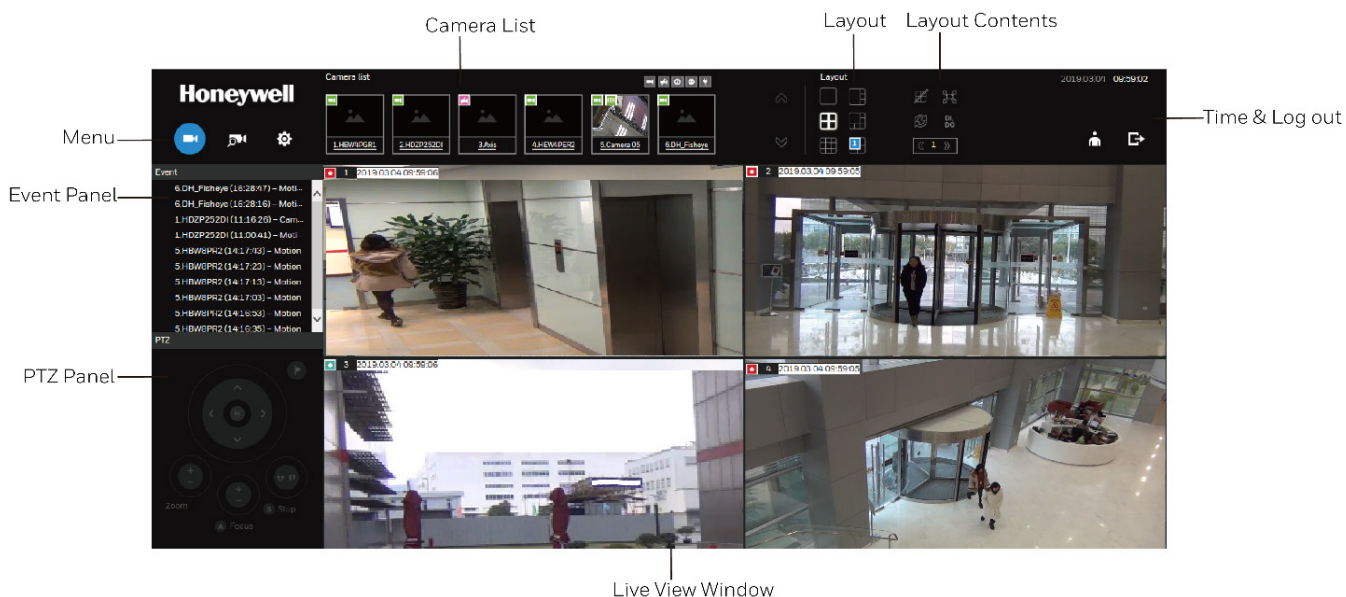
Figure 7-4 Plugin Install



8. Click **Install** and wait till the login window shows again. For the first login, the default username is “admin” and the password is “1234”.
9. Enter the username and the password and click **LOG IN** to enter the live view screen.

## Live View Screen

Figure 7-5 Live View Screen



Once you log in, the system defaults to the live view screen, which provides access to other configuration entry. The screen elements are described as follows:

Table 7-1 Web Live View Screen

Name	Description
Camera List	Provides a glimpse of all cameras inserted into your configuration. Basic information is also provided along with a screenshot.

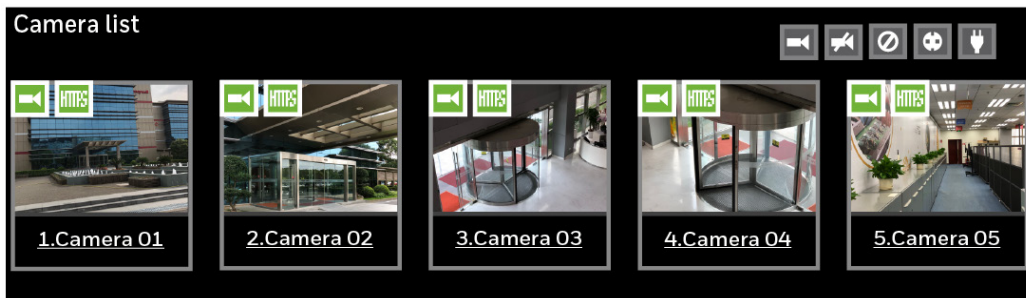
<b>Layout</b>	Provides access to various layouts.
<b>Layout contents</b>	Provides functions to extend, rotate, and redo the layout. System Alarm In /Alarm Out are also shown in here.
<b>Time &amp; Log out</b>	Shows the time and logout function.
<b>Live View Window</b>	Displays video streams from one or multiple cameras. Snapshot, streaming, bookmark, and audio control functions are also available on individual view cells.
<b>PTZ Panel</b>	Exerts Pan/Tilt control on a selected view cell if the camera comes with mechanical PTZ mechanism.
<b>Event panel</b>	Reports events transmitted via cameras' Alarm In connections or those by the Motion Detection, Tampering, etc.

## Camera List

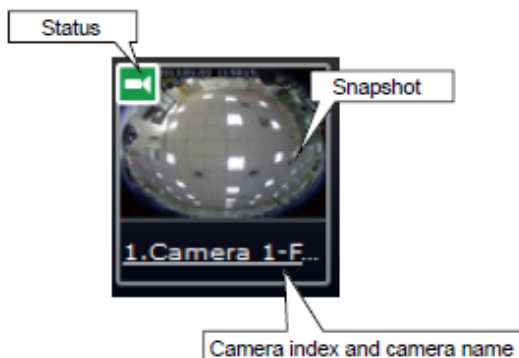
The camera list displays the recruited cameras by the sequential numbering order you configured in the System Settings utility.

To arrange a view window layout, click and drag a camera from the camera list to a view window.










Figure 7-6 Camera List








Depending on the size and screen resolution of your monitor, the snapshots of 6 cameras are displayed in this panel. If you logged in using a credential of a limited access, you may only see cameras that you can access instead of all the cameras.



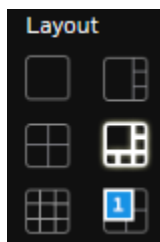
- **Snapshot:** the camera's image snapshot is replenished every 5 minutes. If a camera is disconnected, the last image taken will be used to represent a camera.
- **Camera index & Camera name:** Placing the mouse cursor on top of a camera text displays the camera index number and the camera name. Click on the camera index to display the information box.
- **Status:**

	<b>Online:</b> the online status can be accompanied by the Alarm In/Alarm Out icon   .
	<b>Offline:</b> camera is disconnected.
	An unconfigured camera instance.
	Alarm input is triggered.
	Connected and recording video to system storage.
	Connected with live streaming.
	Disconnected or trying to establish a connection.

## Layout




By default, 5 typical layouts are provided for the user. They include:  1x1,  2x2,  3x3,  1V+3, and  1M+5. System default is the 2x2 layout. Cameras that do not fit into the first page of a layout, say, a 3x3 layout, will be displayed on the succeeding layout pages.

**Figure 7-7 Layout**



**Note** The layouts for 4/8/16 CHs NVR are different. Please refer to the actual NVR you used.

Each functional button on the screen is activated by a mouse hover. For example, the below states designate user's operation on a button:

-  : not selected.
-  : moused over and is ready for selection.
-  : selected and is taking effects.






There are another 4 user layouts that can be individually configured. An administrator can insert camera views into these layouts and save the configuration. These user layouts can be seen by all users.

If you click the Rotate button before the configuration changes can be saved, your configuration changes will be lost.

## Layout Contents

A few functional buttons are available on the Layout contents page.


**Table 7-2 Layout Contents**

	Clears all view cells on the current layout.
	Full view: extends the view cells on the current layout to the full of the screen.
	Exit full view. It is showed at the left side of the full view window.
	Rotate: the rotate function lets system display successive layout pages by the intervals of 10 seconds. The layout page that does not contain camera views will be skipped.
	Click to display the NVR's Alarm In/Alarm Out statuses.

## Time & Log out

The system date and time refers to the date and time kept on the NVR system's real time clock.

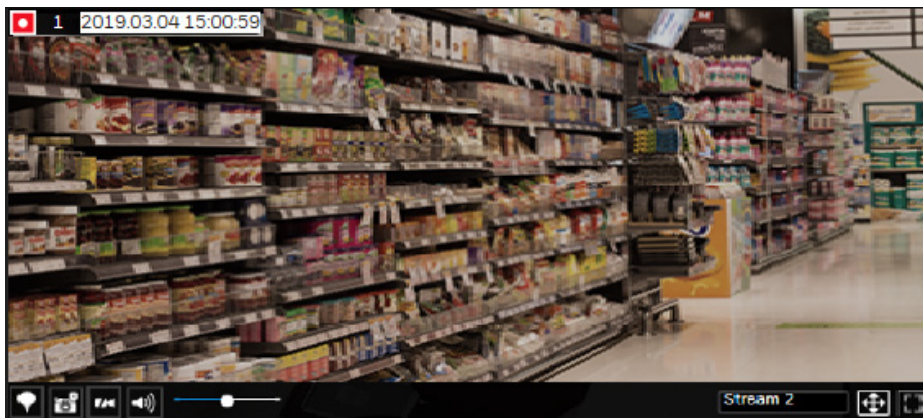
Due to the limited space for the user name, user name may be partially displayed until you hover your mouse cursor.

To Log out, click .



## Live View Window

Figure 7-8 Live View Window



### Information Bar

Figure 7-9 Information Bar

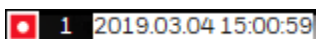


Table 7-3 Information Bar

	Connected with live streaming; a single click on this icon can trigger a manual recording.
	Connected and recording video to system storage.
	Disconnected or trying to establish a connection.
15:00:59	Video time
2019.03.04	Date









### Tool Bar

Figure 7-10 Tool Bar



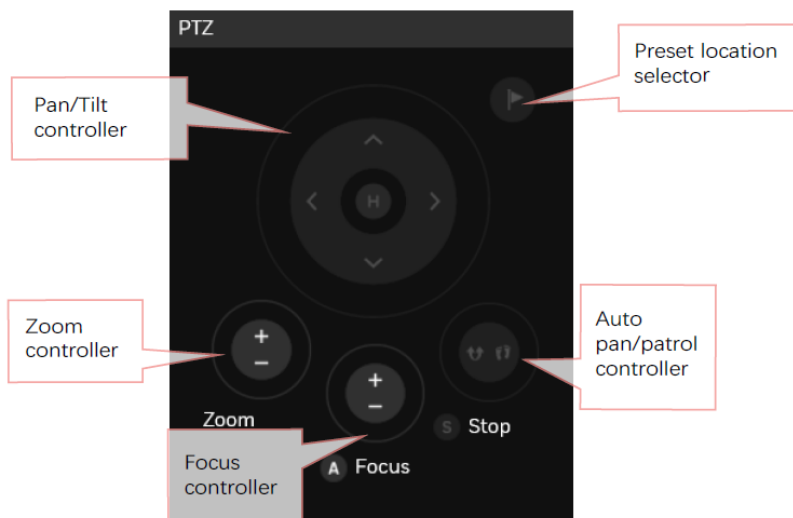
Table 7-4 Tool Bar

	Add a Bookmark (that saves a short description and a one-minute footage from the current feed).
	Take a snapshot.
	Remove camera from the view cell.
	Mute (if there is audio input from the camera.)

	Unmute
	Stream selector.
	Fit screen with ratio.
	Maximize the size of current view cell.
	Restore the size of current view cell.
	Disable digital zoom.
	Enable digital zoom.
	Volume controller.

## PTZ Panel

Figure 7-11 PTZ Panel



The PTZ panel takes effect for cameras that come with mechanical PTZ functions. It does not support digital PTZ functions. To utilize its functions, select a view cell populated by a PTZ camera, such as a speed dome.


Depending on the individual functions that come with PTZ cameras, some functions will not be available for every camera. For example, the zoom controller will not apply for a PTZ camera that comes without a mechanized zoom module.

## Event Panel

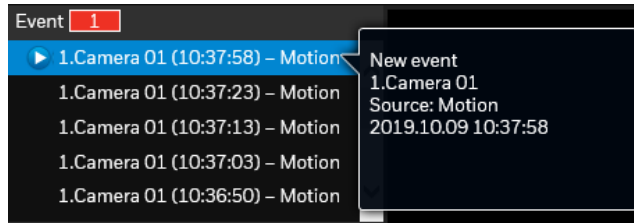
The event panel keeps up to 200 events and displays the latest 10 event entries with the latest alarm on top of the list. Older events will be erased if the number exceeds 200.


It is polled every 10 seconds. A mouse hover on an alarm entry displays full information of the event.

Note that multiple alarms can be triggered by one incident. See [Setting-Event-Event](#) on page 44 for how to configure the event settings.

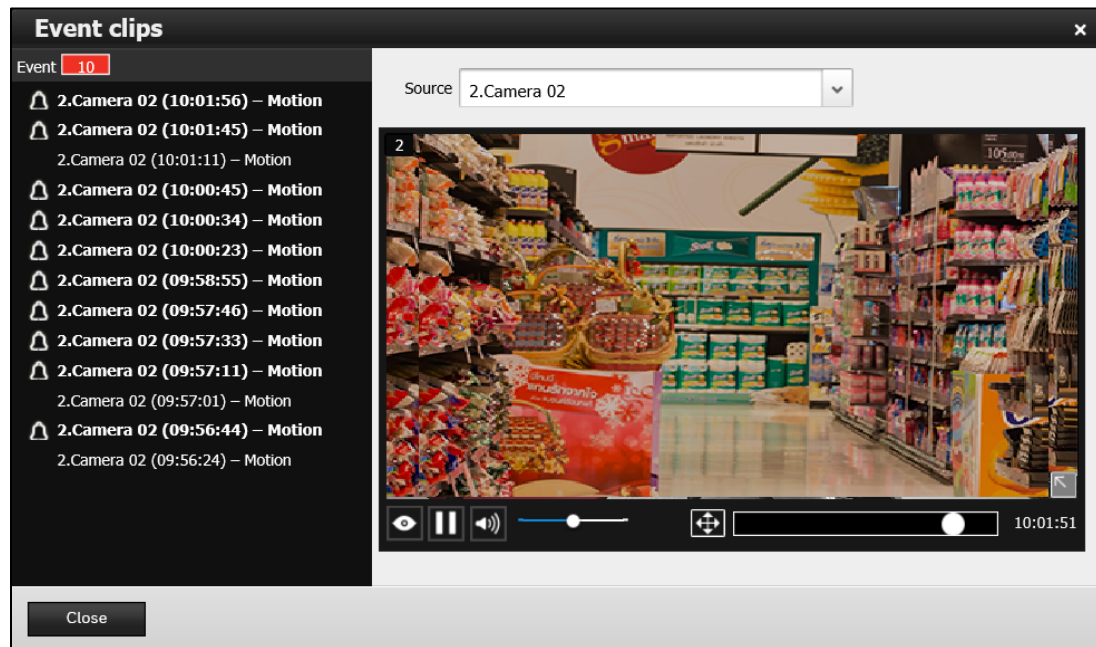
If an event is configured with a recording action, there will be a play button  to the left of the alarm message.





**Figure 7-12 Event Panel 2**



Click  and the event playback window will begin playback of a footage taken 10 seconds before the occurrence of an alarm. The playback of an alarm-triggered recording will normally last for one minute. If, however, you configured a shorter pre- and post-alarm recording time, your alarm recording may be slightly shorter. The default for pre- and post-alarm buffer time are 5 seconds and 20 seconds.

**Figure 7-13 Event Clips**



-  View live video: displays the live view streaming instead of the alarm recording.
-  Begin the event playback.
-  Pause the current playback.
-  Mute or unmute the audio with the current playback. Drag the controller to change the audio volume level.



Fit screen with ratio.



Click to enable the digital zoom function.

## Search Recording Clips Screen


Click  on [Figure 7-3](#) and the following screen is displayed:

Figure 7-14 Search Recording Clips Screen

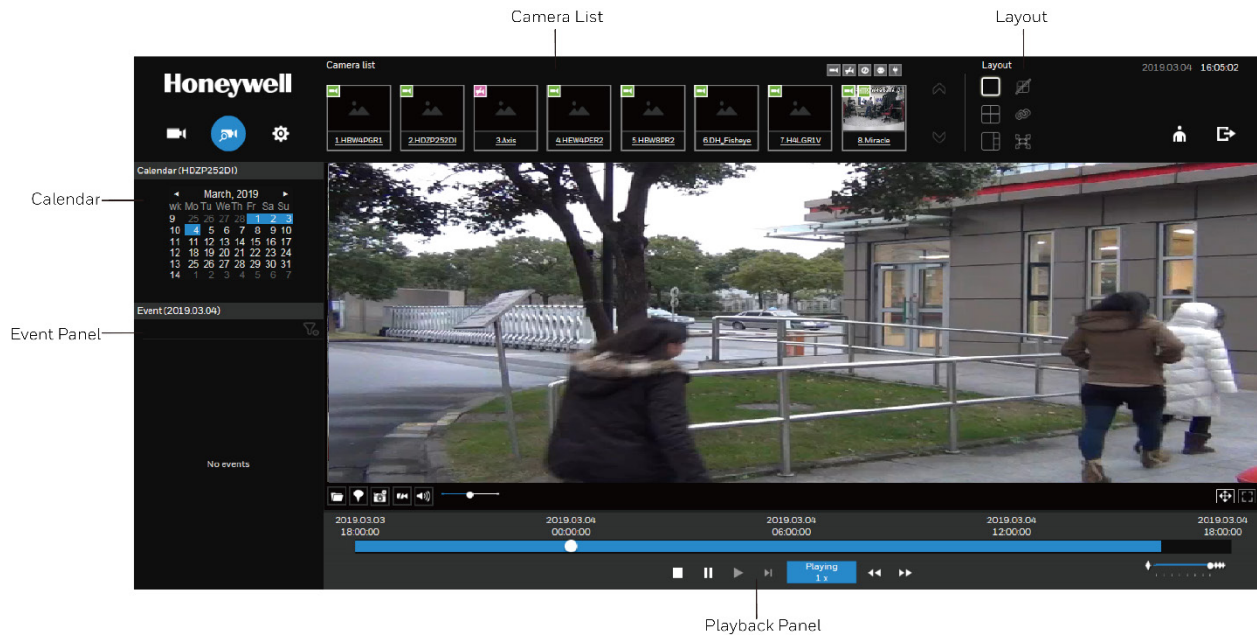


Table 7-5 Search Recording Clips Screen

Name	Description
Camera List	Provides a glimpse of all cameras that have recorded data. Basic information is also provided along with a screenshot.
Layout	Provides functions to extend, rotate, redo the layout, and the synchronous playback.
Playback panel	Displays the playback functions. Snapshot, bookmark, and export functions are also available on individual view cells.
Event panel	Reports events transmitted via cameras' DI connections or those by the Motion Detection, etc.
Calendar	Shows when the recording took place, and thus enables users to quickly locate a specific part of recording in history.

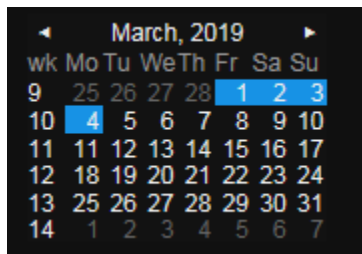
## Camera List

The camera list displays the 8 added cameras by the sequential numbering order you configured in the System Settings window. The elements in the Camera list on a Search recording clips window are identical to those on a Liveview window.

To begin playback and search for past recordings:

1. Double-click on a camera in the camera list. The Calendar panel will display the days video recording actually took place. And those days will be highlighted by a blue background.

**Figure 7-15 Calendar**

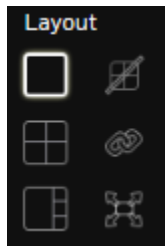


2. Click the date that marked in blue.





## Layout

3 types of layouts are provided for the Search recording clips window: 1x1, 2x2, and 1+3. Users can simultaneously playback up to 4 recorded videos.

**Figure 7-16 Layout**



**Table 7-6 Layout**

	Clears layout content.
	Starts or stops the Synchronous playback.
	Full view: extends the view cells on the current layout to the full of the screen.
	Exit full view. It is showed at the left side of the full view window.

## Playback Panel

Figure 7-17 Playback Panel

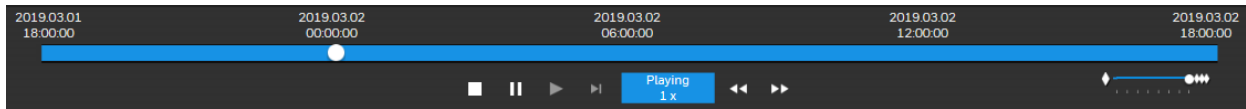





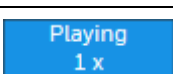
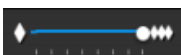

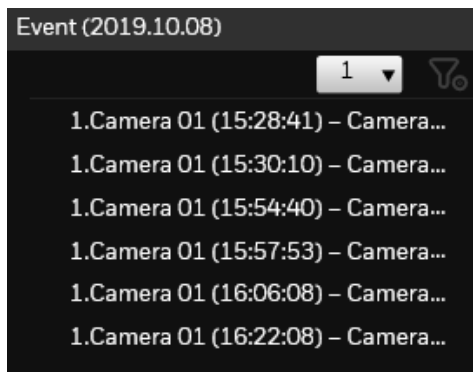


Table 7-7 Playback Panel

	Pause
	Play. This button is available after you manually pause a playback.
	Stop the current playback.
	Speed down by 1/2. The slowest speed is 1/8.
	Speed up. Increases the playback speed, to 2x, 4x, 8x, 16x, and then to a maximum of 32x.
	Display the current playback status, such as Playing, Pause, play speed, or Stop.
	Timeline zoomer. Use the zoomer to zoom in for more precise skimming. You can use the timeline zoomer to scale down the span of time. For example, if the time span is reduced to 1 hour, then each section on the time line represents 15 minutes of recording. The total time span of a timeline starts from the minimal of 4 minutes, 20 minutes, 40 minutes, 1 hour, and up to a maximum of 24 hours.
	Timeline slider thumb. Click and drag this thumb button to move along and reach a specific point in time. A click on the time line will also work.
<b>Note</b>	In the Synchronous play mode, a change to the zoomer will be reflected by all synchronously playing view cells.

## Event Panel

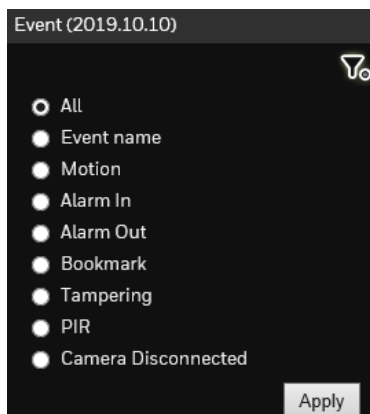
The event panel displays the events or bookmarks recorded by the day of recording. Two additional buttons are available: **Page selector** and **Event filter**. See [Creating an Event](#) on page 44 for how to create an event.

**Figure 7-18 Event Panel**

- A playback button will be available with an event-triggered recording. The event panel in the Playback window also supports the List mode and Icon mode that are similar to that in the Liveview window.
- There can be numerous alarms occurring in a day. Use the **page selector** to display different pages of event entries. Up to 200 entries can appear on one page. Note that the new events that occurred seconds or minutes ago may not be instantaneously listed on the page.

### Event Filter

Use the event filter to find out specific events. Use the check circles below to narrow down your search criteria by event name or event type by Motion detection, Alarm input, Alarm output, Tampering, PIR, or those manually marked down as Bookmarks.

**Figure 7-19 Event Filter**

## Settings Screen

The settings screen is identical to those found in the local settings. See [Settings](#) on page 29 for more information.

### Honeywell Building Technologies – Security Americas (Head Office)

Honeywell Commercial Security  
715 Peachtree St. NE  
Atlanta, GA 30308  
[www.security.honeywell.com/](http://www.security.honeywell.com/)  
Tel: +1 800 323 4576

### Honeywell Building Technologies – Security Mexico

Mexico: Av. Santa Fe 94, Torre A, Piso 1, Col. Zedec,  
CP 0121, CDMX, Mexico.  
Colombia: Edificio Punto 99, Carrera 11a.  
98-50, Piso 7, Bogota, Colombia.  
Tel: 01.800.083.59.25

### Honeywell Colombia SAS

Carrera 11A # 98-50, Edificio Punto 99, Piso 7  
Bogotá DC, Colombia

### Honeywell Building Technologies – Security Middle East/N. Africa

Emaar Business Park, Building No. 2, Sheikh Zayed Road  
P.O. Box 232362  
Dubai, United Arab Emirates  
security\_meta@honeywell.com  
[www.security.honeywell.com/me](http://www.security.honeywell.com/me)  
Tel: +971 4 450 5800

### Honeywell Building Technologies – Security Europe/South Africa

140 Waterside Road, Hamilton Industrial Park  
Leicester, LE5 1TN, United Kingdom  
[www.security.honeywell.com/uk](http://www.security.honeywell.com/uk)  
Tel: +44 (0) 1928 378005

### Honeywell Building Technologies – Security Northern Europe

Stationsplein Z-W 961, 1117 CE Schiphol-Oost, Netherlands  
[www.security.honeywell.com/nl](http://www.security.honeywell.com/nl)  
Tel: +31 (0) 299 410 200

### Honeywell Building Technologies – Security Deutschland

Johannes-Mauthe-Straße 14, 72458 Albstadt, Germany  
[www.security.honeywell.de](http://www.security.honeywell.de)  
Tel: +49 (0) 7431 801-0

### Honeywell Building Technologies – Security France

Immeuble Lavoisier  
Parc de Haute Technologie  
3-7 rue Georges Besse  
92160 Antony, France  
[www.security.honeywell.com/fr](http://www.security.honeywell.com/fr)  
Tel: +33 (0) 1 40 96 20 50

### Honeywell Building Technologies – Security Italia SpA

Via Achille Grandi 22, 20097 San Donato Milanese (MI), Italy  
[www.security.honeywell.com/it](http://www.security.honeywell.com/it)

### Honeywell Building Technologies – Security España

Josefa Valcárcel, 24  
28027 – Madrid, España  
[www.security.honeywell.com/es](http://www.security.honeywell.com/es)  
Tel: +34 902 667 800

### Honeywell Building Technologies – Security Россия и СНГ

121059 Moscow,  
Ul, Kiev 7 Russia  
[www.security.honeywell.com/ru](http://www.security.honeywell.com/ru)  
Tel: +7 (495) 797-93-71

### Honeywell Building Technologies – Security Asia Pacific

Building #1, 555 Huanke Road,  
Zhang Jiang Hi-Tech Park Pudong New Area,  
Shanghai, 201203, China  
[www.asia.security.honeywell.com](http://www.asia.security.honeywell.com)  
Tel: 400 840 2233

### Honeywell Building Technologies – Security and Fire (ASEAN)

Honeywell International Sdn Bhd  
Level 25, UOA Corp Tower, Lobby B  
Avenue 10, The Vertical, Bangsar South City  
59200, Kuala Lumpur, Malaysia  
Visit Partner Connect: [www.partnerconnect.honeywell.com](http://www.partnerconnect.honeywell.com)  
Email: buildings.asean@honeywell.com  
Technical support (Small & Medium Business):

Vietnam: +84 4 4458 3369  
Thailand: +66 2 0182439 Indonesia: +62 21 2188 9000  
Malaysia: +60 3 7624 1530  
Singapore: +65 3158 6830  
Philippines: +63 2 231 3380

### Honeywell Home and Building Technologies (India)

HBT India Buildings  
Unitech Trade Centre, 5th Floor,  
Sector – 43, Block C, Sushant Lok Phase – 1,  
Gurgaon – 122002, Haryana, India  
Visit Partner Connect: [www.partnerconnect.honeywell.com](http://www.partnerconnect.honeywell.com)  
Email: HBT-IndiaBuildings@honeywell.com  
Toll Free No: 1-800-103-0339  
Tel: +91 124 4975000

### Honeywell Building Technologies – Security and Fire (Korea)

Honeywell Co., Ltd. (Korea)  
5F SangAm IT Tower,  
434, Worldcup Buk-ro, Mapo-gu,  
Seoul 03922, Korea  
Visit: <http://www.honeywell.com>  
Email: info.security@honeywell.com  
Customer support: HSG-CS-KR@honeywell.com; +82 1522-8779  
Tel: +82-2-799-6114

### Honeywell Building Technologies – Security & Fire (Pacific)

Honeywell Ltd  
9 Columbia Way  
BAULKHAM HILLS NSW 2153  
Visit: [www.security.honeywell.com/](http://www.security.honeywell.com/)  
Email: hsf.comms.pacific@Honeywell.com  
Technical support:  
Australia: 1 300 220 345  
New Zealand: +64 9 623 5050

# Honeywell

[www.security.honeywell.com](http://www.security.honeywell.com)  
+1 800 323 4576 (North America only)

<https://www.honeywell.com/ss/techsupp/index.html>

Document 800-25988V1 – Rev B– 06/2021