

AVR **HN Series**

NVR USER MANUAL

Please read this manual carefully for correct use of the product and preserve it for reference purposes.

Notes on Safety

- Please read this user manual carefully to ensure that you can use the device correctly and safely.
- There may be several technically incorrect places or printing errors in this manual. The updates will be added into the new version of this manual. The contents of this manual are subject to change without notice.
- This device should be operated only from the type of power source indicated on the marking label. The voltage of the power must be verified before using the same. Kindly remove the cables from the power source if the device is not to be used for a long period of time.
- Do not install this device near any heat sources such as radiators, heat registers, stoves or other devices that produce heat.
- Do not install this device near water. Clean only with a dry cloth.
- Do not block any ventilation openings and ensure proper ventilation around the machine.
- Do not power off the device at normal recording condition.
- This machine is for indoor use only. Do not expose the machine in rain or moist environment. In case any solid or liquid get inside the machine's case, please turn off the device immediately and get it checked by a qualified technician.
- Do not try to repair the device by yourself without technical aid or approval.
- When this product is in use, the relevant contents of Microsoft, Apple and Google will be involved in. The pictures and screenshots in this manual are only used to explain the usage of our product. The ownerships of trademarks, logos and other intellectual properties related to Microsoft, Apple and Google shall belong to the above-mentioned companies.
- This manual is suitable for many models. All examples and pictures used in the manual are from one of the models for reference purpose.

Table of Contents

Contents

1	Introduction.....	1
	1.1 Summary	1
	1.2 Features	1
	1.3 Front Panel Descriptions	5
	1.4 Rear Panel Descriptions	6
	1.5 Connections.....	11
2	Basic Operation Guide	13
	2.1 Startup & Shutdown	13
	2.1.1 Startup	13
	2.1.2 Shutdown	13
	2.2 Remote Controller	13
	2.3 Mouse Control	16
	2.4 Text-input Instruction	17
	2.5 Common Button Operation	17
3	Wizard & Main Interface	18
	3.1 Startup Wizard.....	18
	3.2 Main Interface	24
	3.2.1 Main Interface Introduction	24
	3.2.2 Setup Panel	27
	3.2.3 Main Functions	28
4	Camera Management	30
	4.1 Add/Edit Camera	30
	4.1.1 Add Camera	30
	4.1.2 Edit Camera	33
	4.2 Add/Edit Camera Group	35
	4.2.1 Add Camera Group	35
	4.2.2 Edit Camera Group	36
	4.2.3 IP Planning	36
5	Live Preview Introduction	38
	5.1 Preview Interface Introduction	38
	5.2 Preview Mode	40
	5.2.1 Preview By Display Mode	40
	5.2.2 Quick Sequence View	42
	5.2.3 Camera Group View In Sequence	43
	5.2.4 Scheme View In Sequence	44
	5.3 POS Settings	46
	5.4 Preview Image Configuration	48
	5.4.1 OSD Settings	48

	5.4.2 Image Settings	49
	5.4.3 Mask Settings	49
	5.4.4 Fisheye Settings	50
	5.4.5 Image Adjustment	50
6	PTZ	53
	6.1 PTZ Control Interface Introduction	53
	6.2 Preset Setting	56
	6.3 Cruise Setting	57
	6.4 Cruise Group Setting	59
	6.5 Trace Setting	59
	6.6 Task Setting	60
7	Record & Disk Management	62
	7.1 Record Configuration	62
	7.1.1 Mode Configuration	62
	7.1.2 Advanced Configuration	64
	7.2 Encode Parameters Setting	65
	7.3 Schedule Setting	66
	7.3.1 Add Schedule	66
	7.3.2 Record Schedule Configuration	68
	7.4 Record Mode	69
	7.4.1 Manual Recording	69
	7.4.2 Timing Recording	69
	7.4.3 Motion Based Recording	69
	7.4.4 Sensor Based Recording	70
	7.4.5 Intelligence Recording	70
	7.5 Disk	70
	7.5.1 Disk Management	70
	7.5.2 Storage Mode Configuration	71
	7.5.3 View Disk and S.M.A.R.T. Information	72
8	Playback & Backup	73
	8.1 Instant Playback	73
	8.2 Playback Interface Introduction	73
	8.3 Smart Playback	77
	8.3.1 Smart Playback Setting	77
	8.3.2 Smart Playback Based on Motion Detection	77
	8.3.3 Smart Playback by Face Search	79
	8.3.4 Smart Playback by License Plate	80
	8.4 Record Search, Playback & Backup	81
	8.4.1 Search, Playback & Backup by Time-sliced Image	81
	8.4.2 Smart Search	84
	8.4.3 Search, Playback & Backup by Time	85
	8.4.4 Search, Playback & Backup by Event	85
	8.4.5 Search & Playback by Tag	86
	8.4.6 Image Management	87
	8.4.7 View Backup Status	87
9	AI Event Management	88
	9.1 Face Recognition	88

9.1.1	Face Detection Settings	88
9.1.2	Face Database Management	91
9.1.3	Face Recognition Settings	93
9.2	License Plate Recognition	95
9.2.1	License Plate Detection Settings	95
9.2.2	Plate Database Management	96
9.2.3	License Plate Recognition Settings	97
9.3	Tripwire	98
9.4	Intrusion Detection	100
9.5	Abandoned/Missing Object Detection	101
9.6	Crowd Density Detection	102
9.7	Line Crossing Counting	103
9.8	Exception Detection	104
10	Intelligent Analytics	106
10.1	Target Detection View	106
10.1.1	Human Body/Vehicle Detection View	106
10.1.2	Face Detection/Match View	107
10.1.3	License Plate Detection/Recognition View	111
10.2	Smart Search	112
10.2.1	Face Search	112
10.2.2	Track Playback	117
10.2.3	Face Search by Snapshot	119
10.2.4	Human Body Search	120
10.2.5	Vehicle Search	121
10.2.6	Combination Search	122
10.3	View Statistical Information	122
10.4	Face Attendance	123
10.5	Face Check-In	125
11	General Event Management	127
11.1	Sensor Alarm	127
11.2	Motion Alarm	128
11.2.1	Motion Configuration	128
11.2.2	Motion Alarm Handling Configuration	129
11.3	Combination Alarm	130
11.4	Exception Alarm	131
11.4.1	IPC Offline Settings.....	131
11.4.2	Exception Alarm Settings	132
11.5	Alarm Event Notification	132
11.5.1	Alarm-out	132
11.5.2	E-mail	133
11.5.3	Display	133
11.5.4	Buzzer.....	133
11.5.5	Push Message	133
11.5.6	Audio	134
11.5.7	Light	136
11.5.8	Alarm Server	136
11.6	Manual Alarm	136

11.7	View Alarm Status	137
12	Account & Permission Management	138
12.1	Account Management	138
12.1.1	Add User.....	139
12.1.2	Edit User.....	139
12.2	User Login & Logout	141
12.3	Permission Management	141
12.3.1	Add Permission Group	141
12.3.2	Edit Permission Group	143
12.4	Black and White List	143
12.5	Preview On Logout	144
12.6	Network Security	145
12.7	Password Security	145
12.8	View Online User	145
13	Device Management	146
13.1	Network Configuration	146
13.1.1	TCP/IP Configuration	146
13.1.2	Port Configuration	149
13.1.3	PPPoE Configuration	152
13.1.4	DDNS Configuration	153
13.1.5	E-mail Configuration	155
13.1.6	UPnP Configuration	156
13.1.7	802.1X	157
13.1.8	NAT Configuration	158
13.1.9	FTP Configuration	158
13.1.10	Platform Access	158
13.1.11	SNMP	159
13.1.12	View Network Status	160
13.2	Basic Configuration.....	160
13.2.1	Common Configuration	160
13.2.2	Date and Time Configuration	161
13.2.3	Recorder OSD Settings.....	162
13.3	Factory Default.....	162
13.4	Device Software Upgrade	163
13.5	Backup and Restore	164
13.6	Restart Automatically	164
13.7	View Log	165
13.8	View System Information	165
14	Remote Surveillance	166
14.1	Mobile Client Surveillance	166
14.2	Web LAN Access	166
14.3	Web WAN Access.....	167
14.4	Web Remote Control	169
14.4.1	Remote Preview	169
14.4.2	Remote Playback	172
14.4.3	Remote Search and Backup	173
14.4.4	Intelligent Analysis	174
14.4.5	Remote Configuration	174

Appendix A FAQ	175
Appendix B Calculate Recording Capacity	181
Appendix C Compatible Device List	183
Appendix D Communication Port List	184
Appendix E Personal Data Collection Description	185
Appendix F Default Account List	186
Appendix G Command List	187

1 Introduction

1.1 Summary

Based on the most advanced SOC technology and embedded system in the field, this series of the NVR adopt the new designed human interface and support the smart management of the IP camera and the record search of slice. This series of the NVR which are powerful and easy to use are provided with excellent image quality and stable system. They are centralized monitoring management products with high performance and high quality specially designed for network video monitoring field.

This series of the NVR can be widely used to security system of banks at home and abroad, schools, intelligent mansions, traffic, environmental protection, supermarkets, petrol service stations, residential quarters and factories and so on.

1.2 Features

Basic Functions

- Support network device access including IP camera/dome and the third party IP cameras
- Some NVRs support the latest H.265 video coding stream and a mixture input of H.265 and H.264 IP cameras
- Support standard ONVIF protocol
- Support dual stream recording of each camera
- Support IP cameras to be added quickly or manually
- Support batch or single configuration of the cameras' OSD, video parameters, mask, motion and so on
- Support a maximum of 8 user permission groups including Administrator, Advanced and Ordinary which are the default permission groups of the system
- Support a maximum of 16 users to be created, multiple web clients login by using one username at the same time and the user's permission control to be enabled or disabled
- Support a maximum of 10 web clients login at the same time

Live Preview

- Support 4K×2K/1920×1080/1280×1024 HDMI and 1920×1080/1280×1024 VGA high definition synchronous display

- Support multi-screen modes such as 1/4/6/8/9/13/16/25/36
- Support auto adjustment of the camera's image display proportion
- Support audio monitoring of the camera to be enabled or disabled
- Support manual snap of the preview camera
- Support the sequence of the preview cameras to be adjusted
- Support display mode to be added and saved and the saved modes can be called directly
- Support quick tool bar operation of the preview window
- Support camera group view and scheme view in sequence, quick sequence view and dwell time setting
- Support motion detection and video mask
- Support multiple popular P.T.Z. control protocol and setup of the preset and cruise
- Support direct mouse control of the IP dome including rotating, zoom, focusing and so on
- Support single camera image to be zoomed by sliding the scroll wheel of the mouse
- Support any area of the image to be zoomed in to a maximum of 16 times of the current size
- Support image and lens adjustment (only available for some cameras)
- Support quick camera adding in the camera window of the live preview interface
- The live camera sequence of the web client will keep consistent with that of the NVR after adjusting the live camera sequence of the NVR, but the live camera sequence of the NVR will not be changed if that of the web client is changed

Disk Management

- The NVRs with the 3U case can add a maximum of 16 SATA HDDs; a maximum of 8 SATA HDDs with the 2U case, a maximum of 4 SATA HDDs with the 1.5U case, a maximum of 2 SATA HDDs with the 1U case and a maximum of 1 SATA HDD with the small 1U case
- Each SATA interface of the NVR supports the HDDs with max 8TB storage capacity
- Some of the NVRs support record to be backed up by e-SATA HDD
- Support disk group configuration and management and each camera can be added into different disk groups with different storage capacity
- Support disk information and disk working status viewing
- Support batch formatting of the disks

Record Configuration

- Support main stream and sub stream recording at the same time and batch or single configuration of the record stream
- Support manual and auto record modes
- Support schedule recording, sensor alarm recording and motion detection recording, etc

- Support schedule recording and event recording setting with different record streams
- Support record schedule setting and recycle recording
- Support pre recording and delay recording configuration of the event recording

Record Playback

- Support time scale operation in quick playback and the playback date and time can be set randomly by scrolling the mouse; the time interval of the time scale can be zoomed
- Support record searching by time slice/time/event/tag
- Support time view and camera view in searching by time slice mode
- Support time slice searching by month, by day, by hour and by minute and time slice to be displayed with camera thumbnail
- Support a maximum of 16 cameras to be searched by time
- Support event searching by manual/motion/sensor/intelligent events
- Support tag searching by the manual added tags
- Support instant playback of the selected camera in the live preview interface
- Support a maximum of 16 synchronous playback cameras
- Support acceleration(maximum 32 times of the normal speed), deceleration (minimum 1/32 times of the normal speed) and 30s' addition or reduction to current playing time

Record Backup

- Support record to be backed up through USB (U disk, mobile HDD) or e-SATA interface
- Support record to be backed up by time/event/image searching
- Support record cutting for backing up when playing back
- Support a maximum of 10 backup tasks in background and backup status viewing

Alarm Management

- Support alarm schedule setting
- Support enabling or disabling of the motion detection, external sensor alarm input, intelligence alarm and exception alarms including IP address conflict alarm, disk IO error alarm, disk full alarm, no disk alarm, illegal access alarm, network disconnection alarm, IPC offline alarm and so on, alarm trigger configuration supportable
- Support IPC offline alarm trigger configuration of PTZ, snap, pop-up video, etc.
- Support event notification modes of alarm-out, pop-up video, pop-up message box, buzzer, e-mail and so on
- The snapped images can be attached into the e-mail when alarm linkage is triggered
- Support alarm status view of alarm-in, alarm-out, motion detection and exception alarm

- Support alarm to be triggered and cleared manually
- Support system auto reboot when exception happens

Network Functions

- Support TCP/IP and PPPoE, DHCP, DNS, DDNS, UPnP, NTP, SMTP protocol and so on
- Support black and white list function and the IP address/IP segment/MAC address can be allowed or blocked.
- Support multiple browsers including IE8/9/10/11, Firefox, Opera, Chrome (available only for the versions lower than 45) and Safari in MAC system
- Support remote achievement, configuration, import and export of the NVR parameters and other system maintenance operations including remote upgrading and system restart
- Support remote camera configuration of the NVR including video parameters, image quality and so on
- Support remote searching, playback and backup of the NVR
- Support manual alarm to be triggered and cleared remotely
- The auto-focusing camera can be adjusted through web client (support zoom in/out, but one key focus is not currently supported)
- Support NVMS or other platform management software to access the NVR and manage it
- Support NAT function and QRCode scanning by mobile phone and PAD
- Support mobile surveillance by phones or PADs with iOS or Android OS
- Support NVR to be accessed remotely through telnet and the telnet function can be enabled or disabled
- If one camera recording is enabled or disabled manually through web client, it will be simultaneously enabled or disabled in the NVR

Other Functions

- The NVR can be controlled and operated by the buttons on the front panel, the remote controller and the mouse
- Setting interfaces can be switched to one another conveniently by clicking the main menus on the top of the setting interfaces
- Support NVR information viewing including basic, camera status, alarm status, record status, network status, disk and backup status
- Support factory restoring, import and export of the system configuration, log view and export and local upgrading by USB mobile device
- Support auto recognition of the displayer's resolution
- You can click the right mouse button at any interface to go back to the upper interface
- You can click the middle mouse button at any interface to go to the live view interface
- The display language and video format of the NVR will not be changed and the system logs will be reserved if you reset the NVR to factory default
- Press and hold the right mouse button for 5 seconds in any interface to switch the output to VGA and the NVR will display the video at the lowest resolution which the NVR supports

1.3 Front Panel Descriptions





The following descriptions are for reference only.

Type I:

Name	Descriptions
REC	When recording, the light is blue
Net	When access to network , the light is blue
Power	Power indicator, when connection , the light is blue
Fn	No function temporarily

Type II:

Name	Descriptions
Power	Power Indicator, when connected, the light is blue
HDD	The light turns blue when reading/writing HDD
Net	The light turns blue when it is able to access the network

Name	Descriptions
Backup	The light turns blue when backing up files and data
Play	The light turns blue when playing video
REC	Power Indicator, when connected, the light is blue
AUDIO /+	1. Adjust audio 2. Increase the value in setup
P.T.Z / -	1. Enter PTZ mode 2. Decrease the value in setup
MENU	Enter Menu in live
INFO	Check the information of the device
BACKUP	Enter backup mode in live
SEARCH	Enter search mode in live
Exit	Exit the current interface
	Manually record
	Play/Pause
	Speed down
	Speed up
1-9	Input digital number and select camera
0/--	Input number 0, the number above 10
Direction Key	Change direction
Multi-Screen Switch	Change the screen mode
Enter	Confirm selection
USB	To connect external USB device like USB mouse or USB flash

1.4 Rear Panel Descriptions

Here we only take a part of real panels for example to introduce their interfaces and connections. The interfaces and locations of the interfaces are only for references. Please take the real object as the standard.

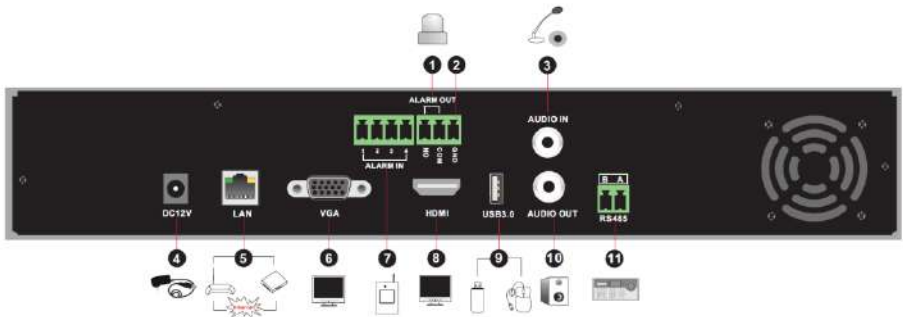

No.	Name	Descriptions
1	ALARM OUT	Relay output; connect to external alarm
2	GND	Grounding
3	AUDIO IN	Audio input; connect to audio input device, like microphone, pickup, etc
4	DC12V	DC12V power input
5	LAN	Network port
6	VGA	Connect to monitor
7	ALARM IN	Alarm inputs for connecting sensors
8	HDMI	Connect to high definition display device
9	USB	Connect USB storage device or USB mouse
10	AUDIO OUT	Audio output; connect to sound box
11	RS485	Connect to keyboard. A is TX+; B is TX-

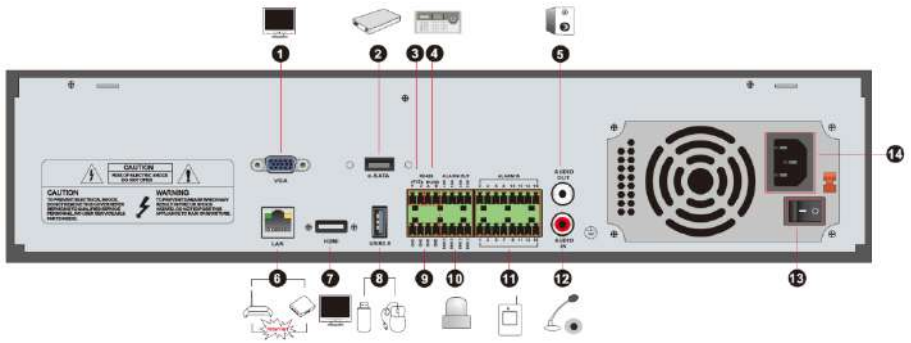

No.	Name	Descriptions
1	VGA	Connect to monitor
2	e-SATA	Connect to HDD with e-SATA interface
3	RS485 Y/Z interface	Connectors for speed dome. Y is TX+, Z is TX- (This interface of some models is unavailable.)
4	RS485 A/B interface	Connect to a keyboard. A is TX+; B is TX-
5	AUDIO OUT	Audio output; connect to sound box
6	LAN	Network port
7	HDMI	Connect to high definition display device
8	USB	Connect USB storage device or USB mouse
9	GND	Grounding
10	ALARM OUT	Relay output; connect to external alarm
11	ALARM IN	Alarm inputs for connecting sensors
12	AUDIO IN	Audio input; connect to audio input device, like microphone, pickup, etc
13	Power Switch	Press the switch to turn on/off the NVR
14	Power Supply	Power supply interface

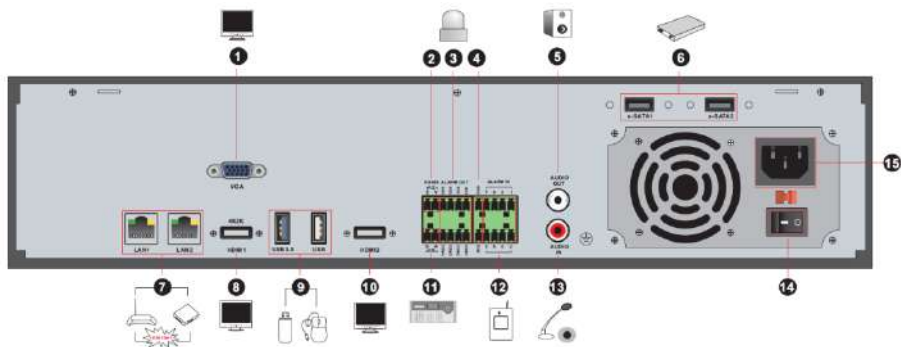

No.	Name	Descriptions
1	VGA	Connect to monitor
2	RS485 Y/Z interface	Connect to speed dome. Y is TX+, Z is TX- (This interface of some models is unavailable.)
3	ALARM OUT	Relay output; connect to external alarm
4	GND	Grounding
5	AUDIO OUT	Audio output
6	e-SATA1/ e-SATA2	Connect to HDD with e-SATA interface
7	LAN1/LAN2	Network port
8	HDMI1	Connect to 4K×2K high definition display device
9	USB3.0/USB	USB3.0 and USB 2.0 interface, connect USB storage device or USB mouse
10	HDMI2	Connect to 1920×1080 high definition display device. Connect to monitor as an AUX output channel by channel. Only video display, no menu show
11	RS485 A/B interface	Connect to a keyboard. A is TX+; B is TX-
12	ALARM IN	Alarm inputs for connecting sensors
13	AUDIO IN	Audio input
14	Power Switch	Press the switch to turn on/off the NVR
15	Power Supply	Power supply interface

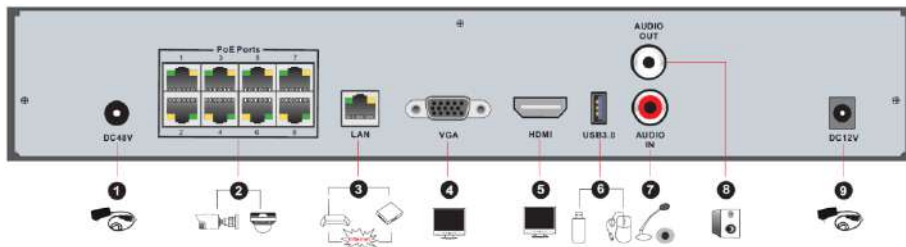

No.	Name	Descriptions
1	Power Supply	DC48V power supply interface
2	PoE port	8 PoE network ports; connect to 8 PoE IP cameras
3	LAN	Network port
4	VGA	Connect to monitor
5	HDMI	Connect to 1920×1080 high definition display device
6	USB3.0	USB3.0 interface, connect USB storage device or USB mouse
7	AUDIO IN	Audio input; connect to audio input device, like microphone, pickup, etc
8	AUDIO OUT	Audio output; connect to sound box
9	Power Supply	DC12V power supply interface

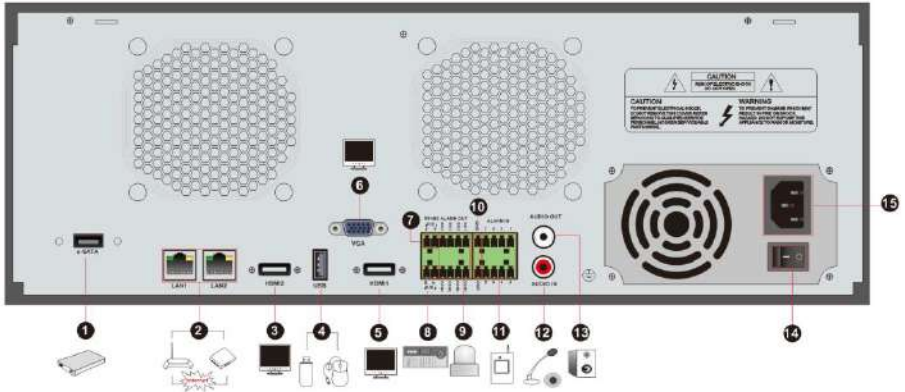

No.	Name	Descriptions
1	e-SATA	Connect to HDD with e-SATA interface
2	LAN1/LAN2	Network port
3	HDMI2	Connect to 1920×1080 high definition display device. Connect to monitor as an AUX output channel by channel. Only video display, no menu show
4	USB	USB interface, connect USB storage device or USB mouse
5	HDMI1	Connect to 4K×2K high definition display device
6	VGA	Connect to monitor
7	RS485 Y/Z interface	Connect to speed dome. Y is TX+, Z is TX- (This interface of some models is unavailable.)
8	RS485 A/B interface	Connect to keyboard. A is TX+; B is TX-
9	ALARM OUT	Relay output; connect to external alarm
10	GND	Grounding
11	ALARM IN	Alarm inputs for connecting sensors
12	AUDIO IN	Audio input; connect to audio input device, like microphone, pickup, etc
13	AUDIO OUT	Audio output; connect to sound box
14	Power Switch	Press the switch to turn on/off the NVR
15	Power Supply	Power supply interface

1.5 Connections

- **Video Connections**

Video Output: Supports VGA/HDMI video output. You can connect to monitor through these video output interfaces simultaneously or independently.

- **Audio Connections**

Audio Input: Connect to microphone, pickup, etc.

Audio Output: Connect to headphone, sound box or other audio output devices.

- **Alarm Connections**

Some models may not support this function. Take 16 CH alarm inputs and 1 CH alarm output for example.

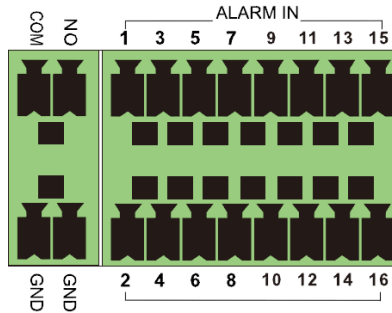

Alarm Input:

Alarm IN 1~16 are 16 CH alarm input interfaces. There are no type requirements for sensors. NO type and NC type are both available.

The way to connect sensor and the device is as shown below:



The alarm input is an open/closed relay. If the input is not an open/closed relay, please refer to the following connection diagram:

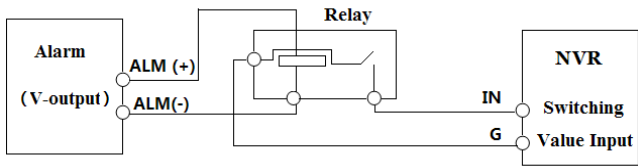

Alarm Output:

The way to connect alarm output device:

Pull out the green terminal blocks and loosen the screws in the alarm-out port. Then insert the signal wires of the alarm output devices into the port of NO and COM separately. Finally, tighten the screws. Provided that the external alarm output devices need power supply, you can connect the power supply as per the following figures.

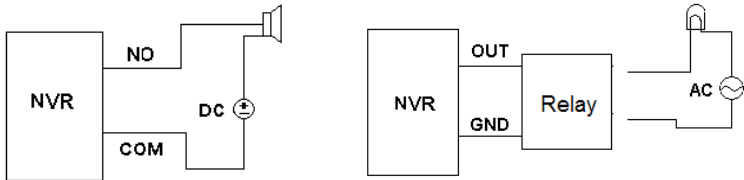

- ### RS485 Connection

There are two types of RS485 interfaces:

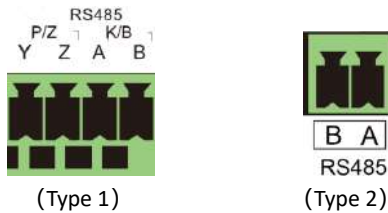

Type 1: The P/Z interfaces are unavailable temporarily. K/B interfaces are used to connect keyboard.

Type 2: The RS485 interfaces are used to connect keyboard. A is TX+; B is TX-.

2 Basic Operation Guide

2.1 Startup & Shutdown

Please make sure all the connections are done properly before you power on the unit. Proper startup and shutdown are crucial to extending the life of your device.

2.1.1 Startup

- ① Connect the output display device to the VGA/HDMI interface of the NVR.
- ② Connect with the mouse and power. The device will boot and the power LED would turn blue.
- ③ A WIZARD window will pop up (you should select the display language the first time you use the NVR). Refer to [3.1 Startup Wizard](#) for details.

2.1.2 Shutdown

You can power off the device by using remote controller or mouse.

By remote controller:

- ① Press the Power button. This will take you to a shutdown window. The unit will power off after a while by clicking the "OK" button.
- ② Disconnect the power.

By mouse:

- ① Click Start→Shutdown to pop up the Shutdown window. Select "Shutdown" in the window. The unit will power off after a while by clicking the "OK" button.
- ② Disconnect the power.

2.2 Remote Controller

- ① It uses two AAA size batteries.
- ② Open the battery cover of the remote controller.
- ③ Place batteries. Please take care the polarity (+ and -).
- ④ Replace the battery cover.

Key points to check in case the remote doesn't work.

1. Check batteries polarity.
2. Check the remaining charge in the batteries.
3. Check IR controller sensor for any masking.

If it still doesn't work, please change a new remote controller to try, or contact your dealers. You can just turn the IR sensor of the remote controller towards the IR receiver of the NVR to control it when you are controlling multiple devices by remote controller.

There are two kinds of remote controller. The interface of remote controller is shown as below.



Button	Function
Power Button	Switch off—to stop the device
Record Button	To start recording
-/-- /0-9	Input number or choose camera
Fn1 Button	Unavailable temporarily
Multi Button	To choose multi screen display mode
Next Button	To switch the live image
SEQ	To go to sequence view mode
Audio	To enable audio output in live mode
Switch	No function temporarily
Direction button	To move cursor in setup or pan/title PTZ
Enter Button	To confirm the choice or setup
Menu Button	To go to menu
Exit Button	To exit the current interface
Focus/IRIS/Zoom/PTZ	To control PTZ camera
Preset Button	To enter into preset setting in PTZ mode
Cruise Button	To go to cruise setting in PTZ mode
Track Button	No track function temporarily
Wiper Button	No function temporarily
Light Button	No function temporarily
Clear Button	No function temporarily
Fn2 Button	No function temporarily
Info Button	Get information about the device
	To control playback. Play(Pause)/Stop/Previous Frame/Next Frame/Speed Down/Speed Up
Snap Button	To take snapshots manually
Search Button	To go to search mode
Cut Button	No function temporarily
Backup Button	To go to backup mode
Zoom Button	To zoom in the images
PIP Button	No function temporarily

Note:

You shall press P.T.Z button to enter PTZ setting mode, choose a channel and press P.T.Z button again to hide the P.T.Z control panel. Then you can press preset, cruise, track, wiper or light button to enable the relevant function.



Button	Function
REC	Record manually
Search	To enter search mode
MEUN	To enter menu
Exit	To exit the current interface
ENTER	To confirm the choice or setup
Direction button	To move cursor in setup
ZOOM	To zoom in
PIP	No function temporarily
	To control playback. Play(Pause)/Next Frame/Speed Up/Stop/Previous Frame/Speed Down
Multi	To choose multi screen display mode
Next	To switch the live image
SEQ	To go to sequence view mode
INFO	Get information about the device

2.3 Mouse Control

➤ Mouse control in Live Display & Playback interface

In the live display & playback interface, double click on any camera window to show the window in single screen mode; double click the window again to restore it to the previous size.

In the live display & playback interface, if the interfaces display in full screen, move the mouse to the bottom of the interface to pop up a tool bar. The tool bar will disappear automatically after you move the mouse away from it for some time; move the mouse to the right side of the interface to pop up a panel and the panel will disappear automatically after you move the mouse away from it.

➤ Mouse control in text-input







Move the mouse to the text-input box and then click the box. The input keyboard will pop up automatically.

Note: Mouse is the default tool for all operations unless an exception as indicated.







2.4 Text-input Instruction



The system includes two input boxes. Refer to the above pictures. The left box is the number input box and the right box is the input box which provides inputs of numbers, letters and punctuation characters. The introductions of keys on the input boxes are shown below.

Button	Meaning	Button	Meaning
	Backspace key		Switch key of punctuation character
	Delete Key		Enter key
	Switch key between upper and lower letter		Space key
	Switch key of language		

2.5 Common Button Operation

Button	Meaning
	Click it to show the menu list.
	Click it to change the sequence of the list.
	Click it to change the camera displaying mode.
	Click it to close the current interface.
	Click it to go to the earliest date of camera recording.
	Click it to go to the latest date of camera recording.

3 Wizard & Main Interface

3 Wizard & Main Interface

3.1 Startup Wizard

The disk icons will be shown on the top of the startup interface. You can view the number and status of each disk quickly and conveniently through these icons (🟡: no disk; 🟠: unavailable disk; 🟢: RW available disk).

You can quickly configure the NVR by wizard setup to make the NVR work normally. You must configure the wizard if you start the NVR for the first time (or click "Skip" to cancel the wizard next time).

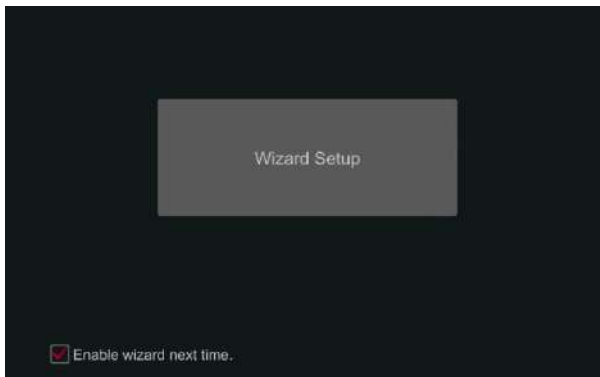

Click "Wizard Setup" to start wizard. The setting steps are as follows.

① **System Login.** Set your own password or use the default when you use the wizard for the first time (the default username of the system is admin and the default password of admin is **123456**); select the login username and enter the corresponding password next time.

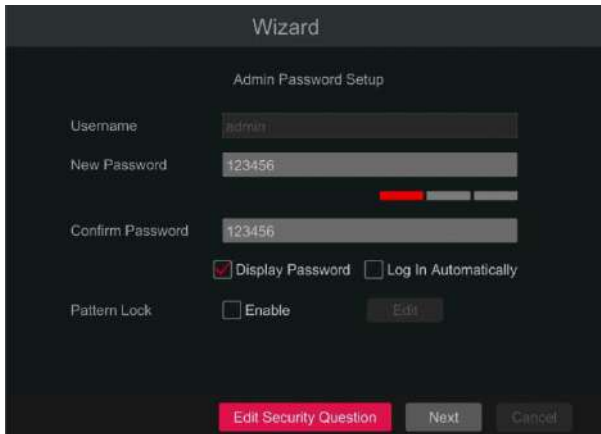

The screenshot shows a dark-themed window titled "Wizard" with a subtitle "Admin Password Setup". It contains the following fields and controls:

- Username:** A text input field containing "admin".
- New Password:** A text input field containing "123456". To its right is a password strength indicator with a red bar.
- Confirm Password:** A text input field containing "123456".
- Display Password:** A checked checkbox.
- Log In Automatically:** An unchecked checkbox.
- Pattern Lock:** An unchecked checkbox, followed by an "Edit" button.

At the bottom, there are three buttons: "Edit Security Question" (highlighted in red), "Next", and "Cancel".

Enable pattern lock and click "Edit" to set the pattern lock.

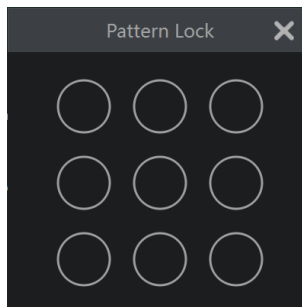

Click "Edit Security Question" to set questions and answers for password security of admin. If you forget the password, please refer to Q4 in [Appendix A FAQ](#) for details.

Click "Next" to continue or click "Cancel" to exit the wizard.

② **Date and Time Configuration.** The date and time of the system need to be set up if you use the wizard for the first time. Refer to the following figure. Set the time zone, system time, date format and time format. The DST will be enabled by default if the time zone selected includes DST. Click "Next" to continue.

The screenshot shows a 'Wizard' configuration window with the following settings:

- Time Zone: GMT+08 Beijing, Hong Kong, Shanghai, Tr
- System Time: 10/23/2018 11:28:18
- Date Format: Month/Day/Year
- Time Format: 24-Hour
- DST: OFF
- Synchronous: Manual
- NTP Server: time.windows.com

At the bottom, there are three buttons: 'Previous' (grey), 'Next' (red), and 'Cancel' (grey).

③ **Network Settings.** Check "Obtain an IP address automatically" and "Obtain DNS automatically" to get the IP address and DNS automatically (the DHCP function of the router in the same LAN should also be enabled), or manually input them. Input the HTTP port, RTSP port and Server port (please see [13.1.2 Port Configuration](#) for details). Click "Next" to continue.

The screenshot shows the 'Wizard' configuration window for 'Network Settings >'. The settings for 'Ethernet Port 1 (Online)' are as follows:

- Obtain an IP address automatically
- Address: 192.168.1.57
- Subnet Mask: 255.255.255.0
- Gateway: 192.168.1.1
- Obtain DNS automatically
- Preferred DNS: [empty]
- Alternate DNS: [empty]
- HTTP Port: 80
- RTSP Port: 554
- HTTPS Port: 443
- Server Port: 8038

At the bottom, there are three buttons: 'Previous' (grey), 'Next' (red), and 'Cancel' (grey).

Note:

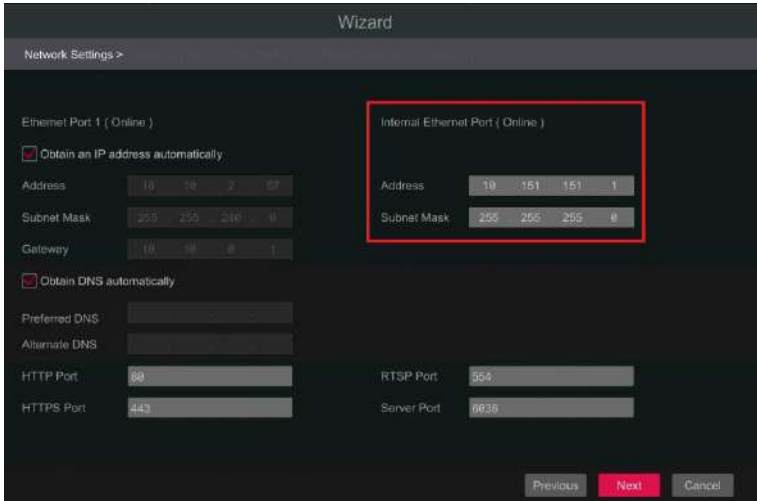

- If you use the NVR with the PoE network ports, the online state of the internal Ethernet port will be shown on the interface. Refer to the picture below. Please refer to [13.1.1 TCP/IP Configuration](#) for detail introduction of the internal Ethernet port.



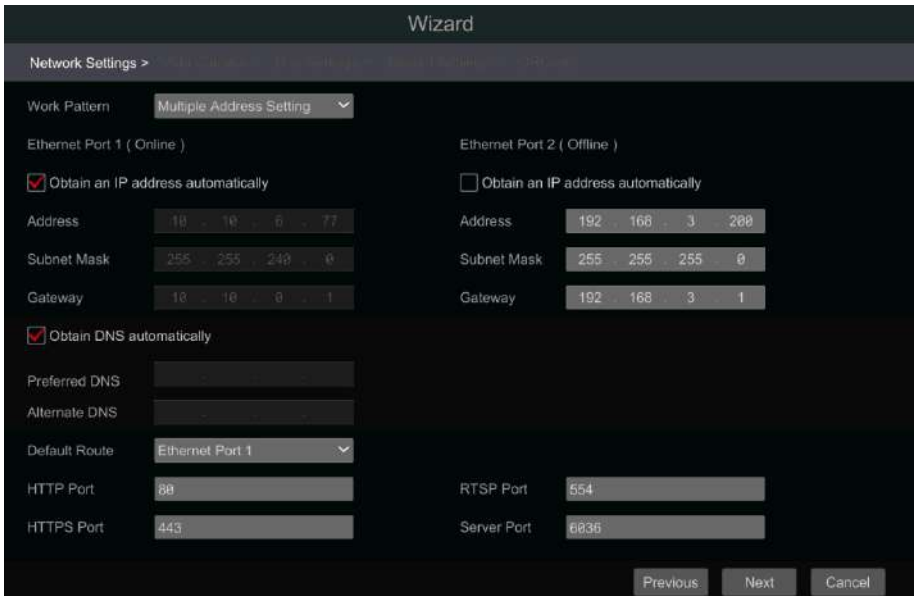

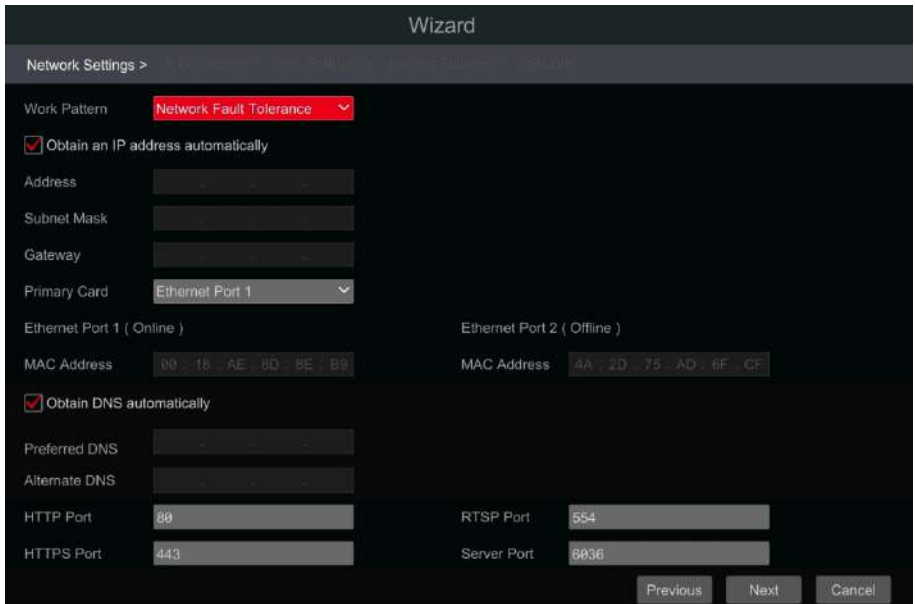
- If the NVR has two network ports or above, you can select the network work pattern as required. Network Fault Tolerance and Multiple Address Setting are available. Refer to the pictures below. Please refer to [13.1.1 TCP/IP Configuration](#) for more detailed information.





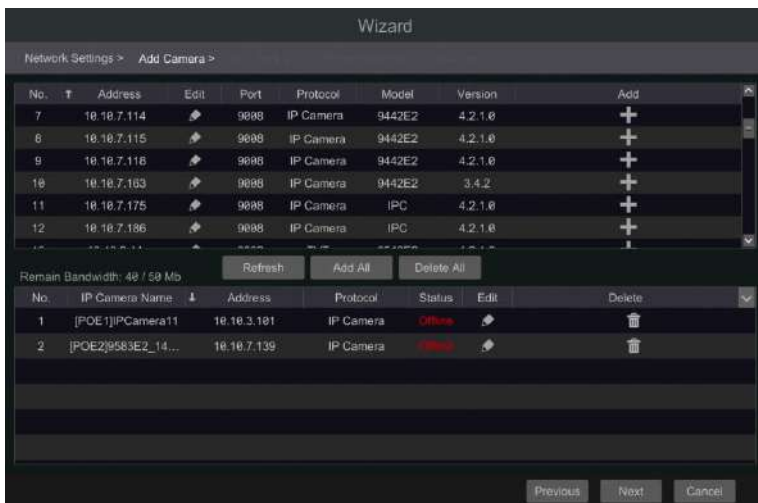

④ **Add Camera.** Click "Refresh" to refresh the list of online IP cameras which are in the same local network with NVR and then click  to add the searched camera. Click "Add All" to add all the cameras in the list. Click to delete the added camera. Click  "Delete All" to delete all the added cameras.

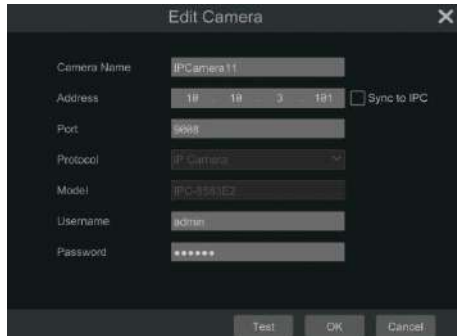

Click  to edit the searched IP camera as shown on the below left. Input the new IP address, subnet mask, gateway, username and the password of the camera. You can check "Sync to IPC" to modify the IP address of the IPC via different network segments for being in the same network segment with the NVR. Click "OK" to save the settings.

Click  to edit the added camera as shown on the above right. Input the new camera name, IP address, port, username and the password of the camera. You can click "Test" to test the effectiveness of the input information. Click "OK" to save the settings. You can change the IP camera name only when the added camera is online. Click "Next" to continue.

Tips: Please skip Step ⑤ and ⑥ if the NVR do not support RAID function.

⑤ **Disk Mode.** Click "Enable RAID" to enable the RAID function. Click "Next" to continue.

⑥ **Create an array.** Set the array name and select array type which including RAID0, RAID1, RAID5, RAID6 and RAID10. The global hot spares and array capacity can also be set up here. See [7.5 Disk](#) for details. Click "Next" to continue.

⑦ **Disk Settings.** You can view the disk number, disk capacity of the NVR and serial number, R&W status of the disk. Click "Formatting" to format the disk. Click "Next" to continue.

⑧ **Record Settings.** Two record modes are available: auto and manual.

Auto: Select one auto mode in the interface as shown below and then click the "Next" to save the settings. Click "Advanced" to self-define record mode. See [7.1.1 Mode Configuration](#) for details.

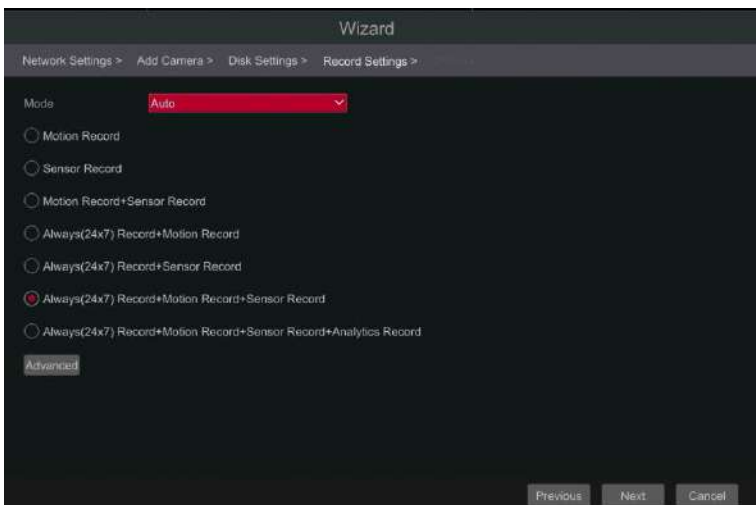

Manual: Set the “Sensor Record”, “Motion Record” and “Schedule Record” of each camera. Click “OK” to save the settings. See [7.1.1 Mode Configuration](#) for details.

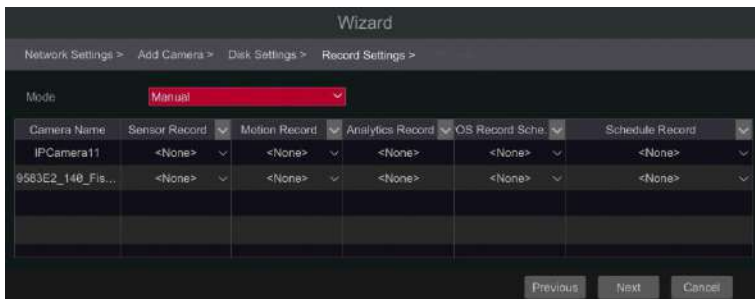

⑨ **QRCode.** Enable the NAT function in the interface or set it in the network configuration after exiting the wizard (please refer to [13.1.8 NAT Configuration](#) for details). You can scan the QRCode through mobile client which is installed in the mobile phone or PAD to log in the mobile client instantly. Please refer to [14.1 Mobile Client Surveillance](#) for details. Click “OK” to save the settings.

3.2 Main Interface

3.2.1 Main Interface Introduction



The buttons in area ① are introduced in the table below.

Button	Meaning
	Start button. Click it to pop up area ③.
	Full screen button. Click it to show full screen; click it again to exit the full screen.
	Screen mode button.
	Dwell button (see 5.2.2 Quick Sequence View and 5.2.4 Scheme View In Sequence for details).
	Click it to enable OSD; click to disable OSD.
	Click to set the default playback time before starting instant playback (8.1 Instant Playback) or going to the playback interface for playback operations (8.2 Playback Interface Introduction); click to go to the playback interface. For instance, if you choose “5 minutes ago” as the default playback time, you can playback the record from the past five minutes.
	Manual record button. Click it to enable/disable record.
	Manual alarm button. Click it to trigger or clear the alarm-out manually in the popup window.
	Record status button. Click it to view the record status.
	Alarm status button. Click it to view the alarm status.
	Disk status button. Click it to view the disk status and RAID status.
	Network status button. Click it to view the network status.

Button	Meaning
	Information button. Click it to view system information.

Introduction of area ②:

Area ② is hidden by default. Move the cursor to the right to reveal this area. Click “Camera” to view all the added cameras in the camera list. Select one camera window on the left side of the interface and then double click one camera in the list to preview the camera image in the selected window.





Tips: only some models support  icon. If no such icon, please skip the following related instructions.

Click  on the top right corner and then select “Single Channel Sequences” to view all the added groups in the group list; click one group in the list to view all the added cameras in the group (refer to [4.2 Add/Edit Camera Group](#) for detail configuration of the camera group). Select one camera window on the left side of the interface and then double click one group in the group list to preview the cameras’ images one by one in the selected window.

Click  on the top right corner and then select “Customize Display Modes” to view all the display modes in the display mode list (refer to [5.2.1 Preview By Display Mode](#) for detail configuration of the display mode). Double click one display mode in the list to switch to the display mode for previewing.

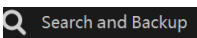
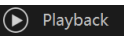
Click  on the top right corner and then select “Face Recognition” to go to face recognition interface. This function is only available for some modes.

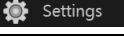
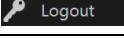
Introduction of area ③:

Icon / Button	Meaning
 admin	It shows the current login user.
	Click it to go to record search and backup interface, see 8.4 Record Search, Playback & Backup for details.
	Click it to go to playback interface (click  on the tool bar at the bottom of the live preview interface to set the default playback time), see 8.2 Playback Interface Introduction for details.
	Click it to pop up the setup panel, see 3.2.2 Setup Panel for details.
	Click it to log out the system.
	Click it and then select “Logout”, “Reboot” or “Shutdown” in the popup window.

3.2.2 Setup Panel

Click Start→Settings to pop up the setup panel as shown below.

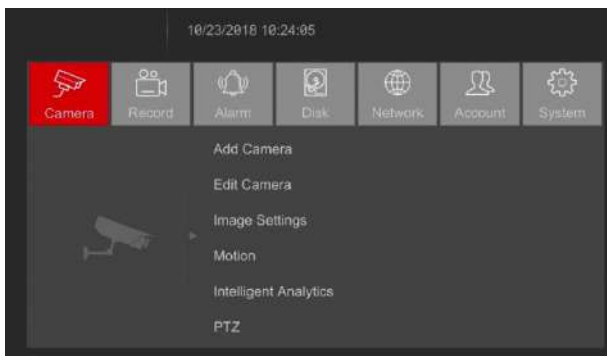

The setup panel includes seven modules. Each module provides some function entries with links for convenient operation.

Here we take **Camera** module as an example. The **Camera** module provides convenient links such as “Add Camera”, “Edit Camera”, “Image Settings”, “Motion”, “Intelligence Analysis” and “PTZ”. Click **Edit Camera** to go to the camera management interface as shown below.

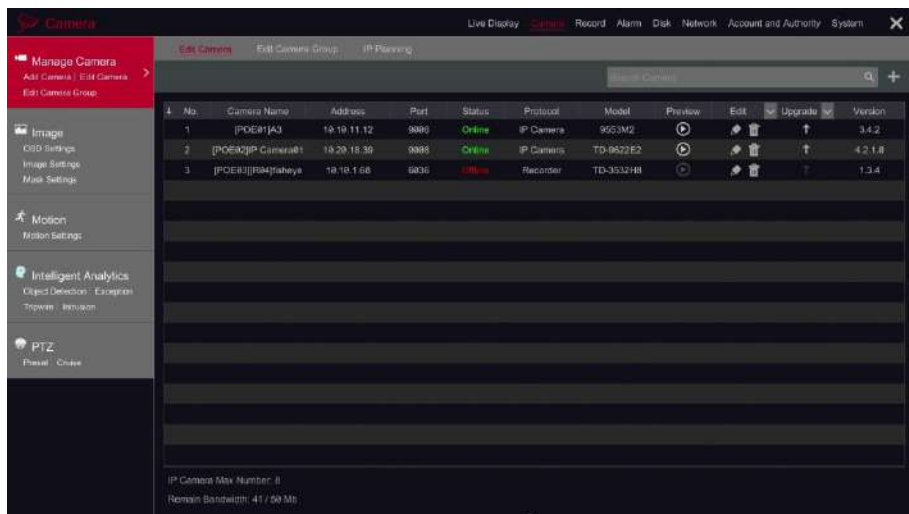

There are some function items on the left side of the camera management interface. Click each item to go to corresponding interface or window. For instance, click “Add Camera” to pop up the window as shown below.

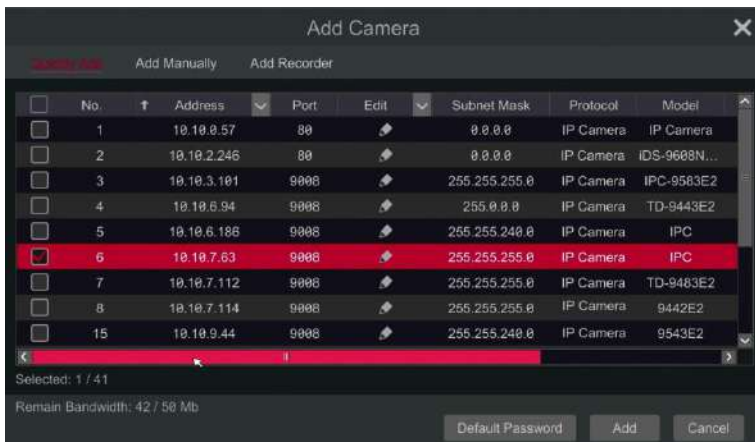

Click the main menus on the top of the camera management interface to go to corresponding interfaces. Refer to the picture below. For instance, you can go to system setup interface by clicking "System" tag.



3.2.3 Main Functions

➤ Camera

The module covers the functions such as **Camera Management** (see [Chapter 4 Camera Management](#) for details), **Image Settings** (see [5.4 Preview Image Configuration](#) for details), **Motion** (see [11.2.1 Motion Configuration](#) for details), and **PTZ** (see [Chapter 6 PTZ](#) for details) and so on.

➤ Record

The module covers the functions such as **Encode Parameters** and **Record Schedule** and so on. Please see [Chapter 7 Record & Disk Management](#) for details.

➤ Alarm

The module covers the functions such as **Sensor and Motion Alarm Handling** and **Alarm Out Settings**. Please see [Chapter 11 General Event Management](#) for details.

➤ Disk

The module covers the functions such as **Disk Management**, **Storage Mode** and **Disk Information** and so on. Please see [Chapter 7 Record & Disk Management](#) for details.

➤ **Network**

The module covers the functions such as **TCP/IP, DDNS, Port, E-mail** and **Network Status** and so on. Please see [13.1 Network Configuration](#) for details.

➤ **Account and Authority**

The module covers the functions such as **Account Management** (see [12.1 Account Management](#) for details) and **Permission Management** (see [12.3 Permission Management](#) for details) and so on.

➤ **System**

The module covers the functions such as **Basic Configuration** (see [13.2 Basic Configuration](#) for details), **Device Information** (see [13.8 View System Information](#) for details), **Log Information** (see [13.7 View Log](#) for details) and **Configuration File Import & Export** (see [13.5 Backup and Restore](#) for details) and so on.

4 Camera Management

4 Camera Management

4.1 Add/Edit Camera

4.1.1 Add Camera

The network of the NVR should be set before adding IP camera (see [13.1.1 TCP/IP Configuration](#) for details).

Refer to the pictures below. Click **Add Camera** in the setup panel or **+** in the top right corner of the preview window to pop up the "Add Camera" window as shown below. You can quickly add or add the IP camera manually.

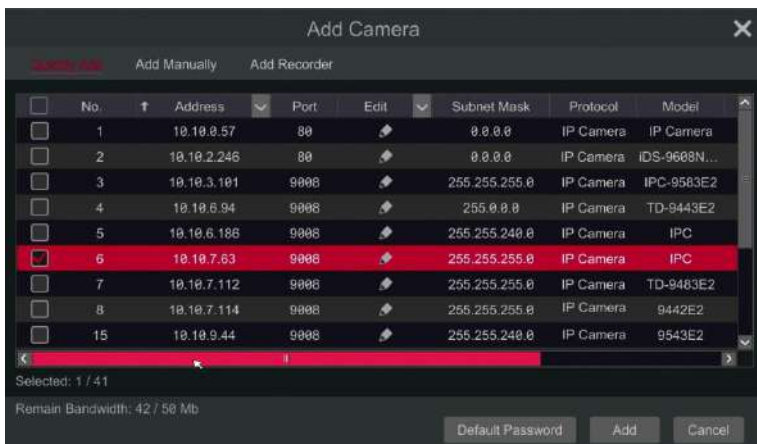



➤ Quickly Add

Check the cameras and then click "Add" to add cameras. Click  to edit the camera's IP address, username and password and so on. Click "Default Password" to set the default username and password of each camera.



➤ Add Manually

Enter the IP address or domain name (click  in the IP address column to pop up the domain name input window, input the domain name of the IPC in the window and then click "OK"), port, username and password of the camera and then select the protocol. Click "Test" to test the effectiveness of the input information and then click the "Add" button (you can input one camera's information or above such as IP address, username and password before clicking the "Add" button). Click  to delete the camera. Click "Default Password" to set the default username and password of each camera.

Note: Some models may not support this function.

Click Start→Settings→System→Basic→General Settings to check "Enable Add IPC by Zero Operation". If the NVR has unoccupied channels, it can add IPC without any operation by restarting.

➤ Add Recorder

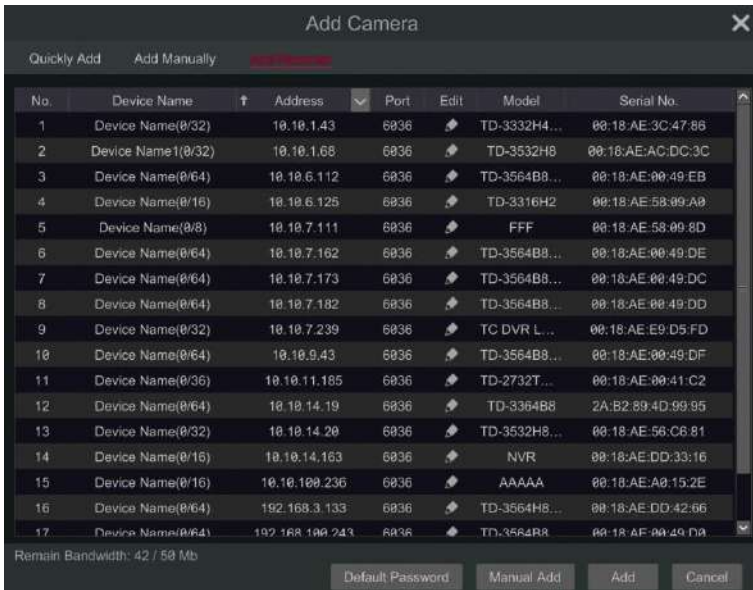



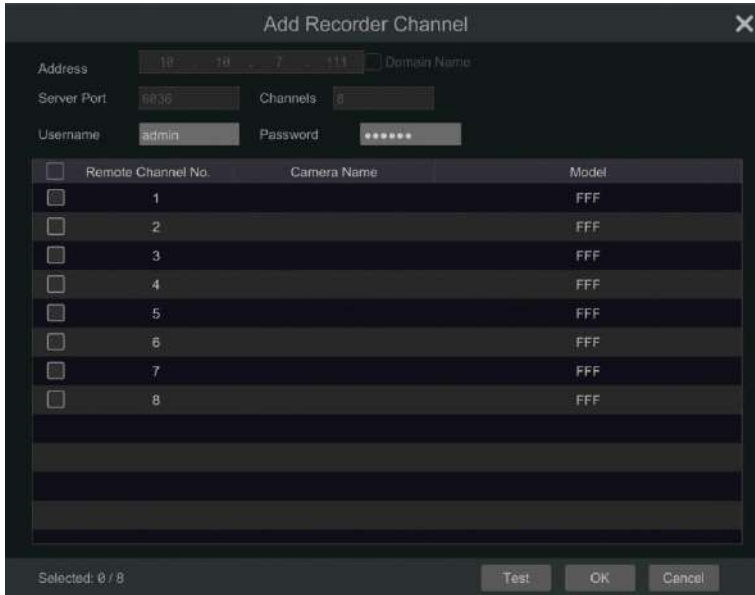



- Quickly Add: Select the searched NVR/DVR and the click "Add" to add NVR in the same local network.
- Manually Add: Click "Manual Add" and then enter the IP address or domain name, port, username and password of the NVR/DVR. Check the added remote channel number and click "Test" to test the effectiveness of the input information. Then click "OK" to return to the previous interface.



Note: Only the local NVR has unoccupied channels, may the IPC of other NVR/DVR in the same local network be added. And the added IPC supports previewing and recording.

4.1.2 Edit Camera

Click "Edit Camera" in the setup panel to go to the interface as shown below. Click  to view the live image of the camera in the popup window. Click  to edit the camera (see **Add camera** in [3.1 Startup Wizard](#) for details). Click  to delete the camera. Click  in the "Operation" header line and then click "Modify IPC Password" to pop up a window(check the IPCs in the window, set the new password and then click "OK"; only the online IPCs' passwords can be modified and a batch of IPCs' passwords can be modified at the same time). Click  to upgrade an online IPC (or click  in the "Upgrade" header line and then click "IPC Batch Upgrade" to upgrade a batch of IPCs), select the device which stores the upgrade file in the "Device Name" item of the popup window and the upgrade file in the list(you should select the upgrade IPC model in the window if a batch of IPCs' passwords need to be modified) and then click "Upgrade" to start upgrading(the IPC will restart automatically after the upgrade is completed successfully).

No.	Camera Name	Address	Port	Status	Protocol	Model	Preview	Edit	Upgrade	Version
1	A3	18.18.11.12	9068	Online	IP Camera	9553M2				3.4.2
2	IP Camera#1	18.28.18.39	9068	Online	IP Camera	TD-9622E2				4.2.1.9
3	fishaye	18.18.1.68	6836	Offline	Recorder	TD-3532H8				1.3.4

IP Camera Max Number: 8
Remain Bandwidth: 41 / 50 Mb

Note:

If you use the NVR with the PoE network ports, the IP cameras (with PoE function) which directly connect to the PoE port of the NVR will be displayed automatically in the camera list. Refer to the picture below. The IP camera which occupies the PoE resource has a prefix shown before its camera name. The prefix consists of PoE plus PoE port number. The IP camera which connects to the PoE port cannot be deleted from the camera list manually.

No.	Camera Name	Address	Port	Status	Protocol	Model	Preview	Edit	Upgrade	Version
1	[POE81]A3	18.18.11.12	9068	Online	IP Camera	9553M2				3.4.2
2	[POE62]IP Camera#1	18.28.18.39	9068	Online	IP Camera	TD-9622E2				4.2.1.9
3	[POE93][R04]fishaye	18.18.1.68	6836	Offline	Recorder	TD-3532H8				1.3.4

IP Camera Max Number: 8
Remain Bandwidth: 41 / 50 Mb

- The IP camera which directly connects to the PoE port of the NVR through private protocol will be shown automatically in the camera list.
- One of the two conditions must be met if the IP camera which directly connects to the PoE port of the NVR through ONVIF protocol should be shown automatically in the camera list.
 - ✓ The IP camera which directly connects to the PoE port is in the same network segment with the internal ethernet port.
 - ✓ The DHCP (obtain an IP address automatically) of the IP camera which directly connects to the PoE port is enabled.

If the IP camera which connects to the PoE port cannot be displayed automatically in the camera list, please refer to Q6 in [Appendix A FAQ](#) for details.

4.2 Add/Edit Camera Group

4.2.1 Add Camera Group

Click "Edit Camera Group" in the above interface to go to the interface as shown below.



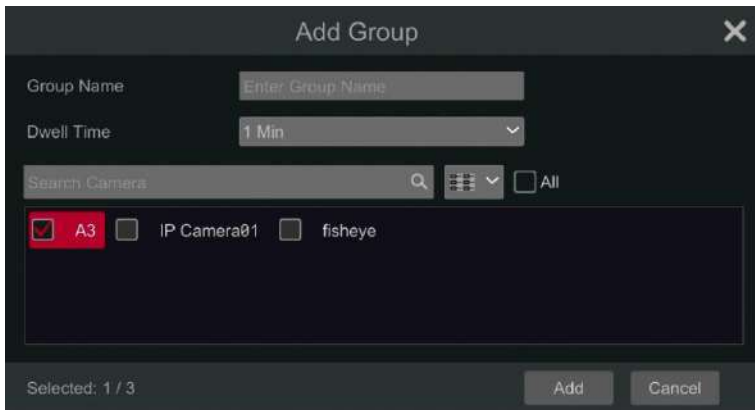

Click **+** to pop up the window as shown below. Set the group name and dwell time (the dwell time of the camera group sequence view) in the window. Check the cameras and then click "Add" to add group. Click **✓** to view the cameras in the group after adding group.



4.2.2 Edit Camera Group





Click  to modify the group information such as group name and dwell time. Click  to delete the group.

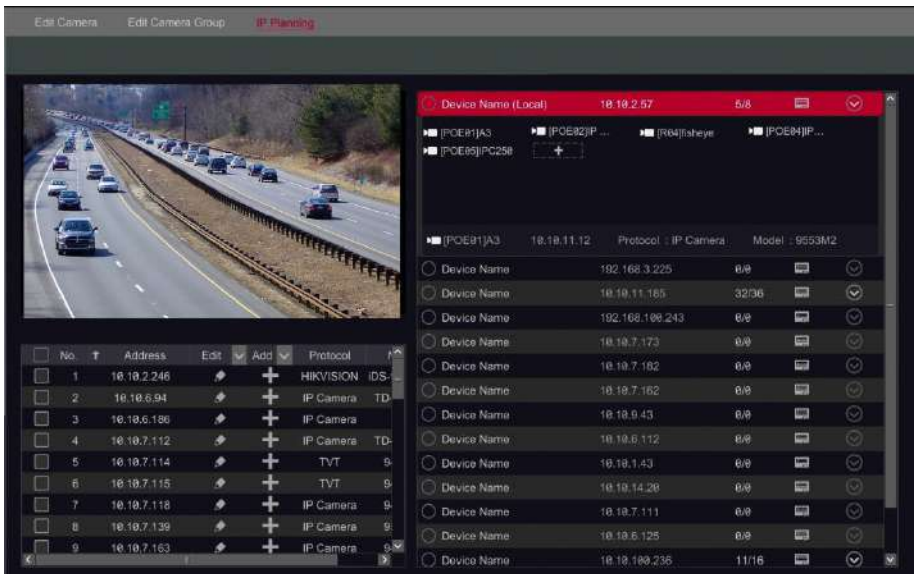

4.2.3 IP Planning

Some models may not support this function.

Click "IP Planning" to go to the interface as shown below. This function supports searching other NVRs/DVRs that is in the same local network as the local NVR. The user may add the IPC of other NVRs/DVRs into the unoccupied channels of the local NVR.



Click  to edit the IP address, user name or password and other information of the NVRs.

Click  behind the "Add" button to add the IPC selected and the user may edit the IP address, user name or password by clicking  behind the "Edit" button.

5 Live Preview Introduction

5 Live Preview Introduction





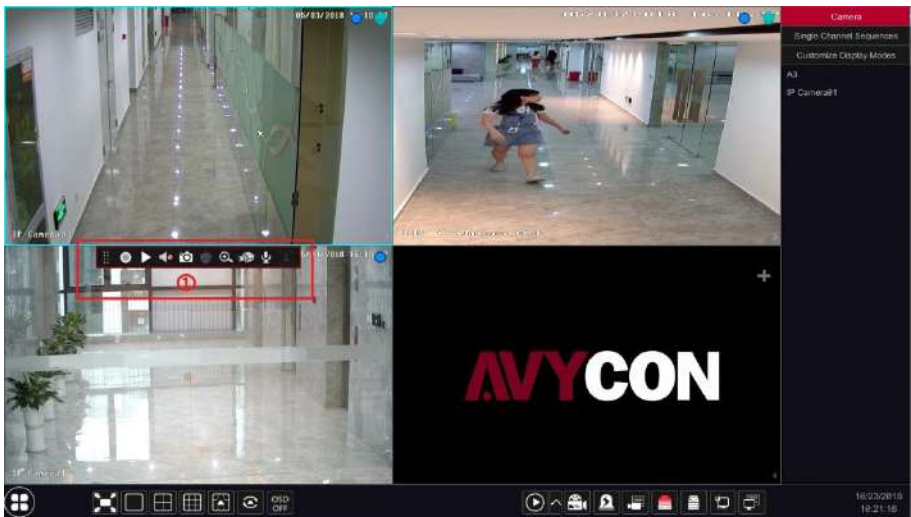

5.1 Preview Interface Introduction





You should add camera first after logging on to the system (see [4.1.1 Add Camera](#) for details). Refer to the interface as shown below, drag one camera in the preview window to another window for camera window exchanging.



The record symbols with different colors in the live preview window refer to different record types when recording: green stands for manual record, red stands for sensor based record, yellow stands for motion based record, blue stands for schedule record and cyan stands for intelligence record.



Click the preview window to show the tool bar as shown in area ①; right click the preview window to show the menu list. The tool bar and menu list are introduced in the table below.

Button	Menu List	Meaning
	--	Move tool. Click it to move the tool bar anywhere.
	Manually Record On	Click it to start recording.
	Instant Playback	Click  to playback the record; click “Instant Playback” to select or self-define the instant playback time. See 8.1 Instant Playback for details.
	Enable Audio	Click it to enable audio. You can listen to the camera audio by enabling audio.
	Snap	Click it to pop up the snap window. Click “Save” in the window to save the image. Click “Export” to export the image.

Button	Menu List	Meaning
	PTZ Control	Click it to go to PTZ control interface. See Chapter 6 PTZ for details.
	Zoom In	Click it to go to single channel amplification interface.
	--	Click it to go to image adjustment interface. Refer to 5.4.5 Image Adjustment for details.
	Start/Close Talk	Click it to start talk.
	Face Recognition	Click it to go to single channel face comparison interface. (only applicable to some models)
--	Camera Info	Click it to view the camera information.

The single channel amplification interface is as shown below. Press and drag the blue box to select the zoom in area. Click  /  to zoom the image. Click the camera selection box to select other cameras for amplification. Click “Back” to return to the live preview interface.



5.2 Preview Mode

5.2.1 Preview By Display Mode

Set different screen modes and cameras' display sequences as required and then save the display modes classified by surveillance areas, priorities and so on. Refer to the picture below. Double click one display mode in the display mode list to view the live images in this mode.



➤ **Add Display Mode**

Method One:

- ① Click "Customize Display Modes" in the above interface and then set the screen mode.
- ② Add the cameras and adjust the cameras' display sequence as required.
- ③ Click  under the display mode list and then enter the display mode name in the popup window, click "OK" to save the current display mode.

Method Two:

- ① Click Start→Settings→System→Basic→Output Settings to go to the interface and then set the screen mode.
- ② Double click the camera or camera group in the list to add them to the selected window.
- ③ Click  to save the current display mode (refer to [5.2.4 Scheme View In Sequence](#) for detail configurations). The display mode will be saved and displayed in the display mode list in the live preview interface.

➤ **Edit Display Mode**

Click "Customize Display Modes" tab in the live preview interface and then select one display mode in the list. Click  to edit the display mode name; click  to delete the display mode.

➤ **Corridor Pattern**

Some models may not support this function. Select corridor pattern in display mode. You can change the direction of the video image by using this function. Please refer to User Manual of relevant camera.



Change to corridor pattern

➤ **Fisheye Mode**

Some models may not support this function.



In the live preview, select the view mode according to the installation mode and display mode of the fisheye camera. Please refer to User Manual of relevant camera.

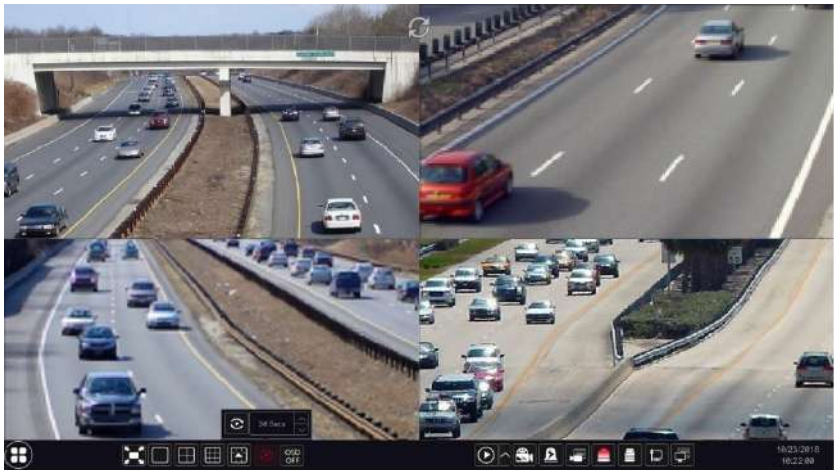

5.2.2 Quick Sequence View

You can start quick sequence view if the scheme has not been created. If the scheme has been created, please refer to [5.2.4 Scheme View in Sequence](#) for details.



Go to the live preview interface and then click  to pop up a little window. Set the dwell time in the window and then click  to view the live group by group according to the camera number of the current screen mode. Double click the sequence view interface to pause the view; double click again to restore the view. Click  to stop the view.

5.2.3 Camera Group View In Sequence

You can start camera group view in sequence if camera group has been created (see [4.2.1 Add Camera Group](#) for details).

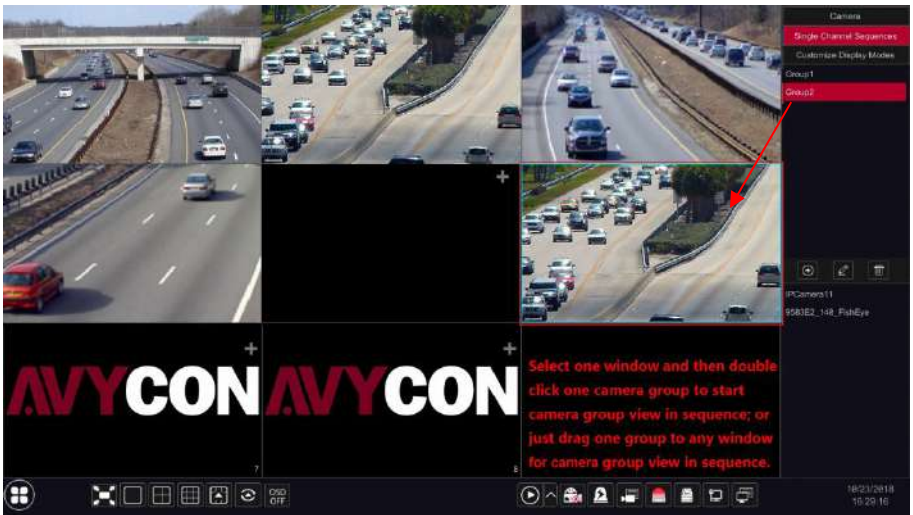

① Go to the live preview interface and then select a camera window.



② Double click one camera group on the right side of the interface. The cameras in the group will start camera group view one by one in the selected camera window.



You can also drag the group directly to any preview window. Right click on the group view window and then click "Close Dwell" to stop the view.

5.2.4 Scheme View In Sequence

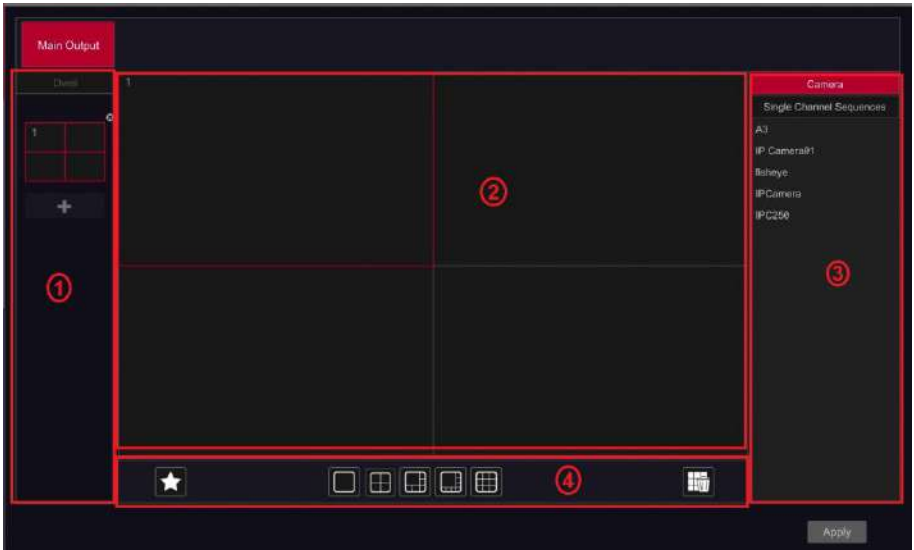
Click Start→Settings→System→Basic→Output Settings to go to the interface as shown below. Area ① displays all the dwell schemes; area ② shows the detailed information of the scheme; area ③ displays all the cameras and groups; area ④ is the tool bar ( : clear button;  : favorite button, click it to pop up a window, enter the display mode name in the window and then click "OK" to save the current display mode; other buttons are screen mode buttons).



➤ Add Scheme

Click  in area ① to create a new scheme. Click  on the top right corner of the scheme to delete it.

Configure Scheme

a) Select a scheme in area ① and then click the screen mode button on the tool bar to set the screen mode of the scheme.

b) Select a camera window in area ② and then double click the camera or group in area ③. The camera or group will be added into the selected window. One camera in the same scheme cannot repeat. You can click the right-click menu "Clear" in area ② to remove a single camera or click  to remove all the cameras.

c) Click "Apply" to save the settings.

➤ **Start Sequence View**

Go to live preview interface and then click  to pop up a window. Set the dwell time in the window and then click  to start scheme view in sequence. Double click the sequence view interface to pause the view; double click again to restore the view. Click  to stop the view.

Note:

You can set the secondary output preview if the NVR has dual outputs. Refer to the interface as shown below.

Check "Dwell" and then set scheme view in sequence of the adjuvant output. The setting steps are similar to that of the main output.

Set quick sequence view if "Dwell" is not checked. The setting steps are as follows:

- ① Set screen mode by clicking the relevant buttons on the tool bar.
- ② Select one window and then double click one camera or group in the list.
- ③ Click "Apply" to save the settings after adding cameras or groups to the windows.

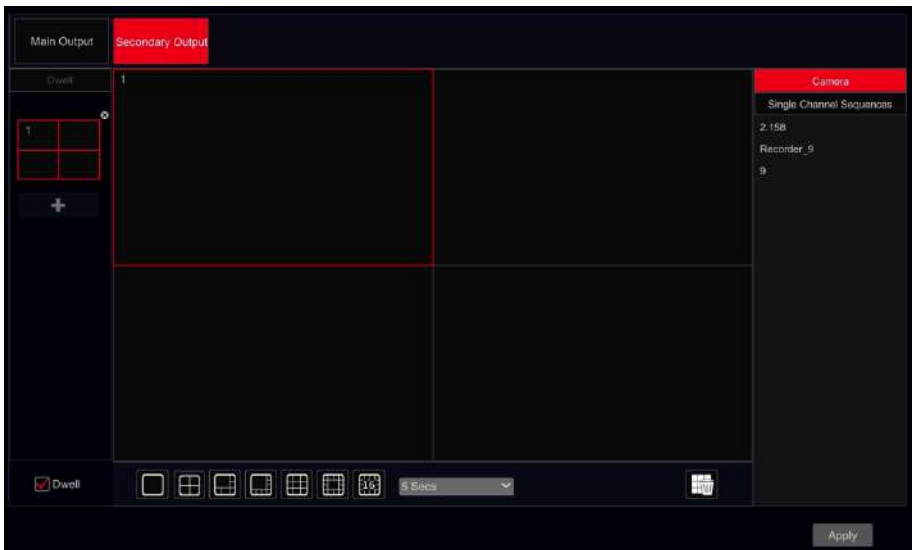

5.3 POS Settings

This function is only available for some models. If no such function, please skip the following instructions.

- ① Click Start→Settings→Basic→POS Settings to go to the interface.
- ② Enable POS and click "Configure" under "Connection Settings" to go to the following interface.
- ③ Enter IP address of the POS you want to add.
- ④ Check "Filter destination", "Filter POS port" and "Filter destination Port" (If you do not check them, please skip this step) and enter destination IP, POS port and destination port you want to filter.

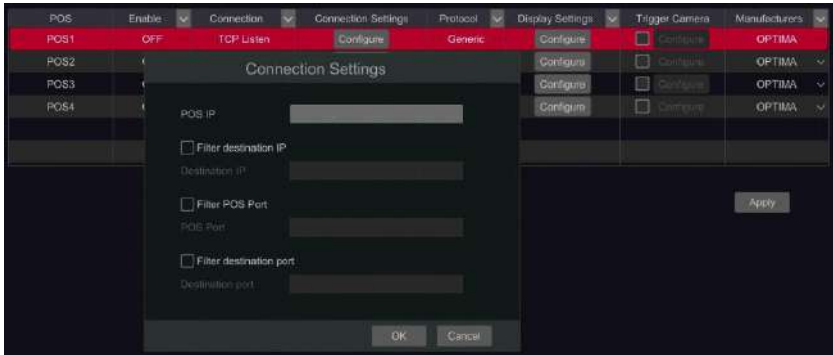

- ⑤ Click "Display Position" under "Display Settings" to set the position of the POS information (Use the default settings of the general settings).

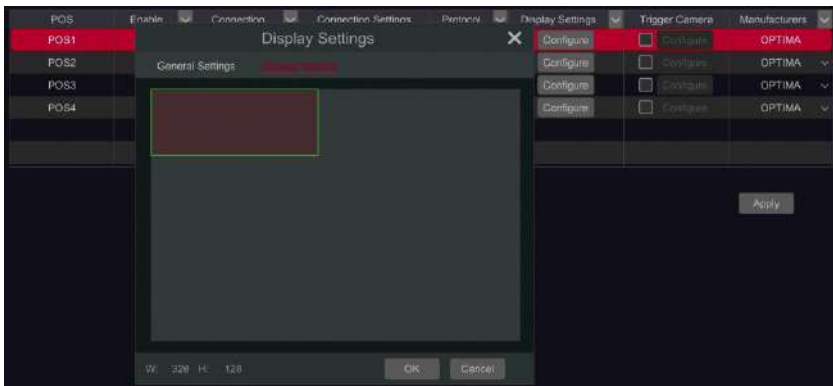

⑥ Check "Trigger Camera" and click "Configure" under it to bind POS to the camera. One POS can be bound to multiple channels, but one channel can only be bound to one POS.

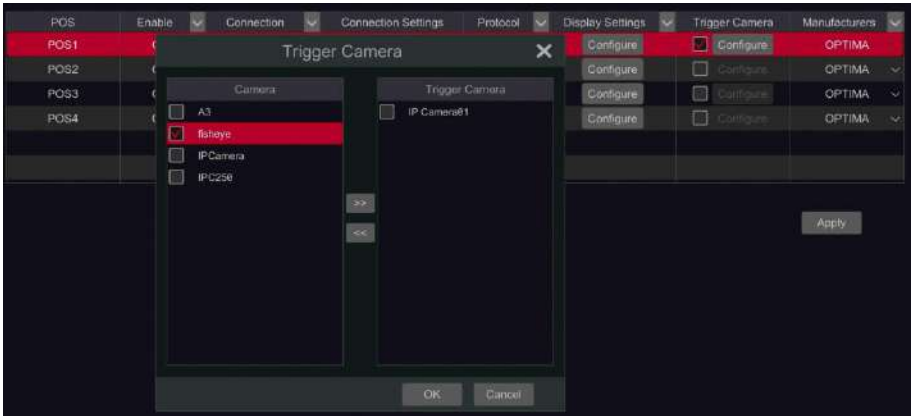

⑦ Click "Apply" to save the settings and then the transaction information will be displayed on the preview image in real-time. One POS is bound to one camera:

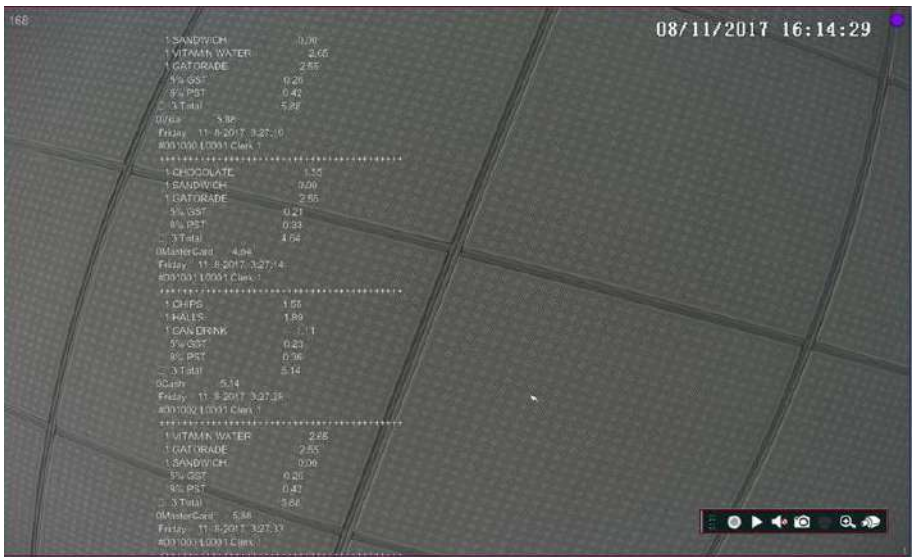

One POS is bound to multiple cameras:



5.4 Preview Image Configuration

5.4.1 OSD Settings

Click Start→Settings→Camera→Image→OSD Settings to go to the interface as shown below. Select the camera, enter the camera name (or double click the camera name in the camera list to change the camera name), enable or disable the name and time OSDs (if enabled, drag the red name and time OSDs directly in the image view area to change the OSDs' display position) and select the date and time formats. Click "Apply" to save the settings.

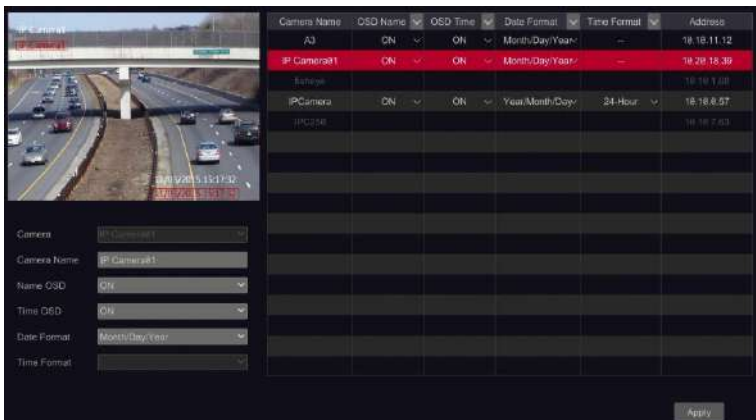

5.4.2 Image Settings

Click Start→Settings→Camera→Image→Image Settings to go to the following interface. Select the camera and then set the brightness, contrast, saturation and hue of the camera. Click the “Advanced” button or  in the camera list on the right side of the interface to pop up the “Image Adjust” interface and then set the relevant setting items. Please refer to [5.4.5 Image Adjustment](#) for detailed introductions of these items.

You can click “Default” to restore the image settings to the default factory settings.



5.4.3 Mask Settings

Some areas of the image can be masked for privacy. Up to four mask areas can be set for each camera. Click Start→Settings→Camera→Image→Mask Settings to go to the interface as shown below. Select the camera and enable the mask. Click the “Draw” button and then drag the mouse on the image area to set the mask area; click the “Delete” button to delete the mask areas; click “Apply” to save the settings.

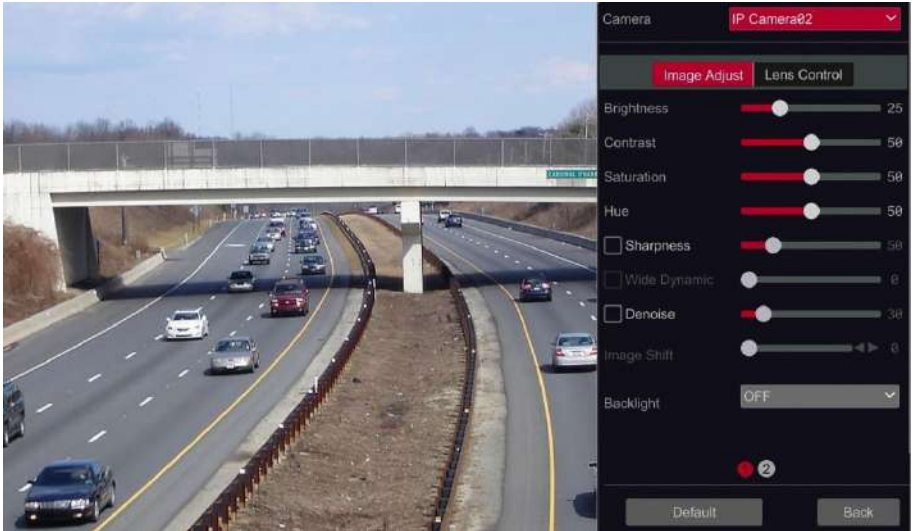

➤ **Image Adjustment**

Select the camera and then click “Image Adjustment” to go to image adjustment tab. Refer to the above picture. Drag the slider to set the camera’s brightness, contrast, saturation and hue value. Check sharpen, wide dynamic and denoise and then drag the slider to set the value. Click “Default” to set these parameters to default values.

The introductions of these parameters are as follows:

Parameter	Meaning
Brightness	It is the brightness level of the camera’s image.
Contrast	It is the color difference between the brightest and darkest parts.
Saturation	It is the degree of color purity. The color is purer, the image is brighter.
Hue	It relates to the total color degree of the image.
Sharpen	It relates to the resolution level of the image plane and the sharpness level of the image edge.
Wide Dynamic	The wide dynamic range (WDR) function helps the camera provide clear images even under back light circumstances. When there are both very bright and very dark areas simultaneously in the field of view, WDR balances the brightness level of the whole image and provide clear images with details.
Denoise	Decrease the noise and make the image more thorough. Increasing the value will make the noise reduction effect better but it will reduce the image resolution.
White Balance	Adjust the color temperature according to the environment automatically.
Image Mirror	Turn the current video image horizontally.
Image Flip	Turn the current video image vertically.

➤ **Lens Control**

Select the camera and then click "Lens Control" to go to lens control tab. Click **−** or **+** to adjust the zoom and focus parameters of the camera's lens. Click "Save" to save the settings.

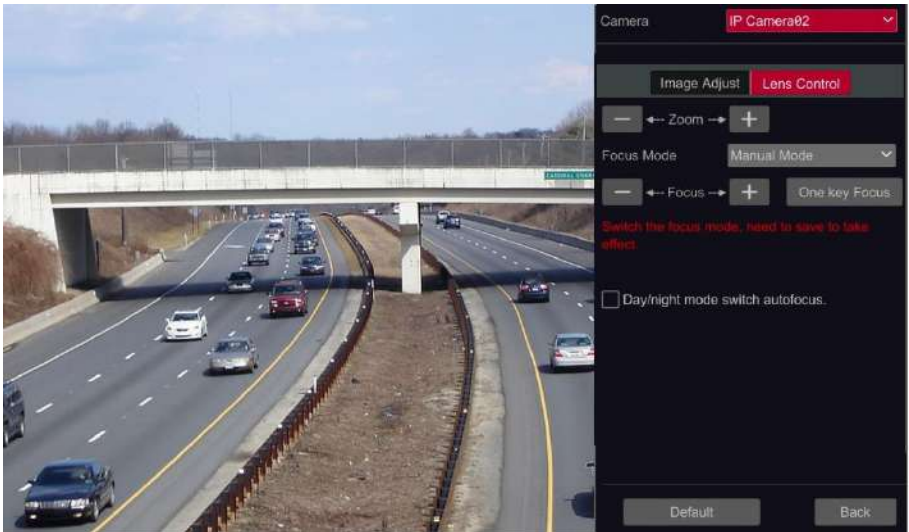

The introductions of these parameters and buttons are as follows.

Button/Parameter	Meaning
←Zoom→	Click + / − to zoom in/out the image.
Focus Mode	If manual mode is selected, focus button & "One Key Focus" & "Day/night mode switch autofocus" will be available; if auto mode is selected, the time interval setup will be available.
←Focus→	Click + / − to increase/decrease the focal length.
One key Focus	Click it to focus instantly.
Day/night mode switch autofocus	If checked, the lens will focus automatically when the camera is switching day/night mode.
Time Interval	It is the time interval when camera lens is auto-focusing. The interval can be set in the drop-down list.

Note: This function is only available for the models with auto varifocal lens, or the settings here are ineffective.







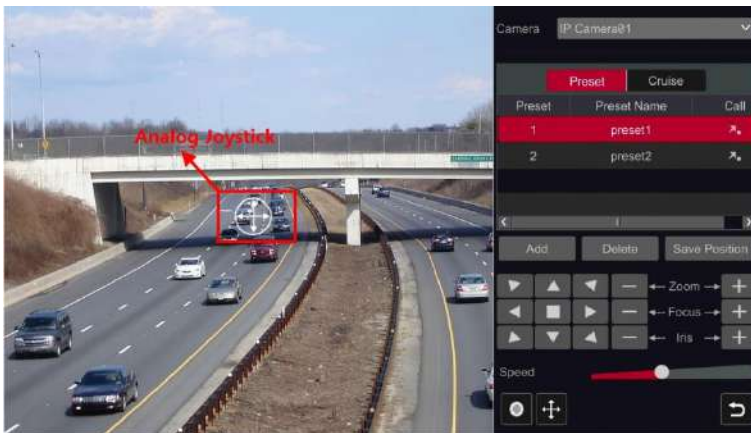













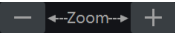

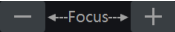
6 PTZ

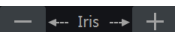
6.1 PTZ Control Interface Introduction

You can control the IP dome or PTZ which connects to the IP camera for PTZ control. Click  on the tool bar at the bottom of the live preview window to go to the PTZ control interface as shown below. You can select another IP dome or PTZ which connects to the IP camera on the top right of the interface for PTZ control.



Introductions of the buttons on the bottom right of the interface:

Button	Meaning
	Click  /  /  /  /  /  /  /  /  to rotate the dome. Click  to stop rotating the dome.
	Click  /  to zoom in / out the camera image.
	Click  /  to increase / decrease the focal length.
	Click  /  to increase / decrease the iris of the dome.
	Drag the slider to adjust the rotating speed of the dome.
	Click  to start / stop recording.
	Click  to hide / show the analog joystick.
	Click it to return to the live preview interface.

➤ Analog Joystick Control

The analog joystick on the left side of the interface provides quick PTZ control. The dome or PTZ will rotate when you drag the analog joystick. The farther you drag the analog joystick from the middle of the image, the faster the dome or PTZ rotates. The dome or PTZ will stop rotating when you stop dragging the analog joystick.

➤ 3D Control

Click the camera image on any area and then the image will be centered on the clicked point. Refer to the picture as shown below. Drag the mouse from A to B to get a green rectangle and the rectangle area will be zoomed in.



Refer to the picture as shown below. Drag the mouse from C to D to get a green rectangle and the rectangle area will be zoomed out.

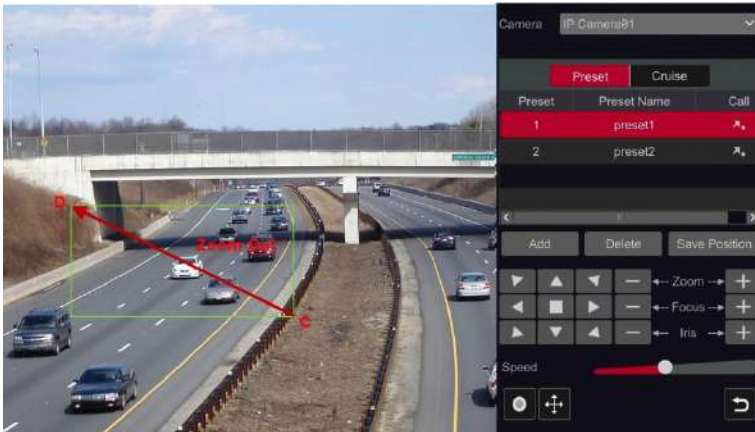



➤ Analog Joystick Control

Double click the left button of the mouse on any area of the camera image and then the image size will be doubled and centered on the clicked point. Press and hold the left button of the mouse on any area of the camera image to zoom in the image; press and hold the right button to zoom out the image. Move the cursor of the mouse to the camera image and then slide the scroll wheel of the mouse forward to zoom in the image, slide the scroll wheel of the mouse backward to zoom out the image.

➤ Preset Setting

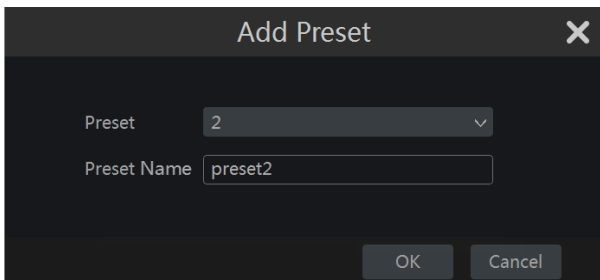
Click "Preset" to go to preset operation tab and then click "Add" to pop up a window as shown below. Select the preset and then enter the preset name in the window; finally click "OK" to save the settings. You can add 255 presets for each dome at most.





Adjust the dome's direction and then click "Save Position" to save the current preset position (you can also click another preset in the preset list and then save the preset position after adjusting the dome's direction); click  in the preset list to call the preset; click "Delete" to delete the selected preset. You can also go to preset setting interface for preset setting, see [6.2 Preset Setting](#) for details.

➤ Cruise Setting

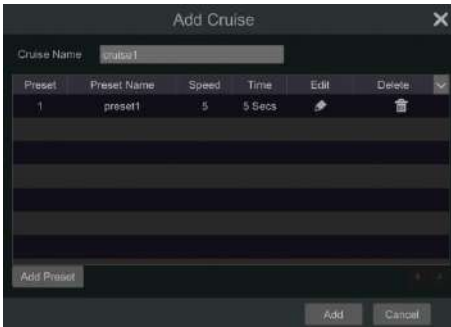
Click "Cruise" to go to cruise operation tab and then click "Add" to pop up a window as shown below left. You can add 8 cruises for each dome at most.



- ① Input the cruise name in the "Add Cruise" window and then click "Add preset" to pop up the "Add Preset" window (Before adding preset to the cruise, please add preset of the dome first).
- ② In the "Add Preset" window, select the preset name, preset time and preset speed and then click "OK".
- ③ In the "Add Cruise" window, you can click  to reselect the preset, then change the preset time and speed. Click  to delete the preset. Click "Add" to save the cruise.

Click  to start the cruise and click  to stop the cruise in the cruise list of the cruise operation tab; click "Delete" to delete the selected cruise.



You can also go to cruise setting interface for cruise setting, see [6.3 Cruise Setting](#) for details.

6.2 Preset Setting

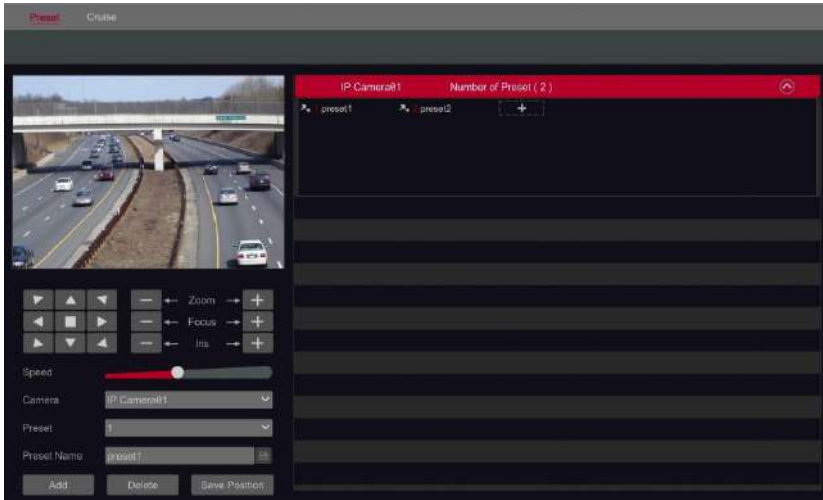
Click Start→Settings→Camera→PTZ→Preset to go to the interface as shown below.



➤ Add Preset

Select camera and then click "Add" to add preset; or click  in the camera list on the right side of the interface to display the preset information of the dome and then click  to add preset. The operations of the "Add Preset" window are similar to that of the PTZ control interface; please see [6.1 PTZ Control Interface Introduction](#) for details.

➤ Edit Preset

Select camera and preset. You can enter the new name of the preset and then click  to save the new preset name. Adjust the rotating speed, position, zoom, focus and iris of the preset and then click "Save Position" to save the preset.

➤ delete Preset

Select camera and preset and then click "Delete" to delete the preset.

6.3 Cruise Setting

Click Start→Settings→Camera→PTZ→Cruise to go to the interface as shown below.

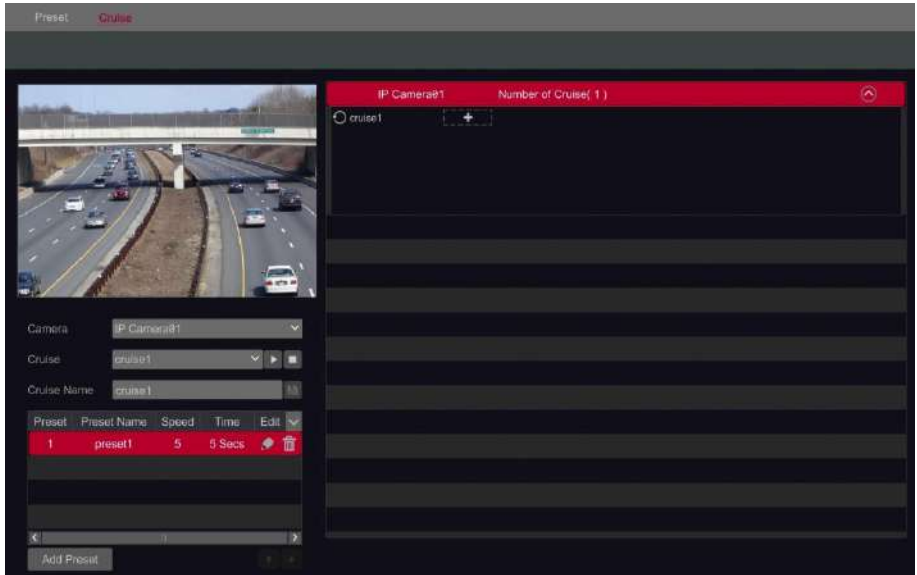

➤ Add Cruise

Click in the camera list on the right side of the interface to display the cruise information of the dome and then click to add cruise. The operations of the "Add Cruise" window are similar to that of the PTZ control interface; please see [6.1 PTZ Control Interface Introduction](#) for details.

➤ Edit Cruise

Select the camera and cruise in the "Cruise" interface. Input the new cruise name and then click to save the cruise name. Click "Add Preset" to add preset to the cruise. Click to edit the preset. Click to delete the preset from the cruise. Click one preset in the preset list and then click to move down the preset and click to move up the preset. Click to start the cruise and click to stop it.

➤ Delete Cruise



Click in the camera list on the right side of the interface to display the cruise information of the dome and then click on the top right corner of the cruise to delete the cruise.

6.4 Cruise Group Setting

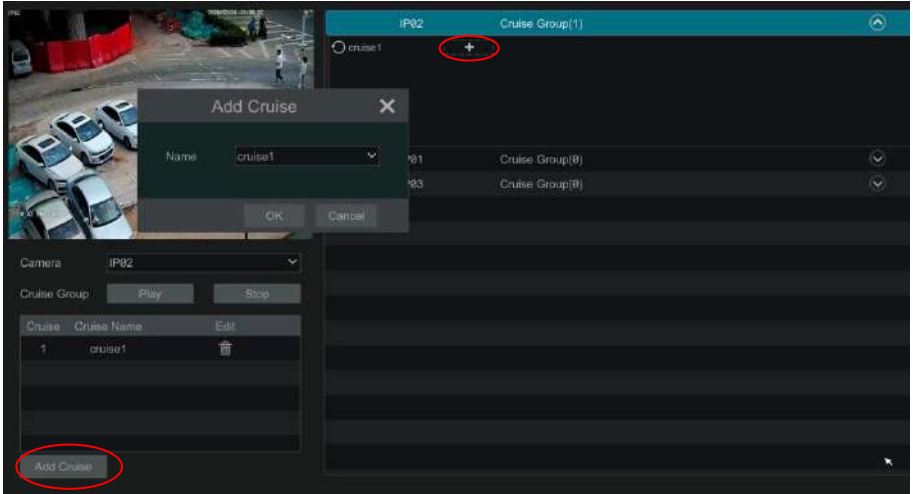
Click Start→Settings→Camera→PTZ→Cruise Group to go to the interface as shown below.



➤ Add Cruise Group

Click "Add Cruise" to add the cruise, or click  to extend the cruise list and then click  to add the cruise. After that, click "Play" on the left panel as shown below to play the cruise lines in sequence.



➤ Delete Cruise

In the cruise list, click  to delete the cruise.

6.5 Trace Settings



Click Start→Settings→Camera→PTZ→Trace to go to the interface as shown below.

➤ Trace Record

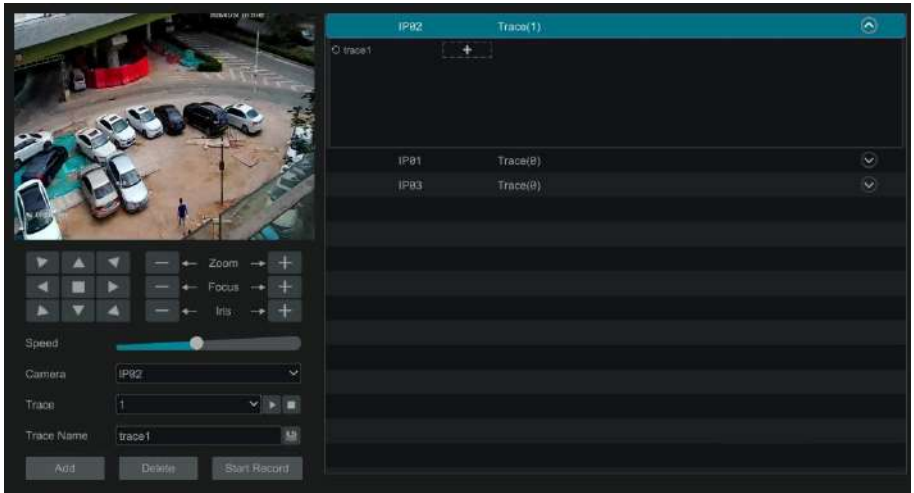
Select the PTZ camera and then click "Add" or extend the IPC information by clicking  and then click  to add a trace name. After that, click "Start Record" and move the speed dome to change its position and set its trace. Then click "Stop Record" to complete the trace record.





➤ **Play or Stop Trace**

Select the trace and click  to play the trace; click  to stop the trace.

➤ **Modify the Trace Name**

On the left panel, enter new trace name and click  to modify and save the trace name.



➤ **Delete the Trace**

Click  to delete the trace. Or put the cursor on the trace name (right panel) and then  will appear on the right corner of the trace name; click it to delete this trace.

6.6 Task Setting

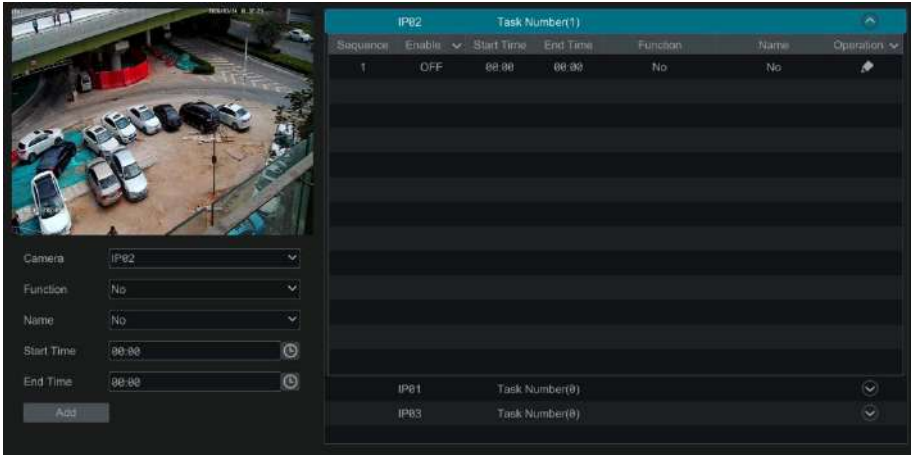
Click Start→Settings→Camera→PTZ→Task to go to the interface as shown below.



- ① Select a PTZ camera.
- ② Select function, such as preset, cruise, trace, random scanning, etc.
- ③ Select a name, such as preset name, cruise name, etc.
- ④ Select the start and end time.
- ⑤ Click "Add" to add the task.
- ⑥ Click  to extend the tasks of the PTZ camera. Click  beside "Enable" to enable the task. After the task is enabled, the PTZ camera will start the specific task at the specified time.

7 Record & Disk Management

7 Record & Disk Management

7.1 Record Configuration

7.1.1 Mode Configuration

Please format the HDDs before recording (refer to [7.5.1 Disk Management](#) for details). Click Start→Settings→Record→Mode Settings to go to the mode settings interface. You can set the record time under the “Manual Record Settings” and then click “Apply” to save the settings. There are two record modes: auto mode and manual mode.

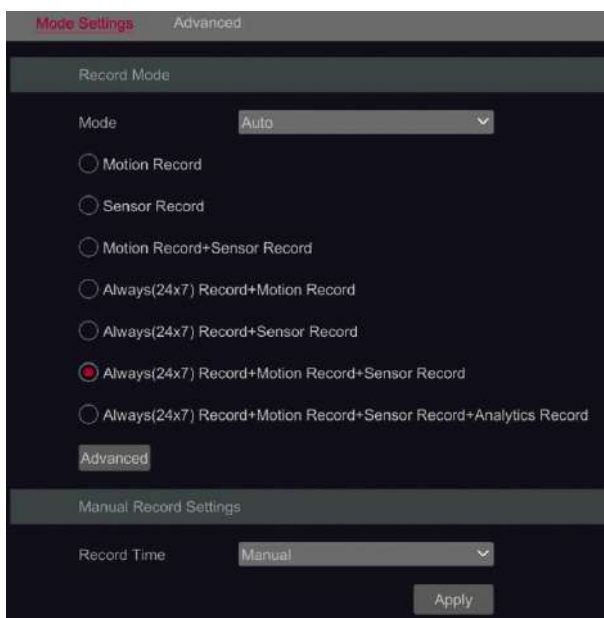

➤ Auto Mode

Motion Record: Motion alarm record will be enabled when motion alarm happens.

Sensor Record: Sensor alarm record will be enabled when sensor alarm happens.

Motion Record+Sensor Record: Motion/sensor alarm record will be enabled when motion/sensor alarm happens.

Always(24x7) Record+Motion Record: Normal record is enabled all the time; motion alarm record will be started when motion alarm happens.

Always(24x7) Record+Sensor Record: Normal record is enabled all the time; sensor alarm record will be started when sensor alarm happens.

Always(24x7) Record+Motion Record+Sensor Record: Normal record is enabled all the time; motion/sensor alarm record will be enabled when motion/sensor alarm happens.

Always(24x7) Record+ Analytics Record: Normal record is enabled all the time; analytics record will be enabled when analytics alarm happens.

You can add more auto modes on analytics record. Click "Advanced" to pop up a window as shown below. Check the modes in the window and then click "Add" to show the modes in the record mode list (in the window, the checked modes can be showed in the record mode list while the unchecked modes cannot; you shall check "**Analytics Record**").

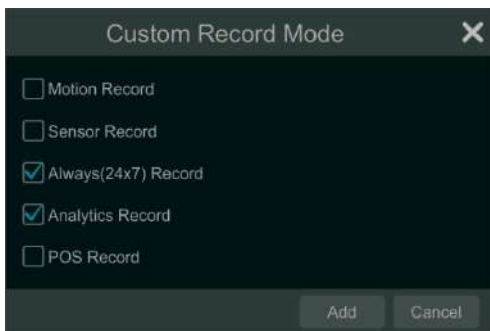

Select one auto mode to pop up the corresponding window. Set the encode, GOP, resolution, FPS, bitrate type, quality, max bitrate and audio of each camera and then click "OK" to save the settings. Please adjust the parameters according to the actual condition.



Video Encode: the available options will be H.265 and H.264 if the connected IP camera supports H.265, or the option will be H.264 only.

GOP: group of pictures.

Resolution: the higher the resolution is, the clearer the image is.

FPS: the higher the frame rate is, the more fluency the video is. However, more storage room will be taken up.

Bitrate Type: CBR and VBR are optional. CBR means that no matter how much change is seen in the video scene, the compression bitrate will be kept constant. VBR means that the compression bitrate will be adjusted according scene changes. For example, for scenes that do not have much movement, the bitrate will be kept at a lower value. This will help to optimize the network bandwidth.

Quality: When VBR is selected, you need to choose image quality. The higher the image quality you choose, the more bitrate will be required.

Max Bitrate: 32Kbps ~10240Kbps are optional.

➤ Manual Mode

If the manual mode is selected, you need to set the encode parameters and record schedules of each camera. See [7.2 Encode Parameters Setting](#) and [7.3 Schedule Setting](#) for details.

7.1.2 Advanced Configuration

Click Start→Settings→Record→Advanced to go to the following interface. Enable or disable cycle record (cycle record: the earliest record data will be replaced by the latest when the disks are full). Set the pre-alarm record time, post-alarm record time and expiration time of each camera and then click "Apply" to save the settings.

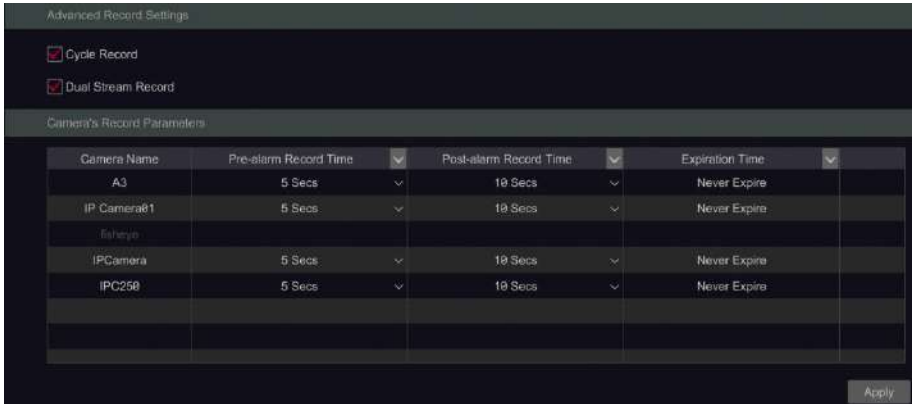

Pre-alarm Record Time: set the time to record before the actual recording begins.

Post-alarm Record Time: set the time to record after the actual recording is finished. **Expiration Time:** set the expiration time for recorded video. If the set date is overdue, the recorded data will be deleted automatically.

7.2 Encode Parameters Setting

Click Start→Settings→Record→Encode Parameters to go to the interface as shown below. Set the encode, resolution, FPS, GOP, bitrate type, quality, max bitrate and audio of main stream for each camera in "Event Recording Settings" and "Schedule Recording Settings" interfaces. Click "Apply" to save the settings. You can set the record stream of each camera one by one or batch set them for all cameras.

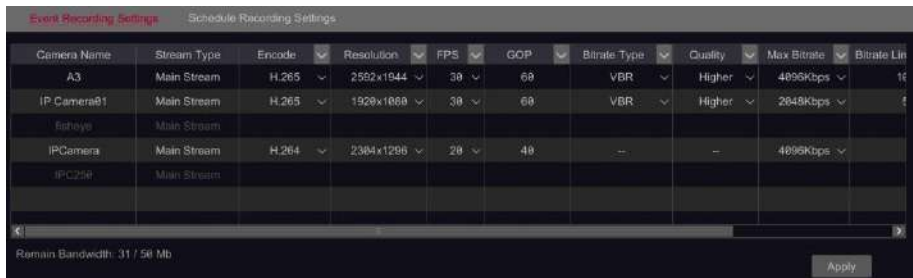

Click Start→Settings→Record→Stream Settings to go to "Sub-stream" interface. Set the encode, resolution, FPS, GOP, bitrate type, quality and max bitrate of sub-stream for each camera in the interface and then click "Apply" to save the settings.

Camera Name	Stream Type	Encode	Resolution	FPS	GOP	Bitrate Type	Quality	Max Bitrate
A3	Sub Stream	H.265	704x480	10	20	VBR	Higher	512Kbps
IP Camera#1	Sub Stream	H.265	704x480	30	60	VBR	Higher	512Kbps
IPCamera	Sub Stream	H.264	704x480	20	40	--	--	768Kbps

7.3 Schedule Setting



7.3.1 Add Schedule

Click Start→Settings→Record→Record Schedule→Edit Schedules to go to the interface as shown below. "24x7", "24x5" and "24x2" are the default schedules; you cannot edit or delete "24x7" while "24x5" and "24x2" can be edited and deleted. Click the schedule name to display the detailed schedule information on the left side of the interface. The seven rows stand for the seven days in a week and each row stands for 24 hours in a day. Blue stands for the selected time and gray stands for unselected time.

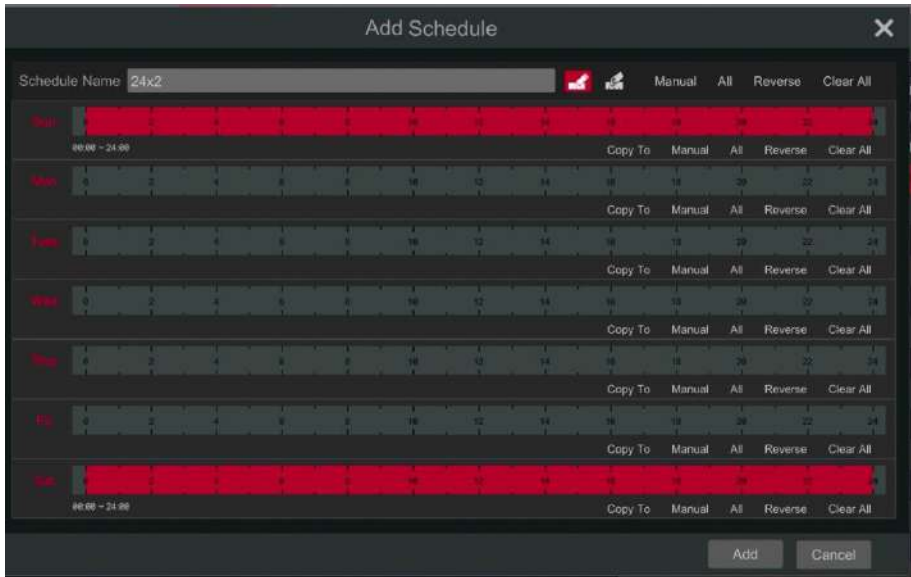

Name	Edit	Delete
24x7		
24x5		
24x2		



Click  to add a new schedule. Refer to the picture below.



Set the schedule name and schedule time and then click "Add" to save the schedule. You can set day schedule or week schedule.  : add button;  : delete button.

➤ Set Day Schedule

Click  and then drag the cursor on the time scale to set record time; click  and then drag the cursor on the time scale to delete the selected area.

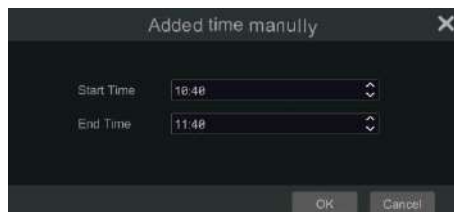

You can manually set the record start time and end time. Click  or  and then click "Manual" on each day to pop up a window as shown below. Set the start and end time in the window and then click "OK" to save the settings.

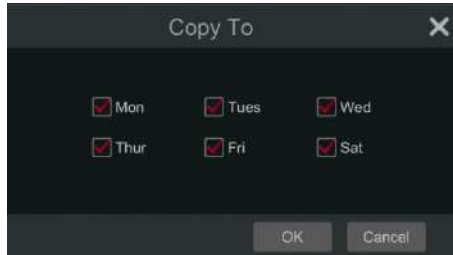

Click "All" to set all day recording; click "Reverse" to swap the selected and unselected time in a day; click "Clear All" to clear all the selected area in a day. Click "Copy To" to copy the schedule of the day to other days. Refer to the picture below. Check the days in the window and then click "OK" to save the settings.



➤ Set Week Schedule

Click  or  and then click "Manual" beside  to set the week schedule. Refer to the picture below. Set the start and end time, check the days in the window and then click "OK" to save the settings.

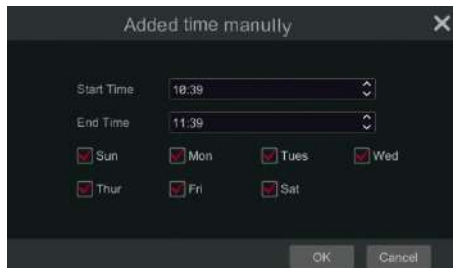



Click "All" to set all week recording; click "Reverse" to swap the selected and unselected time in a week; click "Clear All" to clear all the selected area in a week.

7.3.2 Record Schedule Configuration

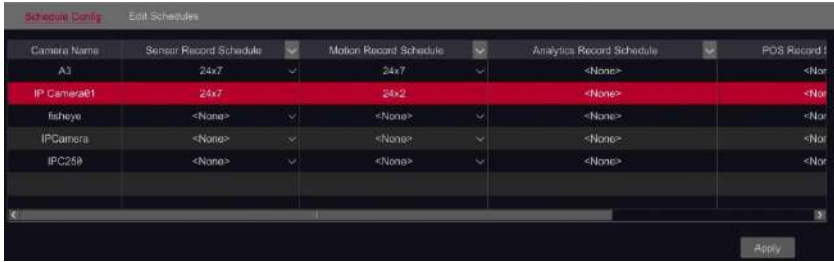
Click Start→Settings→Record→Record Schedule→Schedule Configuration to go to the interface as shown below. Set the schedule of sensor record, motion record, timed record and intelligence record. Click "None" in the drop-down menu to clear the schedule. Click "Apply" to save the settings.



Go to “Edit Schedules” interface and then  click to edit the schedule. The settings of “Edit Schedule” are similar to that of the “Add Schedule”. Click  to delete the schedule.

7.4 Record Mode

7.4.1 Manual Recording

Method One: Click  on the tool bar at the bottom of the live preview interface to enable recording of the camera.

Method Two: Go to live preview interface and then click the right-click menu “Manually Record On” in the camera window or click  on the tool bar under the camera window to start recording.

Note: Click Start → Settings → Record → Mode Settings and then set the manual record time in the interface. Click “Apply” to save the settings.

7.4.2 Timing Recording

Timing Recording: the system will record automatically according to the schedule. Set the timing record schedule of each camera. See [7.3 Schedule Setting](#) for details.

7.4.3 Motion Based Recording

Motion Based Recording: the system will start motion based recording when the motion object appears in the setup schedule. The setup steps are as follows:

- ① Set the motion based recording schedule of each camera. See [7.3 Schedule Setting](#) for details.
- ② Enable the motion and set the motion area of each camera. See [11.2.1 Motion Configuration](#) for details.

The camera will start motion based recording once you finish the above settings.

7.4.4 Sensor Based Recording

- ① Set the sensor based recording schedule of each camera. See [7.3 Schedule Setting](#) for details.
- ② Set the NO/NC type of the sensor, enable the sensor alarm and then check and configure the "Record". See [11.1 Sensor Alarm](#) for details.

7.4.5 Intelligence Recording

- ① Set the intelligence recording schedule of each IP camera. See [7.3 Schedule Setting](#) for details.
- ② Enable the intelligence detection (object detection, exception, tripwire, intrusion or face detection) and draw alert surface or warning area of each IP camera. See [9 AI Event Management](#) for details.

The camera will start intelligence recording once you finish the above settings. This function is only available for some IPCs.

7.5 Disk

7.5.1 Disk Management

➤ Disk Management

Click Start→Settings→Disk→Disk Management to go to disk management interface. You can view the NVR's disk number and disk status and so on in the interface. Click "Formatting" to format the HDD.

Disk	Capacity[GB]	Free Space[GB]	Disk Serial No.	Disk Model	Status	Type	Record Period	Operation
Disk1	232	209	6RYD8VBF	ST3250310AS	RW	Ordinary Pl...	10/22/2018-10/23/2018	Format

The settings of RAID are as followings. Please skip the settings of physical disk, array and disk mode if the NVR doesn't support this function.

➤ Physical Disk

Click Start→Settings→Disk→Disk Management→Physical Disk to go to physical disk interface.

- ① Click disks and then click "Create an array" to create arrays (You shall enter username and password again to authenticate the authority before creating an array).
- ② Select the RAID level which including RAID0, RAID1, RAID5, RAID6 and RAID10 in the popup window.
- ③ Select physical and global hot spares. The user can also check the array capacity.
- ④ Click "Add" to add the array.

After creating the array successfully, the user can check the information of the array and physical disk in disk management interface.

➤ **Array**

Click Start→Settings→Disk→Disk Management→Array to go to array interface. Check the information of the disk. The user can also rebuild and delete the array.

➤ **Disk Mode**

Click Start→Settings→Disk→Disk Management→Disk Mode to go to disk mode interface. Click "Enable RAID" and save the settings.

Note: 1. The new HDD should be formatted for normal use.

2. For normal use of the HDD which has been used in other NVR, if the NVR is of the same model with the new NVR, please import the configuration file of the NVR to the new NVR or format the HDD; if the models of the two NVRs are different, please format the HDD.

7.5.2 Storage Mode Configuration

Click Start→Settings→Disk→Storage Mode to go to the interface as shown below.

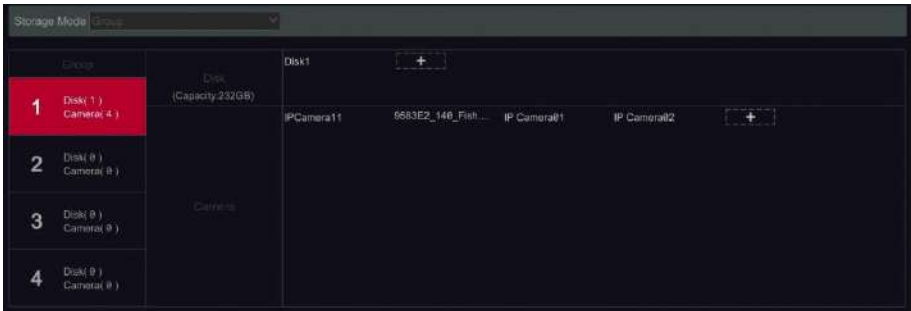

There are all four disk groups. By using disk group, you can correspond the camera to disk (the record data of the camera in the group will be stored into the disks in the same group). The NVR with e-SATA interface supports e-SATA recording.

The added disks and cameras will be added into group one automatically. The disks and cameras in the groups can be deleted except group one (select a disk group and then click  on the top right corner of the added disk or camera to delete it from the group). The deleted disks and cameras will be moved into group one automatically.

Each group can add the disks and cameras from other groups. Each disk and camera can only be added into one group. Select a disk group and then click  in the disk or camera row to pop up a window. Check the disks or cameras in the window and then click "Add".

7.5.3 View Disk and S.M.A.R.T. Information

Click Start→Settings→Disk→View Disk Information to view the HDD information; click "S.M.A.R.T. Information" to view the working status of the HDD. Refer to the picture below.

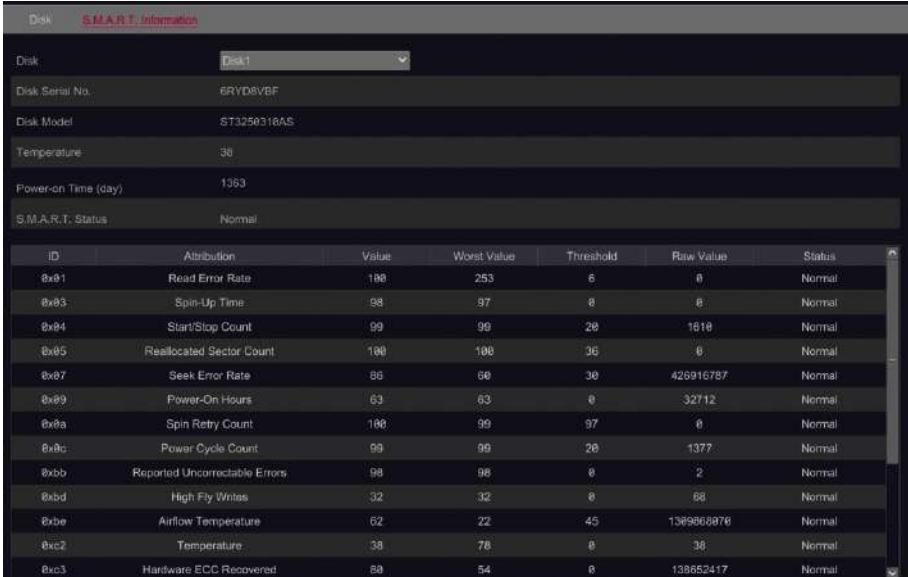



The screenshot shows the Windows Disk Management application with the S.M.A.R.T. Information window open for Disk1. The window displays various disk attributes and their S.M.A.R.T. status.

ID	Attribution	Value	Worst Value	Threshold	Raw Value	Status
0x01	Read Error Rate	100	253	6	0	Normal
0x03	Spin-Up Time	98	97	8	0	Normal
0x04	Start/Stop Count	99	99	20	1610	Normal
0x05	Reallocated Sector Count	100	100	36	0	Normal
0x07	Seek Error Rate	86	60	30	426916787	Normal
0x09	Power-On Hours	63	63	0	32712	Normal
0x0a	Spin Retry Count	100	99	97	0	Normal
0x0c	Power Cycle Count	99	99	20	1377	Normal
0xbb	Reported Uncorrectable Errors	98	98	0	2	Normal
0xbd	High Fly Writes	32	32	0	68	Normal
0xbe	Airflow Temperature	62	22	45	1309060970	Normal
0xc2	Temperature	38	70	0	38	Normal
0xc3	Hardware ECC Recovered	80	54	0	130852417	Normal



8 Playback & Backup

8.1 Instant Playback

Click  on the tool bar at the bottom of the preview camera window to play back the record (click  on the tool bar at the bottom of the live preview interface to set the default playback time). Refer to the picture below. Drag the playback progress bar to change the playback time. You can also click the right-click menu "Instant Playback" in the camera window and then set the instant playback time to play back the record.



8.2 Playback Interface Introduction



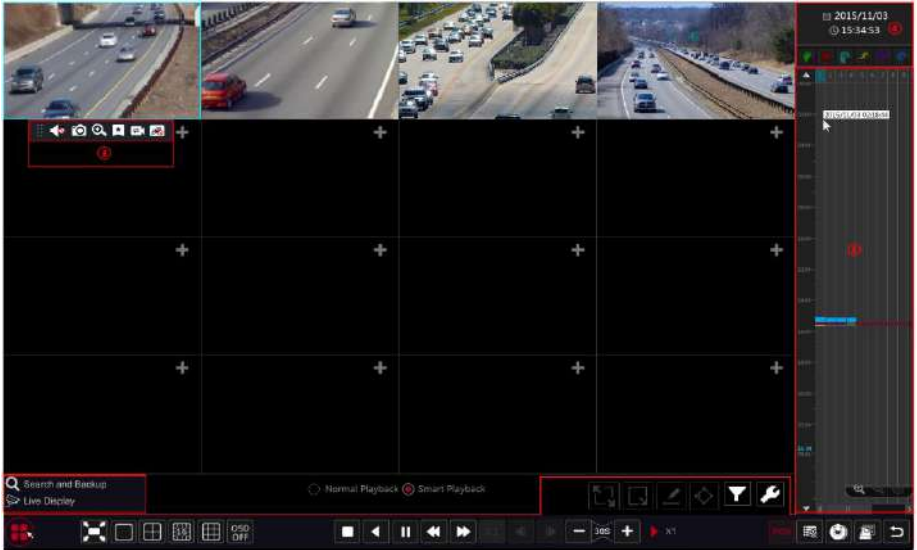













Click  on the tool bar at the bottom of the live preview interface or click Start→Playback to go to the playback interface as shown below (click  on the tool bar at the bottom of the live preview interface to set the default playback time).



The added cameras will playback their records in the playback interface automatically. You can also add the playback camera manually. Click **+** in the playback window to pop up the “Add Camera” window. Check the cameras in the window and then click “Add” to add playback camera. The system supports a maximum of 16 synchronous playback cameras.

The buttons on the tool bar (area ①) at the bottom of the playback interface are introduced in the table below.



Button	Meaning
	Start button. Click it to pop up area ②.
	Full screen button. Click it to show full screen; click it again to exit the full screen.
	Screen mode button.
	OSD ON button. Click it to enable OSD; click to disable OSD.
	Stop button.
	Rewind button. Click it to play video backward.
	Play button. Click it to play video forward.
	Pause button.
	Deceleration button. Click it to decrease the playing speed.
	Acceleration button. Click it to increase the playing speed.



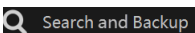
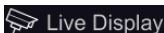





Button	Meaning
	Previous frame button. It works only when the forward playing is paused in single screen mode.
	Next frame button. It works only when the forward playing is paused in single screen mode.
	Click  to step backward 30s and click  to step forward 30s.
	Open/close POS information.
	Event list/tag button. Click it to view the event record of manual/schedule/sensor/ motion and the tag information.
	Backup button. Drag the mouse on the time scale to select the time periods and cameras, and then click the button to back up the record.
	Backup status button. Click it to view the backup status.
	Back button. Click it to return.
	Full screen motion button.
	Draw rectangle. You can search the record of motion detection in the pre-defined rectangular area.
	Draw line. You can search the record of crossing the line after drawing the line.
	Draw quadrilateral. You can search the record in this quadrilateral after drawing it.
	Select face button. Click it to select face. (only available for some models)
	Smart playback settings. Click it to set smart playback.

Note: Some models may not support face search and face smart playback. Introduction of area ②:











Button	Meaning
	Click it to go to record search and backup interface; see 8.4 Record Search, Playback & Backup for details.
	Click it to go to live preview interface; see Chapter 5 Live Preview Introduction for details.

Click on the playback window to show the tool bar as shown in area ③; right click on the window to show the menu list. The tool bar and menu list are introduced in the table below.





Button	Menu List	Meaning
	--	Move tool. Click it to move the tool bar anywhere.
	Enable Audio	Click it to enable audio. You can listen to the camera audio by enabling audio.
	Snap	Click it to snap.

	<p>Zoom In</p>	<p>Click it to go to the zoom in interface. The zoom in interface is similar to that of the camera window in the live preview interface. Click  to pause the record playing; click  to play the record. When the record is paused in forward playing mode, you can click  to view the previous frame and click  to view the next frame.</p>
	<p>Add Tag</p>	<p>Click it to add tag. You can play back the record by searching the added tag. Click it and then enter the tag name in the popup window. Click "Add" to add tag.</p>
	<p>Switch Camera</p>	<p>Click it to switch the playback camera. Click it and then check the camera in the popup window. Click "OK" to change the camera.</p>
	<p>Close Camera</p>	<p>Click it to close the playback camera.</p>

Introduction of area ④:

Click  to set the date; click  to set the time and then the playback camera will play the record from the time you set. You can check the record type as required for record playback; first you should click  on the tool bar at the bottom of the interface to clear all the playback camera, then check the record type (: manual record; : sensor based record; : motion based record; : schedule record; : intelligence record; : POS record) and finally click  in the playback window to add camera for playback (the record time scale will show the record data of the checked record type only after the above operations).

Introduction of the record time scale (area ⑤):

A tool bar will appear after moving the mouse to the record time scale. Click  /  to zoom the timeline; click  to recover the timeline to 24 hours' ratio. Drag the timeline or slide the scroll wheel of the mouse on the time scale to show the hidden time on the top or bottom of the timeline. You can also click  to show the hidden time on the top of the timeline or click  to show the hidden time on the bottom of the timeline. Drag the slider at the bottom of the time scale to show the hidden playback cameras.

The record time scale shows different record types with different colors. The green block stands for manual record, red block stands for sensor based record, yellow block stands for motion based record, blue block stands for schedule record and cyan block stands for intelligence record. Click the record block to set the time and then the playback camera will play the record from the time you set.

Drag the color block on the time scale to select the backup area and then right click the area or click  to pop up a backup information window. Click the "Backup" button in the window to pop up the backup window. Select the device, backup path and backup format and then click the "Backup" button to start the backup.

8.3 Smart Playback

8.3.1 Smart Playback Settings

Click  to go to the following interface. Set the value of "Speed of non-interest video" (Please skip this one if you click "Skip non-interest video"), "Speed of interest video" and "Intrusion Percentage".

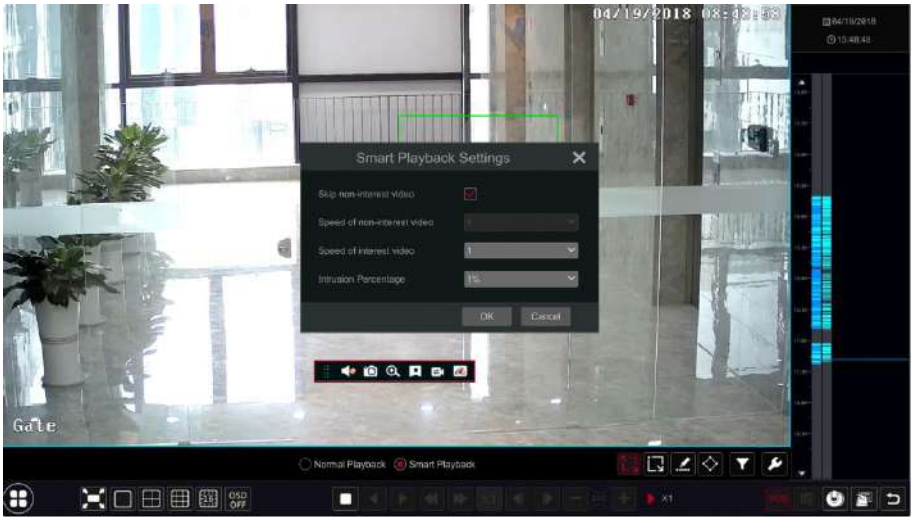

8.3.2 Smart Playback Based on Motion Detection

- **Smart Playback by Drawing Grid**

Click  and draw a rectangle in the desired area. Then the system will automatically search the record files of this area. The cyan blocks indicate that there are intelligent recording files. Move the cursor to such block and click to play the record.



- **Smart Playback by Drawing Grid**

Click  and draw a line in the desired area. Then the system will automatically search the record files about crossing this line. The cyan blocks indicate that there are intelligent recording files. Move the cursor to such block and click to play the record.



- **Smart Playback by Drawing Quadrilateral**

Click  and draw a quadrangle in the desired area. Then the system will automatically search the record files of this area. The cyan blocks indicate that there are intelligent recording files. Move the cursor to such block and click to play the record.



8.3.3 Smart Playback by Face Search

Before starting this function, the face recognition function shall be enabled. Please see Face Recognition for details. If your device doesn't support such function, please skip the following instructions.

- ① In the smart playback interface, click  to pop up the following window.

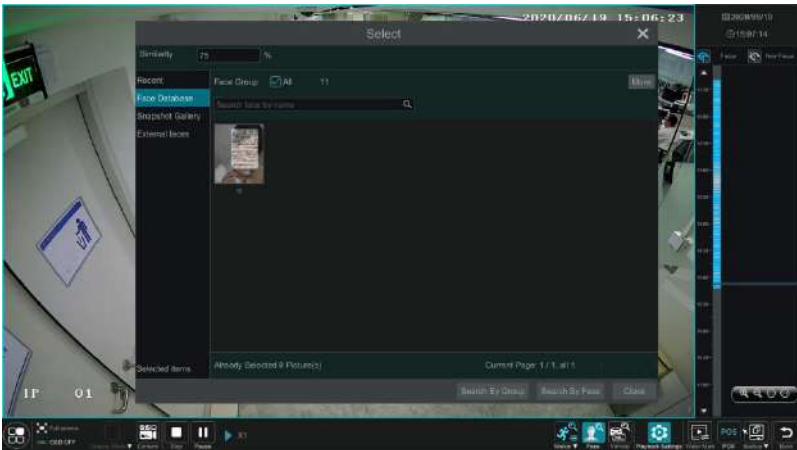

- ① Set similarity. The higher the sensitivity value is, the lower the searching accuracy is, and vice versa.
- ② Select targets. You can select targets from recent, face database, snapshot gallery or external faces.
- ③ Select search mode. There are two search modes: search by group and search by face. Search by group: Choose "Face Database" and then click "More" to choose one or more groups.

Move the cursor to the time block where the record exists and click to play those records.

8.3.4 Smart Search by License Plate

Before starting smart search by plates, please add ANPR cameras first and enable the LPR function. Please refer to License Plate Recognition for details.

Click  button to go to the following interface.

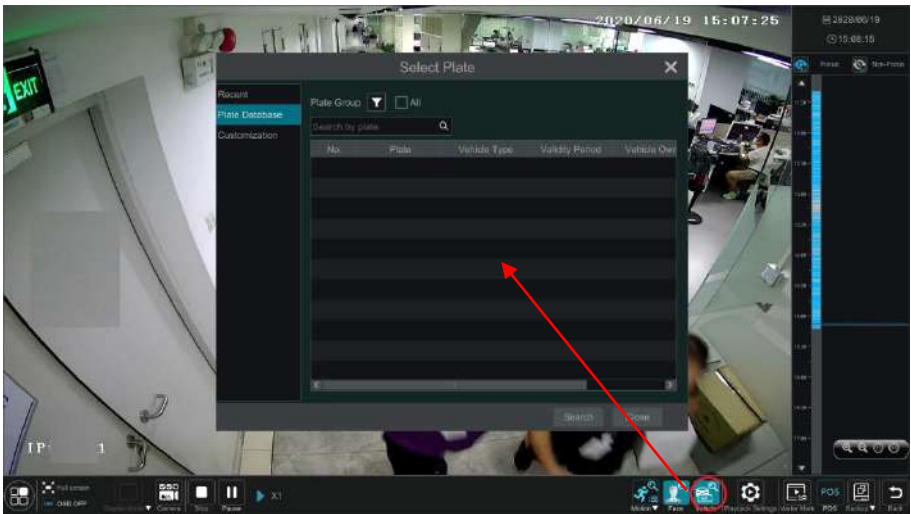

Select the plate from "Recent", "Plate Database" or "Customization" and then click "Search" to search recorded files and play. Here we take an example of search plate from "Plate Database".

Click  to choose a group. Then plates will be listed in the table automatically. Click "Search" to play.



8.4 Record Search, Playback & Backup

The record data and the snapped pictures can be backed up through network, USB (U disk or USB mobile HDD) or e-SATA (only available for some models).

The file system of the backup devices should be FAT32 format.

8.4.1 Search, Playback & Backup by Time-sliced Image

① Click Start→Search and Backup→By Time-sliced Image to go to "By Time-sliced Image" tab. There are two view modes: by time and by camera. In the time view mode, a maximum of 64 camera thumbnails can be showed. If the camera thumbnail number is more than 64, the cameras will be listed directly by their camera name, not the thumbnail. A maximum of 196 camera names can be listed. If the camera name number is more than 196, the time view mode will be disabled and the camera view mode will be available only.

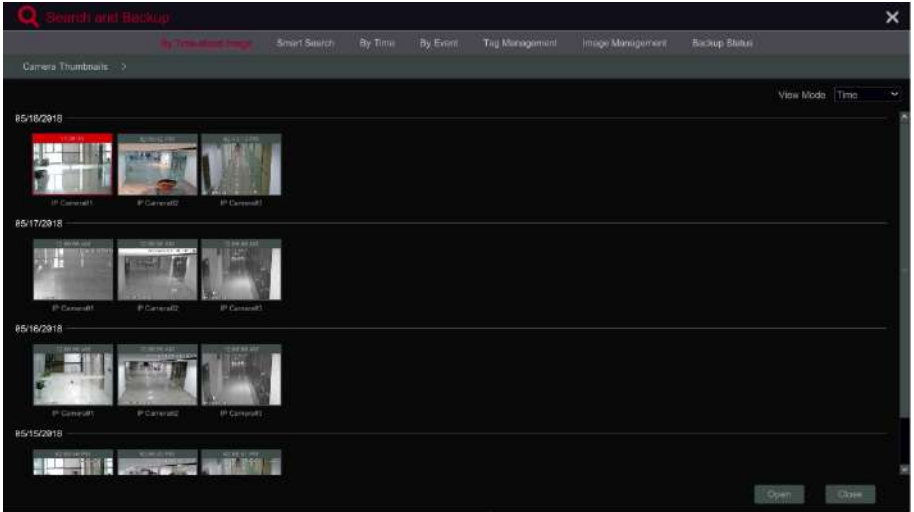

- ② Select one camera in the interface and then click the “Open” button.
- ③ Click the image box to play the record in the small playback box on the left side of the interface (the box which has image inside indicates that the record data exist).
- ④ Refer to the picture below. Drag the color blocks on the time scale to select the record data and then click the “Backup” button to pop up the “Record Backup” window as shown below. Select the device name, backup format and path and then click the “Backup” button to start the backup.



Note: If you back up the record in private format, the system will back up a RPAS player to USB device automatically. The private format record can be played by RPAS player only.

- Click "Playback" to play the record in the playback interface (refer to 8.2 Playback Interface Introduction for details). Click "Close" to close the interface.

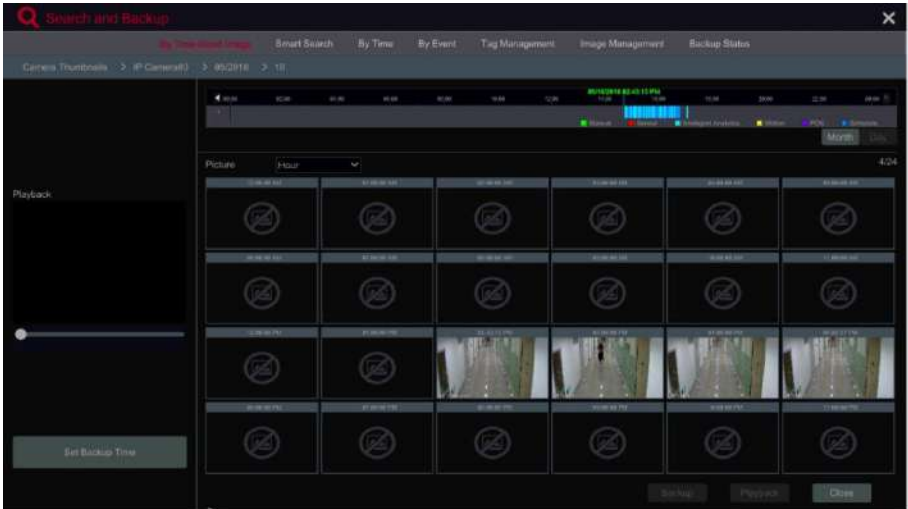

Time Slice Mode Selecting:

Method One: Click "Year", "Month" or "Day" button under the record time scale to select the time slice mode. In "Day" mode, click ◀ / ▶ on the left/right side of the time scale to view the record of the last/next day; click "Minute" in the "Picture" option under the time scale to select "Minute" mode (in "Minute" mode, click the time scale to change the time of the 60 display windows) and click "Hour" to select "Hour" mode.

Method Two: Click ▶ beside "Camera Thumbnail" on the left top corner of the interface to select the time slice mode.

Method Three: Right-click the mouse on any area of the time-sliced interface to go back to the upper interface.

8.4.2 Smart Search

Smart Playback by Drawing Grid

- ① Click Start→Search and Backup→Smart Search to go to “Smart Search” tab as shown below. Behavior Detection: when you select the smart playback mode, the system will analyze the video including the motion detection, tripwire and intrusion detection.
- ② Click “Behavior”. Set the searching time period and you will search the channel which has the intelligence detection record.
- ③ Check the channel and select the smart playback.
- ④ Set the backup time and select the channel to backup.



 : Smart playback settings button. Click it to set intrusion percentage.

 : Full screen motion button.

 : Motion button.

 : Draw line button. You can search the record of crossing the line after drawing the line.

 : Draw quadrilateral. You can search the record in this quadrilateral after drawing it.

8.4.3 Search, Playback & Backup by Time

- ① Click Start→Search and Backup→By Time to go to “By Time” tab as shown below.
- ② Click **+** on the bottom of the interface to add playback camera. A maximum of 16 cameras can be added for playback. Click “Modify” on the top right corner of the camera window to change the camera and click “Clear” to remove the camera.
- ③ Click the camera window to play the record in the small playback box on the left side of the interface. You can set the date on the top left of the interface, check the event type as required and click the time scale or click **🕒** under the time scale to set the time. The camera window will play the record according to the time and event type you set.
- ④ Drag the color blocks on the time scale to select the record data (or click “Set Backup Time” on the bottom left corner of the interface to set the backup start time and end time) and then click “Backup” for record backup. Click “Playback” to play the record in the playback interface.

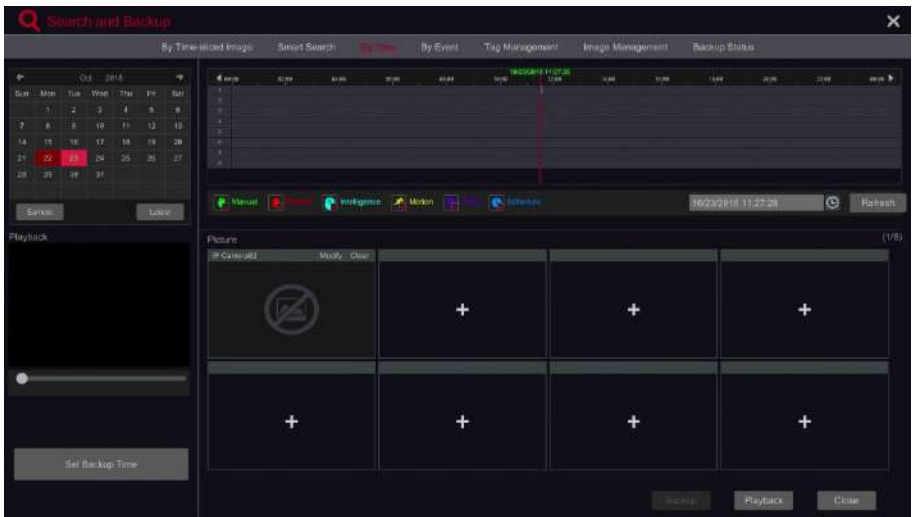



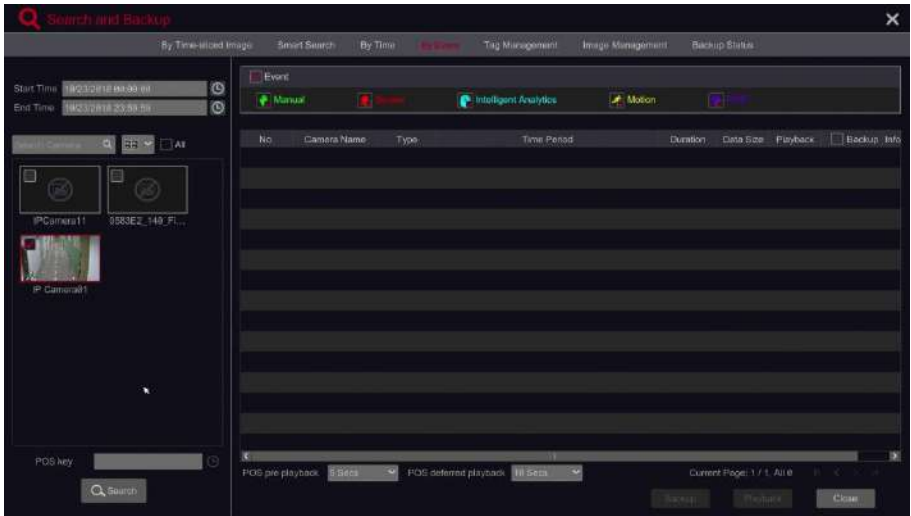

8.4.4 Search, Playback & Backup by Event

Some models may support searching POS event.

- ① Click Start→Search and Backup→By Event to go to “By Event” tab as shown below.





- ② Check the event type in the interface as required.
- ③ Click  to set the start time and end time on the top left of the interface.
- ④ Check cameras on the left side of the interface or check "All" to select all the cameras and then click  to search the record. The searched record will be displayed in the list.
- ⑤ Click  in the list to play back the record in the popup window. Click  to back up one record data or check multiple record data in the list and then click "Backup" for record batch backup.
- ⑥ Select one record data in the list and then click "Playback" to play the record in the playback interface.

8.4.5 Search & Playback by Tag

Only if you add the tags can you play the record by tag search. Click Start→Playback to go to the playback interface and then click  on the bottom of the camera window to add tag when you want to mark the playback time point of the selected camera.

Click Start→Search and Backup→Tag Management to go to "Tag Management" tab.











Click  in the interface to play the record. Click  to edit the tag name. Click  to delete the tag.

8.4.6 Image Management

Click Start→Search and Backup→Image Management to go to “Image Management” tab. The system will display all the snapped images automatically in the list.



Click  to delete the image. Click  to pop up the “Export” window. Select the device name and save path in the window and then click the “Save” button. Click  to pop up the “View Image” window. Click  to export the image. Click  to view the previous image; click  to view the next image; click  to delete the image; click  to play all the images.

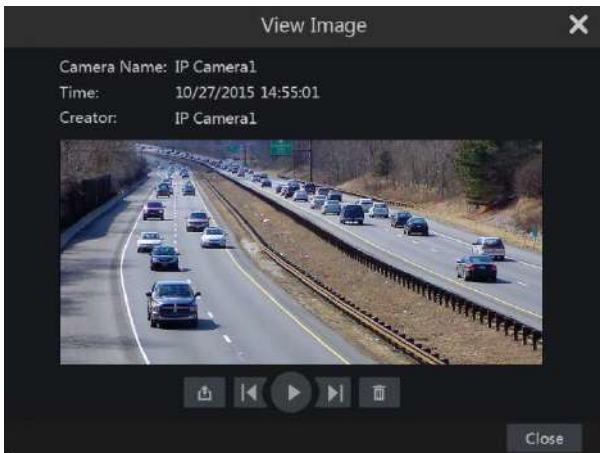

8.4.7 View Backup Status

Click Start→Search and Backup→Backup Status or click  on the tool bar at the bottom of the playback interface to view the backup status.

9 AI Event Management

9 AI Event Management

9.1 Face Recognition

Only some models support alarm based on face match. If your device doesn't support face recognition function, please skip the face database and face recognition instructions.

Please set face recognition function according to the following procedures for the first time.

Set face detection and alarm linkage→Add face group→Add faces to the face group→Enable and set successful recognition (or stranger)→Set successful recognition (or stranger) alarm linkage

9.1.1 Face Detection Settings

Face Detection: Alarms will be triggered if someone intrudes into the pre-defined alarm areas.

① Click Start→Settings→AI/Event→AI Event→Face Recognition→Detection to go to the following interface.

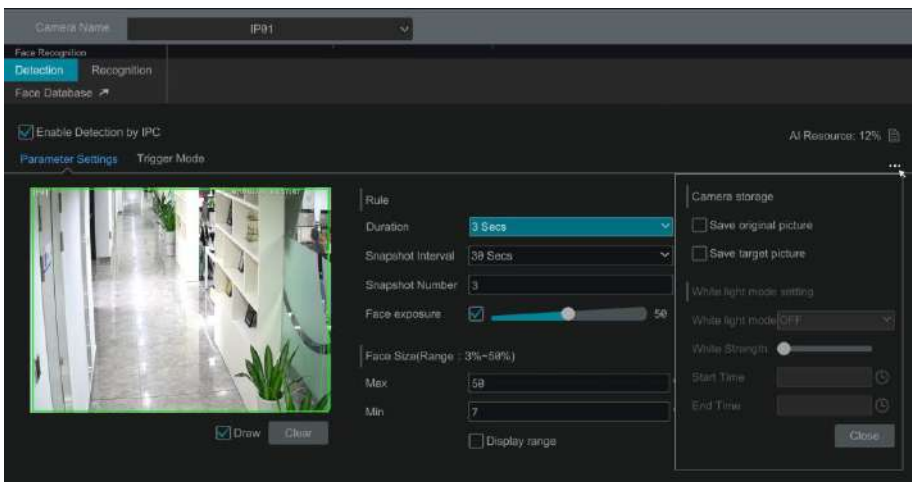

- ② Select the camera, check "Enable Detection by IPC" and set the duration.
Note: Some models may support face detection by NVR. For these models, the camera without AI function also can be added and used to detect faces through NVR. But if face detection by NVR is enabled for one camera (without AI), the people/vehicle perimeter detection cannot be enabled simultaneously, and vice-versa.
- ③ Set the snapshot interval and snapshot number. The snapshot interval refers to the time interval that the camera captures the same face during its continuous tracking period. The snapshot number refers to the picture number of the same face captured during its continuous tracking period (For example: the snapshot interval is set to "30 seconds" and the snapshot number is set to "3"; then the camera will capture the same face once every 30 seconds and it will capture this face 3 times at most during its continuous tracking period).
- ④ Enable face match exposure as need. When the brightness of the captured face is not enough, it can be enabled. (Only some IPCs support this function)
- ⑤ Set the alarm area. Click "Draw" and then drag the mouse to draw a detection area. Click "Clear" to delete the alarm area. Then set the detectable face size by defining the maximum value and the minimum value (The default size range of a single face image occupies from 3% to 50%of the entire image).

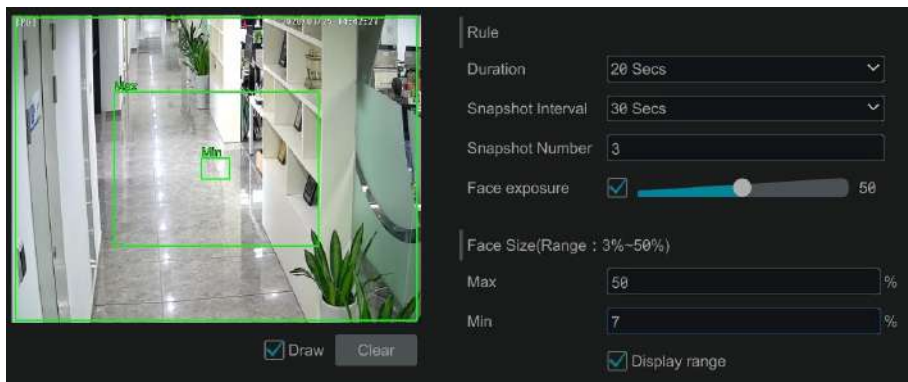

- ⑥ Enable "Save Source Information" or/and "Save Face Information" as needed. If enabled, the system will automatically save the corresponding images on the SD card. For the models with LED light, white light mode also can be set.
- ⑦ Click "Apply" to save the settings.
- ⑧ Click "Trigger Mode" to go to face detection alarm linkage setting interface:



Face Detection Alarm Linkage Configuration:

- Trigger "Record", "Snapshot", "Push", "Alarm-out", "Preset", "Buzzer", "Pop-up Video" and "E-mail" as needed.

Record: Click the "Configure" button to pop up the window. Select camera on the left side and then click to set the camera as the trigger camera. Select trigger camera on the right side and then click to cancel the trigger camera. Click "OK" to save the settings. The trigger cameras will record automatically when faces are detected.

Alarm-out: Click the "Configure" button to pop up the window. Then the "Trigger Alarm-out" window will pop up automatically. Configure the trigger alarm-out in the window. The system will trigger the alarm-out automatically when faces are detected. You need to set the delay time and the schedule of the alarm outputs. See [11.5.1 Alarm-out](#) for details.

Preset: Click and then select the preset for each camera. To add presets, please see [6.2 Preset Setting](#) for details.

Snapshot: check it. The current camera will capture images automatically when faces are detected.

Push: If it is enabled, the system will send messages when faces are detected.

Buzzer: if it is enabled, the system will begin to buzz when faces are detected. To set the delay time of the buzzer, please see [11.5.4 Buzzer](#) for details.

Pop-up Video: if it is enabled, the system will pop up the corresponding video automatically when faces are detected. To set the duration time of the video, please see [11.5.3 Display](#) for details.

E-mail: if it is enabled, the system will send an e-mail when faces are detected. Before you enable the email, please configure the recipient's e-mail address first (see [13.1.5 E-mail Configuration](#) for details).

Enable "IPC_Audio" or "IPC_Light" as needed (only some IPCs support these two functions). To set the IPC voice and its times and volume, please refer to [11.5.6 Audio](#) for details. To set the light flashing time and frequency of the IPC, please refer to [11.5.7 Light](#) for details.

- ⑨ Click "Apply" to save the settings.

9.1.2 Face Database Management

① Click Start→Settings→AI/Event→AI Event→Face Recognition→Face Database to go to the following interface as shown below.

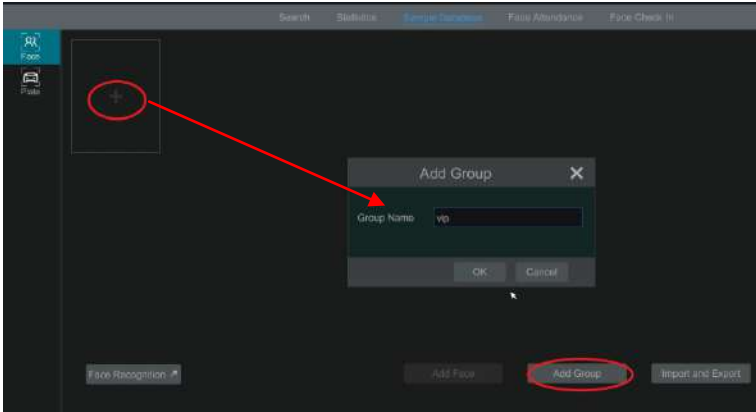

For the first time, you can click "+" or "Add Group" to add groups.

② To add targets for each group.

- Select a list and then click to expand the list as shown below.

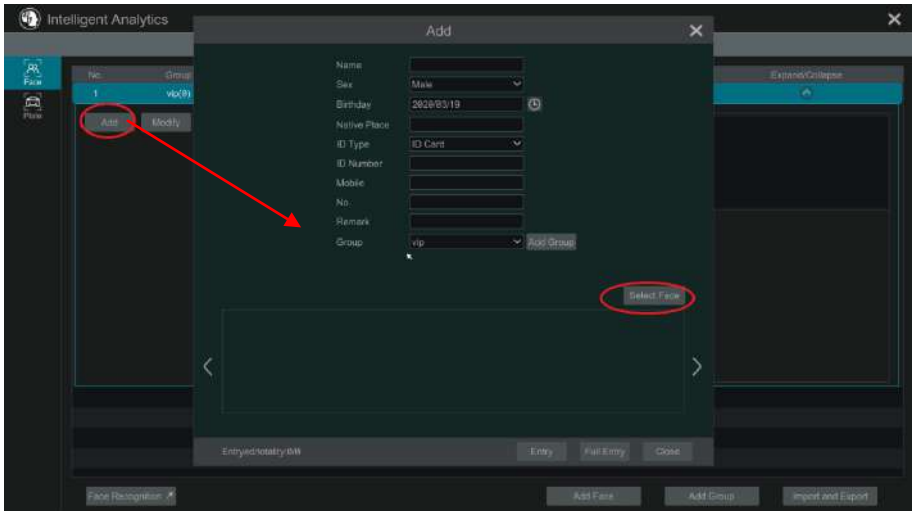

- Click "Add" and then click "Select Face" to add face images. You can add faces from snapshot gallery or external faces.

Adding faces from snapshot gallery: Select search time or self define the search time and then click "Search" to search target faces. Then select the desired faces and click "Select".

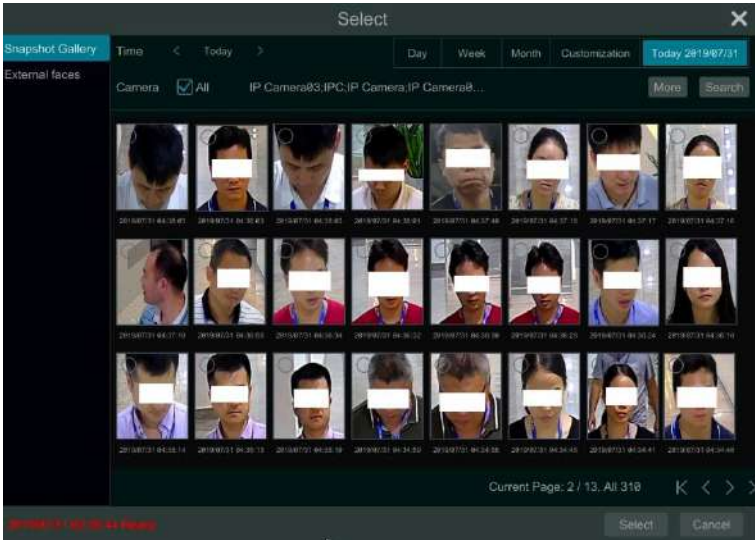

Add external faces

Save the face pictures in your USB storage device and then insert the USB storage device into the USB port of the NVR.

Go to the face database interface. Click to expand the group and then click "Add". Select "External faces" to select face pictures. You can select one face to add or multiple faces to add. To add multiple faces: a. put face pictures and the description file (.csv or .txt) to one specific folder (please edit the detailed descriptions of these pictures according to the personal information description); b. click "All" to select all face pictures; c. click "Full Entry".

Note: the added image must be less than 70KB and the image format shall be ".jpg" and ".jp"

- After that, add the corresponding information, like name, gender, birthday, ID number, phone number and so on.

Having saved the target image, click the image and then the detailed information will be listed on the right.

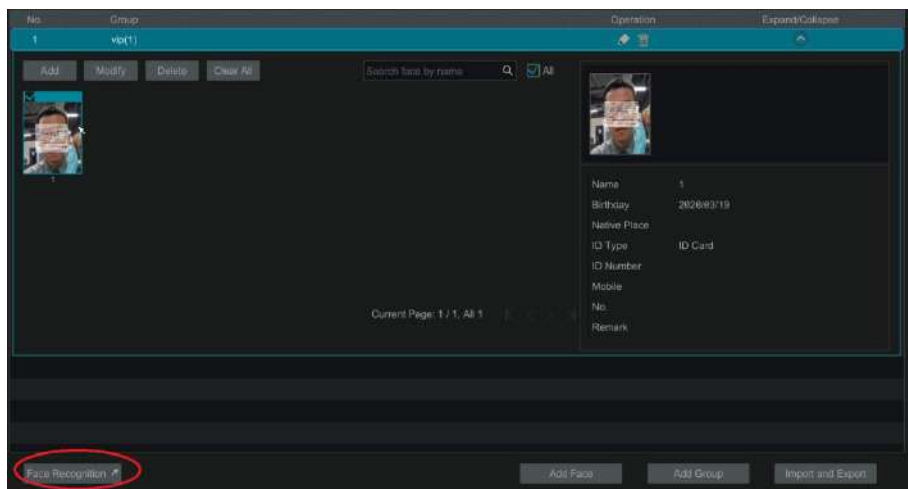

- Import and Export Face database
Insert your mobile storage device into the USB interface of the NVR and then click "Import and Export" to import or export the face database settings.

9.1.3 Face Recognition Settings

After the face database and face pictures are added, click "Face Recognition" to return to the face recognition setting interface. Click the "Recognition" tab to go to the following interface.

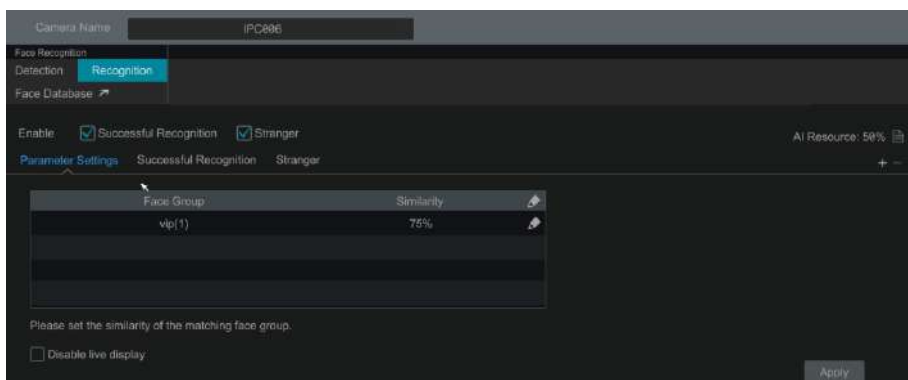

- ① Enable "Successful Recognition" or "Stranger". Click "Parameter Settings" to set the similarity of the matching face group.
Disable live display: if checked, the live view interface (target detection tab) will not display captured faces in real time.
- ② Set the alarm linkage items of successful recognition.

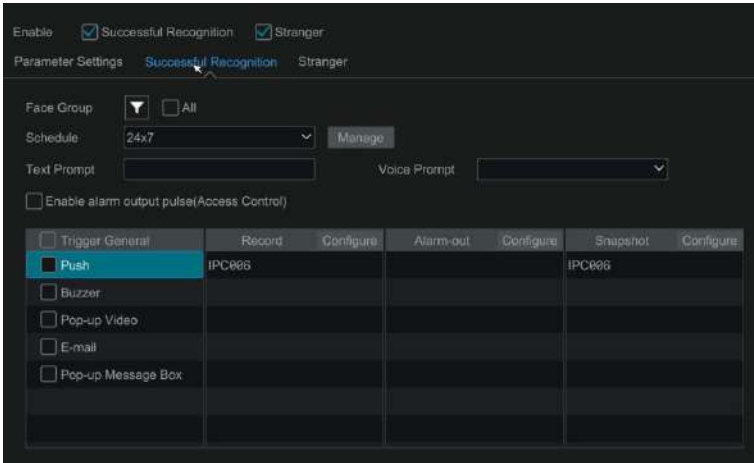

- Select one or more face groups and then choose the schedule. Click "Manage" to set the schedule.
 - Set the text prompt and voice prompt. When the captured face is matched successfully, the text will appear on the right of the live view interface and broadcast the audio.
 - Enable alarm output pulse (access control).
 - Trigger record, snapshot, alarm-out, buzzer, push, pop-up video, E-mail and pop-up message box as needed. The alarm linkage settings are similar to the face detection alarm (see [2.1.1 Face Detection Settings](#) for details).
 - Click "Apply" to save the settings.
- ③ Set the stranger alarm linkage items. When the captured face picture doesn't match the face pictures in the face database or their similarity is lower than the set value, the captured person will be regarded as a stranger.

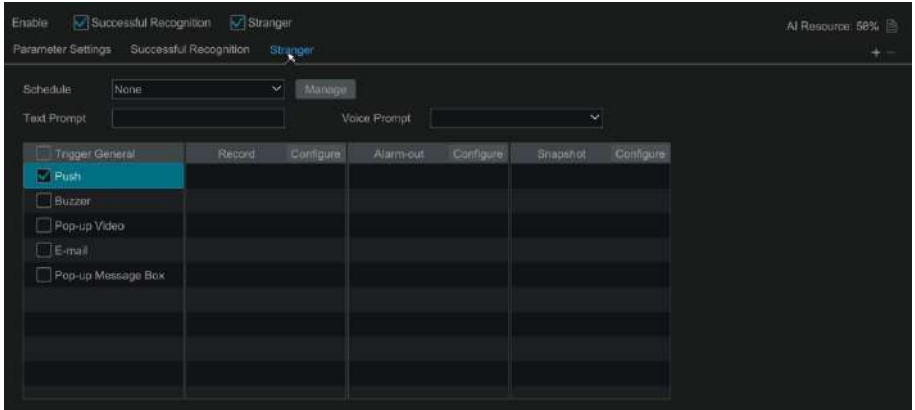

- Configure the schedule
 - Set the text prompt and voice prompt. The text will show on the captured picture and the voice will be broadcasted when detecting a stranger.
 - Trigger record, snapshot, alarm-out, buzzer, push, pop-up video, E-mail and pop-up message box as needed. The alarm linkage settings are similar to the face detection alarm (See [9.1.1 Face Detection Settings](#) for details).
 - Click "Apply" to save the settings.
- ④ Click "+" to add more successful recognition tasks. Select the added task and then click "-" to delete it.

9.2 License Plate Recognition

Please add the ANPR camera before you using this function. If your camera doesn't support this function, please skip the following instruction.

Please set license plate recognition function according to the following procedures for the first time.

Enable and set plate detection→Add plate group→Add plates to the plate group→Enable license plate recognition→Set successful recognition (or strange plate) alarm linkage

9.2.1 License Plate Detection Settings

Click Start→AI/Event→AI Event→LPR to go to the following interface. Select an ANPR camera and click the "Detection" tab as shown below.

Set the plate size by defining the maximum value and the minimum value (The default size range of a single plate occupies from 5% to 50% of the entire image).

Display range: if enabled, the set maximum detection box and the minimum detection box can be displayed on the left window.

Please select the entrance and exit according to the actual scene.

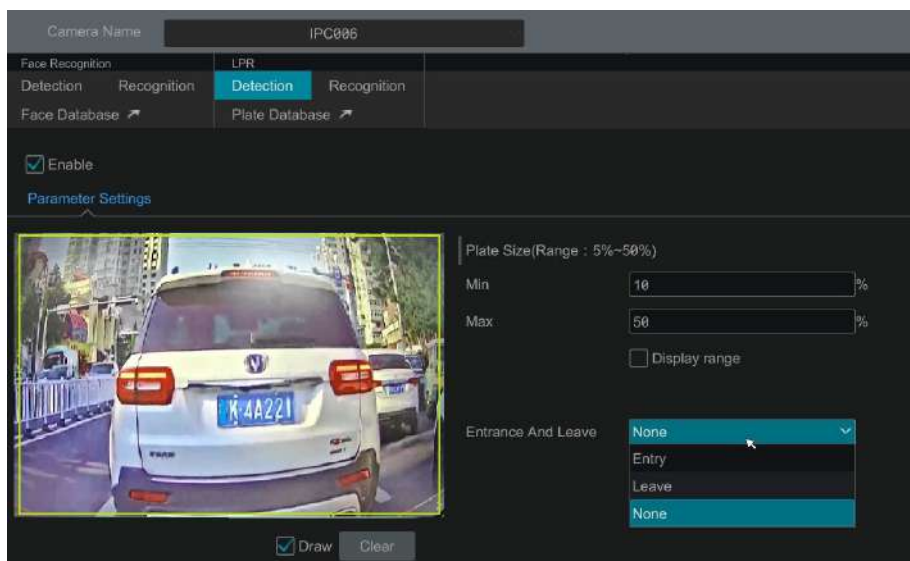

Set the alarm area. Click "Draw" and then drag the mouse to draw a detection area. Click "Clear" to delete the alarm area.

9.2.2 Plate Database Management

In the LPR interface, click the "Plate Database" tab to go to the plate database management interface as shown below.

For the first time, you can click "+" or "Add Group" to add groups.

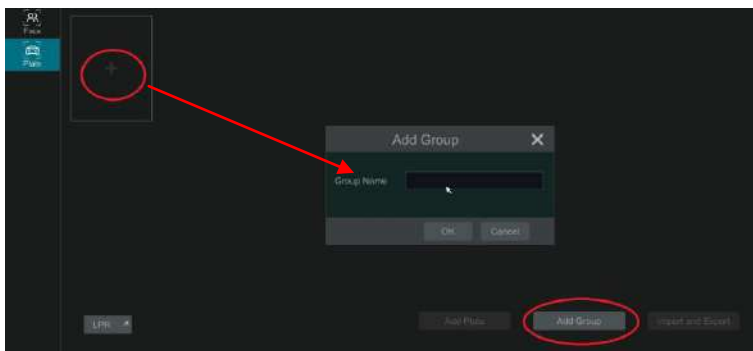

Add plates to each group:

- 1 Click  to extend the group. Click "Add Plate" to pop up the following window.

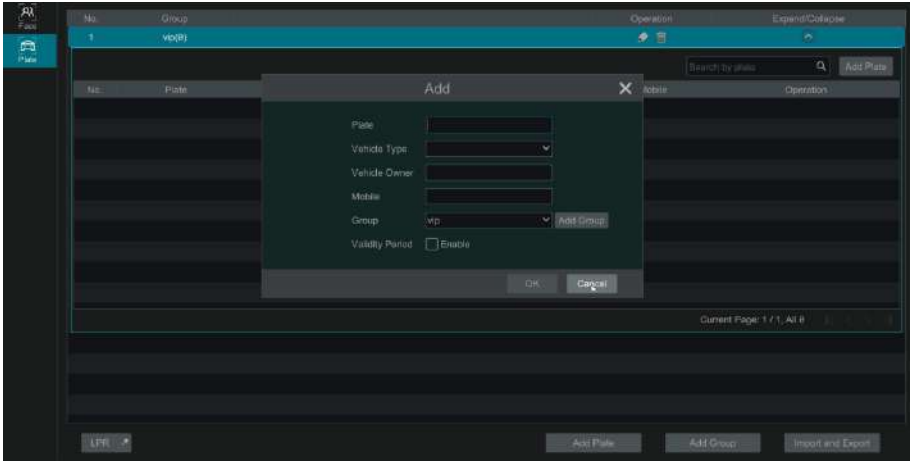

- 2 Enter the plate, vehicle owner and mobile phone number.
- 3 Select the vehicle type and group.
- 4 Enable validity period to set the start and end time
- 5 Finally click "OK" to complete.

Select the added plate and then click  to modify its information;  click to delete this plate. The plates can be imported and exported in bulk by clicking "Import and Export". You can click "Plate Information Description" to view the detailed information about how to import or export the plate list.

9.2.3 License Plate Recognition Settings

- 1 In the LPR interface, click the "Recognition" tab. Then enable "Successful Recognition" or "Strange Plate".

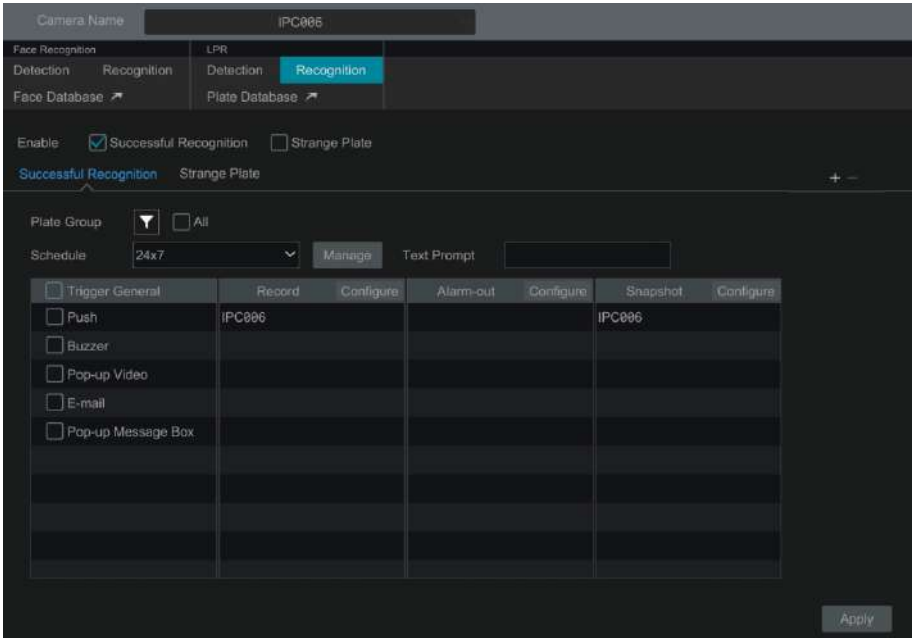

- ② Set the successful recognition alarm linkage.
 - Select one or more plate groups and then choose the schedule. Click “Manage” to set the schedule.
 - Set the text prompt. When the captured plate is matched successfully, the text will appear on the right of the live view interface.
 - Enable alarm output pulse (access control).
 - Trigger record, snapshot, alarm-out, buzzer, push, pop-up video, E-mail and pop-up message box as needed. The alarm linkage settings are similar to the face detection alarm (See [9.1.1 Face Detection Settings](#) for details).
- ③ Set the strange plate alarm linkage. When the captured plate picture doesn't match the plates in the plate database or their similarity is lower than the set value, the captured plate will be regarded as a strange plate.

9.3 Tripwire

Tripwire/Line Crossing Configuration:

Alarms will be triggered if the people or vehicles cross the pre-defined alarm line.

- ① Click Start→Settings→AI/Event→AI Event →Tripwire to go to the following interface.

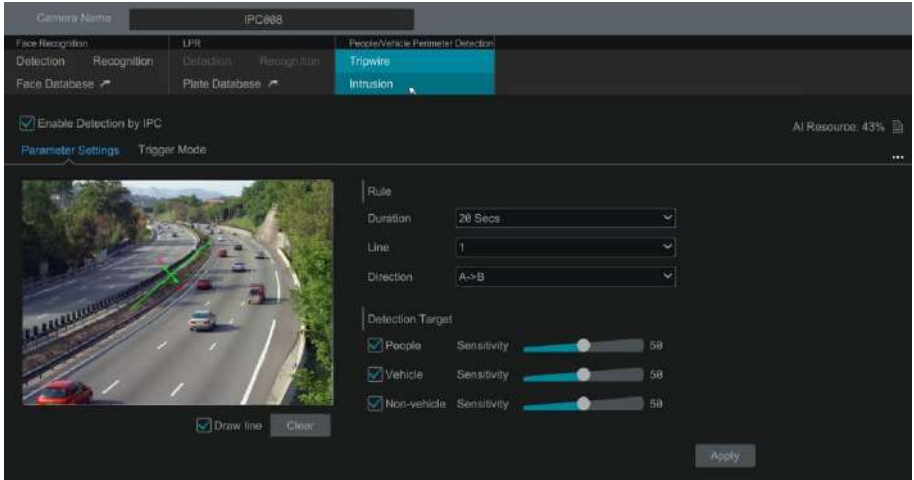

- ② Select the camera, enable tripwire detection by IPC and set the duration.
Note: Some models may support tripwire detection by NVR.
- ③ Select the direction.
Direction: A->B, A->B and A<-B optional. It is the crossing direction of the target that crosses over the alert line.
A<->B: the alarm triggers when the target crosses over the alert line from B to A or from A to B.
A->B: the alarm triggers when the target crosses over the alert line from A to B.
A<-B: the alarm triggers when the target crosses over the alert line from B to A.
- ④ Draw line. Refer to the interface as shown above. Check "Draw line" and then drag the mouse in the image to draw an alert line. Uncheck the "Draw line" if you finish the drawing. Click the "Clear" to delete the alert line.
- ⑤ Click "Detection Target" to choose the detection target and the sensitivity. The detection target includes people, vehicle and non-vehicle. Only some IPCs can detect human or vehicle separately. If the camera doesn't support this function, please skip this step.
- ⑥ Click "... " to choose "Save original picture" or "Save target picture" on the SD card of the camera. (If your camera doesn't support this function, please skip this step).
- ⑦ Click "Trigger Mode" to configure tripwire alarm linkage items.
 - Enable or disable "Record", "Snapshot", "Push", "Alarm-out", "Preset", "Buzzer", "Pop-up Video" and "E-mail". The alarm linkage settings are the same as the face detection alarm (see [9.1.1 Face Detection Settings](#) for details).
 - Enable "IPC_Audio" or "IPC_Light" as needed (only some IPCs support these two functions). To set the IPC voice and its times and volume, please refer to [11.5.6 Audio](#) for details. To set the light flashing time and frequency of the IPC, please refer to [11.5.7 Light](#) for details.
- ⑧ Click "Apply" to save the settings.

9.4 Intrusion Detection

Intrusion Detection Configuration:

Alarms will be triggered if the people or vehicles intrude into the pre-defined area.

① Click Start→Settings→AI/Event→AI Event→Intrusion to go to the following interface.

② Select the camera, enable the intrusion detection by IPC and set the duration.

Note: Some models may support tripwire detection by NVR.

③ Select regional activities. “Appear” or “Cross” can be selected (if your camera doesn’t support region entrance/exiting detection, “Cross” will not be enabled). If “Cross” is selected, you can choose the crossing direction.

④ Select the alarm area. Up to 4 alarm areas can be set up.

⑤ Draw the alarm area of the intrusion detection. Refer to the interface as shown below. Check “Draw Area” and then click around the area where you want to set as the alarm area in the image (the alarm area should be a closed area). Uncheck the “Draw Area” if you finish the drawing. Click the “Clear” to delete the alarm area.

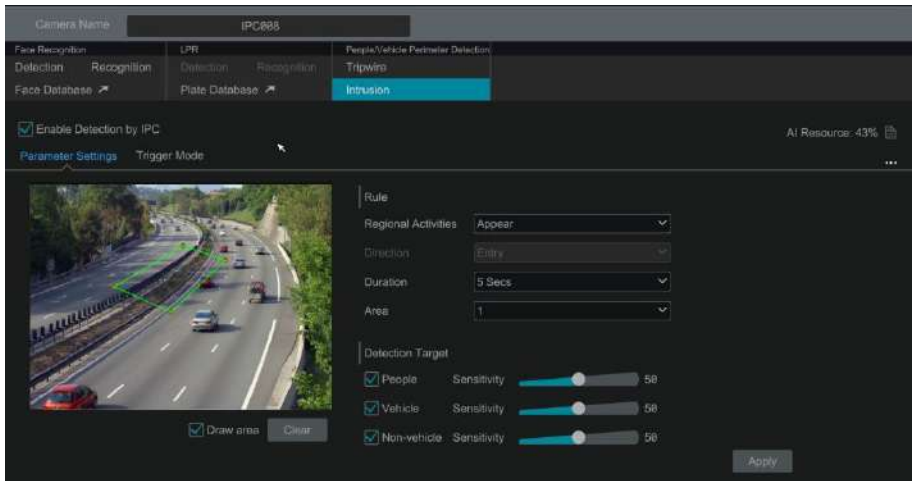

⑥ Click “Detection Target” to choose the detection target and the sensitivity. The detection target includes people, vehicle and non-vehicle.

⑦ Click “Trigger Mode” to configure intrusion detection alarm linkage items.

- Enable or disable “Record”, “Snapshot”, “Push”, “Alarm-out”, “Preset”, “Buzzer”, “Pop-up Video” and “E-mail”. The alarm linkage settings are the same as the face detection alarm (see [9.1.1 Face Detection Settings](#) for details).

- Enable "IPC_Audio" or "IPC_Light" as needed. (only some IPCs support these two functions). To set the IPC voice and its times and volume, please refer to [11.5.6 Audio](#) for details. To set the light flashing time and frequency of the IPC, please refer to [11.5.7 Light](#) for details.
- ⑧ Click "Copy To" to copy all settings to other cameras.
- ⑨ Click "Apply" to save the settings.

9.5 Abandoned/Missing Object Detection

- ① Click Start→Settings→AI/Event→AI Event→Object Abandoned/Missing to go to the following interface.
- ② Select the camera, enable the object detection and set the duration and detect type. There are two detection types: Abandoned object and missing object.

Abandoned object: Alarms will be triggered if there are articles left in the pre-defined detection area.

Missing object: Alarms will be triggered if there are articles missing in the detection area drew by the users.

- ③ Select the alarm area and area name. A maximum of 4 alarm areas can be set.
- ④ Draw the alarm area of the object detection. Refer to the interface as shown above. Check "Draw Area" and then click around the area where you want to set as the alarm area in the image (the alarm area should be a closed area). Uncheck the "Draw Area" if you finish the drawing. Click the "Clear" to delete the alarm area.

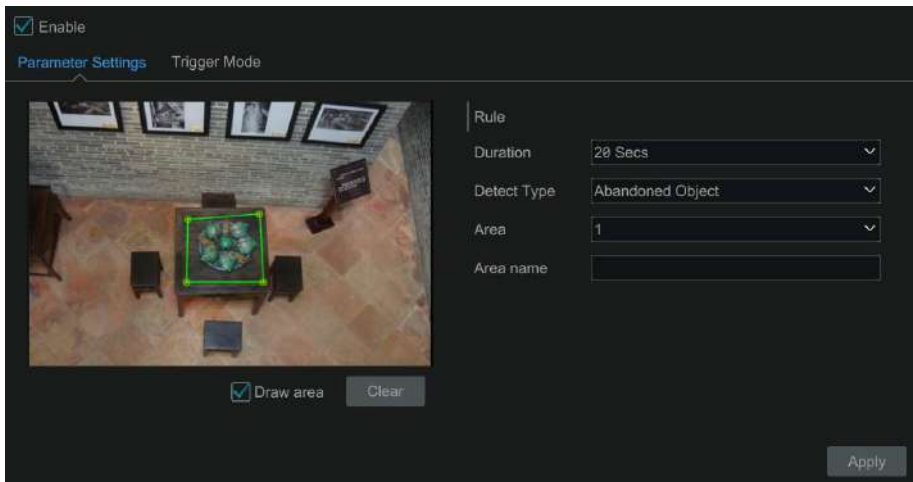

- ⑤ Click "Trigger Mode" to configure abandoned/missing object detection alarm linkage items. Enable or disable "Record", "Snapshot", "Push", "Alarm-out", "Preset", "Buzzer", "Pop-up Video" and "E-mail". The alarm linkage settings are the same as the face detection alarm (see [9.1.1 Face Detection Settings](#) for details).
- ⑥ Click "Apply" to save the settings.

9.6 Crowd Density Detection

Only some IPCs may support this function.

Crowd Density Configuration:

Alarms will be triggered if the crowd density exceeds the set threshold value in the pre-defined area.

- ① Click Start→Settings→AI/Event→AI Event→Crowd Density to go to the following interface.

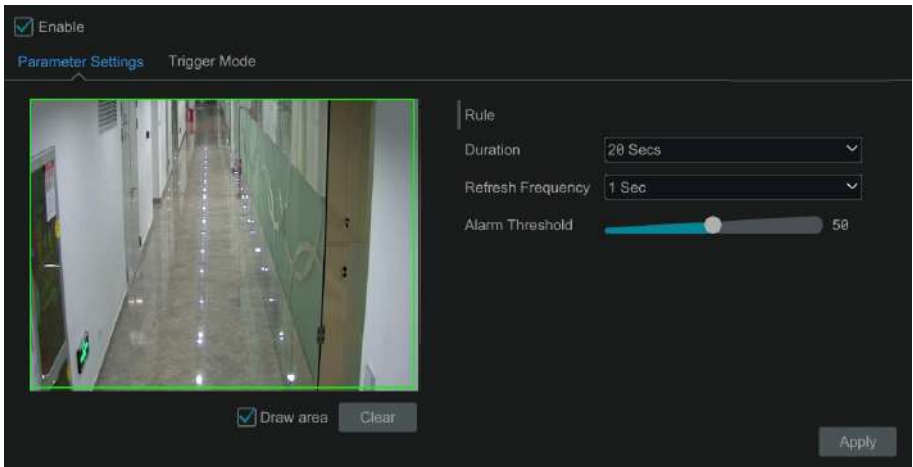

- ② Select the camera, enable the crowd density detection and set the duration, refresh frequency and alarm threshold.
Refresh Frequency: It refers to the refresh time of the detection result report.
Alarm Threshold: Alarms will be triggered once the percentage of the crowd density in a specified area exceeds the pre-defined threshold value.
- ③ Select the alarm area. Draw the alarm area of the crowd density detection. Refer to the interface as shown below. Check "Draw Area" and then drag the mouse to draw a rectangle area. Uncheck the "Draw Area" if you finish the drawing. Click the "Clear" to delete the alarm area.

- ④ Click  to configure crowd density detection alarm linkage items. Enable or disable "Record", "Snapshot", "Push", "Alarm-out", "Preset", "Buzzer", "Pop-up Video" and "E-mail". The alarm linkage settings are the same as the face detection alarm (see [9.1.1 Face Detection Settings](#) for details).
- ⑤ Click "Apply" to save the settings.

9.7 Line Crossing Counting

Only some IPCs may support this function.

People counting in the pre-defined area:

This function is to calculate the number of people entering or exiting in the detected area on the video by detecting, tracking and counting the head shapes of people.

Note: Only some specific IPCs may support this function.

- ① Click Start→Settings→AI/Event→AI Event→Line Crossing Counting to go to the following interface.
- ② Select the camera, enable the line crossing people counting detection and set the duration, sensitivity, statistic cycle, enter threshold, departure threshold and retention threshold.

Statistic cycle: Always, daily, weekly and monthly are optional.

Manual Reset: The current number of people counting will be cleared and the statistic cycle will restart by clicking "Manual Reset" button.

- ③ Set the alarm area and entrance direction. Click "Draw Area" and drag the mouse to draw a rectangle area. Drag the rectangle to change its position. Uncheck the "Draw Area" if you finish the drawing. Click "Clear" to clear the area. Click and drag the arrow or the other end of the arrow line to change the people entrance direction.

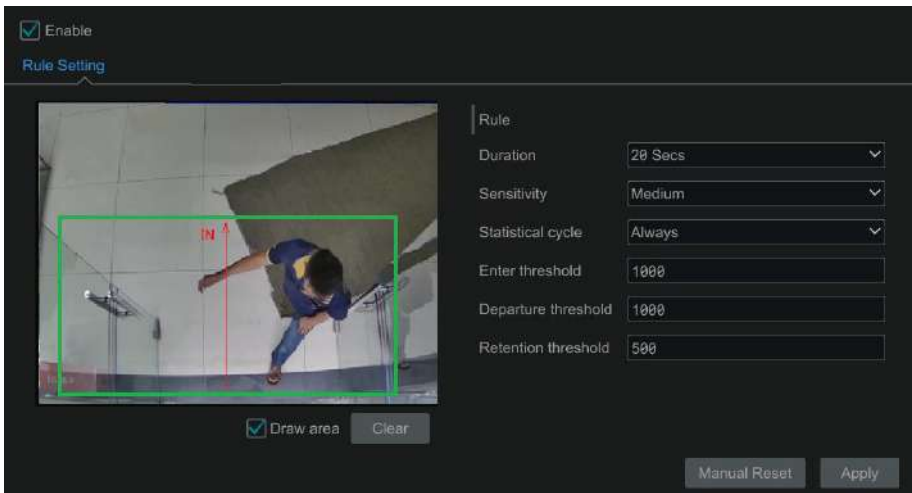

Enable

Rule Setting

Draw area Clear

Manual Reset Apply

Rule	
Duration	20 Secs
Sensitivity	Medium
Statistical cycle	Always
Enter threshold	1000
Departure threshold	1000
Retention threshold	500

- Click "Apply" to save the settings.

Line Crossing People/Vehicle/Non-Vehicle Counting

Only some IPCs support this function. If your camera doesn't support this function, please skip the following instructions.

- Click Start→Settings→AI/Event→AI Event→Line Crossing Counting to go to the following interface.

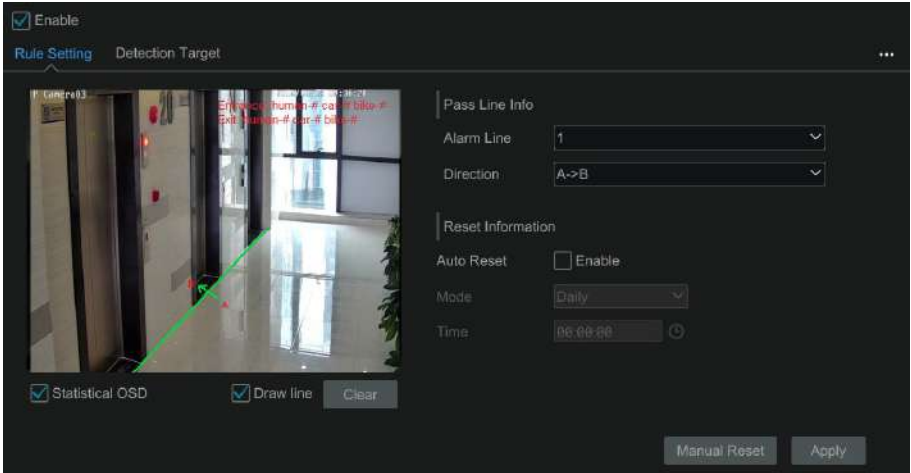

- Enable line crossing counting.
 - Check "Draw line" and then drag the mouse on the small window to draw the crossing line. Uncheck "Draw line" to finish the drawing. Click "Clear" to delete the alert line.
- Direction:** A->B and A<-B are optional. It is the crossing direction of the target that crosses over the alert line.
- Check "Statistical OSD", the statistical information will be displayed on the live view interface.
 - Set the reset information. You can set reset information manually or enable "Auto Reset" as needed.
 - Click the "Detection Target" tab to set the detection target, including people, vehicle and non-vehicle.
 - Click "Apply" to save the settings.

9.8 Exception Detection

Exception Detection Configuration:

- Click Start→Settings→AI/Event→AI Event→Exception Detection to go to the following interface.

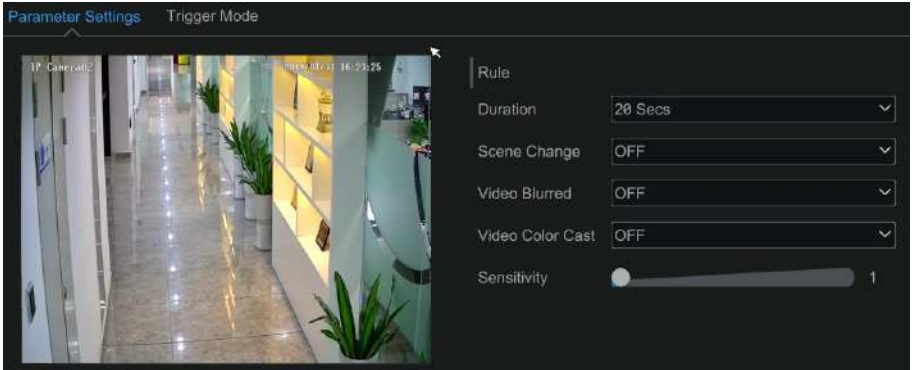

② Select the camera and detection duration and then enable the relevant detection as needed.

Scene Change: Alarms will be triggered if the scene of the monitor video has changed.

Video Blurred: Alarms will be triggered if the video becomes blurry.

Video Color Cast: Alarms will be triggered if the video becomes obscured.

③ Set the sensitivity of the exception detection.

④ Click "Trigger Mode" to configure exception alarm linkage items. Enable or disable "Record", "Snapshot", "Push", "Alarm-out", "Preset", "Buzzer", "Pop-up Video" and "E-mail". The alarm linkage settings are the same as the face detection alarm (see [9.1.1 Face Detection Settings](#) for details).

⑤ Click "Apply" to save the settings.

10 Intelligent Analytics



10.1 Target Detection View

Only some models support target detection view. If your device doesn't support it, please skip the following instructions.

10.1.1 Human Body/Vehicle Detection View

Only when the camera supports human body/vehicle detection, can you view the real-time captured people or vehicle pictures. The setting steps are as follow:

① Enable the Tripwire/Intrusion function of IPCs/NVR, draw the line or area and choose the detection target (see [9.3 Tripwire](#) and [9.4 Intrusion Detection](#) for details).

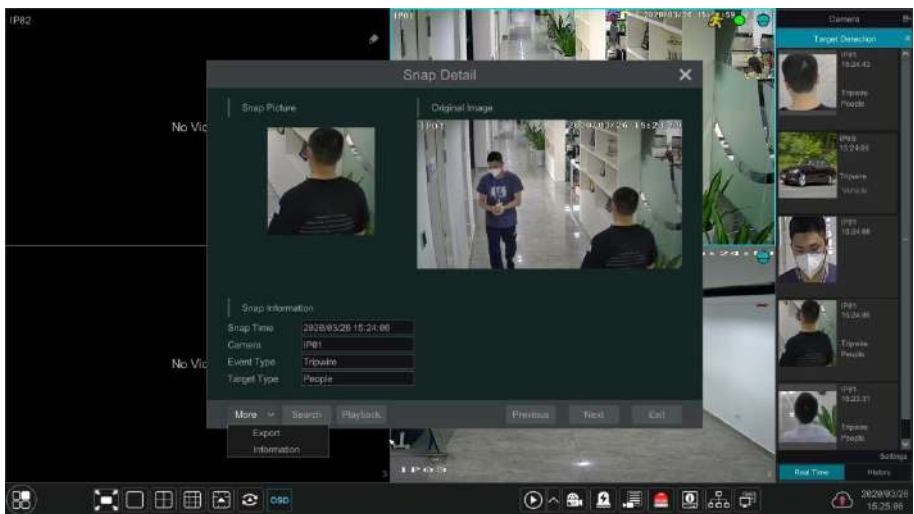

② Go to live view interface and then click  to go to the target detection interface of this channel. In this interface, you can switch the channel on the top right. You can also click  on the top right corner of the live view interface and then choose the target detection tab to go to the target detection interface of multi-channel as shown below. Click the captured picture on the right of the live interface to see the snapshot detailed information, such as snapshot time, camera, event type and target type.







Click “More” to bring up a dropdown list. You can export the captured pictures by clicking “Export” or view the target ID by clicking “Information”. Click “Search” to go to smart human body/vehicle search interface. The system will automatically search captured people/vehicles. Click “Playback” to go to the playback interface.

10.1.2 Face Detection/Match View

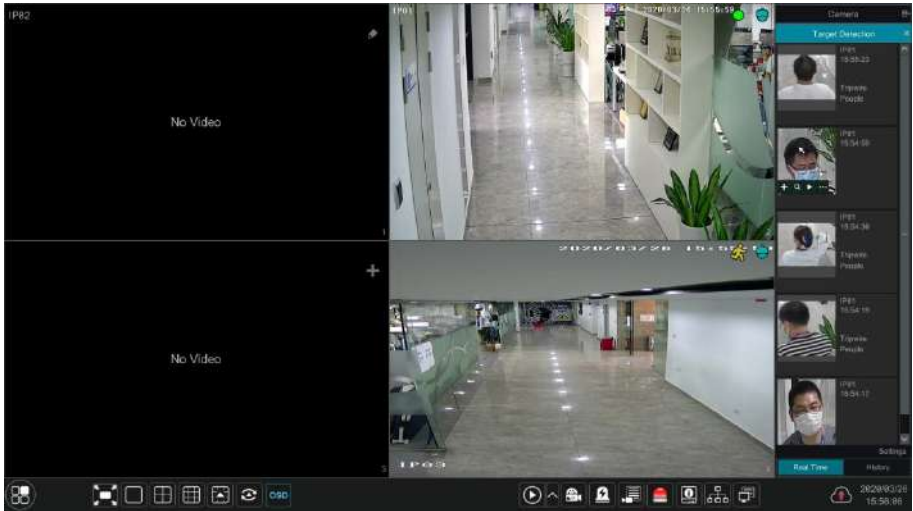
Only the face recognition NVR supports the following functions. If your NVR doesn't support them, please skip the following instructions. The setting steps are as follow:

- ① Enable face detection function (see 9.1.1 Face Detection Settings for details).
- ② Enable face recognition function and set the alarm linkage items (see 9.1.3 Face Recognition Settings for details).
- ③ Go to live view interface and click on a face detection channel. This will bring a toolbar under the channel. Then click  to go to the target detection interface of this channel. In this interface, you can switch the channel on the top right. You can also click  on the top right corner of the live view interface and then choose the target detection tab to go to the target detection interface of multi-channel as shown below.



For unknown faces, you can select this face and click  under the captured face to register this face (see the following picture); click  to quickly go to the smart face search interface where you can search the matching face information; click  to quickly go to the smart face playback interface; click  to view snapshot details.

Register

Snap Picture

Name

Sex Male

Birthday 2020/03/26

Native Place

ID Type ID Card

ID Number

Mobile No.

Remark

Group 1 Add Group

OK Cancel

Before registering target face pictures, please add groups for them in advance (see [9.1.2 Face Database Management](#) for details).

After the face pictures are registered, the system will compare them automatically once the corresponding faces are captured next time. Refer to the following picture.

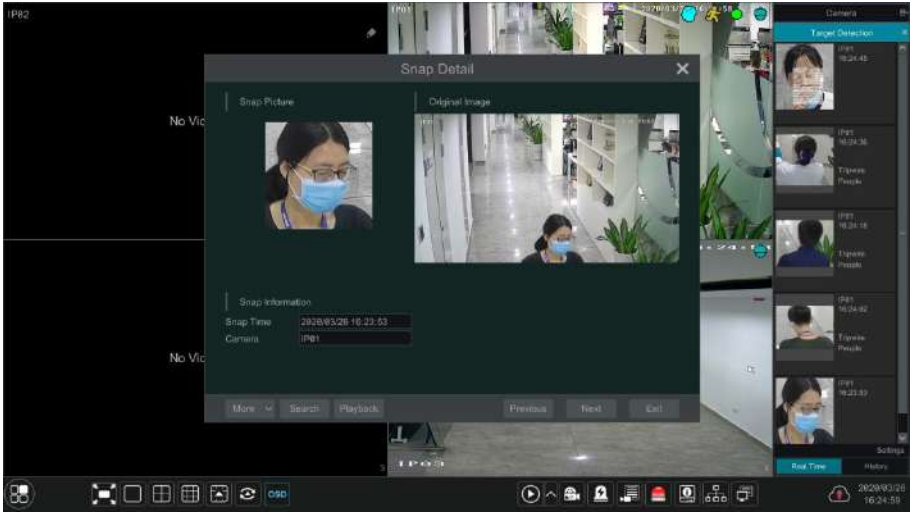

Double click the face picture to see the snapshot details, such as snapshot picture, original image, snapshot time and camera. Click “more” and then a dropdown list will display. Click “Register” to register the current snapshot. Click “Search” to go to face search interface. Click “Playback” to go to the playback interface. Click “Export” to export this snapshot details. Click “Information” to view face ID.

In the face match interface, click “Settings” to pop up the following window.

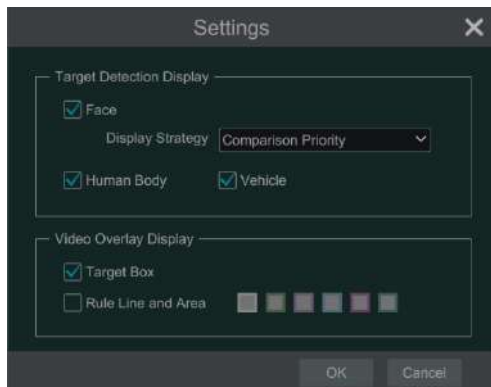

Target Detection Display: Face, human body and vehicle can be enabled. If disabled, the captured target picture will not be displayed under the target detection tab in the live view interface.

Display Strategy: Two options-Comparison priority and only comparison

Video Overlay Display: If "Target box" is clicked, you will see the target traced by a little red box.

If "Rule Line and Area" is checked, you will see the rule line of tripwire detection and detection area of intrusion detection displayed on the screen. You can select the color of the rule line and area as needed.

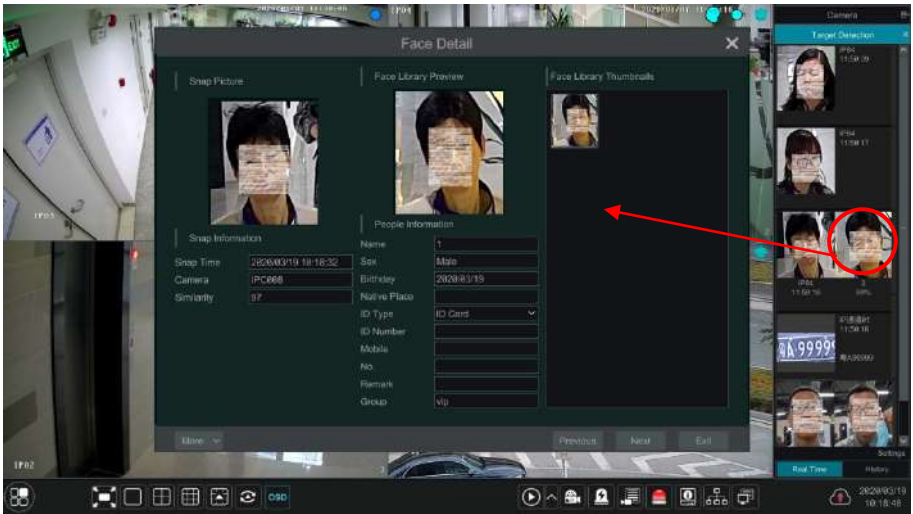

When the captured face pictures are successfully recognized, click the picture on the right to pop up a face detail window as shown below. In this window, you can see the captured face picture, the matched picture of face library and the relevant information. You also can view the original image, search image by snapshot, play back by snapshot and export the face details by clicking "More" button.

Additionally, you can view the historical captured face pictures and face match information in the face match interface by clicking "History" tab. Besides registering face pictures in the live view interface, you can also add target face pictures in the face database interface.

10.1.3 License Plate Detection/Recognition View

Only when the ANPR camera is added and enabled, can license plates be captured and matched.

The setting steps are as follows

① Enable the plate detection function (See 9.2.1 License Plate Detection Settings for details). Then you can see the captured plates displayed in the live view interface as shown below.

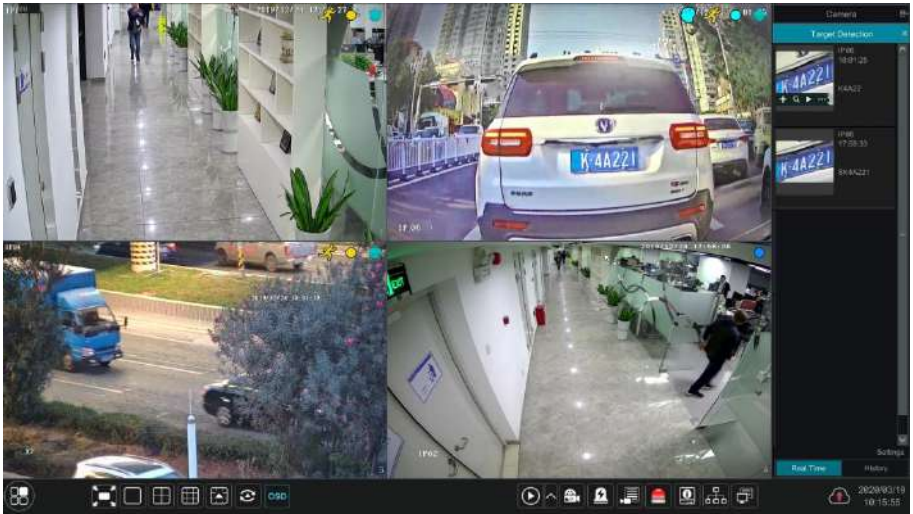

Put the cursor on the captured plate picture and then click  to register this plate as shown below.

Add
✕

Plate

Vehicle Type



Vehicle Owner

Mobile

Group Add Group

Validity Period Enable

OK
Cancel

Click  to view the captured detail information. Click  to quickly enter the vehicle search interface. You can search the matched plate information in this interface. Click  to go to the smart playback interface.

② Enable license plate recognition function and set the alarm linkage items (see [9.2.3 License Plate Recognition Settings](#) for details).

③ Go to live view interface and click  on the top right corner of the live view interface and then choose the target detection tab to go to the target detection interface of multi-channel as shown below. When the plate is captured, it will be displayed on the right panel. If this plate is successfully matched, it will show “successful” beside the plate picture. The strange plate will show “Strange plate” beside the plate picture.

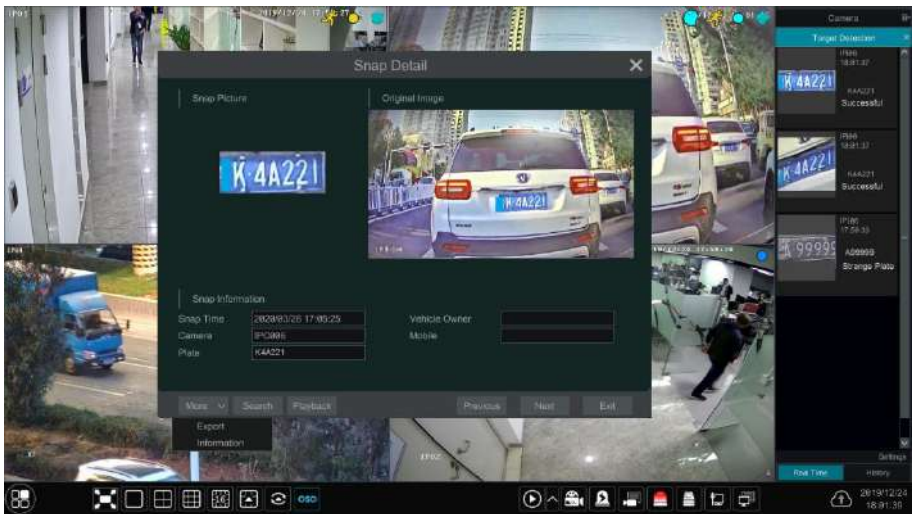

Click the captured plate picture and then it will pop up the detailed information window. You can view the snapshot picture, original picture, snapshot time, camera, etc. Click “More” to view the ID information of the target and export the captured picture. Click “Search” to go to the vehicle search interface. Click “Playback” to go to the playback interface.

10.2 Smart Search

10.2.1 Face Search

Only some models support this function. If your device doesn't support it, please skip the following instructions.

➤ Face Search by Event

① Click Start→Intelligent Analytics→Search→Face to go to the following interface.



② Click  to choose face detection cameras.



③ Select all events, successful recognition or stranger.

④ Click "Search" to search face pictures. You can view face pictures by time or by camera.

⑤ Click the searched face picture to play in the small playback window; select a face picture and click "Backup" to export it.

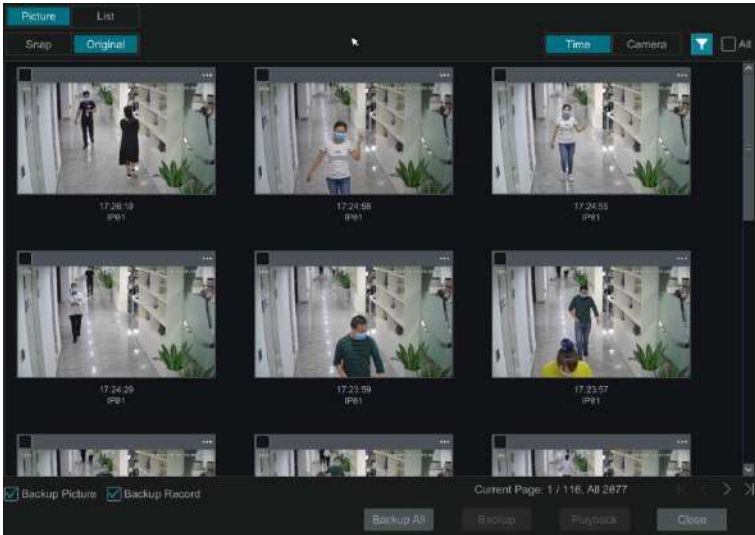
Click "Original" to see the original image as shown below.



Click "List" to view the snapshot information list. Click  to view the detail information; click  to back up the image.

No.	Snap Time	Similarity	Details	Backup
1	2020/03/26 17:26:16	-		<input type="checkbox"/>
2	2020/03/26 17:24:58	-		<input type="checkbox"/>
3	2020/03/26 17:24:56	-		<input type="checkbox"/>
4	2020/03/26 17:24:29	-		<input type="checkbox"/>
5	2020/03/26 17:23:59	-		<input type="checkbox"/>
6	2020/03/26 17:23:57	-		<input type="checkbox"/>
7	2020/03/26 17:23:56	-		<input type="checkbox"/>
8	2020/03/26 17:23:54	-		<input type="checkbox"/>
9	2020/03/26 17:23:29	-		<input type="checkbox"/>
10	2020/03/26 17:23:29	-		<input type="checkbox"/>
11	2020/03/26 17:21:26	-		<input type="checkbox"/>
12	2020/03/26 17:21:17	-		<input type="checkbox"/>
13	2020/03/26 17:21:17	-		<input type="checkbox"/>
14	2020/03/26 17:21:14	-		<input type="checkbox"/>
15	2020/03/26 17:21:12	-		<input type="checkbox"/>
16	2020/03/26 17:20:57	-		<input type="checkbox"/>

➤ Face Search by Face

In the face picture search interface, click "By Face" to go to the following interface.

① Click **+** to add the target face which can be searched and added from recent, face database, snapshot gallery and external faces. A single face picture or multiple face pictures can be added and searched. (Take a single face picture for example)

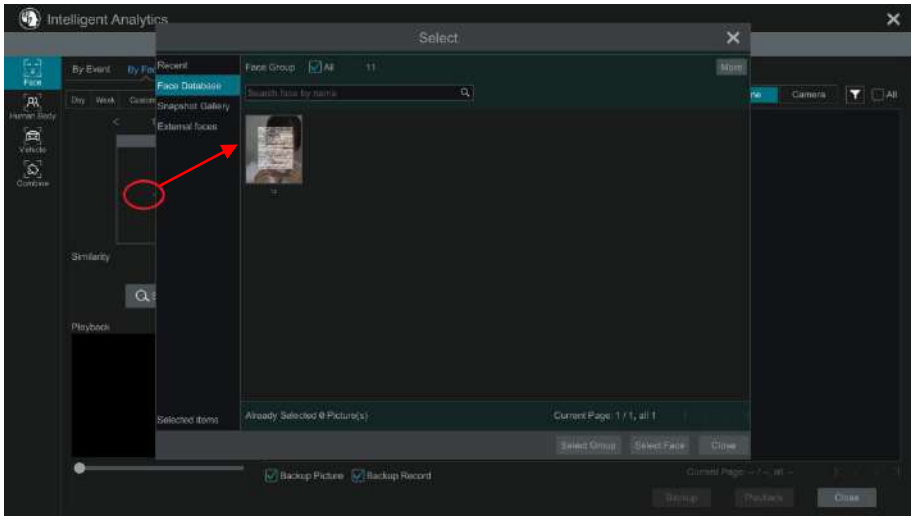

To add target face from recent

- Choose the face.
- Click "Select Face".

To add target face from face database:

- Click "More" to choose groups.
- Select a target face and click "Select Face".

To add target face from snapshot gallery:

- Select time and click "More" to choose cameras.
- Click "Search".
- Check a face and click "Select Face".

To add target face from external face:

- Save the target face to the mobile storage device and then insert this device into the USB interface of NVR.
- Select "External Face" to import the face in this interface.

- ② Set similarity and then click "Search".
- ③ Click the searched image to play records in the small window.
- ④ Select the searched image and click "Backup Picture" or "Backup Record". Then click "Backup" to build backups for pictures or records.

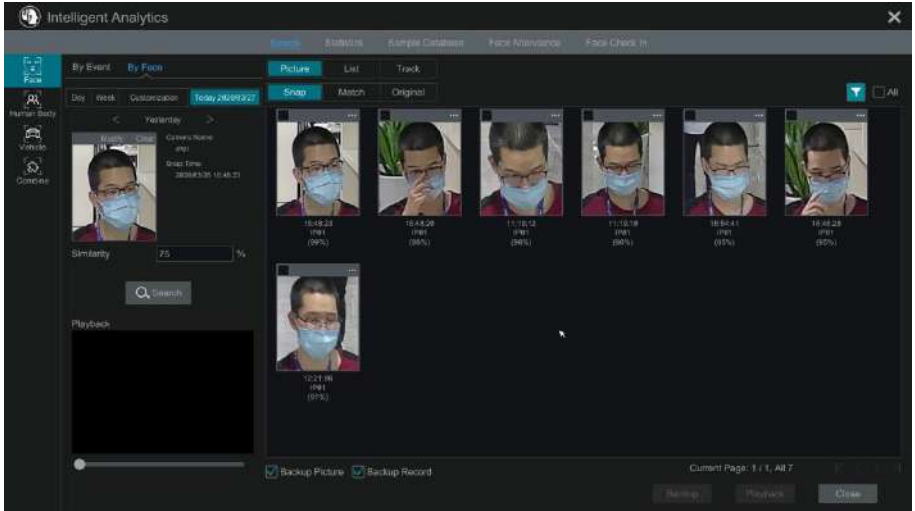

● **View Image by List**

Click "List" tab to view images by time as shown below.



Click the searched image to play. Click  to view the detail information of the compared target face.

- **View Match Images**

Click "Match" tab to view match images as shown below.

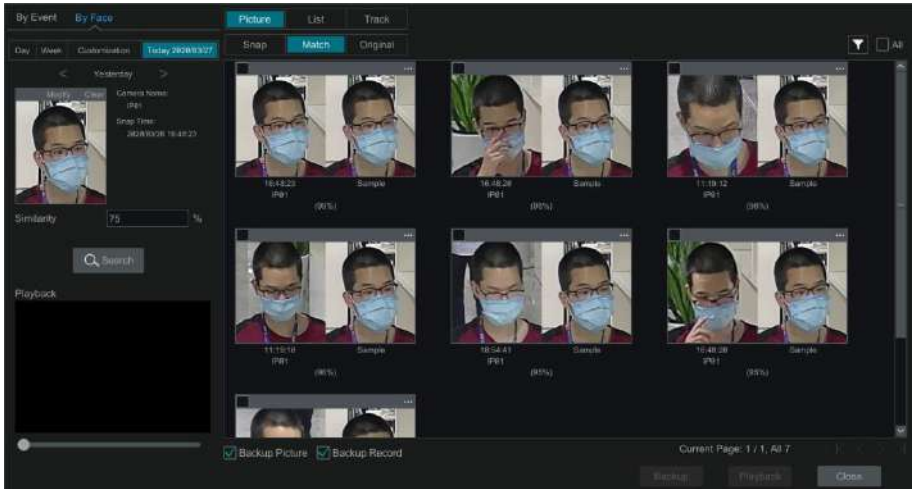





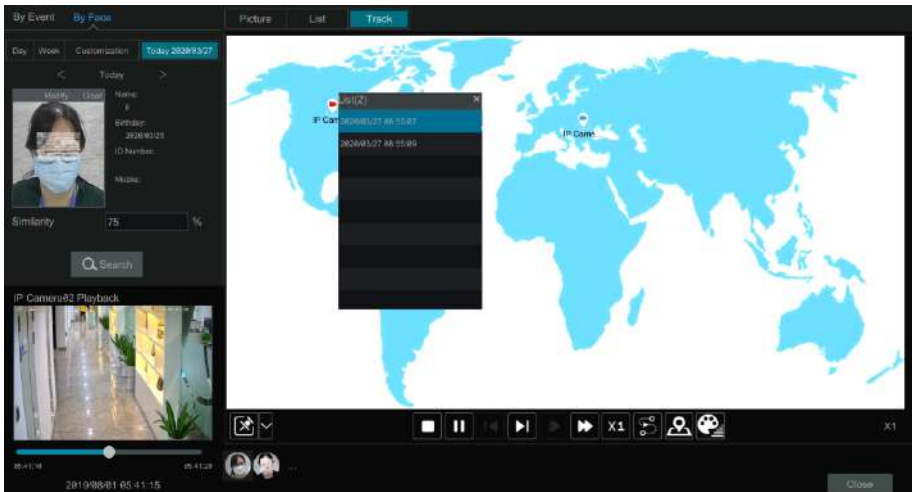







10.2.2 Track Playback

Select "Track" to go to the following interface.





Note: Only when two or more cameras detect this person, can his/her track can be viewed here. Descriptions of buttons on the track interface

	Fixed Window		Frame
	Followed Window		Fast Forward (x2;x4)
	Exchange Window		Normal Speed
	Stop		Start/Stop Track
	Play		Edit Map
	Previous		Edit Color
	Next		

Click on the camera name and then an event list appears. Click one item to play the record.

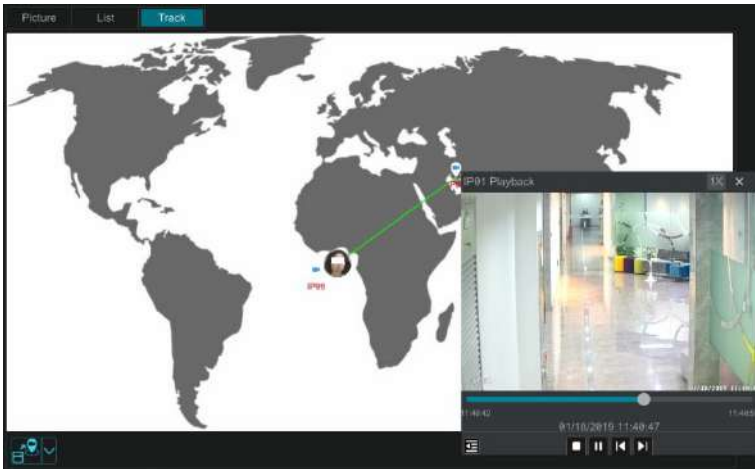
Click  button beside the fixed window icon to show "Followed Window" and "Exchange Window" icons. The small playback window will float on the map window by clicking "Followed Window" as shown below.



Click  to switch play speed. 1x and 2x can be switched. Click  to view event list. Click one item to play this event.

Click "Exchange Window" to switch the position of the map window and the playback window.

Click  button to go to the following interface.

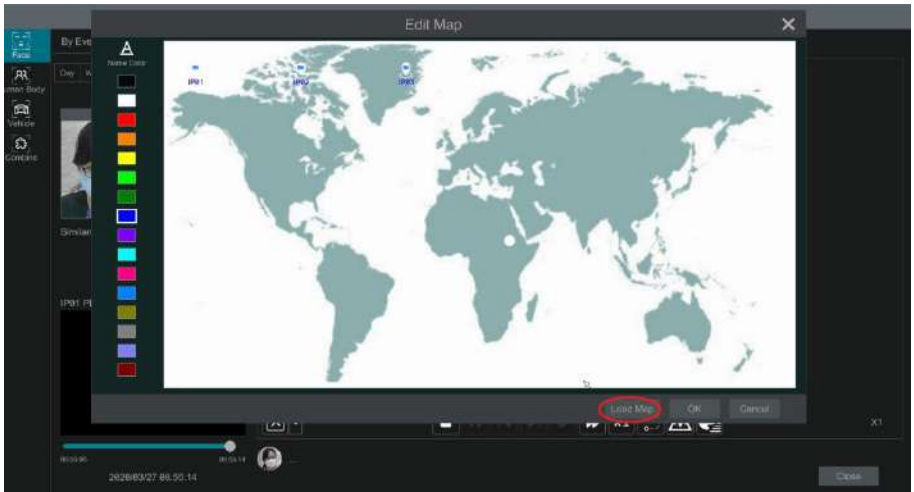

Click "Load Map" to add a map. Then drag the camera names on the map to change their locations. Choose a color on the left color list to set your favorite color for camera names. Load Map: ① Save the map to the USB storage device and then insert the USB storage device into the NVR. ② Click "Load Map" button to upload the map.

Click  button to modify the colors of camera name and track line and set the line width.

10.2.3 Face Search by Snapshot

In the live or playback interface, click on a face detection camera and then select  on the toolbar. This will bring the following window.

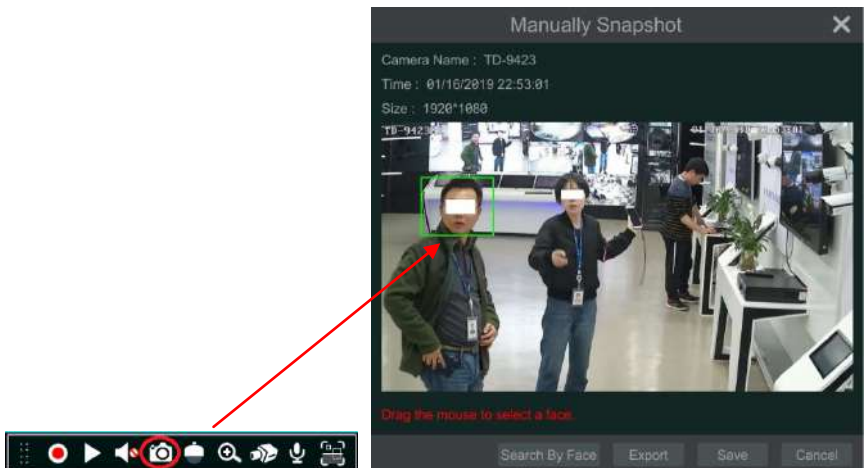

Drag the mouse to select a face and then click "Search by Face" to go to the face search by face interface. You can see its snapshot pictures, match pictures, original pictures and so on by clicking the corresponding tab.



10.2.4 Human Body Search

Click Start→Intelligent Analytics→Smart Search→Human Body to go to the human body search interface.

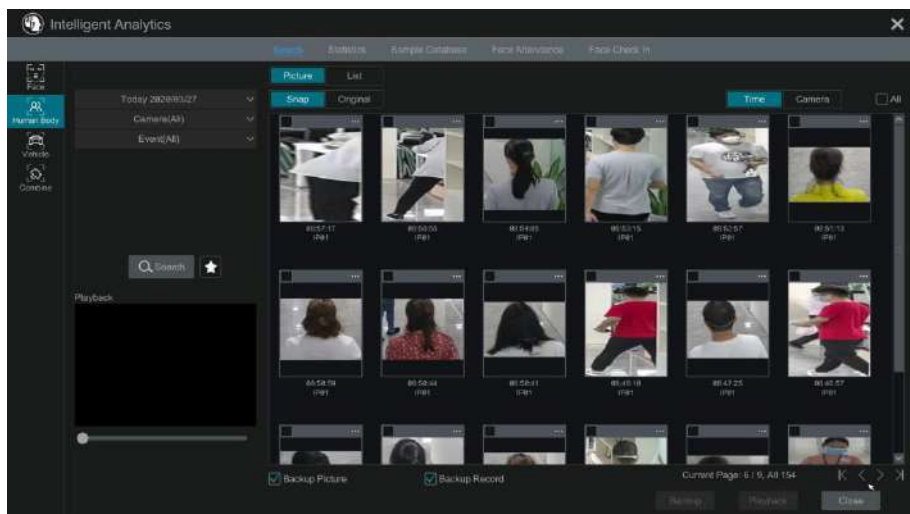
Select the search time, camera and event and then click "Search" to view the searched pictures.



Click the searched picture to play the record in the small window. Select pictures and check "Backup Picture" and/or "Backup Record" and then click "Backup" to back up the pictures and /or records. Click "Original" to view the captured original pictures. Click "List" to view the file list of the captured pictures.

Click  and select "Add to favorite" to add a favorite group and save the current searched pictures to the favorite group. Then you can quickly view these figure pictures by clicking  and choosing the group name.

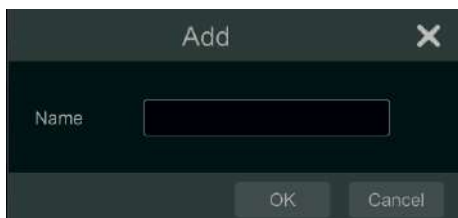
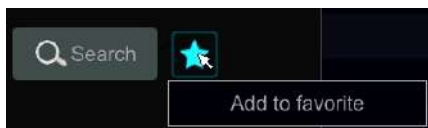

10.2.5 Vehicle Search

① Click Start→Intelligent Analytics→Smart Search→Vehicle to go to the vehicle search interface.

② Select the time, camera, event and vehicle type. Then click "Search" to search vehicles. Event: Intrusion, Tripwire, Line Crossing Counting, Plate Detection, Plate Match-Successful Recognition and Plate Match-Strange Plate can be selected.

Attribution: Vehicle or non-vehicle can be selected.

You can view face pictures by time or by camera.

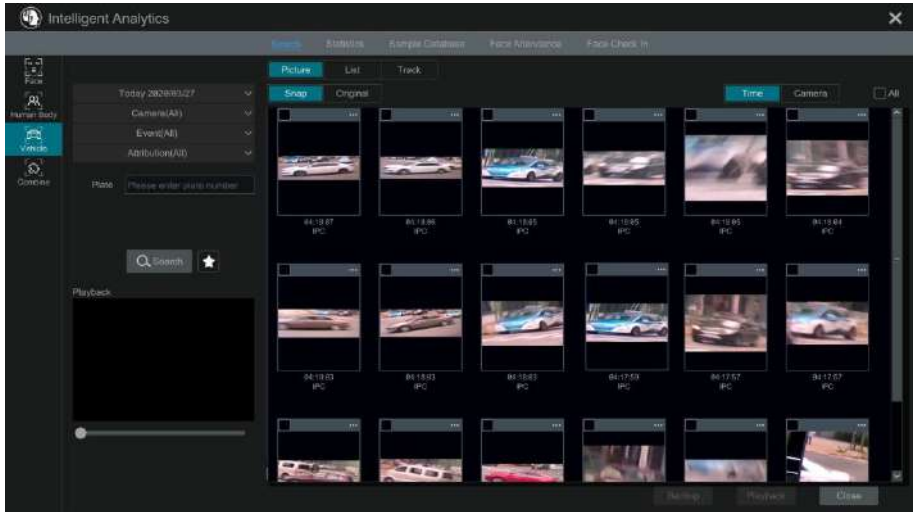

Click a searched vehicle picture to play it in the small window. Select vehicle pictures and check "Backup Picture" and/or "Backup Record" and then click "Backup" to back up the pictures and /or records.

③ Click "Original" to see the original pictures; click "List" to view the snapshot information list.

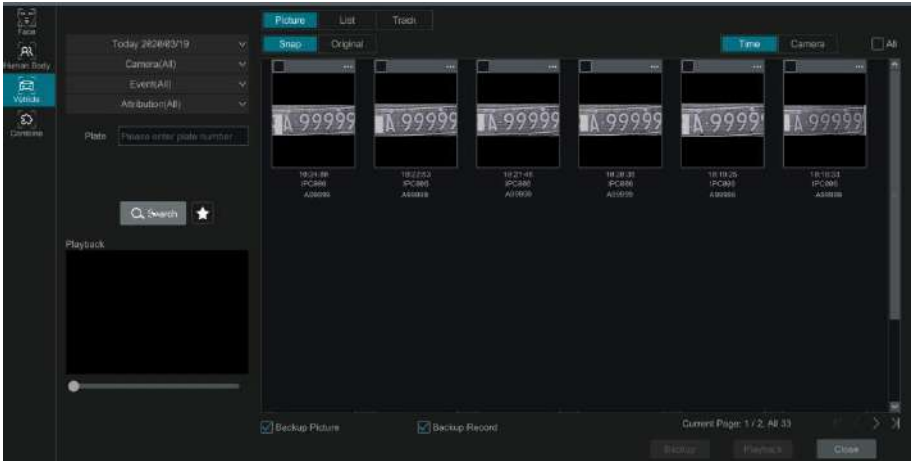

Click  to view the detail information; click  to back up the image.

Select "Plate Detection" or "Plate Match" to view plate image. You can also enter the plate number to search the plate pictures. Then you can view the track of this vehicle.



Click "Track" to view the track of the vehicle.

Note: Only one plate can be traced at a time and there must be two or more ANPR cameras detect this vehicle, thus, you can view the track of this vehicle. The track setting steps are similar to the face track settings. Please refer to face track settings for details.

Click  to add a favorite group and save the current searched pictures to the favorite group. Then you can quickly view these vehicle pictures by clicking  and choosing the group name.



10.2.6 Combination Search

If you want to view the human body, vehicle or face pictures simultaneously, you can choose combination search.

① Click "Combine".

② Select the search time, camera, event and vehicle as needed.

Click a searched picture to play it in the small window. Select pictures and check "Backup Picture" and/or "Backup Record" and then click "Backup" to back up the pictures and /or records.

Click  to add a favorite group and save the current searched pictures to the favorite group. Then you can quickly view these pictures by clicking  and choosing the group name.

10.3 View Statistical Information

Click Start→Intelligent Analytics→Statistics to go to the following interface. In this interface, you can view the people and vehicle statistical information or you can customize the statistical information.

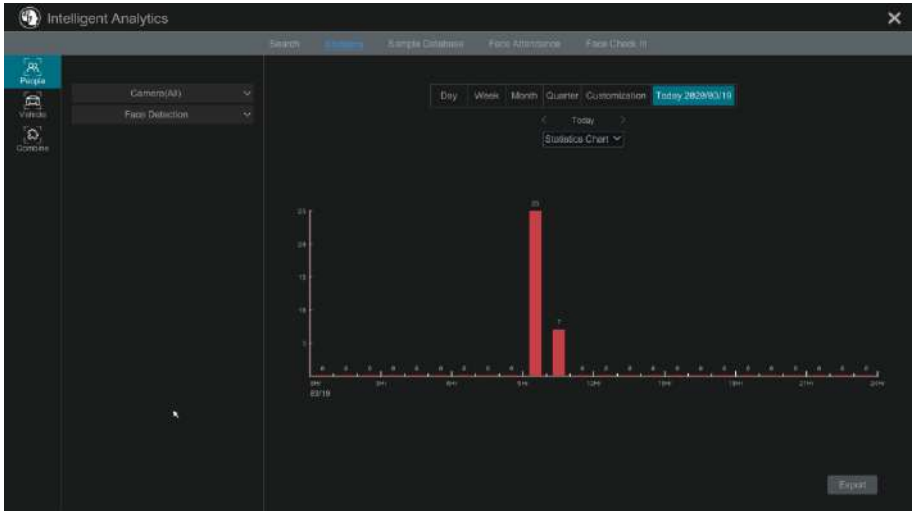

View People Information:

Note: The person information includes face information and figure information.

- ① Select the time.
- ② Select cameras.
- ③ Select events as needed, such as face detection, face recognition, intrusion, tripwire, etc. Note: Face recognition events (successful recognition & stranger) are available for some models. If Face Recognition-Successful Recognition event is selected, you can choose "Detail Chart" to view.

View Vehicle Information:

- Click "Vehicle"
- Select the time and cameras.
- Select events as needed.
- Select the vehicle attribution.

To customize statistical information:

Click "Combine" and then select events, people and vehicle as needed.

10.4 Face Attendance

This function is only available for some models. If your device doesn't support it, please skip the following instructions.

Click Start→Intelligent Analytics→Face Attendance to go to the following interface.

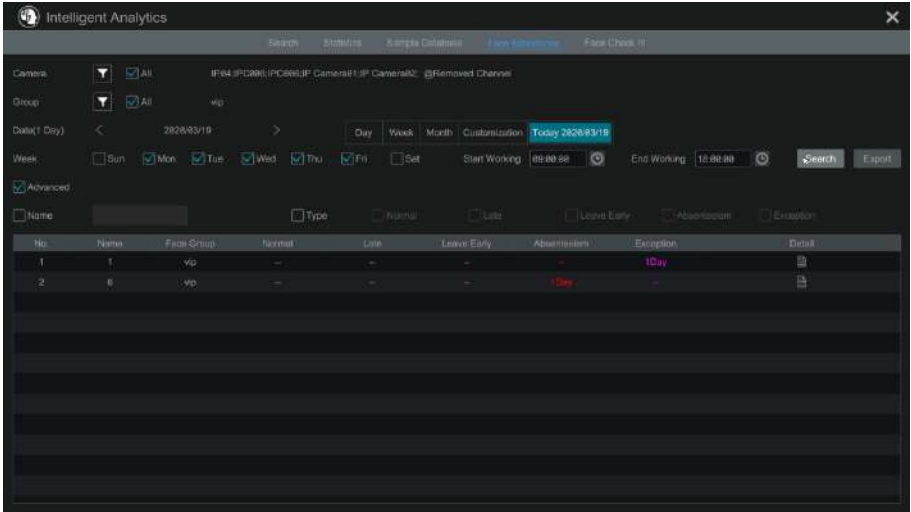



To search attendance information

- ① Click  behind camera and group to choose the desired cameras and groups.
- ② Set the attendance date. You can choose day, week, month and today or customize the time period.
- ③ Set the start time and the end time of working.
- ④ Click "Search" to view the attendance state.

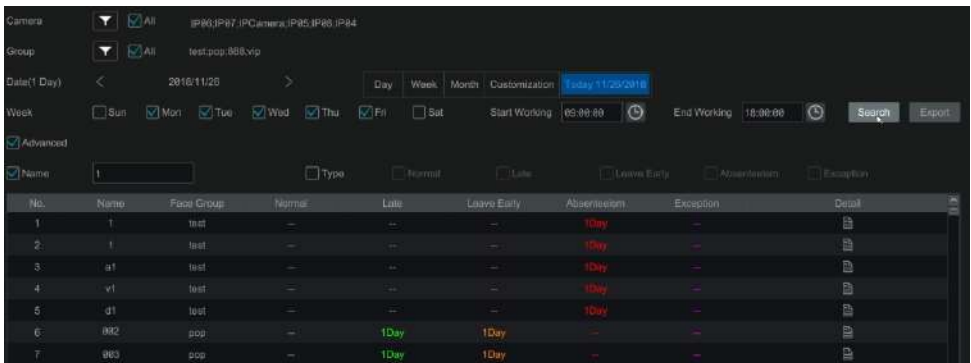
If some specific person's attendance state needs to know, you can click "Advanced" and then enter the name and choose the type



Click “Export” to export the searched attendance information.

Click  to view the detailed information of attendance. In this interface, click  to go to the face search interface.

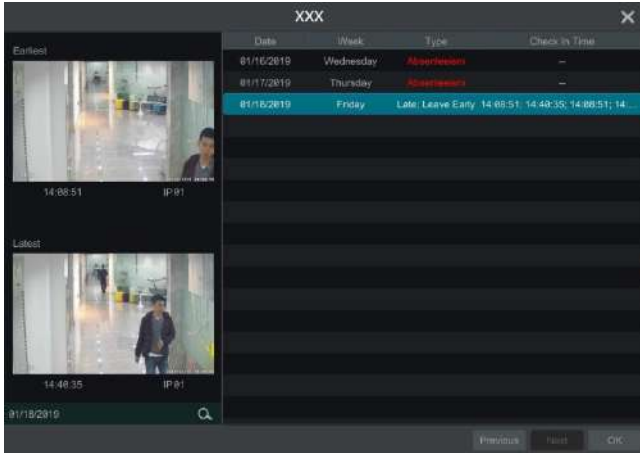



10.5 Face Check-In

Click Start→Intelligent Analytics→Face Attendance to go to the following interface. The search steps of face check-in are as follows.

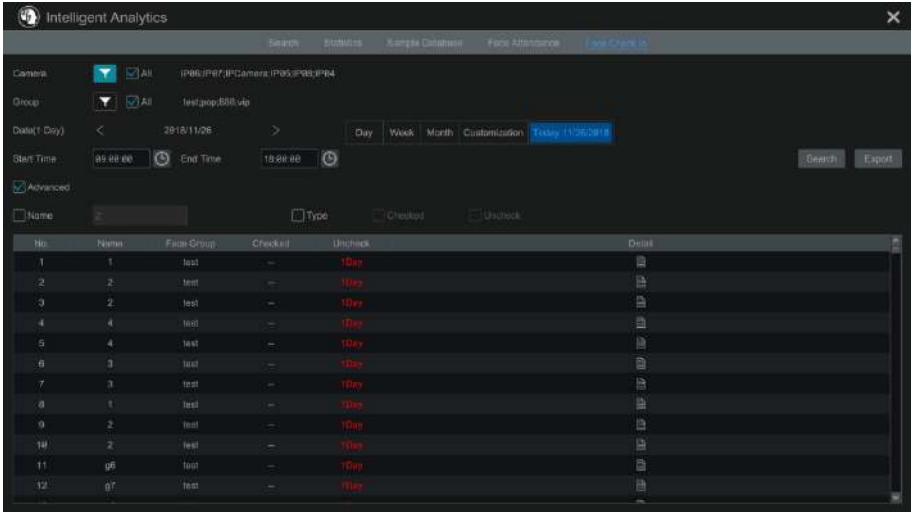
- ① Click  behind camera and group to choose the desired cameras and groups.
- ② Set the check-in date. You can choose day, week, month and today or customize the time period.
- ③ Set the start time and the end time of face check-in.
- ④ Click “Search” to view the check-in state.



If you want to know the detailed check-in information of someone, please click "Advanced" and then enter the name and choose the type to search. Click  to view the detailed information. In this interface, the checked image can be viewed. Click  to view the registered face picture of this person.

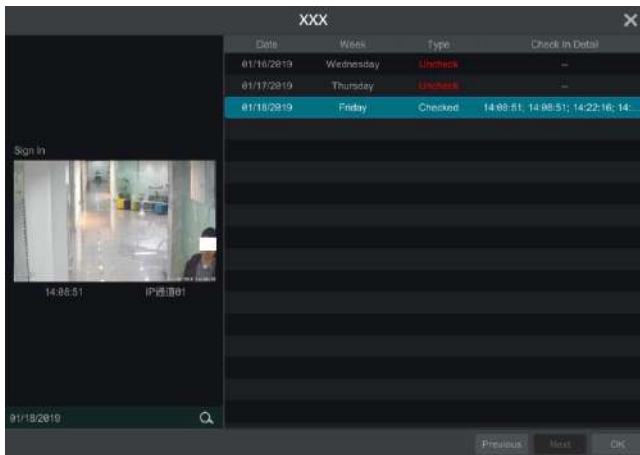

11 General Event Management

11 General Event Management

11.1 Sensor Alarm

To complete the entire sensor alarm settings, you should enable the sensor alarm of each camera and then set up the alarm handling of each camera.

① Click Start→Settings→Alarm→Sensor to go to the following interface.

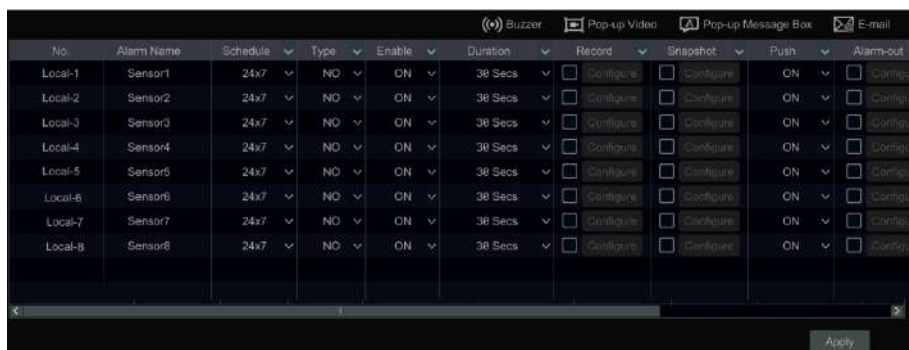

No.	Alarm Name	Schedule	Type	Enable	Duration	Record	Snapshot	Push	Alarm-out
Local-1	Sensor1	24x7	NO	ON	38 Secs	<input type="checkbox"/> Configure	<input type="checkbox"/> Configure	ON	<input type="checkbox"/> Configure
Local-2	Sensor2	24x7	NO	ON	38 Secs	<input type="checkbox"/> Configure	<input type="checkbox"/> Configure	ON	<input type="checkbox"/> Configure
Local-3	Sensor3	24x7	NO	ON	38 Secs	<input type="checkbox"/> Configure	<input type="checkbox"/> Configure	ON	<input type="checkbox"/> Configure
Local-4	Sensor4	24x7	NO	ON	38 Secs	<input type="checkbox"/> Configure	<input type="checkbox"/> Configure	ON	<input type="checkbox"/> Configure
Local-5	Sensor5	24x7	NO	ON	38 Secs	<input type="checkbox"/> Configure	<input type="checkbox"/> Configure	ON	<input type="checkbox"/> Configure
Local-6	Sensor6	24x7	NO	ON	38 Secs	<input type="checkbox"/> Configure	<input type="checkbox"/> Configure	ON	<input type="checkbox"/> Configure
Local-7	Sensor7	24x7	NO	ON	38 Secs	<input type="checkbox"/> Configure	<input type="checkbox"/> Configure	ON	<input type="checkbox"/> Configure
Local-8	Sensor8	24x7	NO	ON	38 Secs	<input type="checkbox"/> Configure	<input type="checkbox"/> Configure	ON	<input type="checkbox"/> Configure

- ② Select the alarm type (NO or NC) according to trigger type of the sensor.
- ③ Enable the sensor alarm of each camera and select the schedule.
- ④ Check the "Duration", "Record", "Snapshot", "Push", "Alarm-out" and "Preset" and enable or disable the "Buzzer", "Pop-up Video", "Pop-up Message Box" and "E-mail" as required.
- ⑤ Click "Apply" to save the settings.

The configuration steps of the above mentioned alarm linkages are as follows.
Duration: it refers to the interval time between the adjacent motion detections. For instance, if the duration time is set to 10 seconds, once the system detects a motion, it will go to alarm and would not detect any other motion (specific to camera) in 10 seconds. If there is another motion detected during this period, it will be considered as continuous movement; otherwise it will be considered as a single motion.

Record: check it and then the "Trigger Record" window will pop up automatically (you can also click the "Configure" button to pop up the window). Select camera on the left side and then click  to set the camera as the trigger camera.

Select trigger camera on the right side and then click  to cancel the trigger camera. Click "OK" to save the settings. The trigger cameras will record automatically when the sensor alarm is triggered.

Snapshot: check it and then the "Trigger Snapshot" window will pop up automatically. Configure the trigger camera in the window. The trigger cameras will capture images automatically when the sensor alarm is triggered.

Push: check it and choose ON or OFF. If it is ON, the system will send messages when the sensor alarm is triggered.

Alarm-out: check it and then the "Trigger Alarm-out" window will pop up automatically. Configure the trigger alarm-out in the window. The system will trigger the alarm-out automatically when the sensor alarm is triggered. You need to set the delay time and the schedule of the alarm outputs. See [11.5.1 Alarm-out](#) for details.

Preset: check it and then the "Trigger Preset" window will pop up automatically. Configure the trigger preset of each camera. To add presets, please see [6.2 Preset Setting](#) for details.

Buzzer: if enabled, the system will begin to buzz when the sensor alarm is triggered. To set the delay time of the buzzer, please see [11.5.4 Buzzer for details](#).

Pop-up Video: After camera setting, the system will pop up the corresponding video automatically when the sensor alarm is triggered. To set the duration time of the video, please see [11.5.3 Display](#) for details.

Pop-up Message Box: if enabled, the system will pop up the corresponding alarm message box automatically when the sensor alarm is triggered. To set the duration time of the message box, please see [11.5.3 Display](#) for details.

E-mail: if enabled, the system will send an e-mail when the sensor alarm is triggered. Before you enable the email, please configure the recipient's e-mail address first (see [13.1.5 E-mail Configuration](#) for details).

Virtual alarm: This function should be used with API server. If you want to enable it, please make sure the API Server is enabled first (Start→Network→Port) and then set the authentication as "Digest".

11.2 Motion Alarm

Motion Alarm: when the motion object appears in the specified area, it will trigger the alarm. You should enable the motion of each camera first and then set the alarm handling of the camera to complete the whole configuration of the motion alarm.

11.2.1 Motion Configuration

① Click Start→Settings→Camera→Motion Settings to go to the following interface.



② Select the camera, enable the motion and set the sensitivity and duration of the camera.

Sensitivity: the higher the value is, the more sensitive it is to motion. You should adjust the value according to the practical conditions since the sensitivity is influenced by color and time (day or night).

Duration: it refers to the interval time between the adjacent motion detections. For instance, if the duration time is set to 10 seconds, once the system detects a motion, it will go to alarm and would not detect any other motion (specific to camera) in 10 seconds. If there is another motion detected during this period, it will be considered as continuous movement; otherwise it will be considered as a single motion.

③ Drag the camera image to set the motion area. You can set more than one motion area. Click "All" to set the whole camera image as the motion area. Click "Reverse" to swap the motion area and the non-motion area. Click "Clear" to clear all the motion areas.

④ Click "Apply" to save the settings. Click "Processing Mode" to go to the alarm handling configuration interface of the motion alarm.

11.2.2 Motion Alarm Handling Configuration

① Click Start→Settings→Alarm→Motion Alarm to go to the following interface.



- ② Enable or disable "Record", "Snapshot", "Push", "Alarm-out", "Preset", "Buzzer", "Pop-up Video" and "E-mail". The alarm handling setting of motion alarm is similar to that of the sensor alarm (see [11.1 Sensor Alarm](#) for details).
- ③ Click "Apply" to save the settings. You can click "Motion Settings" to go to the motion configuration interface.

11.3 Combination Alarm

- ① Click Start→Settings→Alarm→Combination Alarm to go to the following interface.
- ② Customize combination alarm. Set alarm name and click "Configure" under the Combined Alarm Configuration item. Then select alarm type and alarm source. Finally, click "OK" to save the settings.
- ③ Enable or disable "Record", "Snapshot", "Push", "Alarm-out", "Preset", "Buzzer", "Pop-up Video" and "E-mail". The alarm handling setting of combination alarm is similar to that of the sensor alarm (see [11.1 Sensor Alarm](#) for details).
- ④ Click "Apply" to save the settings.

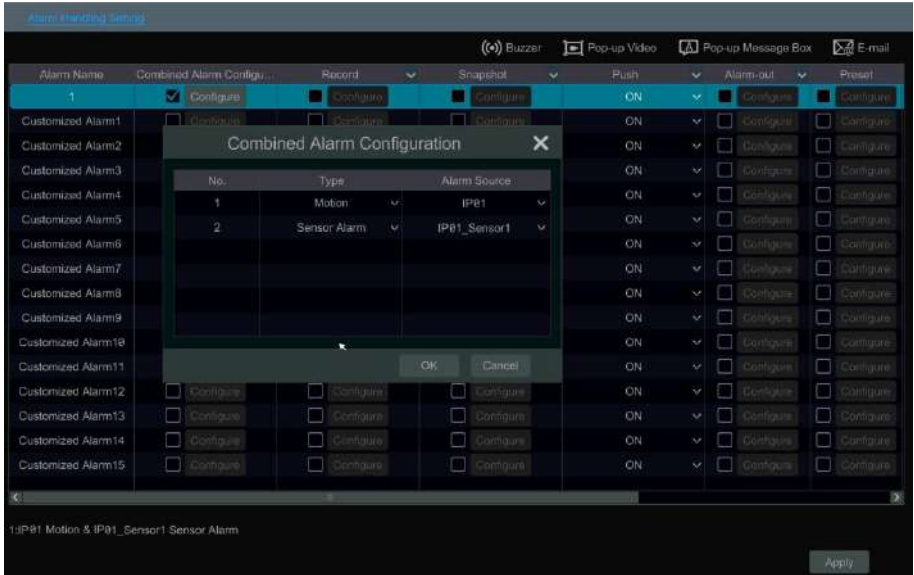

11.4 Exception Alarm

11.4.1 IPC Offline Settings

① Click Start→Settings→Camera→Motion Settings to go to the following interface.

① Click Start→Settings→AI/Event→IPC Offline Settings to go to the interface as shown below.

② Enable or disable “Snapshot”, “Push”, “Alarm-out”, “Preset”, “Buzzer”, “Pop-up Video”, “Pop-up Message Box” and “E-mail”. The IPC Offline Settings are similar to that of the sensor alarm (see [11.1 Sensor Alarm](#) for details).

③ Click “Apply” to save the settings.

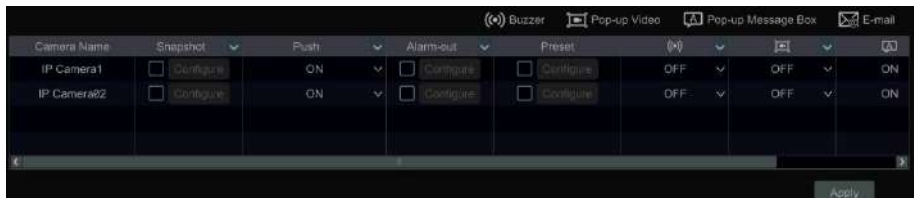

11.4.2 Exception Alarm Settings

① Click Start→Settings→Al/Event→Exception Alarm to go to the interface as shown below.

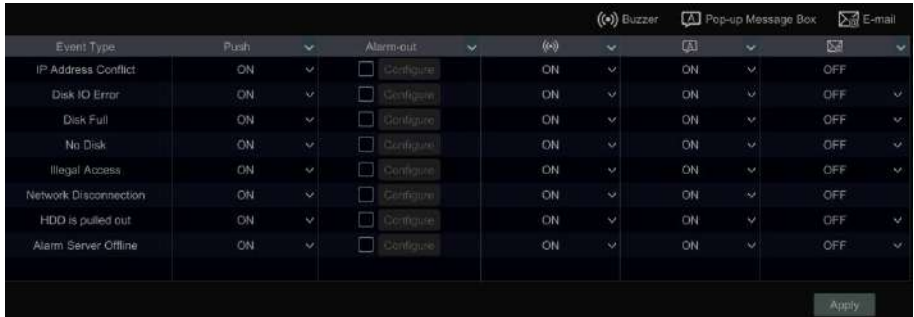

② Enable or disable “Push”, “Alarm-out”, “Buzzer”, “Pop-up Message Box” and “E-mail”. The exception handling settings are similar to that of the sensor alarm (see [11.1 Sensor Alarm](#) for details).

③ Click “Apply” to save the settings.

11.5 Alarm Event Notification

11.5.1 Alarm-out

① Click Start→Settings→Al/Event→Event Notification to go to the following interface.

No.	Name	Delay	Schedule	Test
Local-1	AlarmOut1	10 Secs	24x7	Test
Local-2	AlarmOut2	10 Secs	24x7	Test
Local-3	AlarmOut3	10 Secs	24x7	Test
Local-4	AlarmOut4	10 Secs	24x7	Test
IP Camera93-1	AlarmOut1	10 Secs	24x7	Test

② Set the delay time and the schedule of each alarm-out. You can click “Edit Schedules” to edit the schedules (see [7.1.2 Schedule Settings](#) for details).

③ Click “Apply” to save the settings. You can click “Test” to test the alarm output.

11.5.2 E-mail

Click Start→Settings→AI/Event→Event Notification→E-mail to go to the e-mail configuration interface. Set the e-mail address of the recipients. See [13.1.5 E-mail Configuration](#) for details.

11.5.3 Display

Click Start→Settings→AI/Event→Event Notification→Display to go to the display configuration interface. Set the duration time of the pop-up video and the pop-up message box. If your device supports two outputs, please set the output of the pop-up video as needed. After that, click "Apply" to save the settings.

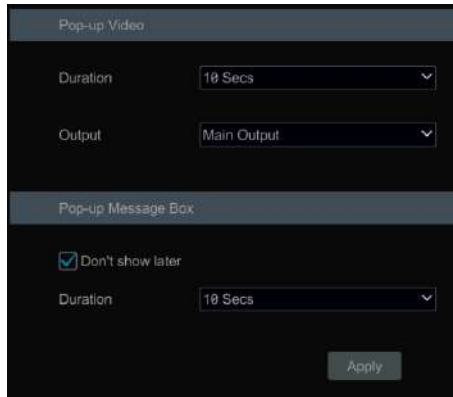

11.5.4 Buzzer

Click Start→Settings→AI/Event→Event Notification→Buzzer to go to the buzzer configuration interface. Set the delay time of the buzzer and then click "Apply" to save the setting. You can click "Test" to test the buzzer.

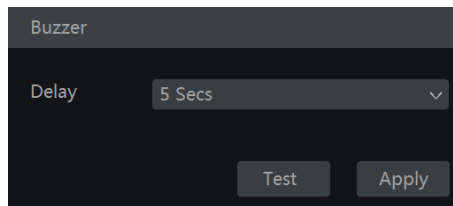

11.5.5 Push Message

Click Start→Settings→AI/Event→Event Notification→Push Message to go to the interface as shown below. Check "Enable" and then click "Apply" to save the settings. If Push Server is online, it will push messages to the mobile clients.

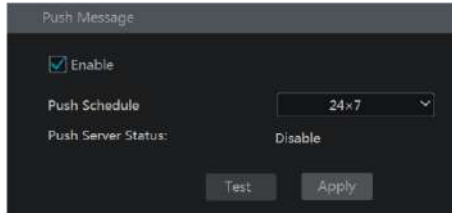

11.5.6 Audio

Click Start→Settings→AI/Event→Event Notification→Audio to go to the interface as shown below.

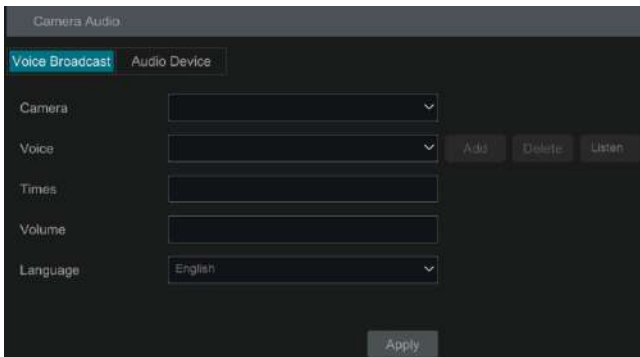

Camera audio settings:

For perimeter alert cameras, voice broadcast can be set up. Select the camera, voice, broadcast times, volume and language. Then click "Apply" to save the settings. When an alarm is triggered, camera will broadcast the voice you set.

Voice: click "Add" to add the alarm voice in wav. format. Click "Listen" to listen to the uploaded audio.

Click "Audio Device" to set the audio of the camera.

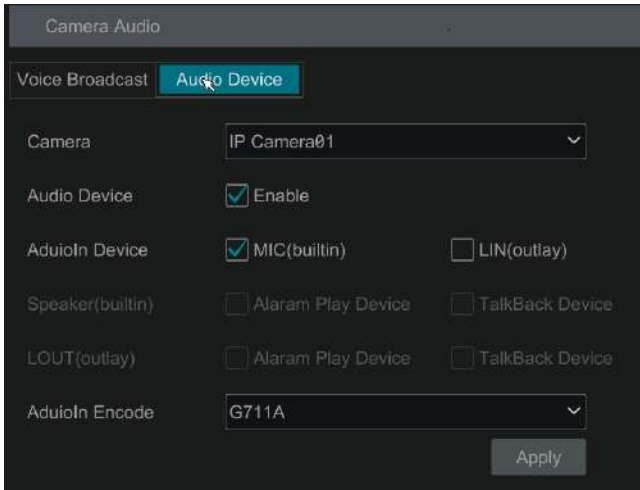

Select the camera and then enable audio device.

Audio In Device: Please select it according to the actual device configuration.
Speaker (built-in): Please select its function as needed.

LOUT: external audio output device, please select its function as needed.

Audio Input Encode: G711A/G711U

Local Audio Alarm

Set the audio alarm of local NVR.

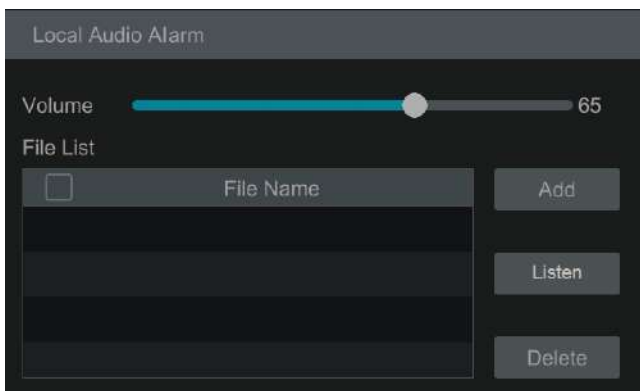

In this interface, you can set the volume of local audio. Click "Add" to upload the audio file. Choose the uploaded audio file and then click "Listen" to listen to it; click "Delete" to delete this file.

11.5.7 Light

Click Start→Settings→Alarm→Event Notification→Light to go to the interface as shown below. In this interface, you can set the light flashing time and frequency when an alarm is triggered.

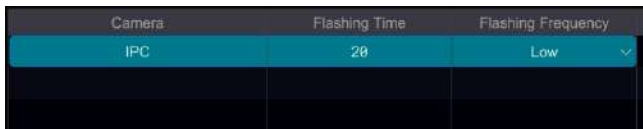

11.5.8 Alarm Server

Go to Alarm→Alarm Server interface as shown below.

Enable the alarm server and enter server address and port of the alarm server. Then select protocol. If "Send Heartbeat" is enabled, set the interval times. After that, test the effectiveness of the alarm server. Having tested successfully, please click "Apply". When an alarm occurs, the device will transfer the alarm event to the alarm server. If an alarm server is not needed, there is no need to configure this section.

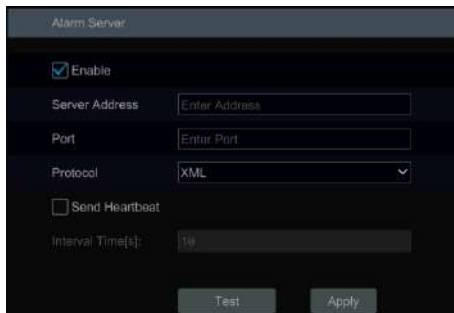

11.6 Manual Alarm

Click  on the tool bar at the bottom of the live preview interface to pop up a window. Click "Trigger" to start alarm. Click "Clear" to stop alarm.







11.7 View Alarm Status

Click Start→Settings→Alarm→Alarm Status or click  on the tool bar at the bottom of the live preview interface to view the alarm status.

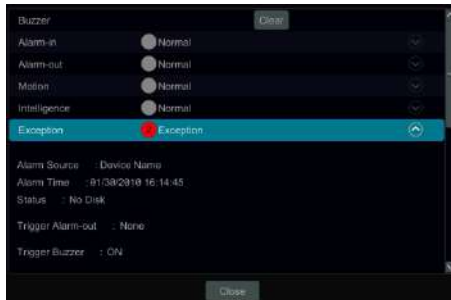

Click "Clear" to stop the buzzer when the buzzer alarm happens. Click  to view the detail information as shown below.



If the exception information is more than one page, you can enter the number in the box and then click  to jump to the specified page. Click  /  to view the exception alarm information in the previous/next page.

12 Account & Permission Management

12 Account & Permission Management

12.1 Account management

Click Start→Settings→Account and Authority→Account→Edit User to go to the interface as shown below.

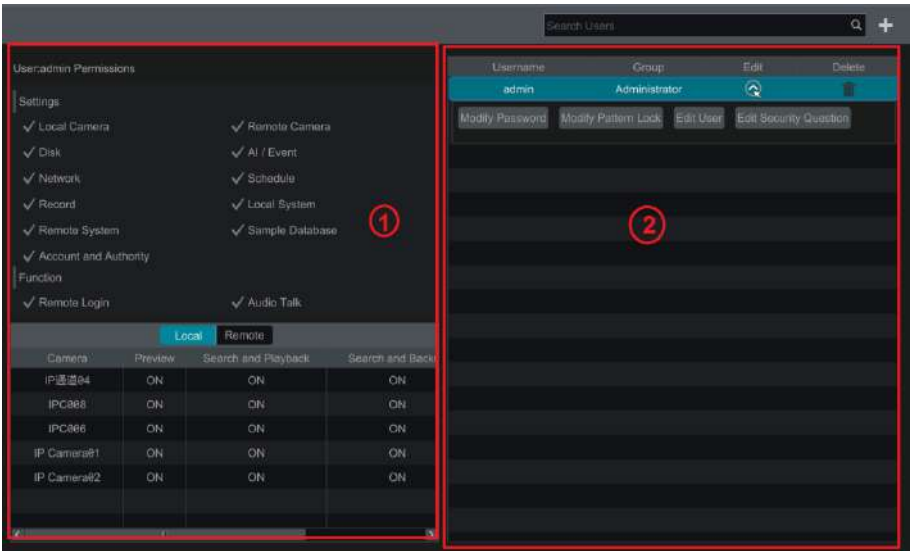

Area ① displays the user permissions. Area ② displays the user list. Click the user in the list to display its user permissions in area ①.

There are three default permission groups ("Administrator", "Advanced" and "Common") available when adding accounts. You can manually add new permission group (see [12.3.1 Add Permission Group](#) for details).



Only admin and the users that have the "Account and Authority" permission can manage the system's accounts. Group "Administrator" owns all the permissions displayed in area ① except "Account and Authority" and its permissions cannot be changed while the permissions of "Advanced" and "Common" can be changed.





12.1.1 Add User

① Click Start→Settings→Account and Authority→Account→Add User or click beside the search box to pop up the window as shown below.

② Set the username, password and group. User can also set the pattern lock here. The e-mail address and MAC address are optional (enter the MAC address after you check it). Click "Add" to add the user.

12.1.2 Edit User

Click Start→Settings→Account and Authority→Account→Edit User and then click  in the user list or double click the user to edit the user information. Click  to delete the user (the user admin cannot be deleted).

Username	Group	Edit	Delete
admin	Administrator		
<div style="display: flex; justify-content: space-around;"> Modify Password Modify Pattern Lock Edit User Edit Security Question </div>			
1	Administrator		
<div style="display: flex; justify-content: space-around;"> Edit User Recover Password </div>			

➤ **Edit Security Question**

You can set password security only for admin. Click “Edit Security Question” and then set questions and answers in the popup window. If you forget the password for admin, please refer to Q4 in [Appendix A FAQ](#) for details. The passwords of other users can be recovered by admin or the users that have the “Account and Authority” permission.

➤ **Modify Password**

Only the password of admin can be modified. Click “Modify Password” to pop up a window. Enter the current password and then set new password. Click “OK” to save the settings.

➤ **Modify Pattern Lock**

Some models may not support this function. Click “Modify Pattern Lock” to pop up a window.

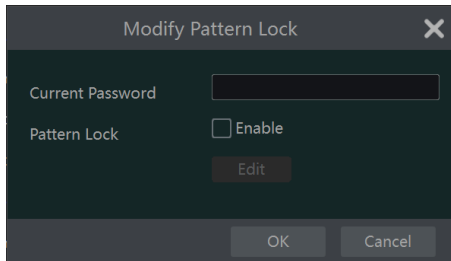

Input current password and then check “Enable” to set pattern lock.

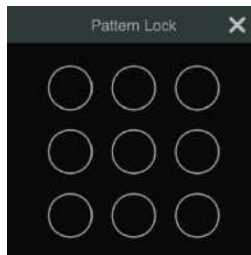

➤ **Recover Password**

Click “Recover Password” to reset the password to 123456.

➤ Edit User

Click "Edit User" to pop up the window as shown below. The admin is enabled, its permission control is closed and permission group cannot be changed by default. You can enable or disable other users (if disabled, the user will be invalid), open or close their permission control (if closed, the user will get all the permissions which admin has) and set their permission groups. Click "OK" to save the settings.

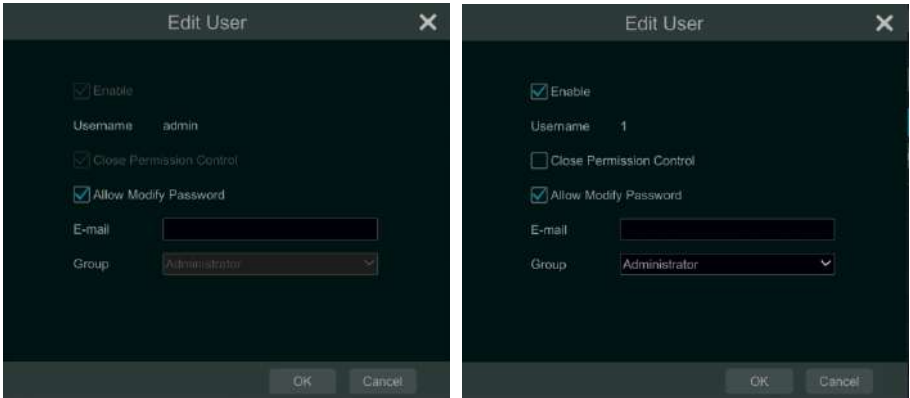

12.2 User Login & Logout

Login: Click Start→Login or directly click the preview interface and then select username and enter the password in the popup window. Click the "Login" button to log in the system.

Logout: Click Start→Logout or click Start→Shutdown to pop up the "Shutdown" window. Select "Logout" in the window and then click "OK" to log out the system.

12.3 Permission Management

12.3.1 Add Permission Group

Click Start→Settings→Account and Authority→Account→Edit Permission Group to go to the interface as shown below.

Group-Administrator Permissions

Settings

- ✓ Local Camera
- ✓ Remote Camera
- ✓ Disk
- ✓ AI / Event
- ✓ Network
- ✓ Schedule
- ✓ Record
- ✓ Local System
- ✓ Remote System
- ✓ Sample Database

Function

- ✓ Remote Login
- ✓ Audio Talk

Camera	Preview	Search and Playback	Search and Backu
IP 通道04	ON	ON	ON
IPC008	ON	ON	ON
IPC006	ON	ON	ON
IP Camera01	ON	ON	ON
IP Camera02	ON	ON	ON



Group: Administrator, Advanced, Common

Buttons: Edit, Save As, Delete

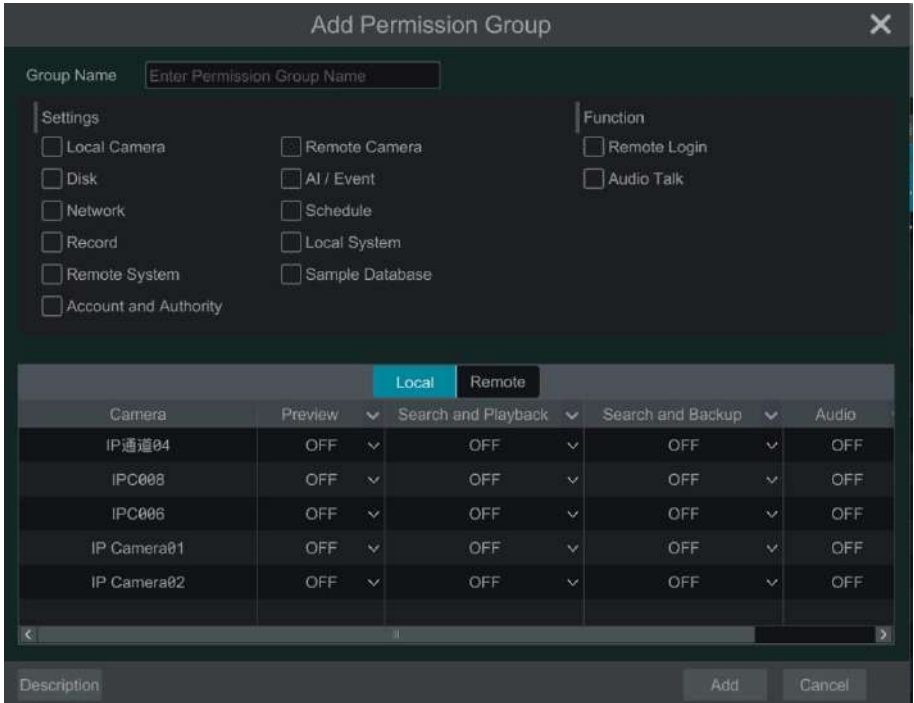
Click **+** to add permission group. Set the group name, check the permissions as required and then set the "Local" and "Remote" permissions. Click "Add" to save the settings.





12.3.2 Edit Permission Group

Go to "Edit Permission Group" interface and then click  in the group list to edit the permission group (the operations of the "Edit Permission Group" are similar to that of the "Add Permission Group", please see [12.3.1 Add Permission Group](#) for details). Click  to save the group as another group. Click  to delete the permission group. The three default permission groups ("Administrator", "Advanced" and "Common") cannot be deleted.

12.4 Black and White List

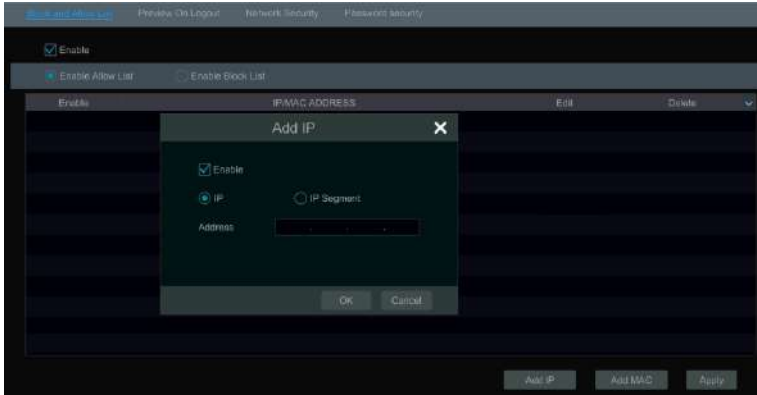
① Click Start→Settings→Account and Authority→Security to go to the following interface.



- ② Check "Enable" and then choose "Enable Allow List (white list)" or "Enable Block List (black list)" (the PC client of which the IP address is in the white list can access NVR remotely while the PC client in the black list cannot).
- ③ Add IP/IP segment/MAC. Click "Add IP" or "Add MAC" and then check "Enable" in the popup window (only if you check it can the IP/IP segment/MAC you add be effective). Enter the IP/IP segment/MAC and then click "OK". In the above interface, click  to edit IP/IP segment/MAC, click  to delete it. Click "Apply" to save the settings.

12.5 Preview On Logout

Click Start→Settings→Account and Authority→Security→Preview on Logout to go to the following interface.

Set a camera and then enable or disable the preview permission on logout as required. If a camera's preview permission on logout is "ON", you can view the live image of the camera when the system is logged out, or the live image of the camera cannot be seen when logged out.



12.6 Network Security

Click Start→Settings→Account and Authority→Security→Network Security to go to the following interface. You can enable APR Guard.



ARP Guard: Address Resolution Protocol Guard. This function can protect the LAN from APR attack and make the network run stably. If it is enabled, you can enable auto gateway MAC or manually set gateway MAC. Additionally, detection defense also can be enabled as needed.

12.7 Password Security

Click Start→Settings→Account and Authority→Security→Password Security to go to the following interface.



In this interface, you can set the level and expiration time of the password.

12.8 View Online User

Click Start→Settings→Account and Authority→User Status to view the online user information (you can view the online user name, login type, IP address and login time; click  to pop up a window showing the preview occupied channel number and playback occupied channel number).

13 Device Management

13.1 Network Configuration

13.1.1 Tcp/IP Configuration

Click Start→Settings→Network→TCP/IP to go to the following interface. Check "Obtain an IPv4 address automatically", "Obtain an IPv6 address automatically" and "Obtain DNS automatically" to get the network addresses automatically, or manually enter the network addresses. You can modify the MTU value according to the network condition (MTU, Maximum Transmission Unit, can be modified according to network condition for higher network transmission efficiency). Click "Apply" to save the settings.

The screenshot displays the 'IP Address Settings' window for 'Ethernet Port 1 (Online)'. It features several sections:

- IPv4 Settings:** Includes a checked checkbox for 'Obtain an IPv4 address automatically'. Below it are input fields for 'Address' (192.168.7.194), 'Subnet Mask' (255.255.255.0), and 'Gateway' (192.168.7.1). An 'MTU' field is set to 1500 with an 'Advanced' button next to it.
- IPv6 Settings:** Includes a checked checkbox for 'Obtain an IPv6 address automatically'. Below it are empty input fields for 'Address', 'Mask Length', and 'Gateway'.
- DNS Settings:** Includes a checked checkbox for 'Obtain DNS automatically'. Below it are empty input fields for 'Preferred DNS' and 'Alternate DNS'.
- Buttons:** An 'Apply' button is located in the bottom right corner.

Note:

- **Internal Ethernet Port**

If you use the NVR with the PoE network ports, click "Internal Ethernet Port" to go to the following interface.

The internal Ethernet port is the port which is used to connect all the PoE ports with the NVR system. The PoE ports are available if the internal Ethernet port is online; if it is offline, all the PoE ports will be unavailable, maybe the internal Ethernet port is broken.

The network addresses of the internal Ethernet port can be changed to make the port in the same network segment with the IP cameras which are directly connected to the PoE ports of the NVR (it is not recommended to change the network addresses of the internal Ethernet port).

Mode: Non-long line mode or long line mode can be selectable. The non-line mode is the default setting. If the transmission performance of your network cables connected the PoE ports and IPC are not so good or these network cables are very long, you can choose long line mode.

The screenshot shows the 'IP Address Settings' window for 'Internal Ethernet Port 1 (Online)'. The interface includes the following fields and options:

- Address:** 192 . 168 . 76 . 1 (with a secondary address field containing fe80::ffff:192:168:78:1)
- Subnet Mask:** 255 . 255 . 255 . 0 (with a secondary Mask Length field set to 64)
- Mode:** Non-long line mode (selected from a dropdown menu)
- Obtain DNS automatically
- Preferred DNS:** [Empty text field]
- Alternate DNS:** [Empty text field]
- Apply** button

● Multiple Ethernet Ports Setting

If the NVR has two network ports or above, you can select the network work pattern as required.

TOE: It is a technology for improving the network transmission speed. Please enable it according to the actual network situation. If TOE is enabled, it shall be high speed mode. Then multiple address setting or network fault tolerance can be chosen and configured. If TOE is not enabled, it shall be compatible mode. Then the network fault tolerance cannot be selected and set up.

Network Fault Tolerance: The two network ports will be bound to one IP address if you select the "Network Fault Tolerance" pattern. There are many advantages of this work pattern: 1. increase the bandwidth; 2. form a network redundant array to share the load. When a failure happens to one network port, the other port will take over the entire load immediately. The takeover process is seamless and the network service will not be broken off.

Refer to the figure as shown below. If “Network Fault Tolerance” is selected, check “Obtain an IPv4 address automatically”, “Obtain an IPv6 address automatically” and “Obtain DNS automatically” to get the network addresses automatically, or manually enter the network addresses; select one Ethernet port as the primary card and then click “Apply” to save the settings.

The screenshot displays the "IP Address Settings" configuration window. At the top, "TOE Enable" is checked with a note "(Modifying toe status need to reboot)". Below it, "Work Pattern" is set to "Network Fault Tolerance" with a note "(Modifying work pattern need to reboot)".

Under the "Obtain an IPv4 address automatically" section, the "Obtain an IPv4 address automatically" checkbox is checked. The fields for Address (192.168.3.30), Subnet Mask (255.255.255.0), Gateway (192.168.0.1), and MTU (1500) are visible. The "Obtain an IPv6 address automatically" checkbox is also checked, with empty fields for Address, Mask Length, and Gateway.

The "Primary Card" is set to "Ethernet Port 1". Below this, "Ethernet Port 1 (Online)" has a MAC Address of 08:00:27:00:00:45. "Ethernet Port 2 (Offline)" has a MAC Address of 08:00:27:00:00:08.

At the bottom, "Obtain DNS automatically" is checked, with empty fields for Preferred DNS and Alternate DNS. An "Apply" button is located in the bottom right corner.

Multiple Address Setting: If “Multiple Address Setting” is selected, the IP addresses of the two Ethernet ports should be set respectively. Refer to the picture as shown below.

Check “Obtain an IPv4 address automatically”, “Obtain an IPv6 address automatically” and “Obtain DNS automatically” to get the network addresses automatically, or manually enter the network addresses; select one Ethernet port as the default route and then click “Apply” to save the settings.

IP Address Settings

TOE Enable (Modifying toe status need to reboot)

Work Pattern: Multiple Address Setting (Modifying work pattern need to reboot)

Ethernet Port 1 (Online) | Ethernet Port 2 (Offline)

Obtain an IPv4 address automatically

Address: 192.168.0.36
Subnet Mask: 255.255.240.0
Gateway: 192.168.0.1
MTU: 1500

Obtain an IPv6 address automatically

Address: _____
Mask Length: _____
Gateway: _____

Obtain DNS automatically

Preferred DNS: _____
Alternate DNS: _____
Default Route: Ethernet Port 1

Apply

13.1.2 Port Configuration

Click Start→Settings→Network→Port to go to the interface as shown below. Enter the HTTP port, HTTPS port, server port and POS port of the NVR, and then click "Apply" to save the settings. You can also enable and set RTSP port (please check "Anonymous" as required).

Port

HTTP Port: 80

HTTPS Port: 443 Enable

Server Port: 6036

POS Port: 9036

API Server

Enable

Authentication: Digest

RTSP Port: 554 Anonymous

Apply

HTTP Port: the default HTTP port of the NVR is 80. The port number can be changed to others like 81. The port is mainly used to web client access. If you want to access the NVR through a web browser, you should enter IP address plus HTTP port in the address bar of the web browser like `http://192.168.11.61:81`.

HTTPS Port: the default HTTPS port of the NVR is 443.

HTTPS provides authentication of the web site and protects user privacy. How to use it?

① Enter IP address plus HTTP port in the address bar of the web browser. Then enter username and password to log in. Click Functional Panel→Network→HTTPS to go to the following interface.



② Install a certificate.

* You can create a private certificate here. Click the "Create" button to create a private certificate. Enter the country (only two letters available), domain (NVR's IP address/domain), validity date, password, province/state, region and so on. Then click "OK" to save the settings.

* If there is a signed certificate, click "Browse" to select it and then click "Install" to install it.

* Click "Create a certificate request" to enter the following interface.

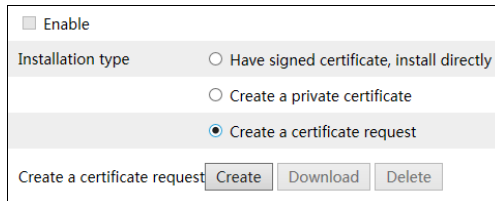

Click "Create" to create the certificate request. Then download the certificate request and submit it to the trusted certificate authority for signature. After receiving the signed certificate, import the certificate to the device.

③ After the certificate has been installed, enable this function and apply it. Then the camera can be accessed by entering `https://IP: https port` via the web browser (eg. `https://192.168.1.201:443`).

Server Port: the default server port of the NVR is 6036. The server port number can be changed as required. The port is mainly used in network video management system.

POS Port: the default POS port of the NVR is 9036.

Note: The HTTP port and server port of the NVR should be mapped to the router before you access the NVR via WAN.

API Server: You can log in the media player which supports the RTSP protocol by the username and password here. Moreover, the third-party can further develop through API service.

Authentication: Basic authentication and digest authentication are optional.

RTSP Port: RTSP real-time stream protocol can be used to control the sending of real-time data. By media player (like VLC player) which supports the RTSP real-time stream protocol, you can view the live images synchronously. The default RTSP port is 554 and it can be changed as needed. (The address format: `rtsp://IP address:554/chID=1&streamType=main` or `rtsp://IP address:554/chID=1&streamType=sub`; main indicators main stream; sub indicators sub stream; chID indicators channel ID).

Examples: ① Enable RTSP and "Anonymous". Then open the VLC player and enter the address (for example: `rtsp://192.168.1.88:554/chID=1&streamType=-main`) in the network address bar of the VLC player. Then you can view the video of channel 1. ② Enable RTSP and open the VLC player. After that enter the address (for example: `rtsp://192.168.1.88:554/chID=1&streamType=sub`) in the network address bar of the VLC player. Then a login box will pop up. Enter the username and password which shall be as the same as the username and password of API server. Then you can view the video of channel 1.

If your NVR is a PoE NVR, you can also enable virtual host in the port setting interface via Web Client. After this function is enabled, the web settings interface of NVR can be jumped to the web client of the IPC. The setting steps are as follows.

1. Please login the Web Client of NVR (See [14.2 Web LAN Access](#) or [14.3 Web WAN Access](#) for details). Click Settings→Network→Port to go to the following page. The picture is for reference only. The interface may be different for different devices.

HTTP Port	<input type="text" value="80"/>
HTTPS Port	<input type="text" value="443"/>
Server Port	<input type="text" value="6036"/>
POS Port	<input type="text" value="9036"/>
<input checked="" type="checkbox"/> Enable virtual host	
<input type="button" value="Apply"/>	

2. Check "Enable virtual host" and then click "Apply".

3. Click Camera→Edit Camera to go to the following interface.

No.	Camera Name	Type	Status	Device Model	Preview	Edit	Delete	Settings
1	IPC111	Thermal Network Camera	Offline	TE-5433C				
2	9941E1	IP Camera (Entry and Exit)	Offline	TD-9442E1				
3	IPCMB1	Facial Panel	Online	E211B				
4	IPC	Attendance Terminal	Offline	TD-9632E2				
5	IPB001	Attendance Terminal	Offline	SI-3MP				

4. Select the camera and click to log in the web client of the camera. Then you can set the parameters of the camera as needed.

13.1.3 PPPoE Configuration

Click Start→Settings→Network→PPPoE to go to the interface as shown below. Check "Enable" in "PPPoE Settings" and then enter the username and password obtained from the dealer. Click "Apply" to save the settings.

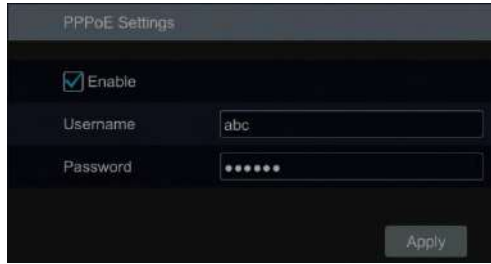

PPPoE Settings

Enable

Username: abc

Password: ●●●●●●

Apply

13.1.4 DDNS Configuration

The DDNS is used to control the dynamic IP address through domain name. You can access to the NVR easily if the DDNS is enabled and configured. Click Start→Settings→Network→DDNS to go to the interface as shown below.

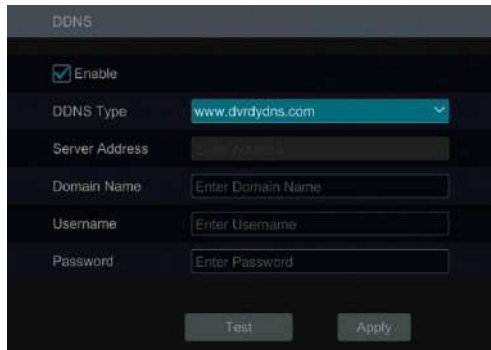

DDNS

Enable

DDNS Type: www.dvrddns.com

Server Address: [Empty]

Domain Name: Enter Domain Name

Username: Enter Username

Password: Enter Password

Test Apply

Check "Enable" and then select the DDNS type. Enter the server address, domain name, username and password according to the selected DDNS type. Click "Test" to test the effectiveness of the input information. Click "Apply" to save the settings.

You will have to enter the server address and domain name if some DDNS types are selected. Go to the relative DNS website to register domain name and then enter the registered domain information here). Now we take www.dvrddns.com for example.

- ① Enter www.dvrddns.com in the address bar to visit its DNS website.

② Click **Registration** to go to the interface as shown below. Set the DDNS account information (username, password and so on) and then click Submit to save the account.

③ Create domain name and then click **Request Domain**.

- ④ After you successfully request your domain name, you will see your domain name information in the list.

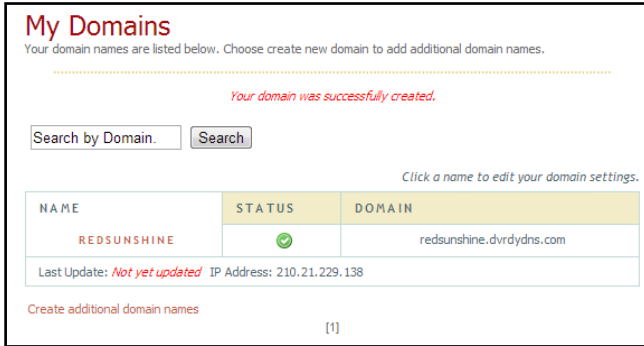

- ⑤ Click Start→Settings→Network→DDNS to go to DDNS setting interface. Enable DDNS and then select the www.dvrtdydns.com DDNS type. Enter the registered username, password and domain name and then click "Apply".
- ⑥ Map the IP address and HTTP port in the router (you can skip this step if UPnP function is enabled).
- ⑦ Enter the registered domain name plus HTTP port like http://www.xxx.dvrtdydns.com:81 in the address bar and then press Enter key to go to the web client.

13.1.5 E-mail Configuration

Click Start→Settings→Network→E-mail to go to the following interface.

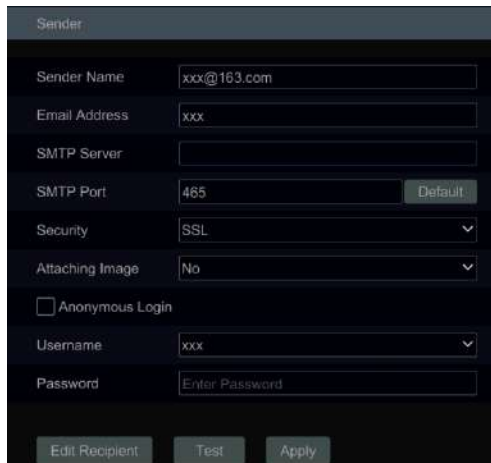

Enter the sender's name, e-mail address, SMTP server and SMTP port (you can click "Default" to reset the SMTP port to the default value) and then enable or disable the SSL and attaching image. Select the username (the username list will be updated automatically according to the email address you enter) and enter the password of the sender and then click "Apply" to save the settings (you don't have to enter the username and password if "Anonymous Login" is enabled).

Click "Test" to pop up a window. Enter the e-mail address of the recipient in the window and then click "OK". The e-mail address of the sender will send an e-mail to the recipient. If the e-mail is sent successfully, it indicates that the e-mail address of the sender is configured correctly.

Click "Edit Recipient" to go to the following interface.

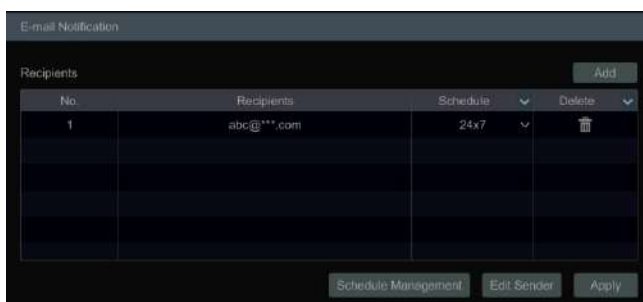

Click "Add" and then enter the recipient's e-mail address and select the schedule (if a schedule is selected, the system will send the alarm email and the recipient will receive it only in the selected schedule time) in the popup window. Click "Add" in the window to add the recipient. You can also change the recipient's receiving schedule by clicking in the "Schedule" column. Click to delete the recipient in the list. Click "Apply" to save the settings. Click "Edit Sender" to go to the e-mail configuration interface of the sender.

13.1.6 UPnP Configuration

By UPnP you can access the NVR through web client which is in WAN via router without port mapping.

- ① Click Start→Settings→Network→UPnP to go to the following interface.
- ② Make sure the router supports UPnP function and the UPnP is enabled in the router.
- ③ Set the NVR's IP address, subnet mask and gateway and so on corresponding to the router.
- ④ Check "Enable" in the interface as shown below and then click "Apply".

Click the “Refresh” button to refresh the UPnP status. If the UPnP status is “Invalid UPnP” after refreshing it a few times, the port number may be wrong. Please change the mapping type to “Manual” and then click  to modify the port until the UPnP status turns to “Valid UPnP”. Refer to the following picture. You can view the external IP address of the NVR. Enter the external IP address plus port in the address bar to access the NVR such as <http://183.17.254.19:81>.



Port Type	External Port	External IP Address	Port	UPnP Status	Edit
HTTP Port	88		88	Not Ready	
HTTPS Port	443		443	Not Ready	
Server Port	6936		6936	Not Ready	
RTSP Port	554		554	Not Ready	

13.1.7 802.1X

If it is enabled, the NVR data can be protected. When the NVR is connected to the network protected by the IEEE 802.1X, user authentication is needed.

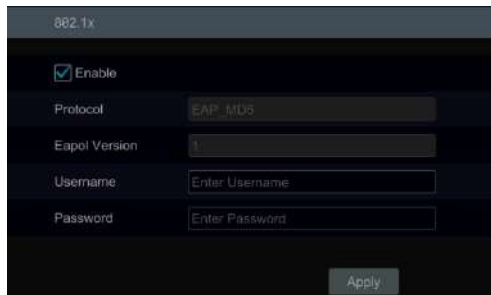

To use this function, the NVR shall be connected to a switch supporting 802.1x protocol. The switch can be considered as an authentication system to identify the device in a local network. If the NVR connected to the network interface of the switch has passed the authentication of the switch, it can be accessed via the local network.

Protocol type and EAPOL version: Please use the default settings.

User name and password: The user name and password must be the same with the user name and password applied for and registered in the authentication server.

13.1.8 NAT Configuration

Click Start→Settings→Network→NAT to go to the interface for NAT configuration. Check “Enable” and then select the NAT server address. Click “Apply” to save the settings.

You can scan the QRCode through mobile client which is installed in the mobile phone or tablet PC to log in the mobile client instantly.

Access Type: NAT or NAT2.0 can be selected.

Note: if you want to use cloud upgrade, you must enable NAT2.0.

13.1.9 FTP Configuration

Some models may not support this function.

Click Start→Settings→Network→FTP to go to the interface for FTP configuration. Check “Enable” and enter the server name, port, username and password, max file size and remote directory.

Please enable “Resume Uploading” as needed.

After that, you can choose the recorded files to upload as needed in this interface.

FTP									
<input checked="" type="checkbox"/> Enable									
Server Address:		Enter Address			Port:		21		
Username:		Enter Username			Password:		Enter Password <input type="checkbox"/> Anonymous		
Max File Size:		64			M		Remote Directory		
<input checked="" type="checkbox"/> Resume Uploading <small>Note: After FTP is successfully reconnected, the device will automatically upload the videos shot during FTP disconnection period.</small>									
Uploading Settings									
No.	Camera Name	Schedule	Motion	Uploading record				Uploading Image	
				Intelligence	Sensor	Exception Alarm	Stream Type	Snapshot	
1	IP 通道04	24x7	OFF	OFF	OFF	OFF	OFF	Sub Stream	OFF
2	IPC008	24x7	OFF	OFF	OFF	OFF	OFF	Sub Stream	OFF
3	IPC006	24x7	OFF	OFF	OFF	OFF	OFF	Sub Stream	OFF
4	IP Camera#1	24x7	OFF	OFF	OFF	OFF	OFF	Sub Stream	OFF
5	IP Camera#2	24x7	OFF	OFF	OFF	OFF	OFF	Sub Stream	OFF
<input type="button" value="Schedule Management"/> <input type="button" value="Test"/> <input type="button" value="Apply"/>									

13.1.10 Platform Access

Some models may not support this function.

This function is mainly used for connecting ECMS/NVMS. The setting steps are as follows. Click Start→Settings→Network→Platform Access to go to the interface.

Platform Access

Access Type: Platform Software

Enable

Server Address: 192.168.1.200

Port: 2009

Report ID: Enter Report ID

Report Status: Disable

Apply

Platform Access

- ① Set "Access Type" as "Platform Software" and select "Enable" as shown below.
- ② Check the IP address and port of the transfer media server in the ECMS/NVMS. The default server port for auto report is 2009. If it is modified, please go to the transfer media interface to check.
- ③ Enable the auto report in the ECMS when adding a new device. Then self-define device ID and complete the remaining information of the device in the ECMS/NVMS.
- ④ Enter the above-mentioned server address, port and report ID in the server interface. Then click "Apply" to save the settings. Now the ECMS/NVMS system will automatically connect this device.

UPnP Report Access

In this interface, you can also access the third-party platform by UPnP Report. If this one is enabled, please enter the server address, port and manufacturer ID.

13.1.11 SNMP

- ① Click Start→Settings→Network→SNMP to go to the interface for SNMP configuration.

- ② Check SNMPv1 or SNMPv2 to enable this function.
- ③ Set the port of the SNMP.
- ④ Set the trap address and the trap port.
- ⑤ Click "Apply" to save the settings.

Trap Address: The IP address of SNMP host.

Trap Port: The port of SNMP host.

Tips: Before setting the SNMP, please download the SNMP software and manage to receive the device information via SNMP port. By setting the trap address, the device is allowed to send the alarm event and exception message to the monitoring center.

13.1.12 View Network Status

Click Start→Settings→Network→Network Status to view the network status or click  on the tool bar at the bottom of the live preview interface to view network status conveniently.

13.2 Basic Configuration

13.2.1 Common Configuration

Click Start→Settings→System→Basic→General Settings to go to the following interface. Set the device name, device No., language, video format and main output. Enable or disable wizard, "Log In Automatically", "Log Out Automatically" (if checked, you can set the wait time), "App Live Self-Adaption" and "Dwell Automatically" (if checked, you can set the wait time). Click "Apply" to save the settings.

General Settings

Device Name

Device No.

Language

Video Format

Fixed display resolution

Main Output

Secondary Output

Enable Wizard

Log In Automatically

Log Out Automatically

Wait Time

App Live Self-adaption

Dwell Automatically

Wait Time

Apply

Device Name: The name of the device. It may display on the client end or CMS that help user to recognize the device remotely.

Video Format: Two modes: PAL and NTSC. Select the video format according to the camera.

Main Output: Enable "Fixed display resolution" and then select the main output as needed.

Note: You can set the resolutions of the main output and secondary output respectively if the NVR has dual outputs. Refer to the picture as shown below.

Dwell Automatically: Switch automatically. Check it and set "wait time".The system will switch images automatically if it is not operated during the time you set.

13.2.2 Date and Time Configuration

Click Start→Settings→System→Basic→Date and Time to go to the interface as shown below. Set the system time, date format, time format and time zone of the NVR. The default time zone is GMT+08 Beijing, Hong Kong, Shanghai, Taipei. If the selected time zone includes DST, the DST of the time zone will be checked by default. Click "Apply" to save the settings.

You can manually set the system time or synchronize system time with network through NTP.

Manual: select “Manual” in the “Synchronous” option and then click  after the “System Time” option to set the system time.

NTP: select “NTP” in the “Synchronous” option and then enter the NTP server.

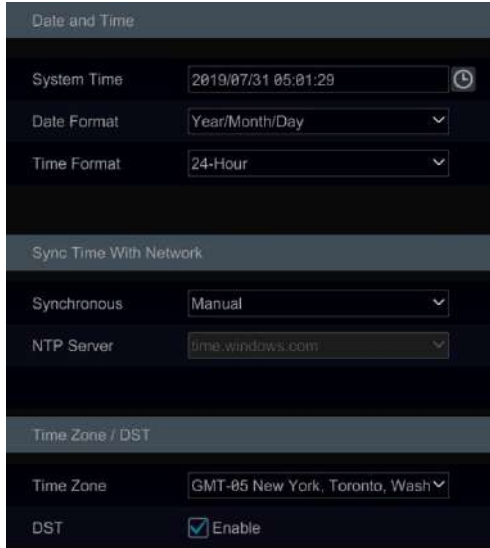

Date and Time	
System Time	2019/07/31 05:01:29 
Date Format	Year/Month/Day
Time Format	24-Hour
Sync Time With Network	
Synchronous	Manual
NTP Server	time.windows.com
Time Zone / DST	
Time Zone	GMT-05 New York, Toronto, Wash
DST	<input checked="" type="checkbox"/> Enable

13.2.3 Recorder OSD Settings

Click Start→Settings→System→Basic→Recorder OSD settings to go to recorder OSD setting interface. OSD name and icon can be enabled here.

13.3 Factory Default

Click Start→Settings→System→Maintenance→Factory Default to go to the following interface. Please choose the item as needed.

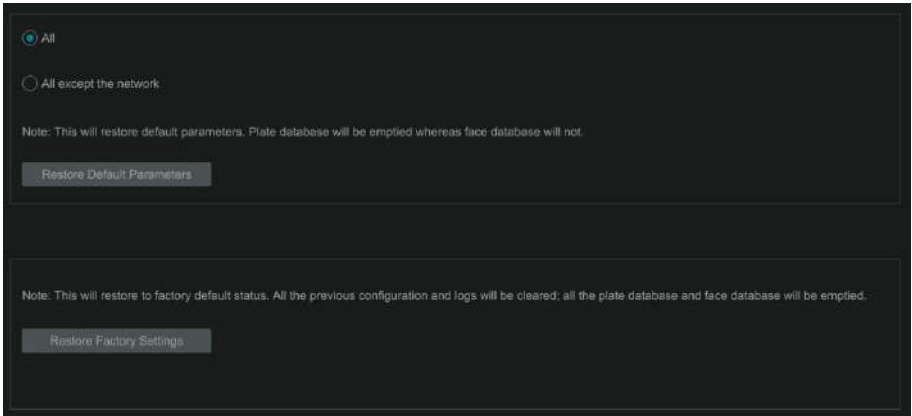

Note: Resetting to the factory default settings will not change time zone.

13.4 Device Software Upgrade

● Upgrade

You can click Start→Settings→System→Information→Basic to view MCU, kernel version and firmware version and so on. Before upgrade, please get the upgrade file from your dealer.

The upgrade steps are as follows:

- ① Copy the upgrade software (.tar) into the USB storage device.
- ② Insert the USB storage device into the USB interface of the NVR.
- ③ Click Start→Settings→System→Maintenance→Upgrade to go to "Upgrade" interface. Select the USB device in "Device Name" option and go to the path where the upgrade software exists. Select the upgrade software and then click "Upgrade". The system may automatically restart during upgrading. Please wait for a while and do not power off the NVR during upgrading.

Note: The file system of the USB mobile device which is used for upgrading, backing up and restoring

● Cloud Upgrade

Note: Before you use cloud upgrade, please enable NAT2.0.

- ① Click Start→Settings→Network→Cloud Upgrade as shown below.

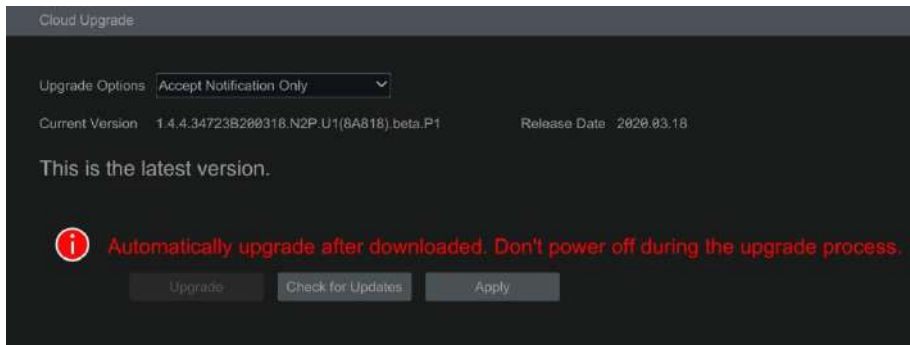

- ② Select "Accept Notification Only" or click "Check for Updates" to check whether the current version is the latest. If your software version is not the latest, click "Upgrade" to download and upgrade from the cloud server.
- ③ Please don't power off during the upgrade process.

13.5 Backup and Restore

You can back up the configuration file of the NVR by exporting the file to other storage devices; you can recover the configuration to other NVRs which are of the same model with the NVR by importing the configuration file to other NVRs for time saving.

Insert the USB storage device into the USB interface of the NVR and then click Start→Settings→System→Maintenance→Backup and Restore to go to the interface.

● Backup

Select the USB device in "Device Name" option; go to the path where you want to store the configuration backup file and then click "Backup"; finally click "OK" in the popup window.

● Recover

Select the USB device in "Device Name" option; find the configuration backup file and then click "Recover"; finally click "OK" in the popup window.





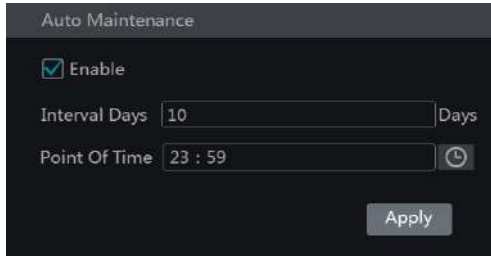









13.6 Restart Automatically



You can set the automatic restart time for the NVR to maintain it regularly. Click Start→Settings→System→Maintenance→Auto Maintenance to go to the interface as shown below. Enable auto maintenance, set the interval days and point of time and then click "Apply" to save the settings. The NVR will restart automatically at the pointed time every interval days.



13.7 View Log

Click Start→Settings→System→Maintenance→View Log to go to the log view interface. Select the log main type, click  to set start time and end time and then click "Search". The searched log files will be displayed in the list.

No.	Main Type	Log Time	Content	Details	Play
1	Alarm	11/03/2015 15:58:53	Motion Alarm		
2	Settings	11/03/2015 15:43:01	Local Basic		—
3	Operation	11/03/2015 15:34:53	Local Search/Playback/Backup		—
4	Alarm	11/03/2015 15:25:43	Motion Alarm		
5	Settings	11/03/2015 15:25:38	Local Camera Parameters		—
6	Operation	11/03/2015 15:20:15	Local Search/Playback/Backup		—
7	Settings	11/03/2015 15:05:38	Local Camera Parameters		—
8	Settings	11/03/2015 15:05:06	Local Record Parameters		—
9	Exception	11/03/2015 15:04:48	IPC Offline		—
10	Settings	11/03/2015 15:04:46	Local Camera Parameters		—
11	Operation	11/03/2015 15:03:49	Local Login / Logout		—
12	Operation	11/03/2015 15:03:12	Local Maintenance		—

Choose the log file in the list and then click "Export" button to export the log file. Click  on the "Content" title bar to pop up a menu list. Check contents in the menu list and then the log list will show the checked log contents only. Click  to play the video log.

13.8 View System Information

Click Start→Settings→System→Information and then click the corresponding menu to view the "Basic", "Camera Status", "Alarm Status", "Record Status", "Network Status" and "Disk" information of the system.

14 Remote Surveillance

14 Remote Surveillance

14.1 Mobile Client Surveillance

- ① Enable NAT in the NVR. Refer to [13.1.8 NAT Configuration](#) for details.
- ② Download and install the mobile client "SuperLive Plus" into the mobile device with the Android or iOS system.
- ③ Run the mobile client, go to the "Add Device" interface and then click  to scan the QRCode of the NVR (Go to Start→Settings→System→Information→Basic to view the QRCode of the NVR).
- ④ After scanning the QRCode successfully, enter the login password to log in mobile client.

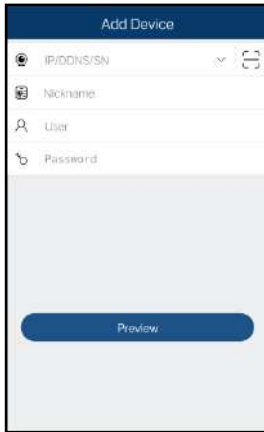

14.2 Web LAN Access

- ① Click Start→Settings→Network→TCP/IP to go to the "TCP/IP" interface. Set the IP address, subnet mask, gateway, preferred DNS and alternate DNS of the NVR.
- ② Open a web browser on your computer, enter the IP address of the NVR in the address bar and then press enter to go to the login interface as shown below. You can change the display language on the top right corner of the login interface. Enter the username and password of the NVR in the interface and then click "Login" to go to the live preview interface.

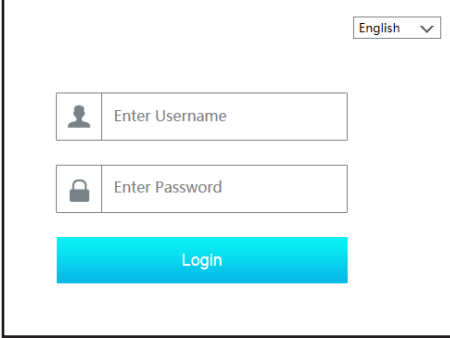

- Notes:*
- 1. Please make sure that the IP address of the NVR and the computer are both in the same local network segment. For example, supposing that the IP address of the computer is 192.168.1.41, the IP address of the NVR shall be set to 192.168.1.XXX.*
 - 2. If the HTTP port of the NVR is not 80, but other number instead, you need to enter the IP address plus port number in the address bar when accessing the NVR over network. For example, the HTTP port is 81. You should enter `http://192.168.1.42:81` in the address bar.*

14.3 Web WAN Access

➤ NAT Access

- ① Set the network of the NVR. Please refer to [13.1.1 TCP/IP Configuration](#) for details.
- ② Enable NAT and then set the NAT server address. Please refer to [13.1.8 NAT Configuration](#) for details.
- ③ Open a web browser on your computer, enter the NAT server address `www.autonat.com` in the address bar and then press enter to go to the interface as shown below (download and install the relative plugin according to the tip if you access the NVR through NAT for the first time).

Enter the serial number (click  on the tool bar at the bottom of the live preview interface to see the serial number of the NVR), user name (the user name of the NVR, admin by default) and password of the NVR, select the display language on the top right corner of the interface and then click "Login" to go to the web client interface.

➤ PPPoE Access

- ① Click Start→Settings→Network→PPPoE to go to the "PPPoE" interface. Check "Enable" in the "PPPoE settings" and then enter the username and password you get from your ISP. Click "Apply" to save the settings.
- ② Click Start→Settings→Network→Network Status to view the IP address of the NVR.
- ③ Open a web browser on your computer, enter the IP address of the NVR like <http://210.21.229.138> in the address bar and then press enter to go to the login interface. Enter the username and password of the NVR in the interface and then click "Login" to go to the live preview interface.

➤ Router Access

- ① Click Start→Settings→Network→TCP/IP to go to the "TCP/IP" interface. Set the IP address, subnet mask, gateway, preferred DNS and alternate DNS of the NVR.
- ② Set the HTTP port (it is suggested to modify the HTTP port because the default HTTP port 80 might be taken up) and enable UPnP function in both the NVR and the router. If the UPnP function is not available in the router, you need to forward the LAN IP address, HTTP port and server port of the NVR to the router. Port mapping settings may be different in different routers, so please refer to the user manual of the router for details.
- ③ Get the WAN IP address of the NVR from the router. Open a web browser on your computer, enter the WAN IP address plus HTTP port like <http://116.30.18.215:100> in the address bar and then press enter to go to the login interface. Enter the username and password of the NVR in the interface and then click "Login" to go to the live preview interface.

Note: If the WAN IP address is a dynamic IP address, it is necessary for you to use the domain name to access the NVR. Click Start Settings Network DDNS to set DDNS (see [13.1.4 DDNS Configuration](#) for details). By using DDNS function you can use the domain name plus HTTP port like `http://sunshine.dvrddns.com:100` to access the NVR via internet.

14.4 Web Remote Control

The supported browsers for remote access are IE8/9/10/11, Firefox, Opera and Chrome (available only for the versions lower than 45) in Windows system and Safari in MAC system. When you access the NVR through web client for the first time, you need to download and install the relative components for normal preview and playback. Please refer to the tips in the remote interfaces for details. The buttons and icons on the top right corner of the remote interface are introduced as follows.

admin: the current login username.

Logout: click it to log out and return to the login interface.

Modify Password: click it to change the password of the current login user. Enter the current password and then set a new password in the popup window. Click "OK" to save the new password.

Local Settings: click it to change the local settings. Set the snapshot number and click "Browse" to set the snapshot path and record path as shown below. Click "Apply" to save the settings.

Snapshots number	<input type="text" value="5"/>	<input type="button" value="v"/>
Save snapshots to	<input type="text" value="C:\Users\Administrator\Pictures"/>	<input type="button" value="Browse"/>
Save record files to	<input type="text" value="C:\Users\Administrator\Videos"/>	<input type="button" value="Browse"/>
<input type="button" value="Apply"/>		

14.4.1 Remote Preview

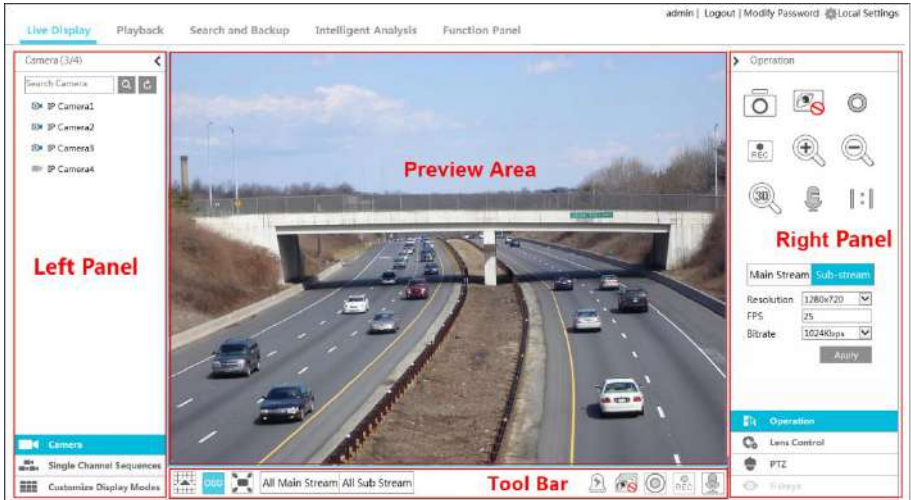

Click "Live Display" in the remote interface to go to the preview interface. The preview interface consists of the four areas marked in the following picture.





➤ Start Preview

Select a window in the preview area and then click one online camera on the left panel to preview the camera in the window. You can click  in the tool bar to preview all the cameras.

➤ Left Panel Introduction

Click  on the left panel to hide the panel and click  to show the panel. You can view all the added cameras and groups on the left panel.

● View Camera

Click  **Camera** to view the cameras. You can view the number of all the added cameras and the online cameras. For instance, the left number 3 in *Camera (3/4)* on the left panel stands for the number of online cameras; the right number 4 stands for the number of all the added cameras. Enter the camera name in the search box and then click  to search the camera. Click  to refresh the camera list.













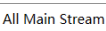

● View Group

Click  **Single Channel Sequences** to view the groups. The up side of the left panel displays all the groups and the down side displays all the cameras in the group.







● View Scheme



Click  **Customize Display Modes** to view the scheme. All schemes can be shown in the left panel. Double click the scheme name to invoke it quickly.

➤ Tool Bar Introduction











Button	Meaning
	Screen mode button.
	Click it to disable OSD. Click  to enable OSD.
	Click it to show full screen. Right click on the full screen to exit full screen.
 	Click "All Main Stream" or "All Sub Stream" to set the stream of all the cameras.
	Manual alarm button. Click it to pop up a window and then trigger and clear the alarm-out in the window manually.
	Click it to preview all the cameras.
	Click it to close all the preview cameras.
	Click it to start recording for all cameras to computer. Click  to stop recording.
	Click it to start recording for all cameras to the NVR. Click  to stop recording.
	Click it to enable talk with the NVR.

➤ Right Panel Introduction













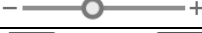
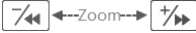

Click  on the right panel to show the panel and click  to hide the panel. Click  PTZ at the bottom of the panel to go to "PTZ" panel. Click  Operation to go to "Operation" panel. Click  Lens Control to go to "Lens Control" panel. Click  Fisheye to go to "Fisheye" panel.

Click one camera window in the preview area and then click  Main Stream to set the camera's live preview stream and record stream to main stream in manual record mode; click  Sub-stream to set the camera's live preview stream and record stream to sub stream. In sub stream tab, set the resolution, FPS and bitrate and then click "Apply" to save the settings.

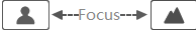
Operation panel introduction:

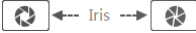

Button	Meaning
	Click it to snap.
	Click it to start record to computer
	Click it to start record to the NVR.
	Click it to zoom in the image of the camera and then drag the mouse on the camera image to view the hidden area.
	Click it to zoom out the image of the camera.
	Click it to start two-way talk.
	The 3D zoom in function is designed for P.T.Z. Click it and then drag the image to zoom in or zoom out the image; click the image on different areas to view the image of the dome omni-directionally.
	Click it to close the preview camera.
	Click it to display original size
	Click it to enable audio and then drag the slider bar to adjust the volume. You can listen to the camera audio by enabling audio.

PTZ panel introduction:

Button	Meaning
	Click  /  /  /  /  to rotate the dome; click  to stop rotating the dome.
	Drag the slider to adjust the rotating speed of dome.
	Click  /  to zoom in/out camera image.
	Click  /  to increase/ decrease the focal length.
	Click  /  to increase/decrease the iris of the dome.
	Click it to view the preset list and then click the button in the list to call the preset.
	Click it to view the cruise list and then click the corresponding buttons in the list to start or stop the cruise.

















14.4.2 Remote Playback

Click "Playback" in the remote interface to go to the playback interface.

- ① Check the record event types and cameras on the left panel. Set the record date on the calendar beside the time scale.
- ② Click  Search to search the record data and then click  Play or directly click the time scale to play the record.

The operation of the playback time scale is similar to that of the time scale in the main program of the NVR. Please refer to [8.2 Playback Interface Introduction](#) for details.



Introduction of playback control buttons:

Button	Meaning
	Stop button.
	Rewind button. Click it to play video backward.
	Play button. Click it to play video forward.
	Pause button.
	Deceleration button. Click it to decrease the playing speed.
	Acceleration button. Click it to increase the playing speed.
	Previous frame button. It works only when the forward playing is paused in single screen mode.
	Next frame button. It works only when the forward playing is paused in single screen mode.
 	Click  to step backward 30s and click  to step forward 30s.
	Backup start time button. Click the time scale and then click it to set the backup start time.
	Backup end time button. Click the time scale and then click it to set the backup end time.
	Backup button.
	Backup tasks button. Click it to view the backup status.
	Event list button. Click it to view the event record of manual/schedule/sensor/motion.

14.4.3 Remote Search and Backup

Click "Search and Backup" in the remote interface to go to the backup interface. You can back up the record by event or by time.

➤ By Event

Check the record type on the left side of the interface and then click  to set the start time and end time; check the cameras and then click  on the right side to search the record (the searched record data will be displayed in the list); check the record data in the list and then click "Backup" to backup the record.

➤ By Time







Click  to set the start time and end time on the left side of the interface; check the cameras and then click  on the right side to backup the record.

Image Management: Click "Image Management" to go to image management interface. The system will display all the captured images automatically in the list. Click  to delete the image. Click  to pop up the "Export" window. Click  to pop up the "View Image" window. Click  to export the image.

View Backup Status: Click "Backup Status" to view the backup status. Click "Pause" to pause; click "Resume" to continue the backup; click "Delete" to delete the task.

14.4.4 Intelligent Analysis

This function is only available for the model with VCA (video content analysis) functions. Click "Intelligent Analysis" in the remote interface to configure smart search, statistics, face database, face attendance and face check in. All of these settings are similar to that of the NVR. See the configurations of the NVR for details.

14.4.5 Remote Configuration

Click "Function Panel" in the remote interface and then configure the camera, record, alarm, disk, network, account and authority and system of the NVR remotely. All of these settings are similar to that of the NVR. See the configurations of the NVR for details.

Appendix A FAQ

Q1. Why can't I find the HDD?

- a. Please check the power and SATA data cables of the HDD to make sure they are well connected.
- b. For some NVRs with the 1U or small 1U case, the power of the adapter may be not enough for operating them. Please use the power adaptor supplied along with the NVR.
- c. Please make sure the HDDs are compatible with the NVR. See [Appendix C. Compatible Device List](#) for details.
- d. The HDD could have gone bad.

Q2. Why are there no images output in some or all of the camera windows?

- a. Please make sure the resolutions of the cameras are supported by the NVR.
- b. Please make sure the network cables of the IP camera and NVR are both connected properly and the network parameters are set correctly.
- c. Please make sure the network and the switch both work normally.

Q3. The screen has no output after booting the NVR normally.

- a. Please make sure the screen, HDMI or VGA cables are good and well connected.
- b. Please make sure the screen supports the resolution of 1280*1024, 1920*1080 or 3840*2160 (4K*2K). The NVR cannot self-adapt to the screen of which the resolution is lower than 1280*1024, and then the screen will remind you that the screen resolution is not supported by the NVR or just have no display. Please change a screen at 1280*1024, 1920*1080 or 3840*2160 resolution before booting the NVR.

Q4. Forget the passwords?

- a. The password for **admin** can be reset through "Edit Security Question" function. Click "Edit Security Question" in the login window and then enter the corresponding answer of the selected question in the popup window, the password for **admin** will be reset to **123456** by default. If you forget the answer of the question, this way will be invalid, please contact your dealer for help.
- b. The passwords of other users can be reset by **admin**, please refer to [10.1.2 Edit User](#) for details.

Q5. The NVR cannot add up to the maximum number of IP cameras?

Take the 16 CH NVR as an example. Some 16 CH NVR support a maximum of 120Mbps bandwidth input (please take the real device for standard). Refer to the picture below.

The remaining bandwidth should be larger than the bandwidth of the IP camera you want to add, or you would fail to add the IP camera. You should lower the added cameras' bitrate to release the bandwidth. It is recommended to add cameras by "Quickly Add" for batch adding.

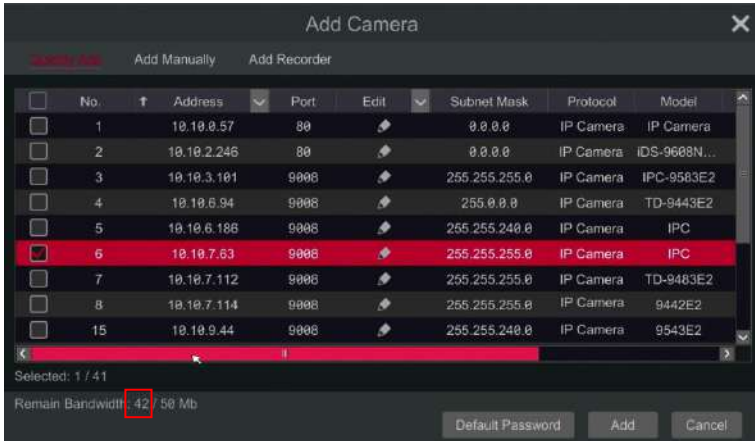

Q6. The IP camera which connects to the PoE port of the NVR cannot be displayed automatically in the camera list, why?

- Please check whether the resource of the PoE port is occupied by another IP camera that is added through network.
 - Take the 16 CH NVR with 8 PoE ports as an example. The resource distribution of the 16 CH IP cameras is shown in the picture below.

CH1	CH2	CH3	CH4	CH5	CH6	CH7	CH8	CH9	CH10	CH11	CH12	CH13	CH14	CH15	CH16
								POE-1	POE-2	POE-3	POE-4	POE-5	POE-6	POE-7	POE-8

When you add IP cameras through network, the IP cameras will occupy the resource from CH1, CH2, CH3, CH4... by the adding sequence; if you directly connect the IP cameras to the PoE ports of the NVR, the IP cameras will occupy the resource from CH9 to CH16 according to the number of the PoE port each IP camera is connecting to. Supposing that 12 CH IP cameras have been added to the NVR through network and no IP camera has been directly connected to the PoE port. The 12 CH IP cameras occupy the 8 network resources from CH1 to CH8 and 4 PoE resources from CH9 to CH12 which are supposed to be occupied by connecting the IP cameras directly. In this situation, if you directly connect one IP camera to PoE5, PoE6, PoE7 or PoE8, the IP camera will be displayed in the camera list automatically; if you connect it to PoE1, PoE2, PoE3 or PoE4, it won't be displayed in the camera list by showing resource conflict; if you just need to connect it to PoE1, PoE2, PoE3 or PoE4, you should first delete the IP camera which occupies the PoE port resource and then reconnect it to the PoE port.

- Take the 8 CH NVR with 8 PoE ports as another example. The resource distribution of the 8 CH IP cameras is shown in the picture below and the adding rules of the IP cameras are similar to the rules mentioned in the above. Please refer to the above for details.

CH1	CH2	CH3	CH4	CH5	CH6	CH7	CH8
POE-1	POE-2	POE-3	POE-4	POE-5	POE-6	POE-7	POE-8

- b. Please make sure that the internal ethernet port and the IP camera which directly connects to the PoE port through ONVIF protocol are in the same network segment.

The internal ethernet port and the IP camera which directly connects to the PoE port through ONVIF protocol should be in the same network segment, or you will fail to add the IP camera. Log in the IP camera's web client and then enable DHCP (obtain an IP address automatically); or manually change the IP address of the IP camera to make it in the same network segment with the internal ethernet port.

- c. Check whether the number of the added IP camera is the maximum.

If the number of the added IP camera is the maximum, the system will show you the message that the IP camera number is beyond the maximum when you directly connect another IP camera to the available PoE port and thus you will fail to add the IP camera.

Q7. The IP camera which directly connects to the PoE port of the NVR through ONVIF protocol is shown in the camera list, but there is no image output, why?

Please make sure the username and password of the IP camera are correct. The IP camera's username and password can be modified through the two ways mentioned as below.

- ① Click "Edit Camera" in the Camera module of the setup panel to go to the interface as shown below. Click  to modify the username and password of the IP camera (enter the correct username and password of the IP camera in the popup window and then click "OK").

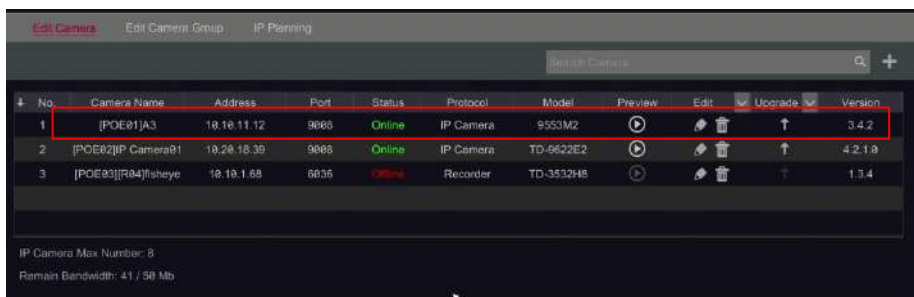

- ② Go to the live preview interface and then click  in the preview window of the IP camera to edit the IP camera's username and password.

Q8. The system cannot record, why?

- a. Make sure the HDD was formatted prior to use.
- b. The record schedule has not been set in manual record mode. Please refer to [7.3.2 Record Schedule Configuration](#) for details.
- c. Maybe HDD is full and thus the NVR is not able to record. Check HDD information from Disk Management and if required, please enable the recycle function (please see [7.1.2 Advanced Configuration](#) for details).
- d. There is no disk but cameras in the disk group, so please add at least one disk to the group. Refer to [7.5.1 Storage Mode Configuration](#) for details.
- e. The HDD could have gone bad. Please change another one.

Q9. Fail to access the NVR remotely through IE.

- a. Please make sure the IE version is IE8 or above.
- b. Please check whether the PC has enabled the firewall or installed the antivirus software. Please try to access the NVR again after you disable the firewall and stop the antivirus software.
- c. Allow & block list may have been set in Account and Authority setting. The PC of which the IP address is in the black list or out of the white list cannot access the NVR remotely.

Q10. ActiveX control cannot be downloaded. How can I do?

- a. IE browser blocks ActiveX control. Please do setup as per the steps mentioned below.
 - ① Open IE browser. Click  → Internet Options.

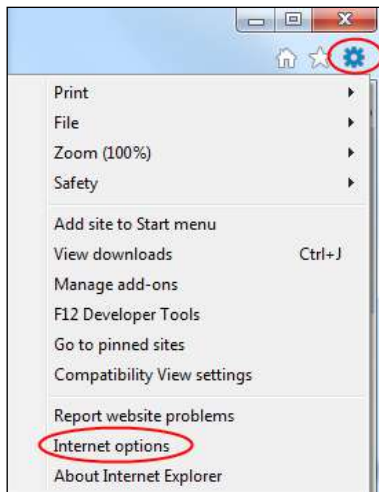

- ② Select Security → Custom Level. Refer to Fig 10-1.
- ③ Enable all the sub options under "ActiveX controls and plug-ins". Refer to Fig 10-2.
- ④ Then click "OK" to finish setup.

- b. Other plug-ins or anti-virus may block ActiveX. Please disable or do the required settings.

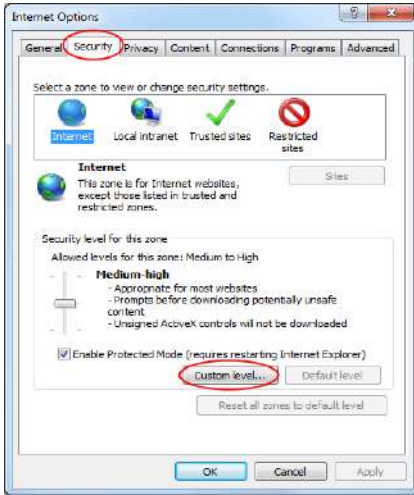

Fig 10-1

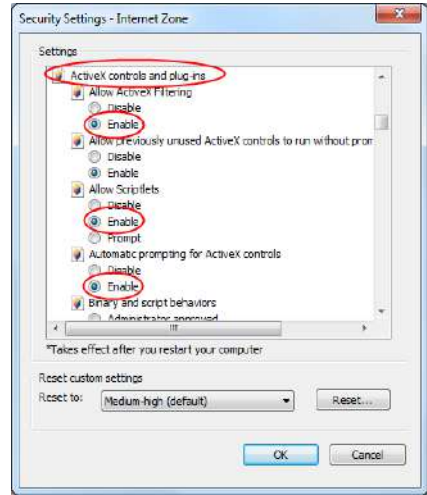



Fig 10-2

Q11. How to play the backup file?

a. Record backed up by NVR: insert the USB device in which the record backup files is saved to the USB interface of the PC and then open the USB device path. The record can be backed up in the private format and AVI format by NVR.

- If you select the private format when backing up record by NVR, a RPAS compression package will be backed up to the USB device automatically along with the record data. Uncompress the "RPAS.zip" and then click "RPAS.exe" to set up RPAS. After the setup is completed, open RPAS player and then click "Open Folder" in the middle of the interface to select the record data. Refer to Fig 11-1.

Select camera in the resource tree on the left side of the interface to play the camera record. Click  on the tool bar under the camera image to enable audio. Refer to Fig 11-2.

Note: The record will not have audio output if you disable the audio when recording by NVR. Please see 7.1.1 Mode Configuration and 7.2 Encode Parameters Setting for details.

- If you select the AVI format when backing up record by NVR, the record backup data can be played by the video player which supports this format.
- b. Record backed up through web. The record can only be backed up with AVI format through web. The record can be backed up to PC and played by the video player which supports this format.

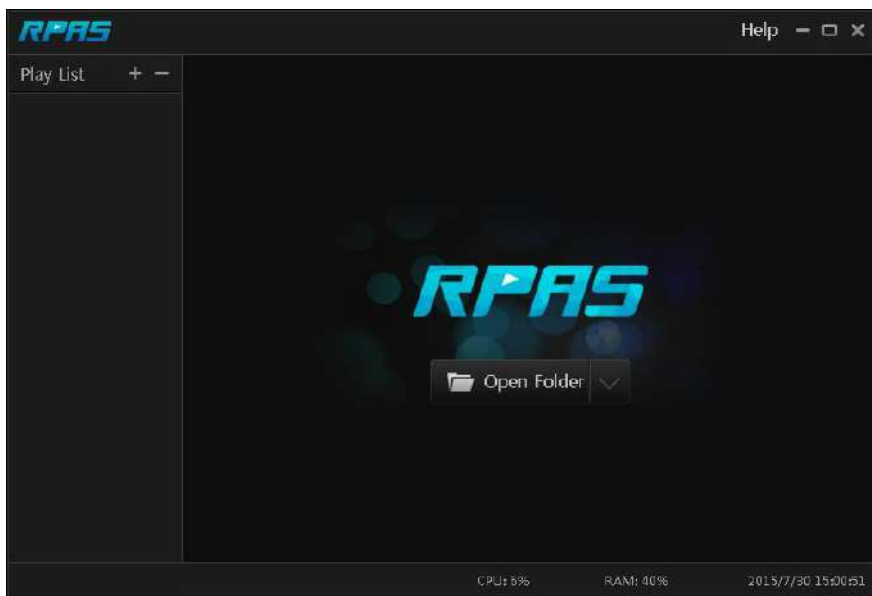

Fig 11-1

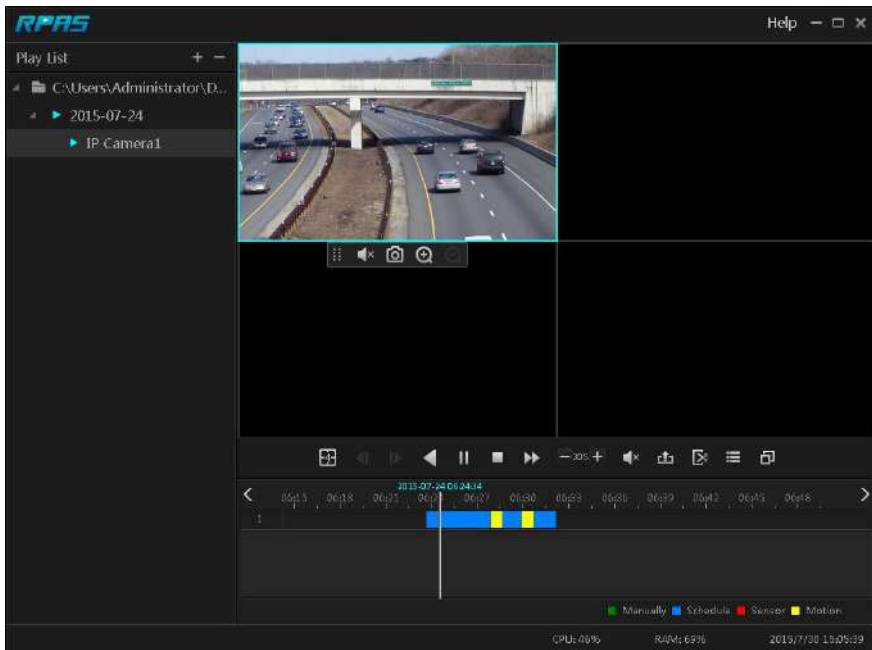

Fig 11-2

Appendix B Calculate Recording Capacity

Appendix B Calculate Recording Capacity

The recording capacity is mainly up to the record resolution, record stream and bitrate. Different image quality parameters decide different disk capacity occupation in equal times. The bigger the record resolution, record stream and record bitrate is, the more disk capacity is taken up in equal times. The calculation format of recording capacity is shown as below.

Recording Capacity(MB) = Bitrate(Kbps) ÷ 1024 ÷ 8 × 3600 × Recording hours per day × Record Storage Days × channel numbers

3600 means record for an hour(1TB=1024GB, 1GB=1024MB, 1MB=1024KB, 1Byte=8bit).

Record Bitrate (Kbps)	Used Space (MB/H)	Used Space (MB/D)
10240	4500	108000
8192	3600	86400
6144	2700	64800
4096	1800	43200
3072	1350	32400
2048	900	21600
1024	450	10800
768	337.5	8100
512	225	5400
384	168.75	4050
256	112.5	2700

The table below shows the recording capacity requirements for record storage in 30 days.

Record Bitrate (Kbps)	Recording Capacity(TB)					
	1CH	4CH	8CH	16CH	32CH	64CH
10240	3.09	12.36	24.72	49.44	98.88	197.76
8192	2.48	9.89	19.78	39.56	79.11	158.21
6144	1.86	7.42	14.84	29.67	59.33	118.66
4096	1.24	4.95	9.89	19.78	39.56	79.11
3072	0.93	3.71	7.42	14.84	29.67	59.33
2048	0.62	2.48	4.95	9.89	19.78	39.56
1024	0.31	1.24	2.48	4.95	9.89	19.78
768	0.24	0.93	1.86	3.71	7.42	14.84
512	0.16	0.62	1.24	2.48	4.95	9.89
384	0.12	0.47	0.93	1.86	3.71	7.42
256	0.08	0.31	0.62	1.24	2.48	4.95

For instance, there is a 32CH NVR recording 24 hours per day and the record stores for 30 days. The NVR adopts dual stream recording. The main stream is 4096Kbps and the sub stream is 1024Kbps, then the total recording capacity is 49.45TB (39.56TB + 9.89TB).

Considering the format loss of the disk is about 10%, the required disk capacity will be 55TB ($49.45\text{TB} \div (1-10\%)$).

Appendix C Compatible Device List

Appendix C Compatible Device List

Compatible HDD list

Brand and Series		Capacity
Seagate	Barracuda Series	500GB /1TB /2TB /3TB
	SV35 Series (recommended)	1TB /2TB /3TB
	Surveillance HDD Series (recommended)	1TB /2TB /3TB /4TB /6TB
Western Digital	Blue Series	500GB /1TB
	Green Series	2TB /3TB /4TB
	Purple Series (recommended)	1TB /2TB /3TB /4TB /6TB

Compatible HDD list

Brand	Capacity
SSK	2GB
Netac	4GB
Kingston	2GB/8GB/16GB/32GB
Aigo	2GB
Smatter vider	1GB
SanDisk	4GB/8GB/16GB/32GB

Appendix D Communication Port List

Appendix D Communication Port List

Port	Protocol(TCP/UDP)	Descriptions
80	TCP	Description: HTTP communication port. It is opened by default and used to access the WEB client. Authentication: Username and password Encryption: NO
443	TCP	Description: HTTPS communication port. It is opened by default and used to access the WEB client. Authentication: Username and password Encryption: TLS
554	TCP	Description: RTSP communication port. It is closed by default. After enabling RTSP function, this port will be opened and used to transfer audio and video stream. Authentication: Username and password (Digest) Encryption: NO
6036	TCP	Description: Private communication port. It is opened by default and used to transfer audio and video stream. Authentication: Username and password (Digest) Encryption: AES
9036	TCP	Description: This port is opened by default which is mainly used to receive the information sent by the POS terminal or printer. The information will be overlaid on the image of the IPC you have configured in previewing or recording mode. Authentication: NO Encryption: NO
41952	TCP	Description: This port is opened by default which is mainly used to receive the request sent by other UPnP devices and communicate with other UPnP devices. Authentication: NO Encryption: NO
41953	TCP	Description: This port is closed by default. After the UPnP function is enabled, this port is enabled too. It is mainly used to receive the request sent by other UPnP devices and communicate with other UPnP devices. Authentication: NO Encryption: NO
1900	UDP	Description: This port is opened by default which is used to enable, find and run SSDP. Additionally, it is also used to listen to and receive the multicast packets from other online UPnP devices. Authentication: NO Encryption: NO

Appendix E Personal Data Collection Description

Appendix E Personal Data Collection Description

There are five functions concerning the personal data collection under the network modules of the device, including PPPoE, DDNS, E-mail, 802.1x and FTP. In the device, these functions are used by the client-end of the device to communicate with the server of the customer's company (or service supplier). As the client-end, our device needs to keep the authentication credentials (username and password) used to connect the server. These credentials can be configured through the Web client of the device and then sent to the device. The process of the data transmission and storage are as follows.

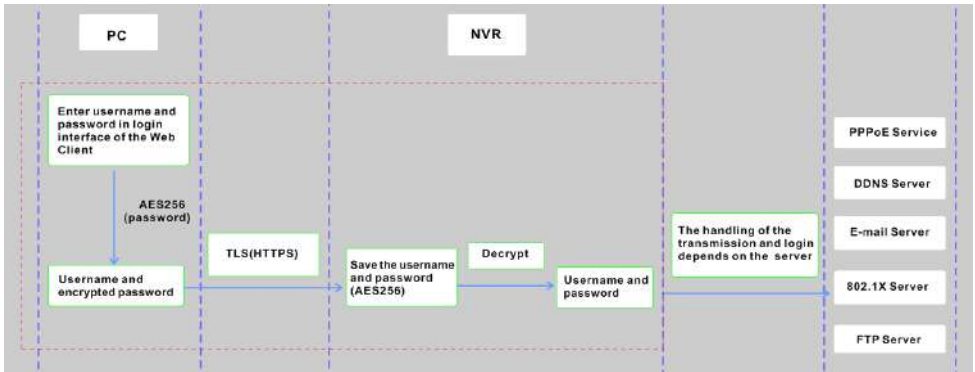

Function	Personal Data Type	Transmission Type	Storage Type	Authentication
PPPoE	Username, Password	TLS+AES256(password)	Password : AES256	Username/Password
DDNS	Username, Password	TLS+AES256(password)	Password : AES256	Username/Password
E-mail	Username, Password, E-mail address	TLS+AES256(password)	Password : AES256 The E-mail address will be desensitized before it is displayed on the page.	Username/Password
802.1x	Username, Password	TLS+AES256(password)	Password : AES256	Username/Password
FTP	Username, Password	TLS+AES256(password)	Password : AES256	Username/Password

Statement:

Except for service authentication when communicating with the server, we will never share these personal data stored on the device to the third-party or use them by ourselves without the client's authorization.

The log will record the operator's operation steps and change records, and will not contain any information about the collected personal data.

Appendix F Default Account List

Appendix F Default Account List

Username	Default Password	Descriptions
admin	NO	<p>Purpose : log onto the device and its clients</p> <p>Description : When you log in for the first time, a wizard will be displayed. You must set the password, or you cannot access the device.</p> 
root	NO	<p>Purpose : Test via serial port</p> <p>Description : The default password of "root" is null. It doesn't mean you can log in the device without password. You must set the password of "admin" in the above-mentioned interface first. Then you can log in by using "root".</p>

Statement:

Remote testing/debugging doesn't support (Telnet/SSH unavailable) for the device. When an error occurs, the customer needs to send the device back to our company and tell us the password of "admin" used to log in the device and web client. Then the corresponding technician of our company will log in the serial port to find the problem. Without the customer's identity verification information and the customer's authentication, we cannot log in and do not have permission to log into the device.

Appendix G Command List

Appendix G Command List

Command Type	Function	Command Contents
Operating Command	Hilinux Operating System Command	add-shell addgroup adduser arp ash awk basename blkid blockdev btools busybox cat chat chmod chpst cmp cp cut date dd delgroup deluser depmod devmem df diff dmesg dnsdomainname dos2unix du echo ed egrep eject env envdir envuidgid expr fbset fgrep find free fsck.vfat fsync getty grep groups halt head hexdump hiddrs himc himd himd.l himm hostname hwclock i2c_read i2c_write id ifconfig ifstat init insmod iostat ip ipaddr iplink iproute iprule iptables iptunnel kill killall killall5 ln login logname ls lsmode lsmod lsosf lspci lsusb lzcat lzma md5sum mdev mkdir mkfifo mknod modinfo modprobe mount mountpoint mv netstat nice passwd pidof ping ping6 pmap poweroff pppd pppoe printf ps pstree pwd readlink reboot remove-shell renice restoreCFG_N9000.sh rm rmdir rmmode route sed setsid setuidgid sh shutdown_os.sh sleep softlimit stat stty sync tail tar test time top touch tty ubiattach ubidetach udevadm udevd udhpcd umount uname unix2dos unlzma uptime usleep vconfig vi watch wc xargs yes

.AVYCON[®]



.AVYCON[®]

Copyright © AVYCON. All rights reserved. Specifications and pricing are subject to change without notice.

phone: 949-752-7606

email: info@avycon.com

social: [@avycon_aivo](https://www.instagram.com/avycon_aivo)

website: avycon.com