

Strikelt[®]

Strikelt2

Panic Device Power Controller

Installation Guide



Rev. 050919

More than just power.[™]

Installing Company: _____ Service Rep. Name: _____

Address: _____ Phone #: _____

Table of Contents:

Overview	pg. 3
Specifications	pg. 3
Installation Instructions	pg. 3
LED Diagnostics	pg. 4
Maintenance	pg. 4
Terminal Identification:	pg. 4
Wiring Distance Table	pg. 4
Typical Application Diagram	pg. 5
Enclosure Drawing and Dimensions	pg. 8

Overview:

Altronix Strikelt2 operates one (1) 24VDC panic hardware device. It is designed to handle the high current surge panic hardware locking devices demand. In addition, an auxiliary power output provides power for accessory devices such as card readers, keypads, REX PIRs, electronic timers, relays, etc.

Specifications:

Agency Approval:

- **UL 294*** Access Control System Units.
- **CSA Standard C22.2 No.205-M1983** Signal Equipment.
- **CSFM** California State Fire Marshal Approved.

Input:

- 115VAC, 60Hz, 7A.
- One (1) N/O trigger input.

Output:

- One (1) 23.2-24VDC lock output rated up to 16A for 300ms, 0.5A continuous hold current.**
- One (1) 23.2-24VDC filtered regulated auxiliary output rated @ 0.5A continuous supply current**

Battery Backup:

- Battery leads included.
- Built-in charger for sealed lead acid or gel type batteries.
- Automatic switch over to stand-by battery when AC fails.
- Maximum charge current 0.3A.
- When 4AH batteries are used, battery capacity for emergency stand-by is at least a 1/2 hour.

Visual Indicators:

- Green AC Power LED indicates 115VAC present.
- Red LED indicates presence of 24VDC.

Mechanical:

- Enclosure Dimensions (H x W x D approx.): 8.5" x 7.5" x 3.5" (215.9mm x 190.5mm x 88.9mm)
- Enclosure accommodates up to two (2) 12VDC/4AH batteries.

* **Access Control Performance Levels:** Destructive Attack - I; Endurance - IV; Line Security - I; Stand-by Power - II.

** **Note:** Total combined current for the outputs may not exceed 1A.

Installation Instructions:

Wiring methods shall be in accordance with the National Electrical Code/NFPA 70/NFPA 72/ANSI, and with all local codes and authorities having jurisdiction. Product is intended for indoor use only.

1. Mount unit in the desired location within protected premises (Maximum Wiring Distance Table, pg. 5). Mark and predrill holes in the wall to line up with the top two keyholes in the enclosure. Install two upper fasteners and screws in the wall with the screw heads protruding. Place the enclosure's upper keyholes over the two upper screws; level and secure. Mark the position of the lower two holes. Remove the enclosure. Drill the lower holes and install the two fasteners. Place the enclosure's upper keyholes over the two upper screws. Install the two lower screws and make sure to tighten all screws (*Enclosure Dimensions, pg. 8*). Secure cabinet to earth ground.
2. Connect AC power (115VAC, 60Hz) to the terminals marked [L, G, N] (*Fig. 1, pg. 5 & Fig. 2, pg. 6*). The AC LED (Green) will illuminate, indicating power is present. This light can be seen through the LED lens on the door of the enclosure.

Keep power-limited wiring separate from non power-limited wiring (115VAC, 60Hz Input, Battery Wires). Minimum 0.25" spacing must be provided (*Fig. 2, pg. 6*).

CAUTION: Do not touch exposed metal parts.

Shut branch circuit power before installing or servicing equipment.

There are no user serviceable parts inside. Refer installation and servicing to qualified service personnel.

3. Measure output voltage at the terminals marked [- AUX +] and [- OUT +] before connecting devices (*Fig. 1, pg. 5 & Fig. 2b, pg. 6*). This helps avoiding potential damage.
Note: Voltage will be present on the output when the unit is not triggered and electric panic hardware is not connected.
4. Connect 24VDC panic hardware device to the terminals marked [- OUT +] (*Fig. 1, pg. 5 & Figs. 2 & 2b, pg. 6*). Be sure to observe polarity. Voltage should dissipate across output terminals when load is properly connected.
5. Connect Normally Open [NO] Dry Contacts from actuating devices such as an Access Control Panel, REX PIR, Keypad, etc. to the terminals marked [GND, NO] (*Fig. 1, pg. 5 & Fig. 2b, pg. 6*).
6. Connect auxiliary devices to be powered (Keypads, REX motion detectors, electronic timers, external relays) to the auxiliary power output terminals marked [- AUX +] (*Fig. 1, pg. 5 & Fig. 2b, pg. 6*).

7. When using stand-by batteries, they must be lead acid or gel type. 4AH batteries will provide a 1/2 hour of backup time. Connect two (2) 12VDC batteries wired in series to the terminals marked [- BAT +].
For Access Control applications batteries are optional. When batteries are not used, a loss of AC will result in the loss of output voltage (Fig. 2b, pg. 6).
8. Mount UL Listed tamper switch (Altronix model TS112 or equivalent) at the top of the enclosure. Slide the tamper switch bracket onto the edge of the enclosure approximately 2" from the right side (Fig. 2a, pg. 6).
Connect tamper switch wiring to the Access Control Panel input or the appropriate UL Listed reporting device. To activate alarm signal open the door of the enclosure.
9. Upon completion of the wiring secure enclosure door with screws or cam lock.

LED Diagnostics:

LED	LED Status	Panic Device Power Controller Status
AC Power Green	On	Normal operating condition.
	Off	Loss of AC.
Red	On	24VDC present on the output (unit is triggered).
	Off	Loss of 24VDC on the output (unit is not triggered).

Maintenance:

Unit should be tested at least once a year for the proper operation as follows:

Output Voltage Test: Under normal load conditions the DC output voltage should be checked for proper voltage level.
Battery Test: Under normal load conditions check that the battery is fully charged, check specified voltage both at battery terminal and at the board terminals marked [- BAT +] to ensure that there is no break in the battery connection wires.

Note: Maximum charging current under discharge is 300mA.

Note: Expected battery life is 5 years; however, it is recommended changing batteries in 4 years or less if needed.

Caution: For continuous protection against risk of electric shock and fire hazard, replace input fuse with the same type and rating 6.3A/250V. Do not expose to rain or moisture; indoor use only.

Terminal Identification:

Terminal Legend	Function/Description
- AUX +	23.2-24VDC Auxiliary Output @ 0.5A.
- BAT +	23.2-24VDC Stand-by Battery Connection (Two (2) 12VDC batteries wired in series).
- OUT +	Connect 24VDC Panic Hardware Device, up to 16A for 300 ms., 0.5A on hold.
GND / NO	Normally Open [NO] trigger input controls output. A maintained contact closure will extend the unlock period.

Wiring Distance Table:

InRush Current	Wire Gauge	Electric Butt or Pivot Max distance from Power Supply to frame side of opening	EPT Max distance from Power Supply to frame side of opening
8A	14 AWG Stranded	75 ft.	100 ft.
8A	12 AWG Stranded	175 ft.	200 ft.
12A	14 AWG Stranded	60 ft.	75 ft.
12A	12 AWG Stranded	80 ft.	100 ft.
16A	14 AWG Stranded	40 ft.	75 ft.
16A	12 AWG Stranded	60 ft.	80 ft.

Typical Application Diagram:

Fig. 1

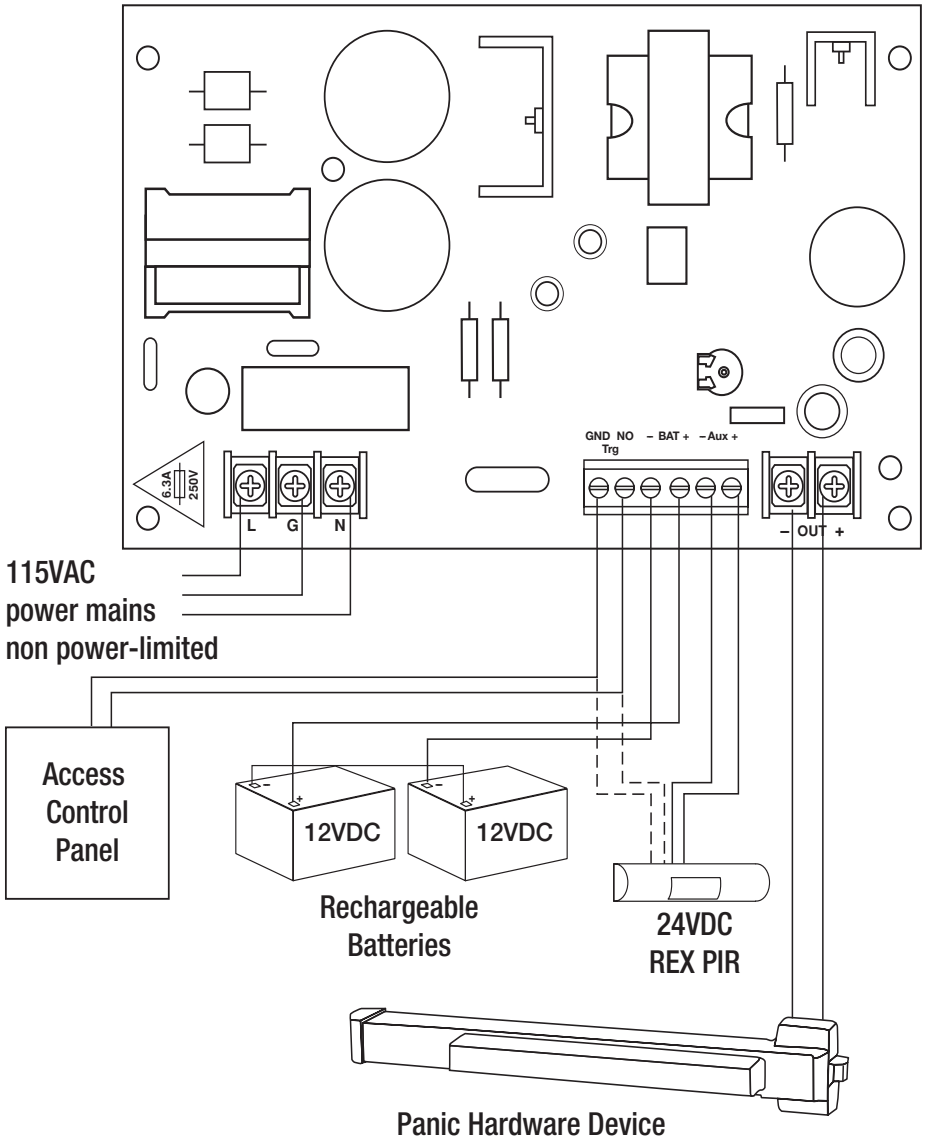

Fig. 2

CAUTION: De-energize unit prior to servicing.

For continued protection against risk of electric shock and fire hazard replace main fuse with the same type and rating 6.3A/250V.

Do not expose to rain or moisture.

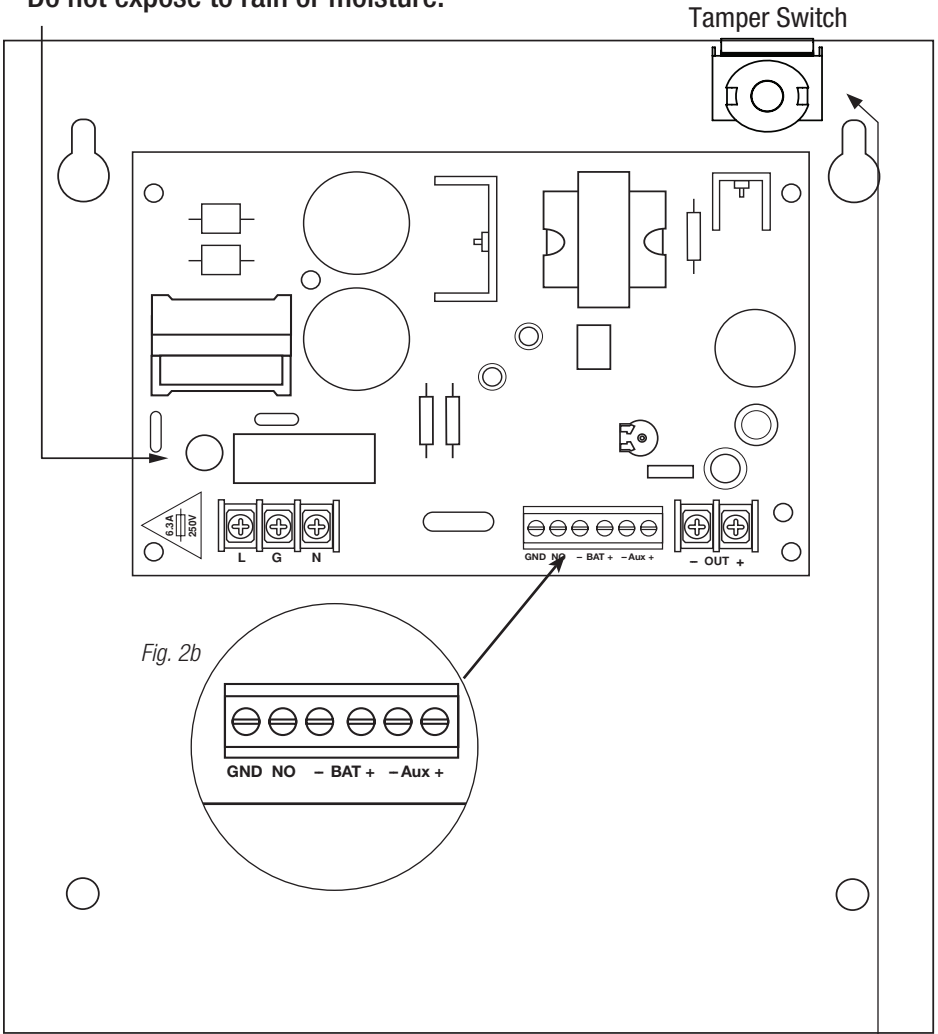

Fig. 2b

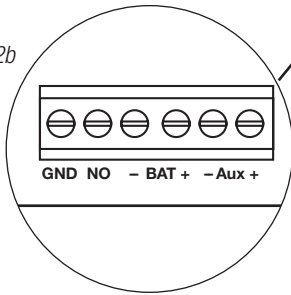
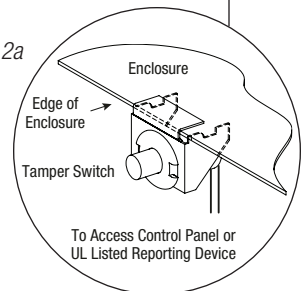

Fig. 2a



Notes:

Enclosure Dimensions (H x W x D approximate):

8.5" x 7.5" x 3.5" (215.9mm x 190.5mm x 88.9mm)

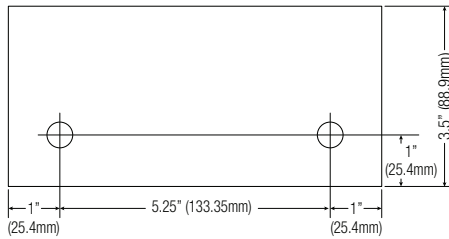
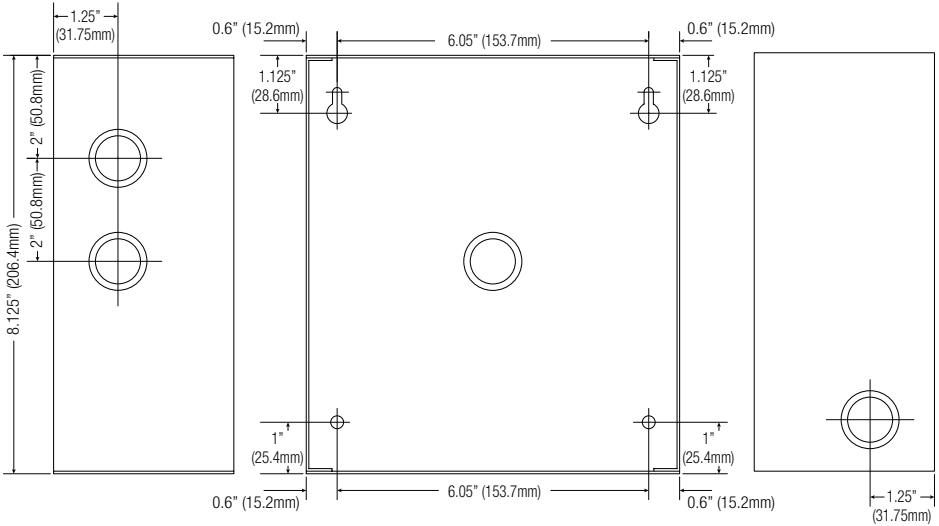
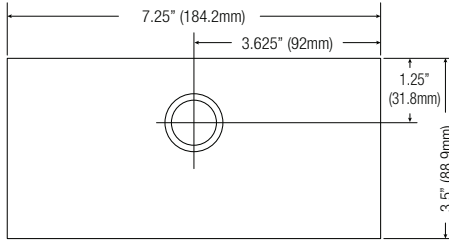

Altronix is not responsible for any typographical errors.

140 58th Street, Brooklyn, New York 11220 USA | phone: 718-567-8181 | fax: 718-567-9056
website: www.altronix.com | e-mail: info@altronix.com | Lifetime Warranty
IIStrikelt2 K02U

