

Video • Data • Power



## ***Passive UTP Transceiver Hub with Integral Camera Power***

### ***Installation Guide***

#### ***Models Include:***

##### ***HubWay8CD***

- UL Listed eight (8) Channel Passive UTP Transceiver Hub with Integral Camera Power

##### ***HubWay82CD***

- UL Listed eight (8) Channel Passive UTP Transceiver Hub with Integral Camera Power
- Includes eight (8) UL Listed Accessory HubWayAv Video Balun/Combiners

##### ***HubWay83CD***

- UL Listed eight (8) Channel Passive UTP Transceiver Hub with Integral Camera Power
- Includes eight (8) UL Listed Accessory HubWayDv Video Balun/Combiners

##### ***HubWay16CD***

- UL Listed sixteen (16) Channel Passive UTP Transceiver Hub with Integral Camera Power

##### ***HubWay162CD***

- UL Listed sixteen (16) Channel Passive UTP Transceiver Hub with Integral Camera Power
- Includes sixteen (16) UL Listed Accessory HubWayAv Video Balun/Combiners

##### ***HubWay163CD***

- UL Listed sixteen (16) Channel Passive UTP Transceiver Hub with Integral Camera Power
- Includes sixteen (16) UL Listed Accessory HubWayDv Video Balun/Combiners



## Overview:

Altronix HubWay8CD/16CD Passive UTP Transceiver Hub with Integral Camera Power transmits UTP video, RS422/RS485 data and power over a single CAT-5 or higher structured cable. Unit provides 8 or 16 camera channels in a space saving 1U EIA 19" rack mount chassis which may be rack, wall or shelf mounted. Video transmission range is up to 750 ft. max. per channel. Units are compatible with AC and/or DC fixed or PTZ cameras when utilizing Altronix HubWayAv, HubWayAv2, HubWayDv or HubWayDvi Video Balun/Combiners. In addition, the unit features individually selectable 24VAC or 28VAC PTC protected outputs with surge suppression. An optional HubSat4D Passive UTP Transceiver Hub with Integral Camera Power can be used as an accessory module to transmit video from up to 4 cameras over a single CAT-5 or higher structured cable back to the HubWay8CD/16CD. In addition, the HubSat4D provides power to these cameras locally to eliminate the possibility of voltage drop associated with long cable runs.

## HubWay Specifications:

### HubWay8CD/82CD/83CD

#### Input:

- 115VAC, 60Hz, 1.5A.

#### Video:

- Eight (8) channels of video over twisted pair up to a distance of 750 ft. per channel.
- Eight (8) 75 Ohm video outputs.

#### Power:

- Unit provides up to 1A max. per channel not to exceed a total of 5A (150VA) maximum current.

### HubWay16CD/162CD/163CD

#### Input:

- 115VAC, 60Hz, 3A.

#### Video:

- Sixteen (16) channels of video over twisted pair up to a distance of 750 ft. per channel.
- Sixteen (16) 75 Ohm video outputs.

#### Power:

- Unit provides up to 1A max. per channel not to exceed a total of 10A (300VA) maximum current.

## Common Specifications:

### Agency Listings:

- UL Listed for Commercial CCTV Equipment (UL 2044).
- cUL Listed - CSA Standard C22.2 No.1-04, Audio, Video and Similar Equipment.

### Data:

- RS422/RS485 data inputs.

### Power:

- Individually selectable 24VAC or 28VAC power outputs with OFF position.
- PTC protected outputs are rated @ 1A per channel.
- Surge suppression.

### Visual Indicators:

- AC input power indicator.

### Features:

- Illuminated master power disconnect circuit breaker with manual reset.
- IEC 320 - 3-wire grounded line cord (detachable).
- Unit can be rack, wall or shelf mounted.
- 1U rack mount chassis for use in standard EIA 19" rack.

### Accessories:

- Video Balun/Combiners:
  - HubWayAv: for use with 24VAC cameras.
  - HubWayAv2: for use with 24VAC cameras.
  - HubWayDv: for use with 12VDC cameras.
  - HubWayDvi: for use with non-isolated 12VDC cameras.
- Optional HubSat4D allows transmission of up to four (4) video signals over a single CAT-5 or higher structured cable.

## Additional Models:

### HubWay82CD

- HubWay8CD with eight (8) UL Listed Accessory HubWayAv Video Balun/Combiners for 24VAC Cameras.

### HubWay83CD

- HubWay8CD with eight (8) UL Listed Accessory HubWayDv Video Balun/Combiners for 12VDC Cameras.

### HubWay162CD

- HubWay16CD with sixteen (16) UL Listed Accessory HubWayAv Video Balun/Combiners for 24VAC Cameras.

### HubWay163CD

- HubWay16CD with sixteen (16) UL Listed Accessory HubWayDv Video Balun/Combiners for 12VDC Cameras.

**WARNING: To reduce the risk of fire or electric shock do not expose the unit to rain or moisture. This installation should be made by qualified service personnel and should conform to all local codes.**

## Installation Instructions:

1. Attach mounting brackets to HubWay unit for rack or wall mount installation (Figs. 6-7, pg. 8). Affix rubber pads to HubWay for shelf installation (Fig. 8, pg. 8).
2. Secure the unit in a rack, mount unit to a wall or place unit on a shelf as desired (unit should be spaced at least 3" from any video monitors).
3. Set illuminated master power disconnect circuit breaker to the (OFF) position (Fig. 5, pg. 7).
4. Plug the grounded AC line cord (included) into the IEC 320 connector of the HubWay8CD/HubWay16CD unit (Fig. 1g, pg. 4). Insert the plug end of the line cord into a grounded AC receptacle.
5. Set voltage output selector switch of each camera channel for 24VAC or 28VAC (Fig. 1d, pg. 4).
6. Connect the BNC video outputs for HubWay8CD/16CD Channels 1 - 8 (Channels 1-16) to the corresponding video inputs on the head end equipment (DVR) (Fig. 1f, pg. 4).
7. Connect the RS422/RS485 output of the head end equipment (DVR) to the one (1) or both data input terminal blocks of the HubWay8CD or HubWay16CD unit (polarity must be observed) (Fig. 1e, pg. 4).

**Note:** The Data input terminals of the HubWay8CD or HubWay16CD must be wired in parallel for proper operation. When using fixed cameras disregard this step.

8. Connect Video Balun/Combiner at camera 1 to the HubWay8CD or HubWay16CD unit utilizing CAT-5 or higher structured cable. Plug the RJ45 connector at one end of the structured cable into the RJ45 jack marked [Channel 1] of the HubWay8CD/16CD (Fig. 1a, pg. 4). Plug the RJ45 connector at the opposite end of the structured cable into the RJ45 jack of the Video Balun/Combiner located at camera 1.
  - For 24VAC cameras use Altronix model HubWayAv/HubWayAv2 Video Balun/Combiner (Figs. 2a, 2b, 2e, pg. 5).
  - For 12VDC cameras use Altronix model HubWayDv Video Balun/Combiner (Figs. 2c, 2d, pg. 5).
  - For non-isolated 12VDC cameras use Altronix model HubWayDvi Video Balun/Combiner (Figs. 2c, 2d, pg. 5).

Repeat steps 6-9 for each additional camera (Channels 2-8 or Channels 2-16).

**Note:** When a particular camera exceeds the maximum distance for power transmission, a local external power source is required. Optionally, an Altronix HubSat4D Passive UTP Transceiver Hub with Integral Camera Power may be utilized (Fig. 4a, pg. 6). The combined total cable distance must not exceed 750 ft. for video transmission between the HubWay8/16 and each camera routed through the HubSat4D.

9. Set illuminated master power disconnect circuit breaker to the RESET (ON) position (Fig. 5, pg. 7) and measure the output voltage at the power output of each Video Balun/Combiner (Figs. 2b, 2d, pg. 5) before powering each camera to ensure proper operation and avoid possible damage.
  - HubWayAv/HubWayAv2 - Terminals marked [AC POWER] (Figs. 2a, 2b, 2e, pg. 5).
  - HubWayDv/HubWayDvi - Terminals marked [- 12VDC +] (Figs. 2c, 2d, pg. 5).
10. Set illuminated master power disconnect circuit breaker to the (OFF) position to make the final connections (Fig. 5, pg. 7).
11. Connect the power outputs of the HubWayAv, HubWayAv2, HubWayDv or HubWayDvi Video Balun/Combiners to the power inputs of the cameras (Figs. 2a-2e, pg. 5). Polarity must be observed.
12. Connect the terminals marked [+ DATA -] of the HubWayAv or HubWayDv Video Balun/Combiners to the data terminals of the cameras for PTZ control (Figs. 2a-2e, pg. 5). Polarity must be observed. When using fixed cameras disregard this step.
13. Connect the BNC connectors of the HubWayAv, HubWayAv2, HubWayDv or HubWayDvi Video Balun/Combiners to the BNC video outputs of the cameras (Figs. 2a-2e, pg. 5).
14. Upon completion of the wiring set illuminated master power disconnect circuit breaker to the RESET (ON) position (Fig. 5, pg. 7).
15. The power LEDs (Red) located on the front of the HubWay8CD/16CD will illuminate when AC power is present (Fig. 1c, pg. 4).

**Note:** If any of these LEDs are not illuminated, either a voltage output selector switch is in the OFF position or the PTC is tripped for that channel.

To reset the PTC:

1. Set the voltage output selector switch for that corresponding channel to the OFF position. Switch must remain in the OFF position for approximately 2 minutes in order for the PTC to reset.
  2. Eliminate the trouble condition (short circuit or overload).
  3. Set the voltage output selector switch for 24VAC or 28VAC (Fig. 1d, pg. 4).
16. AC LEDs (Green) of the HubWayAv or DC LEDs (Red) of the HubWayDv/HubWayDvi Video Balun/Combiners will illuminate indicating power is present at the cameras (Fig. 2b, 2d, pg. 5).

Fig. 1

**1e - Data:** Removable terminal blocks for RS422/RS485 input from head end equipment (DVR) for PTZ control.

**1b - Channels 1-4, Channels 5-8, Channels 9-12 & Channels 13-16:** CAT-5 or higher structured cable from optional HubSat4D enables video transmission from up to four (4) cameras.

**1a - Channels 1-8 (HubWay8CD) or Channels 1-16 (HubWay16CD):** CAT-5 or higher structured cable to Video/Balun Combiners at cameras 1-8 or 1-16. When using an optional HubSat4D any of the outputs can be utilized for the data transmission to PTZ's.

**1c - LED(s) 1-16:** Power indicators.

**1d - Output voltage switches:** Selects 24V AC/28V AC/OFF for each output.

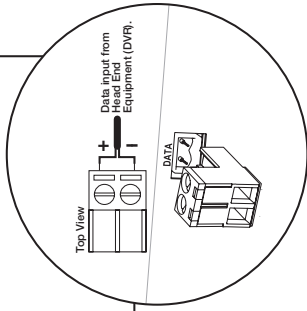

Front

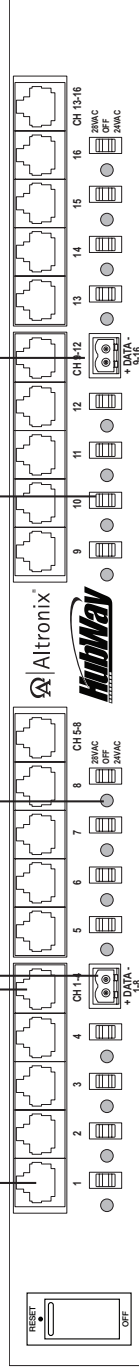

Rear



**1g - IEC 320 Connector:** 115VAC, 60Hz (grounded line cord included).

**1f - BNC Connector:** Video outputs to head end equipment (DVR).

## HubWayAv, HubWayAv2, HubWayDv, and HubWayDvi Video Balun/Combiners:

Altronix Model Number	Input Voltage from HubWay Unit	Output Voltage to Camera	Camera Type	Power LED
HubWayAv	*24VAC/28VAC	*24VAC/28VAC	*24VAC/28VAC	Green
HubWayAv2	*24VAC/28VAC	*24VAC/28VAC	*24VAC/28VAC	N/A
HubWayDv	*24VAC/28VAC	12VDC	12VDC cameras	Red
HubWayDvi	*24VAC/28VAC	12VDC electronically isolated	12VDC cameras without isolation	Red

\*Based on camera load and structured cable length.

Fig. 2

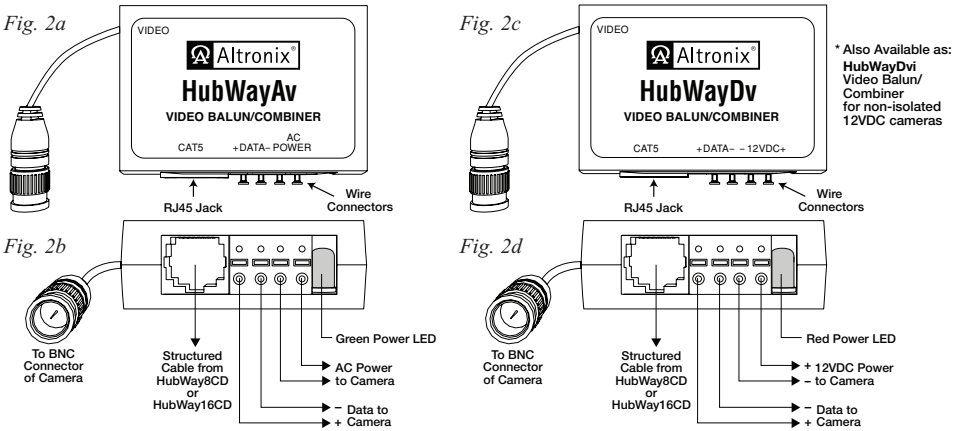
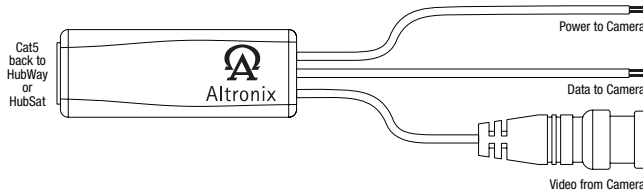
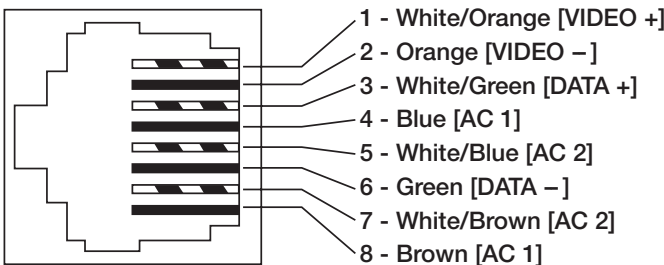

Fig. 2e HubWayAV2



HubWayAv/HubWayAv2 passes AC voltage from pins 4, 5, 7, 8 to terminals marked [AC Power] (Fig. 3, pg. 5). HubWayDv/HubWayDvi converts AC voltage to DC voltage from pins 4, 5, 7, 8 to terminals marked [- 12VDC +] (Fig. 3, pg. 5).

Fig. 3 CAT-5 Structured Cable Wiring Color Codes and PIN Configurations



# Typical Applications:

Fig. 4

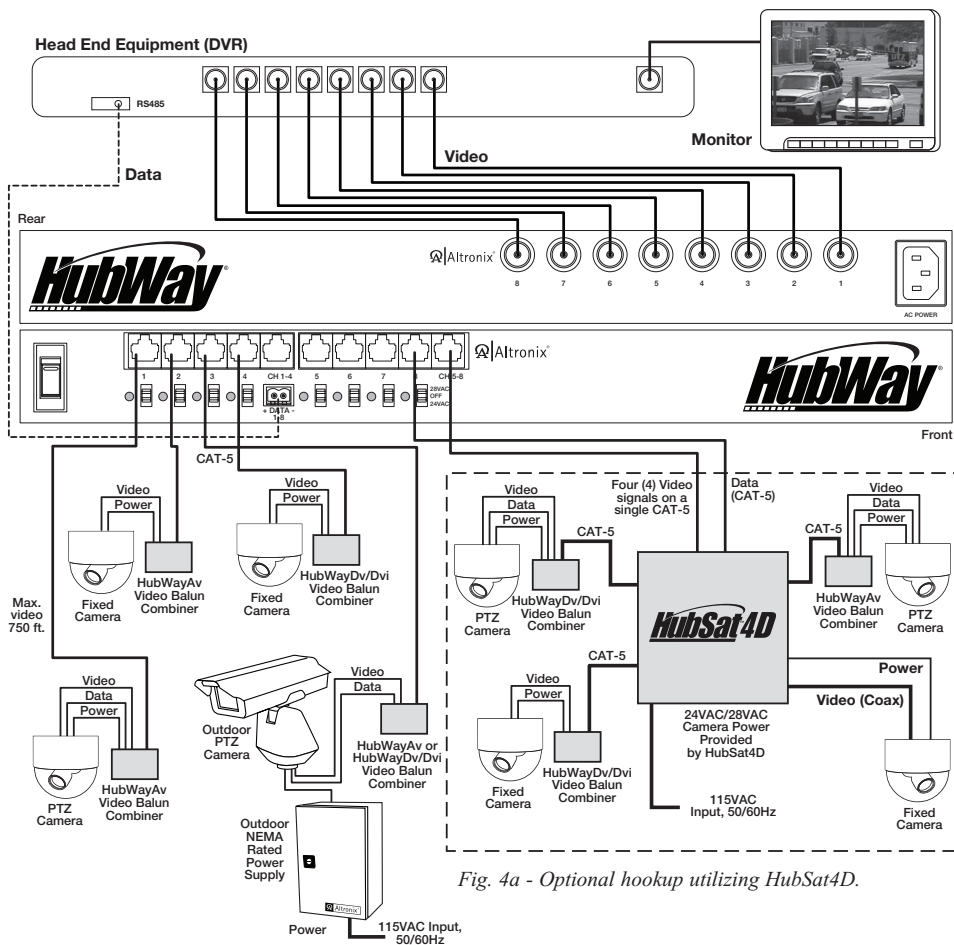

Fig. 4a - Optional hookup utilizing HubSat4D.

# 1U EIA 19" Rack Mount Chassis Dimensions (H x W x D approximate):

1.625" x 19.125" x 8.5" (41.3mm x 486mm x 216mm)

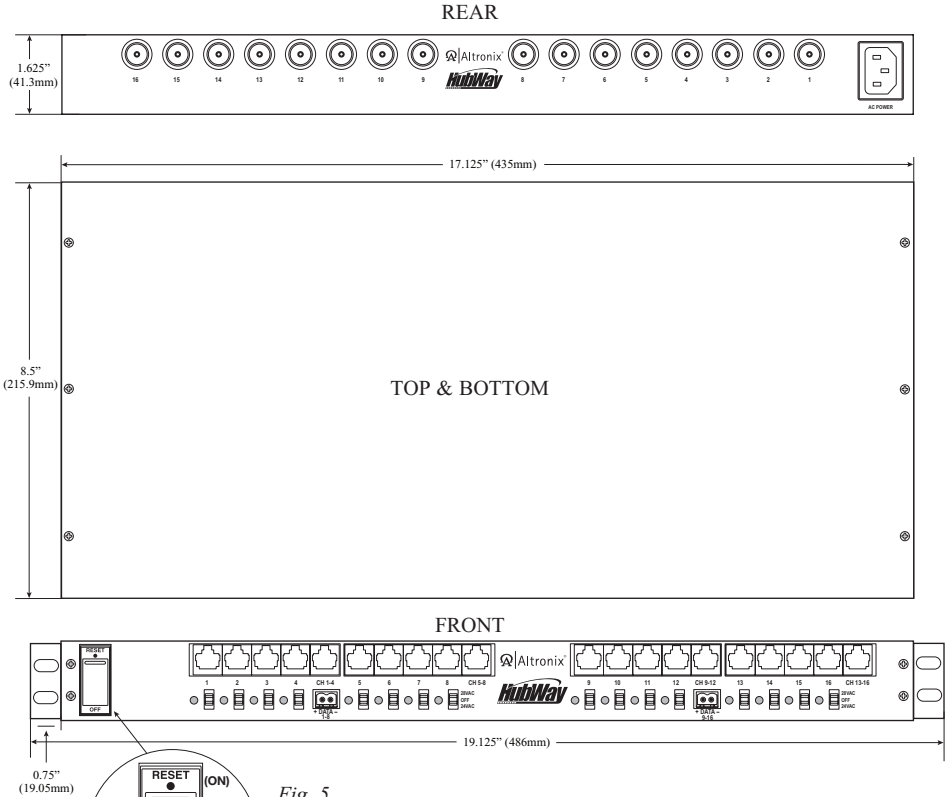

Fig. 5

Illuminated master power disconnect circuit breaker:

- OFF position Circuit breaker tripped – Switch not illuminated.
- RESET (ON) position – Switch illuminated.



The lightning flash with arrowhead symbol within an equilateral triangle is intended to alert the user to the presence of an insulated DANGEROUS VOLTAGE within the product's enclosure that may be of sufficient magnitude to constitute an electric shock.



The exclamation point within an equilateral triangle is intended to alert the user to the presence of important operating and maintenance (servicing) instructions in the literature accompanying the appliance.



**CAUTION**  
RISK OF ELECTRIC SHOCK  
DO NOT OPEN



**CAUTION:** To reduce the risk of electric shock do not open enclosure. There are no user serviceable parts inside. Refer servicing to qualified service personnel.

## Mounting Options:

### Rack Mount Installation

1. Remove and discard factory installed screws from both sides of rack chassis (Fig. 6a).
2. Install mounting brackets (A) on the left and right side of rack chassis using the four (4) flat head screws (B) (included) (Fig. 6b).
3. Place unit into desired EIA 19" rack position and secure with mounting screws (not included) (Fig. 6c).

Fig. 6

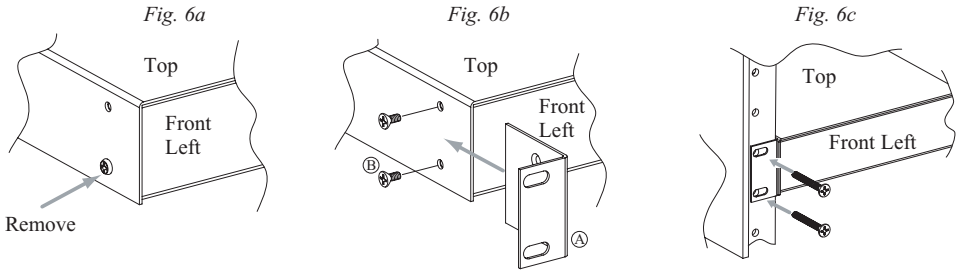

### Wall Mount Installation

1. Install mounting brackets (A) on the left and right side of rack chassis using four (4) flat head screws (B) (included) (Fig. 7a).
  2. Place unit at desired location and secure with #6 size screws or larger (not included) (Fig. 7b).
- Caution:** It is necessary to make sure mounting screws are securely fastened to a beam when installing the unit vertically.

Fig. 7

Fig. 7a

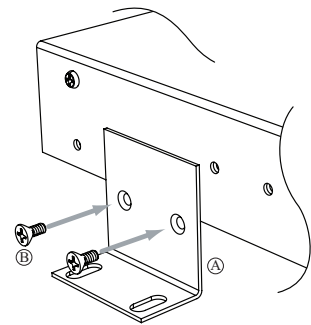
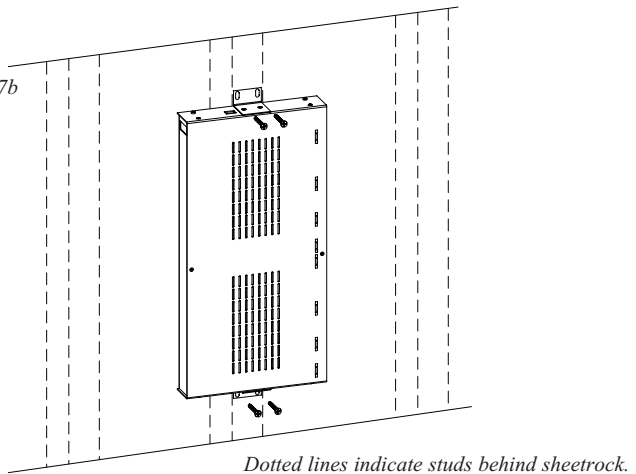

Fig. 7b





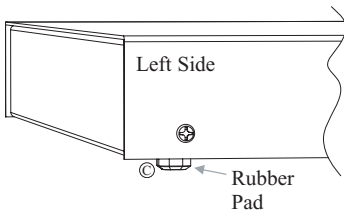

### Shelf Installation

- 1- Position and affix rubber pads (C) (included) at each corner on the bottom of the unit (Fig. 8).
- 2- Place unit in desired location.

Fig. 8



### Mounting Hardware (Included):

-  (A) Two (2) mounting brackets
-   (B) Six (6) flat head screws for mounting brackets.
-  (C) Four (4) rubber pads.

Altronix is not responsible for any typographical errors.

140 58th Street, Brooklyn, New York 11220 USA | phone: 718-567-8181 | fax: 718-567-9056  
 website: www.altronix.com | e-mail: info@altronix.com | Lifetime Warranty | Made in U.S.A.  
 IHubWay8CD/HubWay16CD E11R



**MEMBER**

HubWay8CD / HubWay16CD