



eFlow3N Series

Power Supply/Chargers

Models Include:

eFlow3N/eFlow3NX

- 2A @ 12VDC or 24VDC Class 2 Power-Limited Output

eFlow3N4/eFlow3NX4

- 2A @ 12VDC or 24VDC
- Four (4) Class 2 Power-Limited Fused Outputs

eFlow3N4D/eFlow3NX4D

- 2A @ 12VDC or 24VDC
- Four (4) Class 2 Power-Limited PTC Outputs

Installation Guide



Rev. 3NRP013019

More than just power.™

Installing Company: _____ Service Rep. Name: _____

Address: _____ Phone #: _____

Overview:

Altronix eFlow3N power supply/chargers convert a 120VAC / 60Hz input to a 12VDC or 24VDC nominal output (see *Power Supply Configuration Reference Chart and Specifications*).

eFlow3N Series Power Supply Configuration Reference Chart:

Altronix Model Number	Nominal DC Outputs				Maximum Supply Current for Main and Aux. Outputs (A)	Power-Limited Output	Input Rating: 120VAC, 60Hz	Input Fuse Rating	Battery Fuse Rating	Ripple Voltage (mV) Under low battery condition	Power Distribution Module	Number of Outputs	Fused Outputs Ratings	Auto-Resettable PTC Outputs Ratings	Accommodates up to 7AH Batteries	Accommodates up to 12AH Batteries
	[DC]		[AUX]													
	12VDC Output Range (V)	24VDC Output Range (V)	12VDC Output Range (V)	24VDC Output Range (V)												
eFlow3N	10.13-13.2	20.28-26.39	10.15-13.2	20.2-26.39	2A	✓	3.5A	5A/250V	3A/32V	960	N/A	1	-	-	✓	-
eFlow3NX	13.2	26.39	13.2	26.39	2A	✓	3.5A	5A/250V	3A/32V	960	N/A	1	-	-	-	✓
eFlow3N4	10.13-13.2	20.28-26.39	10.15-13.2	20.2-26.39	2A	✓	3.5A	5A/250V	3A/32V	960	PD4UL	4	2A	-	✓	-
eFlow3NX4	13.2	26.39	13.2	26.39	2A	✓	3.5A	5A/250V	3A/32V	960	PD4UL	4	2A	-	-	✓
eFlow3N4D	9.78-13.2	20.0-26.39	10.15-13.2	20.2-26.39	2A	✓	3.5A	5A/250V	3A/32V	960	PD4ULCB	4	-	2A	✓	-
eFlow3NX4D	13.2	26.39	13.2	26.39	2A	✓	3.5A	5A/250V	3A/32V	960	PD4ULCB	4	-	2A	-	✓

These units are classified as Power-Limited stand alone power supplies with stand-by battery and they are suitable to power: sensors, electro-mechanical devices (e.g. electric door strikes) defined in the National Electrical Code/NFPA70/NFPA72 and the Canadian Electrical Code, Part 1.

UL Listings for US Installations:

UL 294, 7th edition - UL Listed for Access Control System Units.

Access Control Performance Levels:

Destructive Attack - I; Endurance - I; Line Security - I;

Stand-by Power: 7AH - II, 12AH - III, 40AH/65AH - IV.

UL 603 - UL Listed for Power Supplies for Use with Burglar-Alarms Systems.

UL 1481 - UL Listed for Power Supplies for Fire Protective Signaling Systems.



UL Listings for Canadian Installations:

ULC-S318-96 - Power Supplies for Burglar Alarm Systems. Also suitable for Access Control.



California State Fire Marshal



European Conformity



Factory Mutual Approved (eFlow3N and eFlow3NX only).

Stand-by Specifications:

Battery	Burg. Applications 4 hr. Stand-by/ 15 min. Alarm	Fire Applications 24 hr. Stand-by/ 5 min. Alarm	Access Control Applications Stand-by
7AH	0.4A/2A	N/A	1.5 Hours/2A
12AH (for eFlow3NX refer to Fig. 7, pg. 10)	1A/2A	0.3A/2A	3.5 Hours/2A
40AH	2A/2A	1.2A/2A	Over 4 Hours/2A
65AH	2A/2A	1.5A/2A	Over 4 Hours/2A

Specifications:

Input:

- 120VAC, 60Hz.

Output:

- For output voltage and supply current refer to *eFlow3N series Power Supply Configuration Reference Chart, pg. 2.*
- Auxiliary Class 2 power-limited output rated @ 1A (unswitched).
- Overvoltage protection.

Battery Backup:

- Built-in charger for sealed lead acid or gel type batteries.
- Maximum charge current 1.54A.
- Automatic switch over to stand-by battery when AC fails.
Transfer to stand-by battery power is instantaneous with no interruption.

Fuse/PTC Ratings:

- Refer to *eFlow3N Series Power Supply Configuration Reference Chart, pg. 2.*

Fire Alarm Disconnect:

- Supervised Fire Alarm disconnect (latching or non-latching) 10K EOL resistor. Operates on a normally open (NO) or normally closed (NC) trigger.

Supervision:

- AC fail supervision (form “C” contacts).
- Battery fail & presence supervision (form “C” contacts).
- Low power shutdown. Shuts down DC output terminals if battery voltage drops below 71-73% for 12V units and 70-75% for 24V units (depending on the power supply). Prevents deep battery discharge.

Visual Indicators:

- Green AC Power LED indicates 120VAC present.
- AC input and DC output LED indicators.

Additional Features:

- Short circuit and overload protection.
- Unit is complete with power supply, enclosure, battery leads, and cam lock.

Enclosure Dimensions (approximate H x W x D):

eFlow3N, eFlow3N4, eFlow3N4D:

13.5" x 13" x 3.25"
(342.9mm x 330.2mm x 82.6mm).

eFlow3NX, eFlow3NX4, eFlow3NX4D:

15.5" x 12" x 4.5"
(393.7mm x 304.8mm x 114.3mm).

Installation Instructions:

Wiring methods shall be in accordance with the National Electrical Code/NFPA 70/NFPA 72/ANSI, The Canadian Electrical Code, Part 1 and with all local codes and authorities having jurisdiction. The product must be located indoors within the protected premises.

1. Mount unit in desired location. Mark and predrill holes in the wall to line up with the top two keyholes in the enclosure. Install two upper fasteners and screws in the wall with the screw heads protruding. Place the enclosure's upper keyholes over the two upper screws, level and secure. Mark the position of the lower two holes. Remove the enclosure. Drill the lower holes and install the two fasteners. Place the enclosure's upper keyholes over the two upper screws. Install the two lower screws and make sure to tighten all screws (*Enclosure Dimensions, pgs. 11-12*). Secure enclosure to earth ground.
2. Set desired DC output voltage by setting SW1 to the appropriate position on the power supply board (*Fig. 1i, pg. 5*).
3. Connect unswitched AC power (120VAC 60Hz) to terminals marked [L, N] (*Fig. 1a, pg. 5*). Green “AC” LED on power supply board will turn on. This light can be seen through the LED lens on the door of the enclosure. Use 14 AWG or larger for all power connections. Secure green wire lead to earth ground.

Keep power-limited wiring separate from non power-limited wiring (120VAC 60Hz Input, Battery Wires). Minimum 0.25" spacing must be provided.

CAUTION: Do not touch exposed metal parts. Shut branch circuit power before installing or servicing equipment. There are no user serviceable parts inside. Refer installation and servicing to qualified service personnel.

For Fire Alarm applications the outputs are “Special Applications” only, see list (*refer to Appendix A, pg. 13*).

4. Measure output voltage before connecting devices. This helps avoiding potential damage.
5. Connect devices to be powered:
 - a. For eFlow3N/eFlow3NX connect devices to terminals marked [– DC +] (*Fig. 1h, pg. 5*).
 - b. For other Power Distribution Models connect devices to be powered to terminal pairs 1 to 4 marked [1P & 1N] through [4P & 4N] (*Fig. 3a & 3b, pg. 6*) carefully observing correct polarity.

For auxiliary device connection this output will not be affected by Low Power Disconnect or Fire Alarm Interface. Connect device to terminals marked [+ AUX –] (*Fig. 1f, pg. 5*).

6. For Access Control applications batteries are optional. When batteries are not used, a loss of AC will result in the loss of the output voltage. When the use of stand-by batteries is desired, they must be lead acid or gel type. Connect battery to terminals marked [- BAT +] (Fig. 1g, pg. 5). Use two (2) 12VDC batteries connected in series for 24VDC operation (battery leads included). Use batteries - Casil CL1270 (12V/7AH), CL12120 (12V/12AH), CL12400 (12V/40AH), CL12650 (12V/65AH) batteries or UL recognized BAZR2 batteries of an appropriate rating.
7. Connect appropriate signaling notification devices to AC FAIL & BAT FAIL (Fig. 1b, pg. 5) supervisory relay outputs.
8. To delay AC reporting for 2 hrs. set DIP switch [AC Delay] to OFF position (Fig. 1c, pg. 5).
To delay AC reporting for 1 min. set DIP switch [AC Delay] to ON position (Fig. 1c, pg. 5).
Note: Must be set to ON position for Burglar Alarm Applications.
9. To enable Fire Alarm Disconnect set DIP switch [Shutdown] to ON position (Fig. 1c, pg. 5).
To disable Fire Alarm Disconnect set DIP switch [Shutdown] to OFF position (Fig. 1c, pg. 5).
10. Trigger terminals are end of a line resistor supervised (10k ohms). Opening or shorting trigger terminals will cause [DC] output to shutdown (Fig. 1d, pg. 5).
11. Place a jumper for non-latching FACP. A momentary short on these terminals resets FACP latching [Trigger EOL Shutdown] (Fig. 1e, pg. 5).
12. For Access Control Applications: mount UL Listed tamper switch (Altronix Model TS112 or equivalent) at the top of the enclosure. Slide tamper switch bracket onto the edge of the enclosure approx. 2" from the right side (Fig. 4, pg. 7 or Fig. 6, pg. 9). Connect tamper switch wiring to the Access Control Panel input or the appropriate UL Listed reporting device.

Wiring:

Use 18 AWG or larger for all low voltage power connections.

Note: Take care to keep power-limited circuits separate from non power-limited wiring (120VAC, Battery).

Maintenance:

Unit should be tested at least once a year for the proper operation as follows:

Output Voltage Test: Under normal load conditions, the DC output voltage should be checked for proper voltage level eFlow3N: 12VDC or 24VDC nominal rated @ 2A max.

Battery Test: Under normal load conditions check that the battery is fully charged, check specified voltage (12VDC @ 13.2 or 24VDC @ 26.4) both at battery terminal and at the board terminals marked [- BAT +] to ensure that there is no break in the battery connection wires.

Note: Maximum charging current under discharges is 1.54A.

Note: Expected battery life is 5 years, however it is recommended changing batteries in 4 years or less if needed.

LED Diagnostics:

Power Supply/Charger

Red (DC)	Green (AC/AC1)	Power Supply Status
ON	ON	Normal operating condition.
ON	OFF	Loss of AC. Stand-by battery is supplying power.
OFF	ON	No DC output.
OFF	OFF	Loss of AC. Discharged or no stand-by battery. No DC output.

Power Distribution Module

Green (AC)	Power Distribution Module Status
ON	Normal operating condition.
OFF	No Power Output.

Terminal Identification:

Power Supply/Charger

Terminal Legend	Function/Description
L, N	Connect 120VAC 60Hz to these terminals: L to hot, N to neutral (non power-limited) (Fig. 1a, pg. 5).
– DC +	12VDC or 24VDC nominal @ 2A continuous output (power-limited output) (Fig. 1h, pg. 5).
Trigger EOL Supervised	Fire Alarm Interface trigger input from a short or FACP. Trigger inputs can be normally open, normally closed from an FACP output circuit (power-limited input) (Fig. 1d, pg. 5).
NO, GND RESET	FACP interface latching or non-latching (power-limited) (Fig. 1e, pg. 5).
+ AUX –	Auxiliary Class 2 power-limited output rated @ 1A (unswitched) (Fig. 1f, pg. 5).
AC Fail NC, C, NO	Indicates loss of AC power, e.g. connect to audible device or alarm panel. Relay normally energized when AC power is present. Contact rating 1A @ 30VDC (power-limited) (Fig. 1b, pg. 5).
Bat Fail NC, C, NO	Indicates low battery condition, e.g. connect to alarm panel. Relay normally energized when DC power is present. Contact rating 1A @ 30VDC. A removed battery is reported within 5 minutes. Battery reconnection is reported within 1 minute (power-limited) (Fig. 1b, pg. 5).
– BAT +	Stand-by battery connections. Maximum charge current 1.54A (non power-limited) (Fig. 1g, pg. 5).

Power Distribution Module

Terminal Legend PD4UL/PD4ULCB	Function/Description
1P to 4P	Positive DC power outputs.
1N to 4N	Negative DC power outputs.

Fig. 1 - eFlow3N Board Configuration

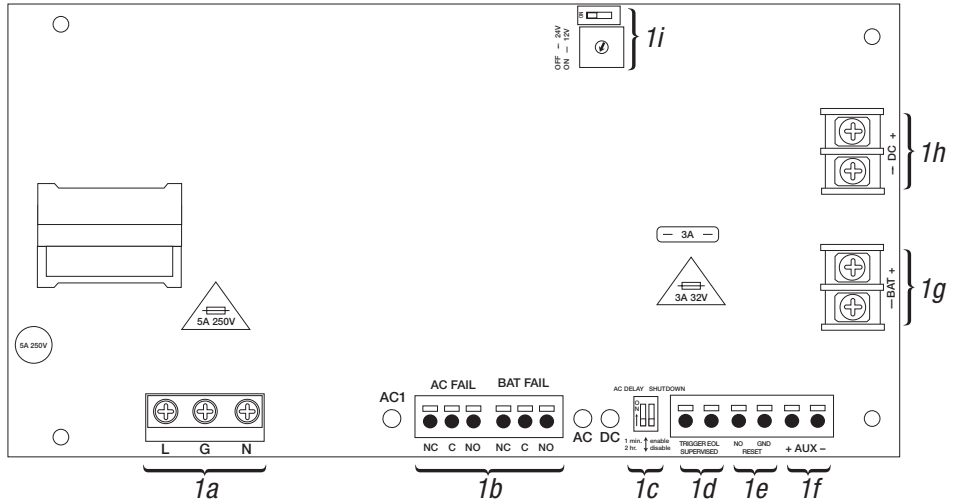

Trouble/Time Limited Warning of Stand-by Batteries:

For compliance with ULC S318-96, the Time Limited Warning circuit must be connected for local or remote annunciation with an Amber or Red LED to indicate DC Trouble (low battery, loss of battery or when 95% of the stand-by battery has been depleted). Connect the circuit to the Batt Fail relay contacts to an appropriate input of a UL Listed Burglar Alarm or Access Control Panel. The following figure shows the circuitry needed for local annunciation.

Fig. 2 - Battery Trouble Indication

For Canadian use, a red indicating lamp must be visible from the exterior of this enclosure.

Wire one leg of a UL Listed, power-limited power source to the indicating lamp.

Wire the second leg of the power source to the indicating lamp in series with the battery fail relay contact terminals marked [BAT FAIL - C, NO] (Fig. 2, pg. 6).

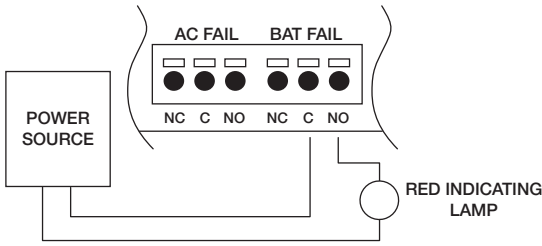

Power Distribution Module(s):

Fig. 3a - PD4UL Power Distribution Board

Replace fuses with the same type and rating 3.5A/250V

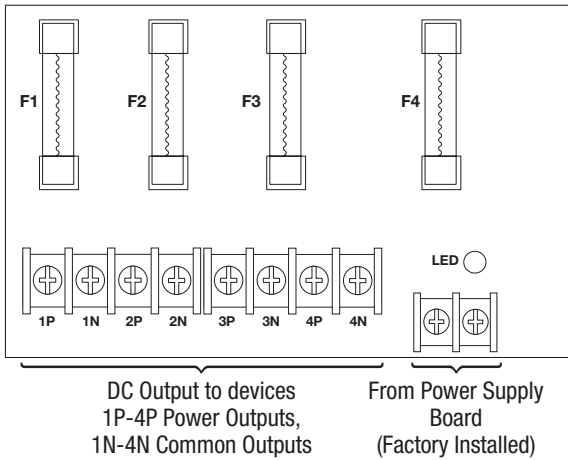
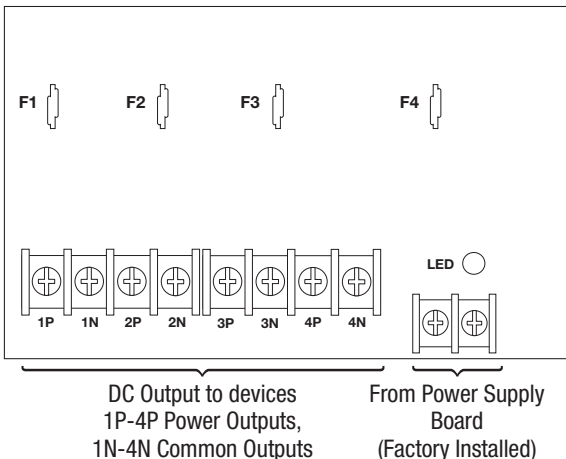

Fig. 3b - PD4ULCB - Power Distribution Board



NEC Power-Limited Wiring Requirements for eFlow3N Models:

Power-limited and non power-limited circuit wiring must remain separated in the cabinet. All power-limited circuit wiring must remain at least 0.25" away from any non power-limited circuit wiring. Furthermore, all power-limited circuit wiring and non power-limited circuit wiring must enter and exit the cabinet through different conduits. One such example of this is shown below. Your specific application may require different conduit knockouts to be used. Any conduit knockouts may be used. For power-limited applications use of conduit is optional. All field wiring connections must be made employing suitable gauge CM or FPL jacketed wire (or equivalent substitute). Optional UL Listed battery enclosure must be mounted adjacent to the power supply via Class 1 wiring methods. For Canadian installations use shielded wiring for all connections.

Note: Refer to wire handling drawing below for the proper way to install the CM or FPL jacketed wire (Fig. 5a).

Fig. 5

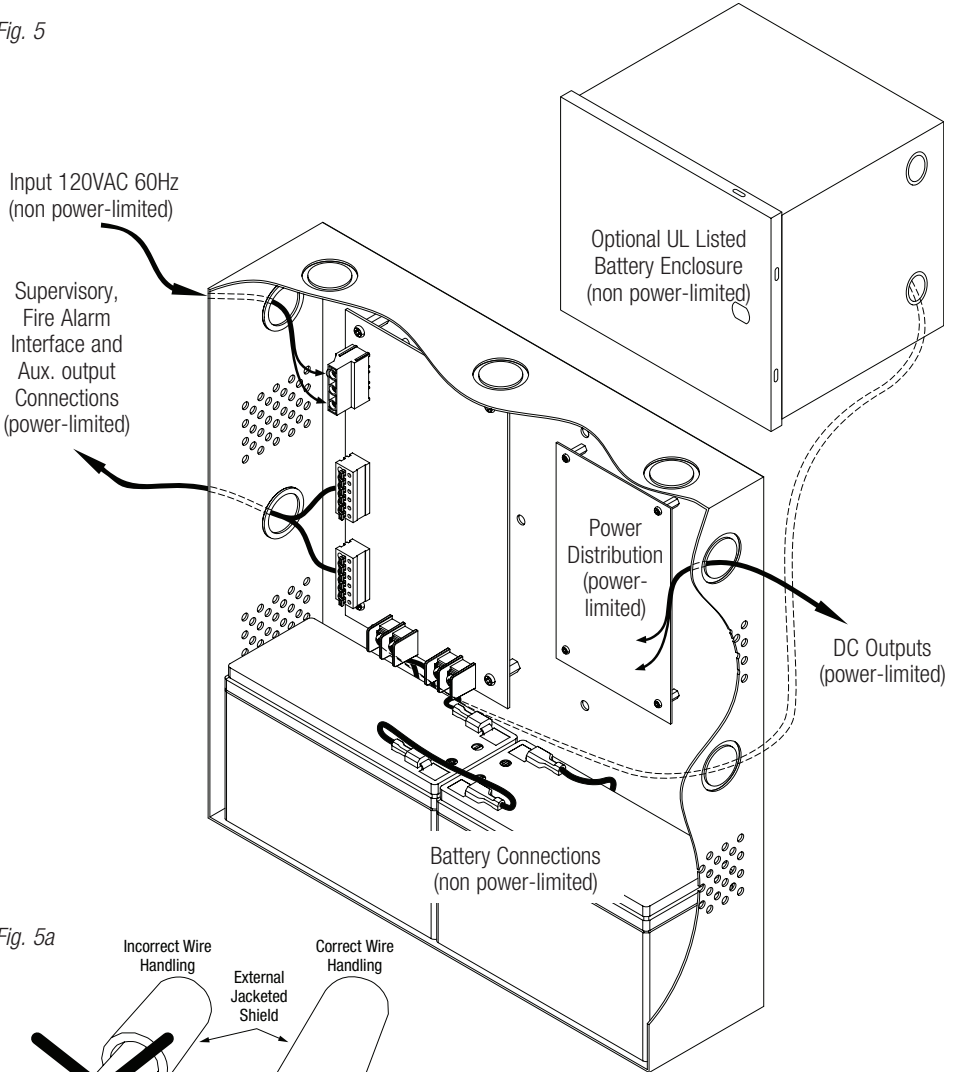

Fig. 5a

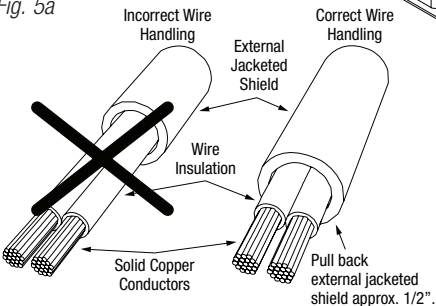
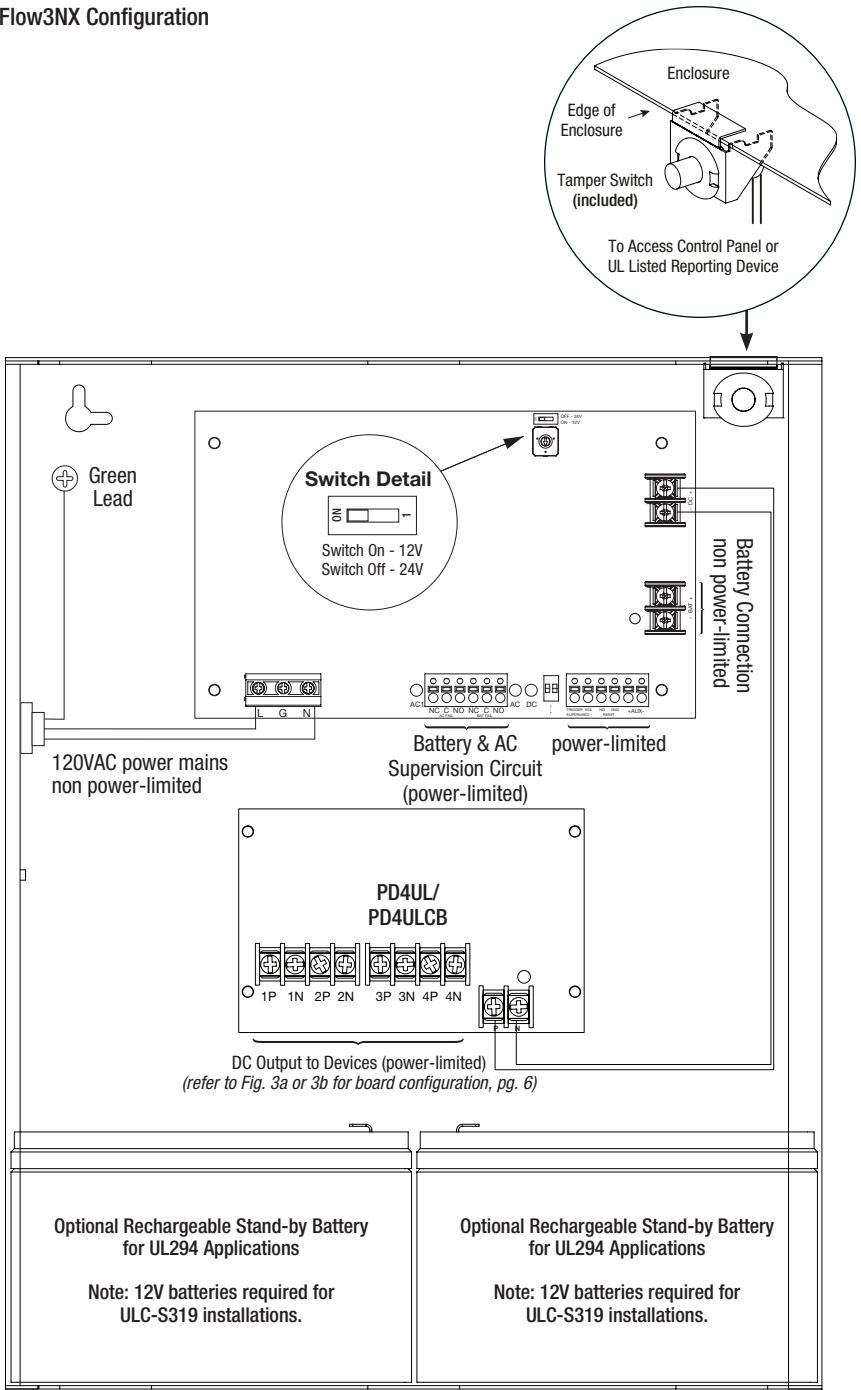

Fig. 6 - eFlow3NX Configuration



CAUTION: When power supply board is set for 12VDC use only one (1) 12VDC stand-by battery. Keep power-limited wiring separate from non power-limited. Use minimum 0.25" spacing. 12AH Rechargeable batteries are the largest batteries that can fit in this enclosure. A UL listed external battery enclosure must be used if using 40AH or 65AH batteries.

NEC Power-Limited Wiring Requirements for eFlow3NX Models:

Power-limited and non power-limited circuit wiring must remain separated in the cabinet. All power-limited circuit wiring must remain at least 0.25" away from any non power-limited circuit wiring. Furthermore, all power-limited circuit wiring and non power-limited circuit wiring must enter and exit the cabinet through different conduits. One such example of this is shown below. Your specific application may require different conduit knockouts to be used. Any conduit knockouts may be used. For power-limited applications use of conduit is optional. All field wiring connections must be made employing suitable gauge CM or FPL jacketed wire (or equivalent substitute). Optional UL Listed battery enclosure must be mounted adjacent to the power supply via Class 1 wiring methods. For Canadian installations use shielded wiring for all connections.

Note: Refer to wire handling drawing below for the proper way to install the CM or FPL jacketed wire (Fig. 7a).

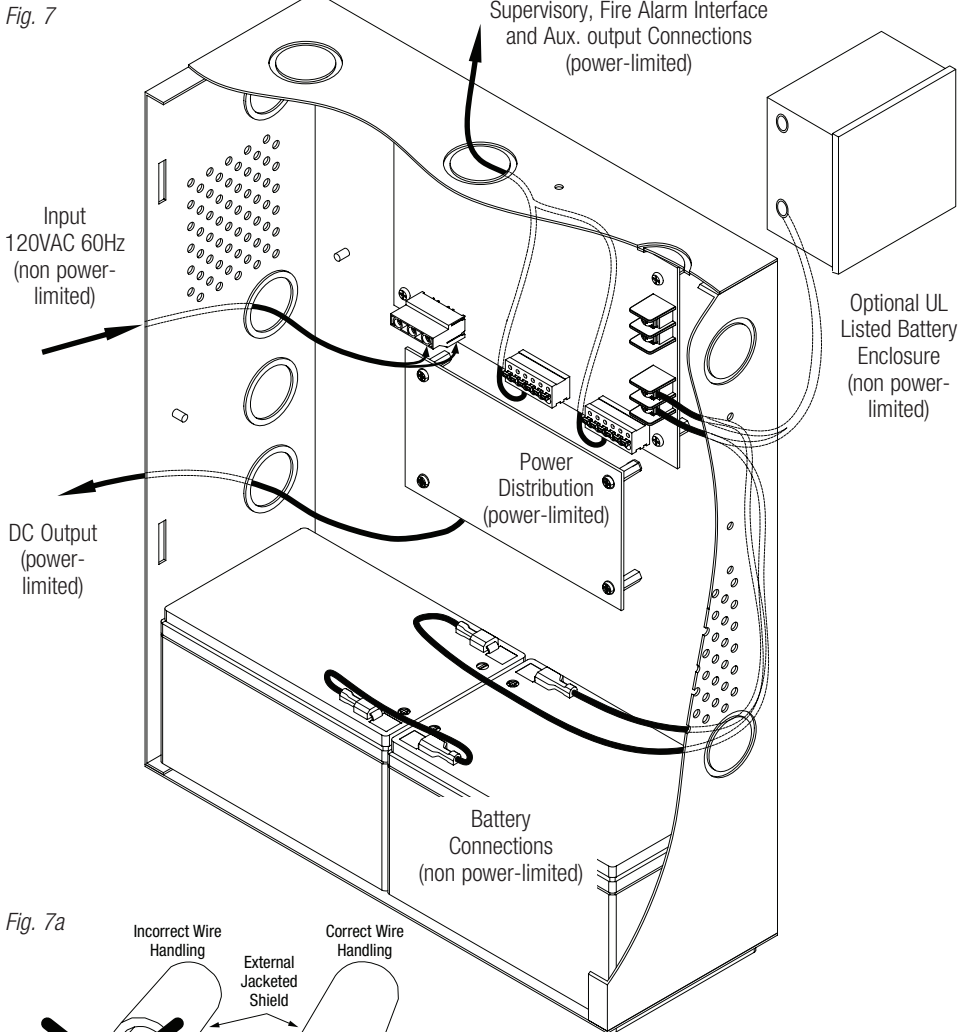
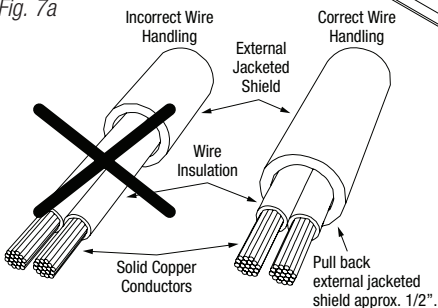

Fig. 7a



Enclosure Dimensions (BC300):

eFlow3N, eFlow3N4, eFlow3N4D

13.5" x 13" x 3.25" (342.9mm x 330.2mm x 82.6mm)

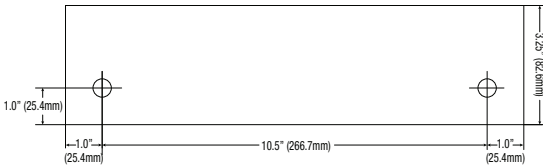
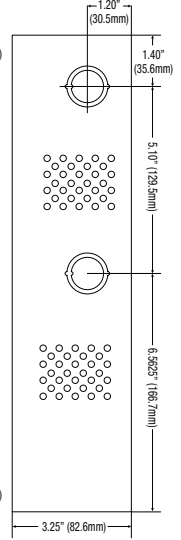
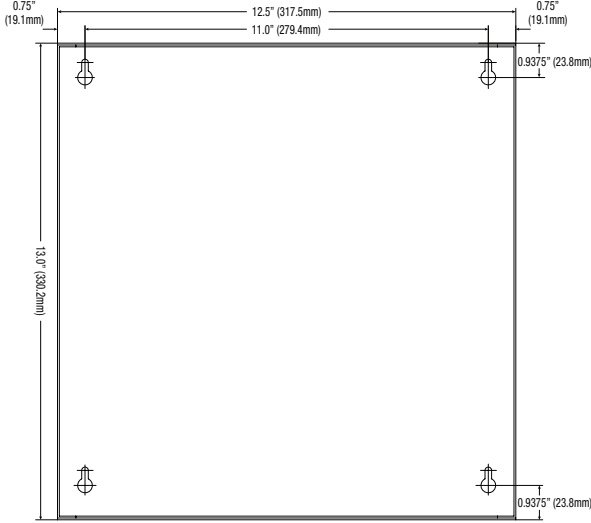
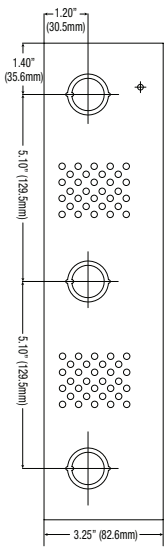
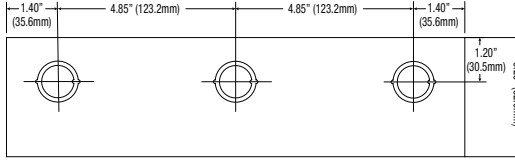

Enclosure Dimensions (BC400):

eFlow3NX, eFlow3NX4, eFlow3NX4D

15.5" x 12" x 4.5" (393.7mm x 304.8mm x 114.3mm)

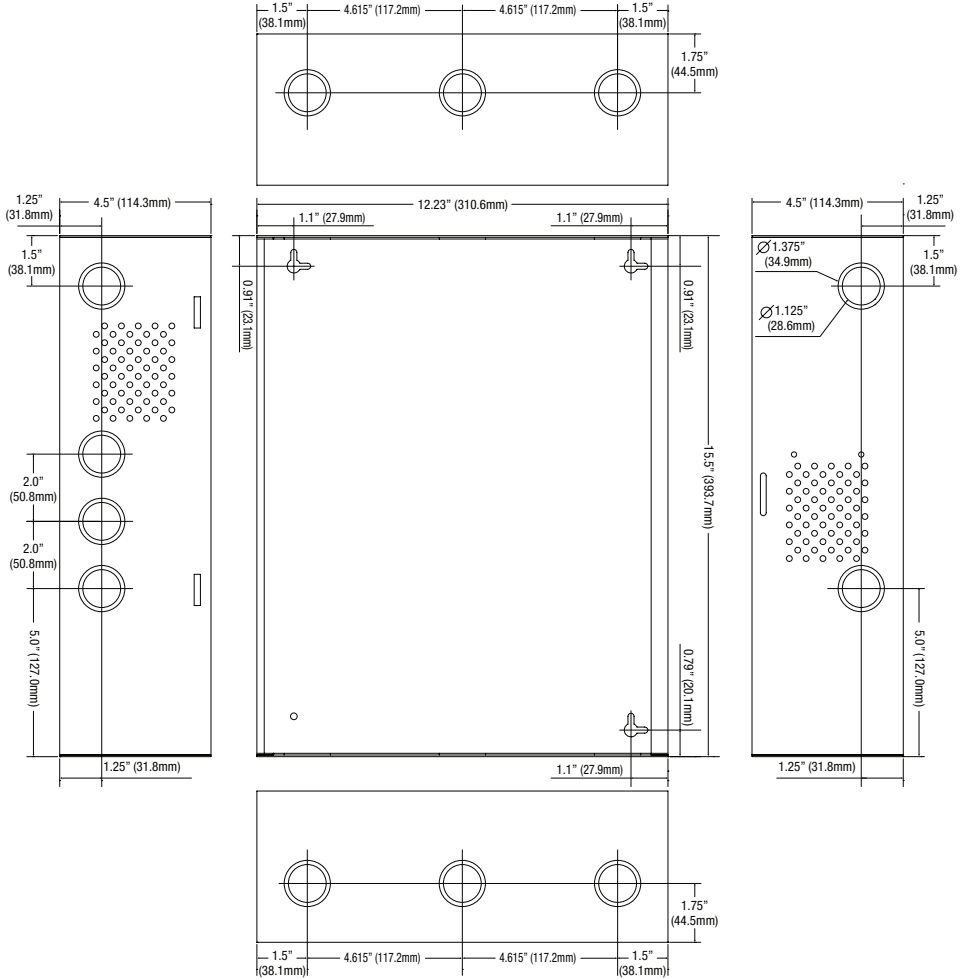

Appendix A - UL Listed Compatible Devices

A.1 Four (4) Wire Smoke Detectors

Table A-1 below lists four (4) wire smoke detectors compatible with eFlow3N output.

System Sensor Smoke Detector/Base	Detector Type	Max Stand-by Current (mA)	Alarm Current (mA)
B112LP	Base	0.12	36
B114LP	Base	*	*
B404B	Base	*	*
DH100ACDC	Photoelectric	0.15	0.70
DH100ACDCLP	Photoelectric	0.15	0.70
DH100ACDCLPW	Photoelectric	0.15	0.70
DH400ACDCI	Ionization Duct	25	95
DH400ACDCP	Photoelectric Duct	25	95
1112/24/D	Ionization	0.05	50
1424	Ionization	0.10	41
1451 (w/B402B Base)	Ionization	0.10	39
2112/24ATR	Photoelectric	0.50	60/70
2112/24AIR	Photoelectric	0.50	60/70
2112/24/D	Photoelectric	0.05	50
2112/24T/D	Photoelectric w/135° Thermal	0.05	50
2112/24TSRB	Photoelectric w/135° Thermal Supervisory Relay	15	45
2312/24TB	Photoelectric	0.12	50
2412 (12 volt)	Photoelectric	0.12	77
2424	Photoelectric	0.10	41
2451	Photoelectric	0.10	39
2451TH (with/B402B Base)	Photoelectric	0.10	39
2W-MOD	Loop Test/Maintenance Mod.	30	50
4W-B (12/24 volt)	Photoelectric I ³	0.05	23
4WT-B (12/24 volt)	Photoelectric I ³ w/Therm	0.05	23
4WTA-B (12/24 volt)	I ³ Photo w/Therm/Sounder	0.05	35
4WTR-B (12/24 volt)	I ³ Photo w/Therm/Relay	0.05	35
4WITAR-B (12/24 volt)	I ³ Photo w/Isolated Therm/Sounder/Relay	0.05	50
2W-MOD2	I ³ Loop Test/Maintenance Mod.	0.05	*
RRS-MOD	I ³ Reversing Relay/Sync Module	0.05	*
6424	Projected Beam	10	28.4
Beam 1224(S)	Projected Beam	17	38.5

* Contact manufacturer for current draws.

A.2 Relays

Table A-2 below lists relays compatible with eFlow3N output.

Manufacturer	Model	Current (mA)	Manufacturer	Model	Current (mA)
System Sensor	PR-1**	15	System Sensor	R-20T**	40
	PR-2*	30		R-24T**	40
	PR-3*	30		R-10E**	23
	EOLR-1	30		R-14E**	23
	R-10T**	23		R-20E**	40
	R-14T**	23		R-24E**	40

* Compatible only with eFlow3N, eFlow3NX, eFlow3N4, eFlow3NX4.

** Compatible only when unit is set for 24VDC.



eFlow Power Supply/Chargers can be Controlled and Monitored while Reporting Power/Diagnostics from Anywhere over the Network...

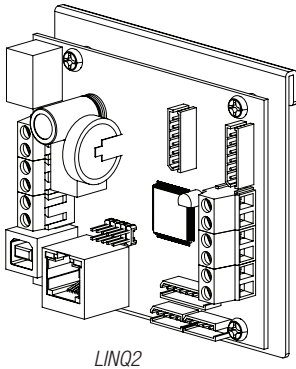

LINQ2



LINQ2 - Network Communication Module

LINQ2 provides remote IP access to real-time data from eFlow power supply/chargers to help keep systems up and running at optimal levels. It facilitates fast and easy installation and set-up, minimizes system downtime, and eliminates unnecessary service calls, which helps reduce Total Cost of Ownership (TCO) - as well as creating a new source of Recurring Monthly Revenue (RMR).

Features:

- UL Listed in the U.S. and Canada.
- Local or remote control of up to (2) two Altronix eFlow power output(s) via LAN and/or WAN.
- Monitor real time diagnostics: DC output voltage, output current, AC & battery status/service, input trigger state change, output state change and unit temperature.
- Access control and user management: Restrict read/write, Restrict users to specific resources
- Two (2) integral network controlled Form "C" Relays.
- Three (3) programmable input triggers: Control relays and power supplies via external hardware sources.
- Email and Windows Dashboard notifications
- Event log tracks history.
- Secure Socket Layer (SSL).
- Programmable via USB or web browser - includes operating software and 6 ft. USB cable.

LINQ2 Mounts Inside any eFlow Enclosure

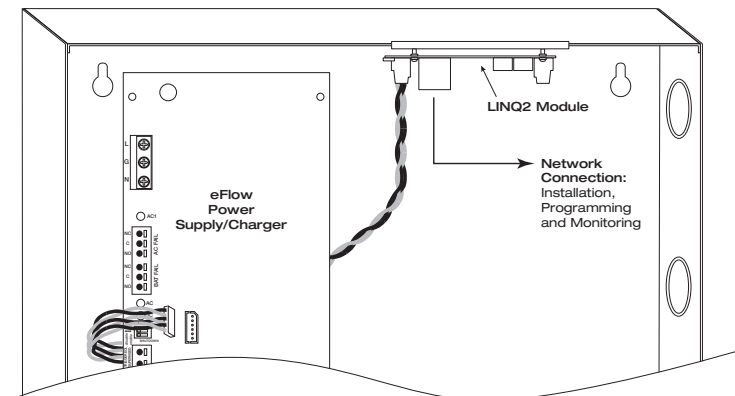

Notes:

Altronix is not responsible for any typographical errors.

140 58th Street, Brooklyn, New York 11220 USA | phone: 718-567-8181 | fax: 718-567-9056
website: www.altronix.com | e-mail: info@altronix.com | Lifetime Warranty
IleFlow3N Series G21U

eFlow3N Series Installation Guide



eFLOW Power Supply/Chargers Operating Guide

Models Include:

Model	Input 120VAC, 60Hz	Output		Power- Limited	Auxiliary Power-Limited Output (unswitched)	Ripple Voltage
		12VDC	24VDC			
eFlow3N, eFlow3N4, eFlow3N4D	3.5A	2A	2A	✓	1A	960mV
eFlow3NX, eFlow3NX4, eFlow3NX4D						

Overview:

The eFlow3N series power supply/chargers convert a 120VAC, 60Hz input to a 12VDC or 24VDC output.

Stand-by Specifications:

Battery	Burg. Applications 4 hr. Stand-by/ 15 min. Alarm	Fire Applications 24 hr. Stand-by/ 5 min. Alarm	Access Control Applications Stand-by
7AH	0.4A/2A	N/A	1.5 Hours/2A
12AH	1A/2A	0.3A/2A	3.5 Hours/2A
40AH	2A/2A	1.2A/2A	Over 4 Hours/2A
65AH	2A/2A	1.5A/2A	Over 4 Hours/2A

Battery Backup:

- Built-in charger for sealed lead acid or gel type batteries.
- Maximum charge current 1.54A.
- Automatic switch over to stand-by battery when AC fails.
Transfer to stand-by battery power is instantaneous with no interruption.

LED Diagnostics:

Red (DC)	Green (AC/AC1)	Power Supply Status
ON	ON	Normal operating condition.
ON	OFF	Loss of AC. Stand-by battery supplying power.
OFF	ON	No DC output.
OFF	OFF	Loss of AC. Discharged or no stand-by battery. No DC output.

Installing Company: _____ Service Rep. Name: _____
Address: _____ Phone #: _____

Refer to the eFlow Power Supply/Chargers Installation Guide: IleFlow3N Series, Rev. 3NRP013019 for complete instructions. This sheet is to be removed, framed and posted next to the unit.