

# ALTV2416 Series

## 16-Output CCTV Power Supplies

### Models Include:

#### ALTV2416

- 24VAC @ 8A (200VA) or 28VAC @ 7A (200VA).
- Sixteen (16) Fuse Protected Outputs.

#### ALTV2416350

- 24VAC @ 14A (350VA) or 28VAC @ 12.5A (350VA).
- Sixteen (16) Fuse Protected Outputs.

#### ALTV2416600

- 24VAC @ 28A (700VA) or 28VAC @ 25A (700VA).
- Sixteen (16) Fuse Protected Outputs.

#### ALTV2416CB

- 24VAC @ 8A (100VA) or 28VAC @ 7A (200VA).
- Sixteen (16) PTC Protected Outputs.

#### ALTV2416350CB

- 24VAC @ 14A (350VA) or 28VAC @ 12.5A (350VA).
- Sixteen (16) PTC Protected Outputs.

#### ALTV2416600CB

- 24VAC @ 28A (700VA) or 28VAC @ 25A (700VA).
- Sixteen (16) PTC Protected Outputs.

## Installation Guide



Rev. 071712



More than just power.™

Installing Company: \_\_\_\_\_ Service Rep. Name: \_\_\_\_\_

Address: \_\_\_\_\_ Phone #: \_\_\_\_\_

## Overview:

Altronix ALTV2416 Series CCTV Power Supplies provide 24VAC or 28VAC distributed via sixteen(16) fuse or PTC protected outputs for powering CCTV cameras, heaters and other video accessories.

### Sixteen (16) Output ALTV2416 Reference Chart:

Altronix Model Number	Output Voltage	Total Output Current (Power)	Number of Outputs	PTC Protected Outputs (auto-resettable)	Fuse Protected Outputs	Output Current (max. per output)	Main Fuse Ratings	115VAC 50/60Hz Input Current
ALTV2416	24VAC	8A	16	-	✓	3.5A	Two (2) 5A/250V	1.9A
	28VAC	7A						
ALTV2416CB	24VAC	8A		✓	-	2.5A		
	28VAC	7A						
ALTV2416350	24VAC	14A		-	✓	3.5A	Two (2) 15A/250V	2.7A
	28VAC	12.5A						
ALTV2416350CB	24VAC	14A		✓	-	2.5A		
	28VAC	12.5A						
ALTV2416600	24VAC	28A		-	✓	3.5A	Two (2) 15A/250V	5.4A
	28VAC	25A						
ALTV2416600CB	24VAC	28A		✓	-	2.5A		
	28VAC	25A						

### Specifications:

#### Input:

- 115VAC, 50/60Hz.

#### Output:

- Sixteen (16) fuse or PTC protected outputs.
- 24VAC or 28VAC supply current.
- Outputs are rated @ 3.5A (fused) or 2.5A (PTC).
- Surge suppression.

#### Features:

- AC power LED.
- Power ON/OFF switch.
- Spare fuses provided.  
(all models w/primary and/or secondary fuses).
- Unit maintains camera synchronization.

#### Features (cont'd):

- Ease of installation saves time & eliminates costly labor.
- Spare fuses included (on fuse protected models).

#### Enclosure Dimensions:

##### ALTV2416 and ALTV2416CB:

8.5" x 7.5" x 3.5"  
(215.9mm x 190.5mm x 88.9mm).

##### ALTV2416350, ALTV2416350CB, ALTV2416600, and ALTV2416600CB:

13.5" x 13" x 3.25"  
(342.9mm x 330.2mm x 82.6mm).

## Installation Instructions:

1. Mount unit in the desired location. Mark and predrill holes in the wall to line up with the top two keyholes in the enclosure. Install two upper fasteners and screws in the wall with the screw heads protruding. Place the enclosure's upper keyholes over the two upper screws, level and secure. Mark the position of the lower two holes. Remove the enclosure. Drill the lower holes and install three fasteners. Place the enclosure's upper keyholes over the two upper screws. Install the two lower screws and make sure to tighten all screws (*Enclosure Dimensions, pg. 7-8*). Secure enclosure to earth ground.
2. Slide switch on PD board to OFF position for models ALTV2416 and ALTV2416CB (*Fig. 1, pg. 4*). Turn OFF main switch on all other models (*Figs. 2-4, pgs. 5-7*).
3. All units are factory set for 24VAC operation.  
For 28VAC operation, adjust unit prior to mounting and applying power as follows:  
Change the wire position so that the black wire [28V] is connected to the terminal marked [P] and the yellow wire [24V] is connected to the terminal marked [S].
4. Connect AC power to the black and white flying lead of the transformer(s) (*Figs. 1-3, pgs. 4-6*). Use 18 AWG or larger for all power connections.
5. Measure output voltage before connecting devices. This helps avoiding potential damage.  
Terminals marked [1P - 8P] are positive of the same polarity.  
**CAUTION: Determine the maximum operating voltage of the equipment being powered before adjusting the output voltage.**
6. Connect devices to terminals marked [1P - 1N] through [8P - 8N] on PD8/PD8CB board, carefully observing polarity.
7. Slide switch on PD board to ON position for models ALTV2416, and ALTV2416CB (*Fig. 1, pg. 4*). Turn main switch on all other models to the "RESET" (ON) position (*Figs. 2-3, pgs. 5-6*).
8. Green LED will illuminate when the unit is powered.
9. Upon completion of the wiring, secure enclosure door with screws (supplied).

**Caution: Equipment to be installed / serviced by authorized / trained personnel only.  
Shut branch circuit power before installing / servicing equipment.**

**WARNING: To reduce the risk of fire or electric shock, do not expose the unit to rain or moisture. This installation should be made by qualified service personnel and should conform to the National Electrical Code and all local codes.**

## Terminal Identification:

### PD8/PD8CB - Distribution Module

1P - 8P	AC output.
1N - 8N	AC output.

### PD16W/PD16WCB - Distribution Module

1P - 16P	AC output.
1N - 16N	AC output.



The lightning flash with arrowhead symbol within an equilateral triangle is intended to alert the user to the presence of an insulated DANGEROUS VOLTAGE within the product's enclosure that may be of sufficient magnitude to constitute an electric shock.



The exclamation point within an equilateral triangle is intended to alert the user to the presence of important operating and maintenance (servicing) instructions in the literature accompanying the appliance.



**CAUTION**  
**RISK OF ELECTRIC SHOCK**  
**DO NOT OPEN**



**CAUTION:** To reduce the risk of electric shock do not open enclosure. There are no user serviceable parts inside. Refer servicing to qualified service personnel.

Fig. 1 - ALTV2416 and ALTV2416CB

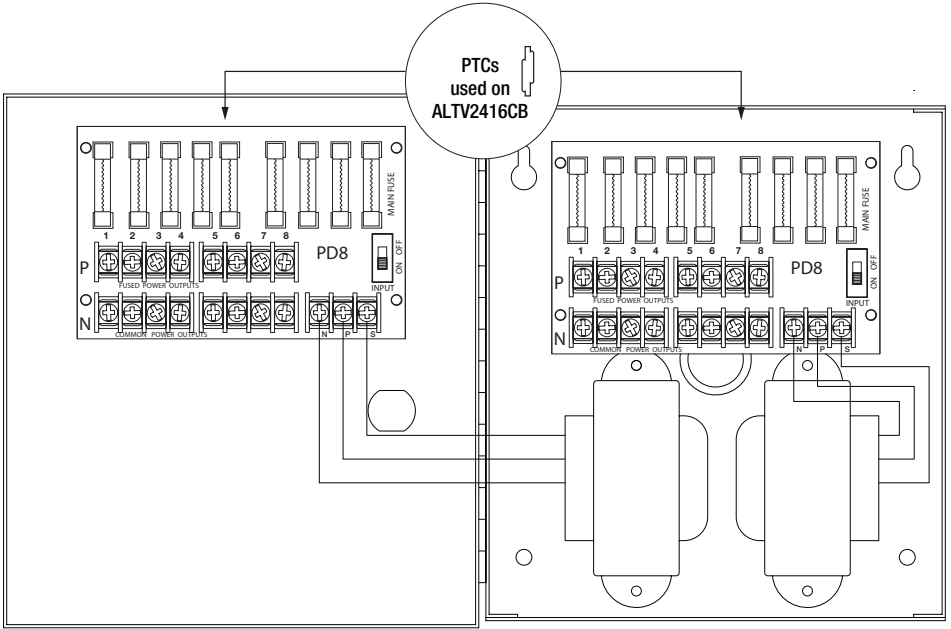

**Voltage Selection Configuration**

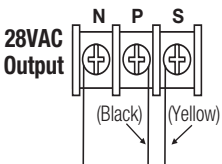
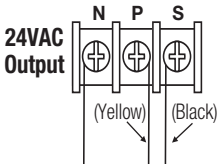
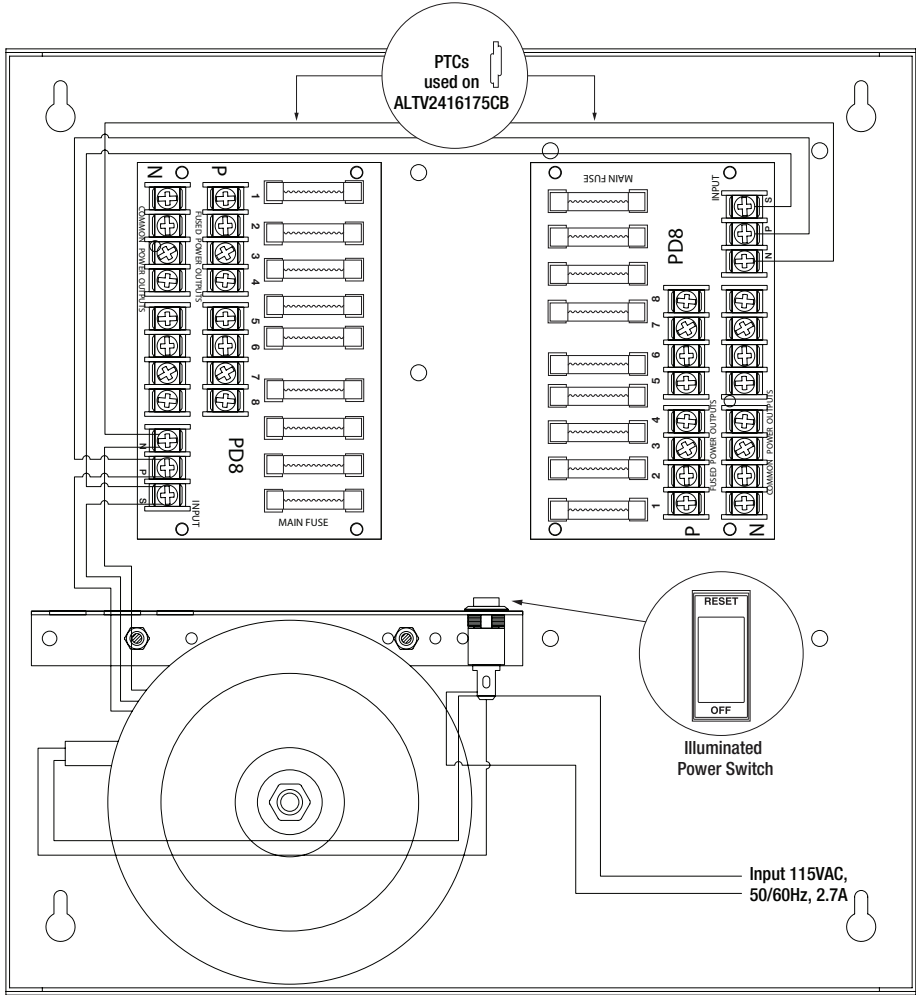

Fig. 2 - ALTV2416350 and ALTV2416350CB



**Voltage Selection Configuration**

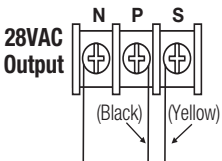
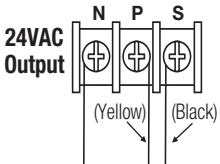
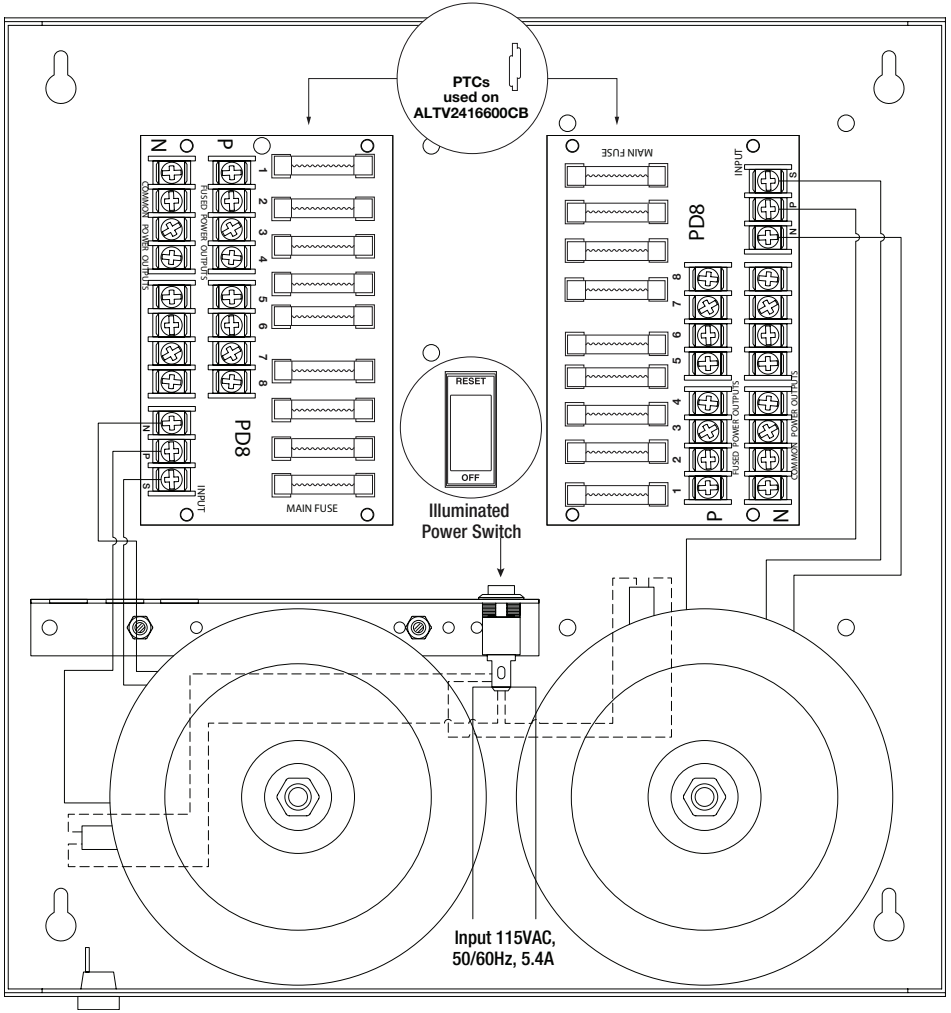
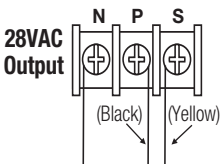
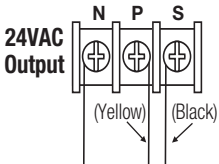

Fig. 3 - ALTV2416600 and ALTV2416600CB



**Voltage Selection Configuration**



# Enclosure Dimensions (H x W x D) for:

## • ALTV2416 • ALTV2416CB

8.5" x 7.5" x 3.5" (215.9mm x 190.5mm x 88.9mm)

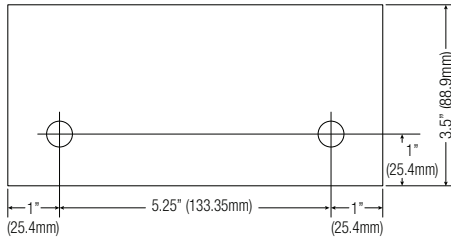
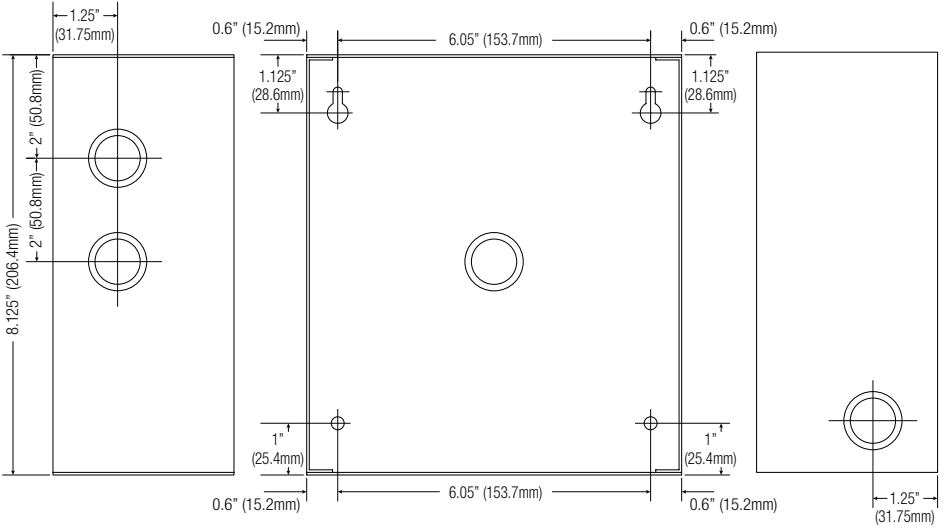
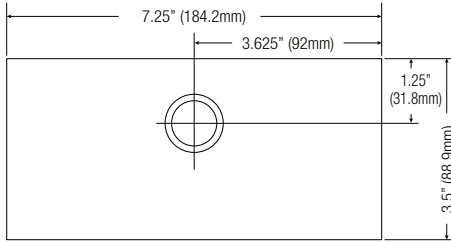

# Enclosure Dimensions (H x W x D) for:

• ALTV2416600 • ALTV2416600CB

13.5" x 13" x 3.25" (342.9mm x 330.2mm x 82.6mm)

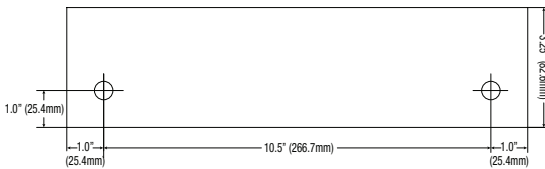
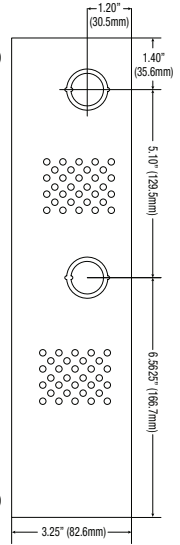
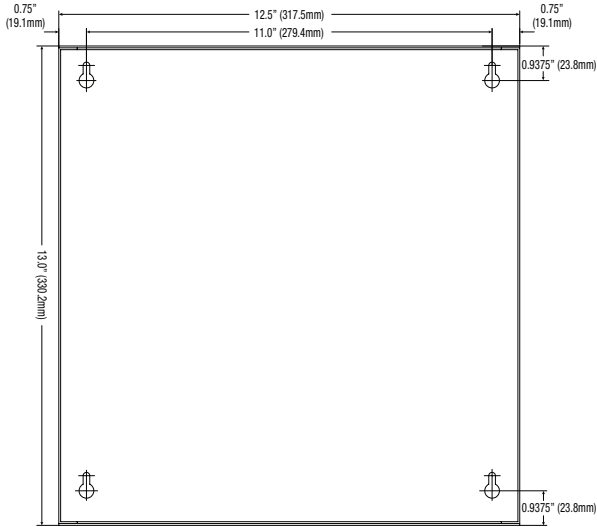
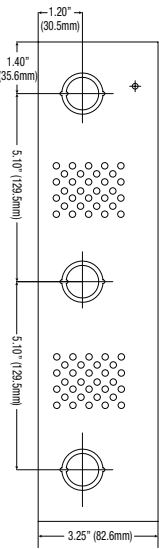
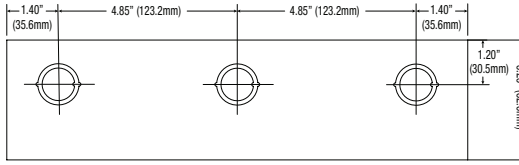

Altronix is not responsible for any typographical errors.

140 58th Street, Brooklyn, New York 11220 USA | 718-567-8181 | fax: 718-567-9056  
 website: [www.altronix.com](http://www.altronix.com) | e-mail: [info@altronix.com](mailto:info@altronix.com) | Lifetime Warranty  
 IALTV2416 Series J27U

