

# **ALTV248UL3 Series CCTV Power Supplies**

## **Installation Guide**

### **Models Include:**

#### **ALTV248UL3**

- 24VAC @ 3.5A (85VA)  
or 28VAC @ 3A (85VA).
- Eight (8) Fuse Protected Outputs.
- Factory installed 3-wire line cord.

#### **ALTV248175UL3**

- 24VAC @ 7A (175VA)  
or 28VAC @ 6.25A (175VA).
- Eight (8) Fuse Protected Outputs.
- Factory installed 3-wire line cord.

#### **ALTV248300UL3**

- 24VAC @ 12.5A (300VA)  
or 28VAC @ 10A (280VA).
- Eight (8) Fuse Protected Outputs.
- Factory installed 3-wire line cord.

#### **ALTV248300ULM3**

- 24VAC @ 12.5A (300VA)  
or 28VAC @ 10A (280VA).
- Eight (8) Fuse Protected Outputs.
- Factory installed 3-wire line cord.

#### **ALTV248600UL3**

- 24VAC @ 25A (600VA)  
or 28VAC @ 20A (560VA).
- Eight (8) Fuse Protected Outputs.
- Factory installed 3-wire line cord.

#### **ALTV248ULCB3**

- 24VAC @ 3.5A (85VA)  
or 28VAC @ 3A (85VA).
- Eight (8) PTC Protected Outputs.
- Factory installed 3-wire line cord.

#### **ALTV248175ULCB3**

- 24VAC @ 7A (175VA)  
or 28VAC @ 6.25A (175VA).
- Eight (8) PTC Protected Outputs.
- Factory installed 3-wire line cord.

#### **ALTV248300ULCB3**

- 24VAC @ 12.5A (300VA)  
or 28VAC @ 10A (280VA).
- Eight (8) PTC Protected Outputs.
- Factory installed 3-wire line cord.

#### **ALTV248300ULCBM3**

- 24VAC @ 12.5A (300VA)  
or 28VAC @ 10A (280VA).
- Eight (8) PTC Protected Outputs.
- Factory installed 3-wire line cord.

#### **ALTV248600ULCB3**

- 24VAC @ 25A (600VA)  
or 28VAC @ 20A (560VA).
- Eight (8) PTC Protected Outputs.
- Factory installed 3-wire line cord.



## Overview:

Altronix ALTV248UL3 Series CCTV Power Supplies provide 24VAC or 28VAC distributed via eight (8) fuse or PTC protected outputs for powering CCTV cameras, heaters and other video accessories.

### Eight (8) Output ALTV248UL3 Reference Chart:

Altronix Model Number	Output Voltage	Total Output Current (Power)	Number of Outputs	PTC Protected auto-resettable Outputs (Class 2 Rated power-limited for Dry locations, Class 3 for Wet locations)	Fuse Protected Class 1 Outputs	Individual Output Current (max per output, not to exceed total output current)	Fuse Ratings	Main Fuse Ratings	Primary In-line Fuse Ratings	115VAC 60Hz Input Current	Agency Listings
ALTV248UL3	24VAC	3.5A	8	-	✓	3.5A	3.5A	5A/250V	3.5A/250V	0.9A	
	28VAC	3A									
ALTV248ULCB3	24VAC	3.5A	8	✓	-	2.5A	-	5A/250V	3.5A/250V	0.9A	
	28VAC	3A									
ALTV248175UL3	24VAC	7A	8	-	✓	3.5A	3.5A	10A/250V	3.5A/250V	1.76A	
	28VAC	6.25A									
ALTV248175ULCB3	24VAC	7A	8	✓	-	2.5A	-	10A/250V	3.5A/250V	1.76A	
	28VAC	6.25A									
ALTV248300UL3	24VAC	12.5A	8	-	✓	3.5A	3.5A	15A/32V	-	2.7A	
	28VAC	10A									
ALTV248300ULCB3	24VAC	12.5A	8	✓	-	2.5A	-	15A/32V	-	2.7A	
	28VAC	10A									
ALTV248300ULM3	24VAC	12.5A	8	-	✓	3.5A	3.5A	15A/32V	-	2.7A	
	28VAC	10A									
ALTV248300ULCBM3	24VAC	12.5A	8	✓	-	2.5A	-	15A/32V	-	2.7A	
	28VAC	10A									
ALTV248600UL3	24VAC	25A	8	-	✓	3.5A	3.5A	15A/32V	-	5.4A	
	28VAC	20A									
ALTV248600ULCB3	24VAC	25A	8	✓	-	2.5A	-	15A/32V	-	5.4A	
	28VAC	20A									

## Specifications:

### Agency Listings:

- UL Listed for Commercial CCTV Equipment (UL 2044).
- CUL Listed - CSA Standard C22.2 No.1-98, Audio, Video and Similar Equipment.
- CE European Conformity.

### Input:

- 115VAC, 50/60Hz.

### Output:

- Eight (8) fuse or PTC protected outputs.
- 24VAC or 28VAC output
- Outputs are rated @ 3.5A (fused) or 2.5A (PTC).
- Surge suppression.

### Features:

- AC power LED indicator.
- Power ON/OFF switch (ALTV248UL3, ALTV248ULCB3).

### Features (cont'd):

- Illuminated power disconnect circuit breaker with manual reset (all other models).
- Unit maintains camera synchronization.
- Ease of installation saves time and eliminates costly labor.
- Spare fuses included (on fuse protected models).

### Enclosure Dimensions (H x W x D):

- **ALTV248UL3 and ALTV248ULCB3:**  
8.5" x 7.5" x 3.5" (215.9mm x 190.5mm x 88.9mm)
- **ALTV248300ULM3 and ALTV248300ULCBM3:**  
8.5" x 7.5" x 3.75" (215.9mm x 190.5mm x 97.9mm)
- **ALTV248175UL3, ALTV248175ULCB3, ALTV248300UL3, and ALTV248300ULCB3:**  
12" x 7.5" x 4.5" (304.8mm x 190.5mm x 114.3mm)
- **ALTV248600UL3 and ALTV248600ULCB3:**  
13.5" x 13" x 3.25" (342.9mm x 330.2mm x 82.6mm)

## **Installation Instructions:**

Wiring methods shall be in accordance with the National Electrical Code/NFPA 70/NFPA 72/ANSI, and with all local codes and authorities having jurisdiction. Product is intended for indoor use only.

1. Mount unit in a desired location. Mark and predrill holes in the wall to line up with the top two keyholes in the enclosure. Install two upper fasteners and screws in the wall with the screw heads protruding. Place the enclosure's upper keyholes over the two upper screws, level and secure. Mark the position of the lower two holes. Remove the enclosure. Drill the lower holes and install the three fasteners. Place the enclosure's upper keyholes over the two upper screws. Install the two lower screws and make sure to tighten all screws (*Enclosure Dimensions, pgs. 14-16*). Secure enclosure to earth ground.
2. Set power switch on power distribution board marked [PD] to OFF position for models ALTV248UL3 or ALTV248ULCB3 (*Figs. 1a, 2a, pgs. 4, 5*). Set power disconnect circuit breaker to OFF position for all other models (*Figs. 3a-10a, pgs. 6-13*).
3. All units are factory set for 24VAC operation.  
For 28VAC operation adjust unit prior to mounting and applying power as follows:  
Change the wire position so that the wire marked [28V] is connected to the terminal marked [P] and the wire marked [24V] is connected to the terminal marked [S].  
**Note: ALTV248ULCB3 set for 28VAC operation is not Class 2 Rated, not power-limited.**
4. Connect AC power to the black and white flying leads of the transformer(s) (*Figs. 1-10, pgs. 4-13*), secure green lead to earth ground. Use 18 AWG or larger for all power connections.  
**Keep power-limited (PTC protected outputs only) wiring separate from non power-limited wiring. Minimum 0.25" spacing must be provided. Use separate knockouts.**
5. Set power switch on power distribution board marked [PD] to ON position for models ALTV248UL3 or ALTV248ULCB3 (*Figs. 1a, 2a, pgs. 4, 5*). Set power disconnect circuit breaker to RESET (ON) position for all other models (*Figs. 3a - 10a, pgs. 6-13*).
6. Measure output voltage before connecting devices. This helps avoid potential damage.  
Terminals marked [1P] - [8P] are of the same polarity.  
**CAUTION:** Determine the maximum operating voltage of the equipment being powered before adjusting the output voltage.
7. Set power switch on power distribution board marked [PD] to OFF position for models ALTV248UL3 or ALTV248ULCB3 (*Figs. 1a, 2a, pgs. 4, 5*). Set power disconnect circuit breaker to OFF position for all other models (*Figs. 3a - 10a, pgs. 6-10*).
8. Connect devices to terminals marked [1P] - [1N] through [4P] - [4N] on PD4/PD4CB board (*Figs. 9, 10, pgs. 12, 13*) or terminals marked [1P] - [1N] through [8P] - [8N] on PD8/PD8CB board (*Figs. 1-8, pgs. 4-12*), carefully observing polarity.
9. Set power switch on power distribution board marked [PD] to ON position for models ALTV248UL3 or ALTV248ULCB3 (*Figs. 1a, 2a, pgs. 4, 5*). Set power disconnect circuit breaker to RESET (ON) position for all other models (*Figs. 3a - 10a, pgs. 6-13*).
10. Green LED will illuminate when power is present.
11. Upon completion of wiring, secure enclosure door with screws (supplied).  
Installation of cam lock is optional.  
**Caution: Equipment to be installed/serviced by authorized/trained personnel only.  
Shut branch circuit power before installing/servicing equipment.**

**WARNING: To reduce the risk of fire or electric shock, do not expose the unit to rain or moisture. This installation should be made by qualified service personnel and should conform to the National Electrical Code and all local codes. Use 75°C or higher rated UL insulated wiring for connecting the unit to the mains. Replace fuses with the same type and rating (refer to Eight (8) Output ALTV248UL3 Reference Chart, pg. 2).**

## **Terminal Identification:**

### **PD4/PD4CB - Distribution Module**

1P - 4P	AC output.
1N - 4N	AC output.

### **PD8/PD8CB - Distribution Module**

1P - 8P	AC output.
1N - 8N	AC output.



The lightning flash with arrowhead symbol within an equilateral triangle is intended to alert the user to the presence of an insulated **DANGEROUS VOLTAGE** within the product's enclosure that may be of sufficient magnitude to constitute an electric shock.



The exclamation point within an equilateral triangle is intended to alert the user to the presence of important operating and maintenance (servicing) instructions in the literature accompanying the appliance.



**CAUTION**  
RISK OF ELECTRIC SHOCK  
DO NOT OPEN



**CAUTION:** To reduce the risk of electric shock do not open enclosure. There are no user serviceable parts inside. Refer servicing to qualified service personnel.

Fig. 1 - ALTV248UL3

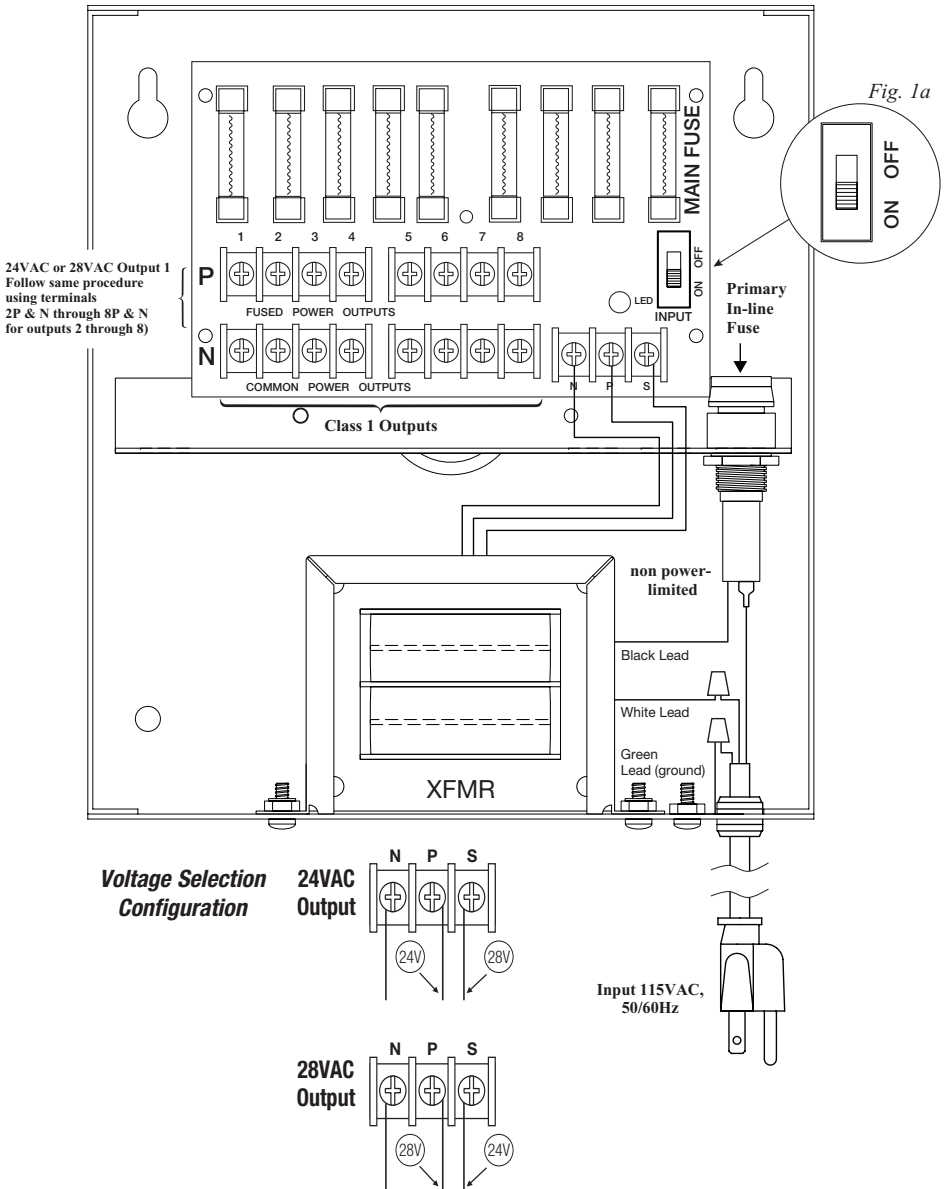
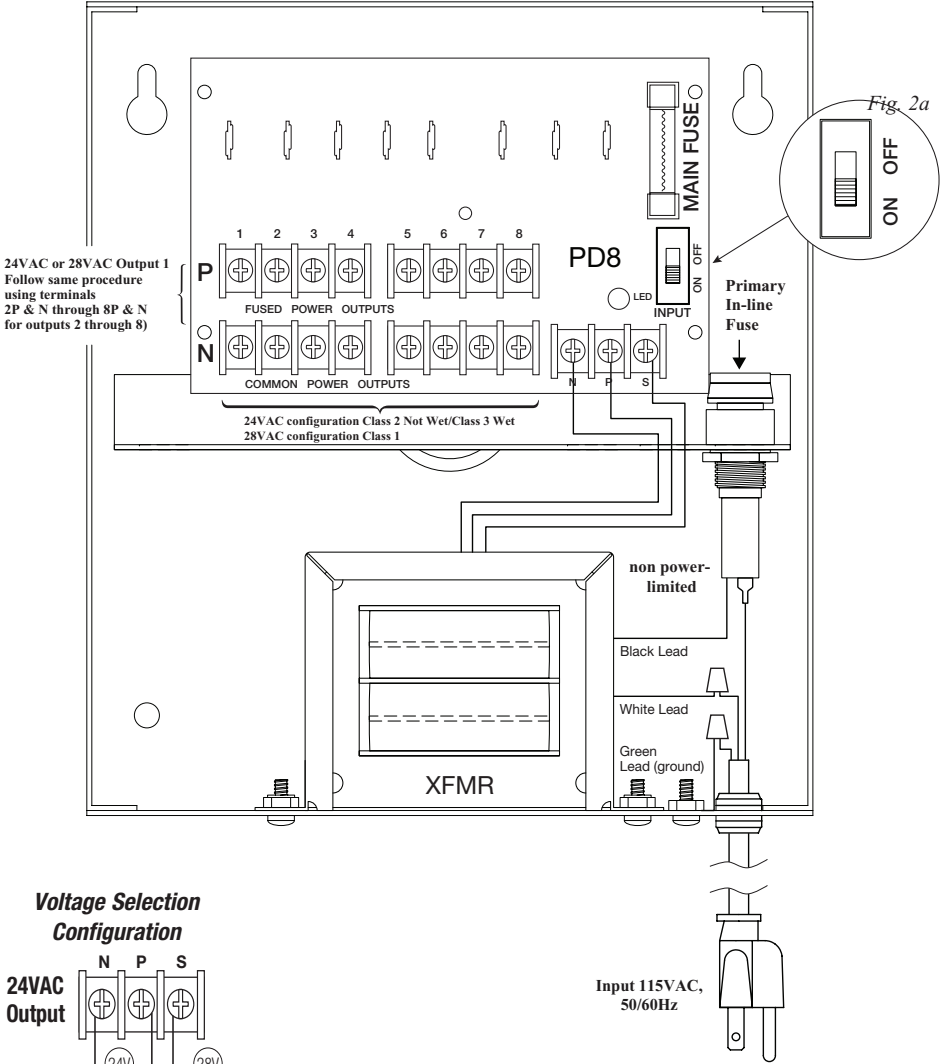

Fig. 2 - ALTV248ULCB3



**Voltage Selection Configuration**

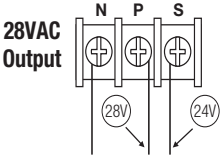
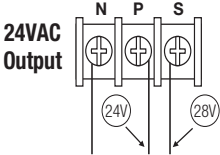

Fig. 3 - ALTV248175UL3

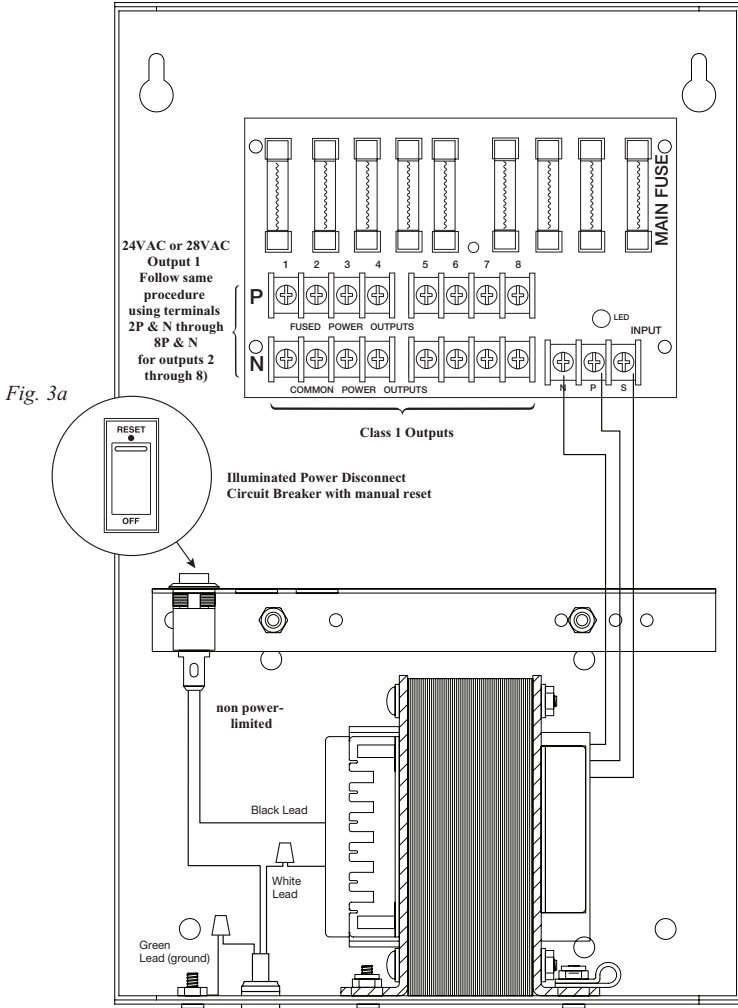
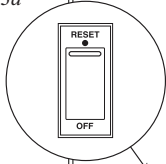
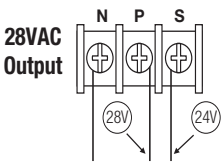
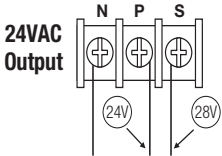

Fig. 3a



**Voltage Selection Configuration**



Input 115VAC, 50/60Hz

Fig. 4 - ALTV248175ULCB3

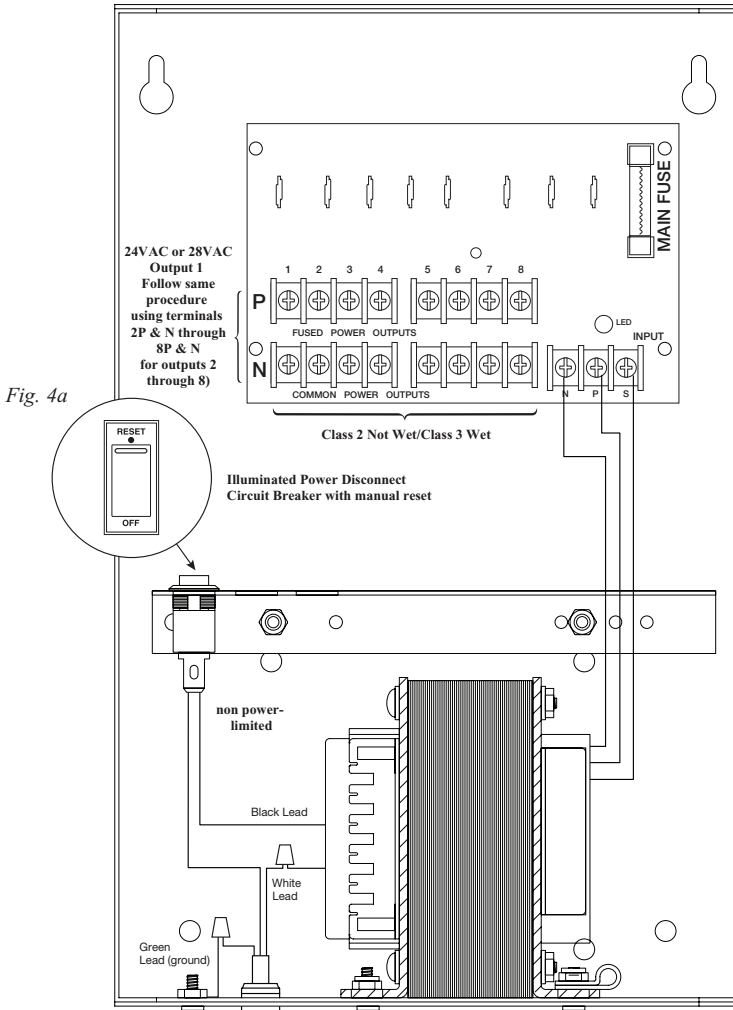

**Voltage Selection  
Configuration**

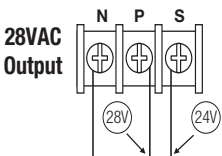
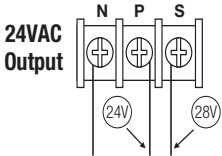

Input 115VAC,  
50/60Hz

Fig. 5 - ALTV248300UL3

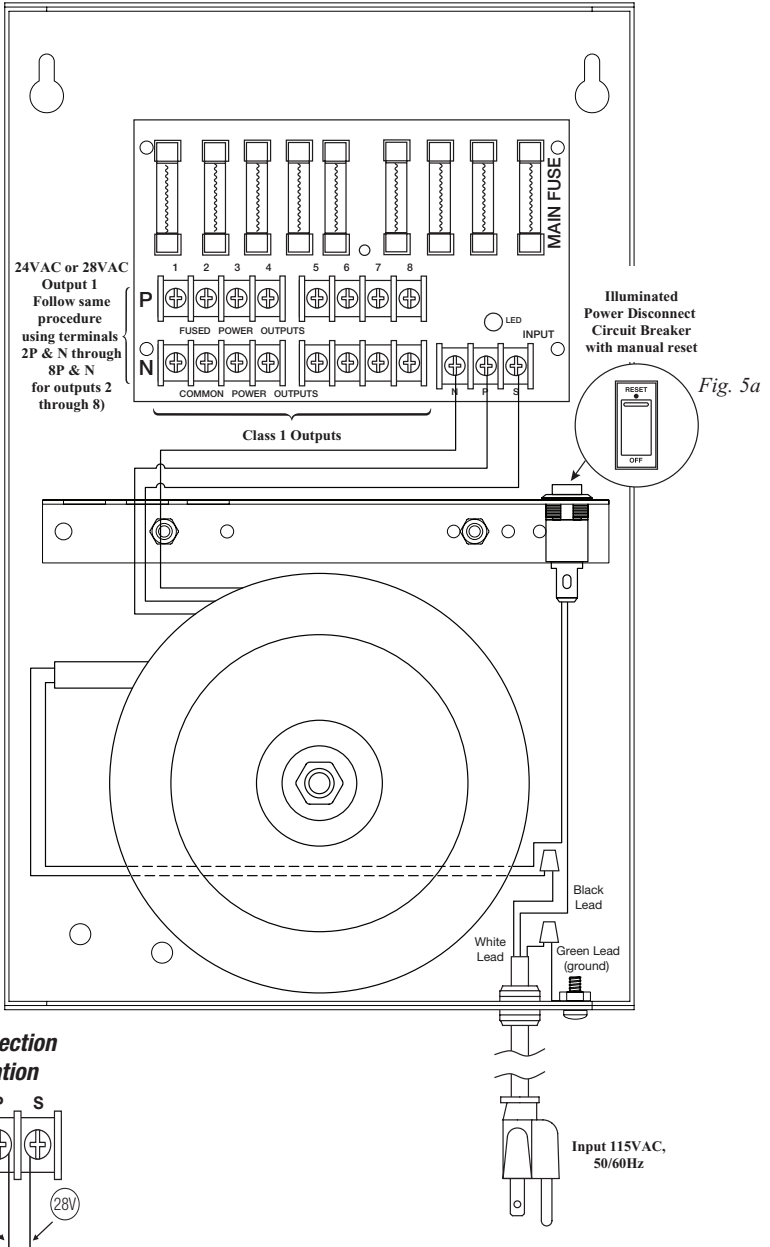



Fig. 6 - ALTV248300ULCB3

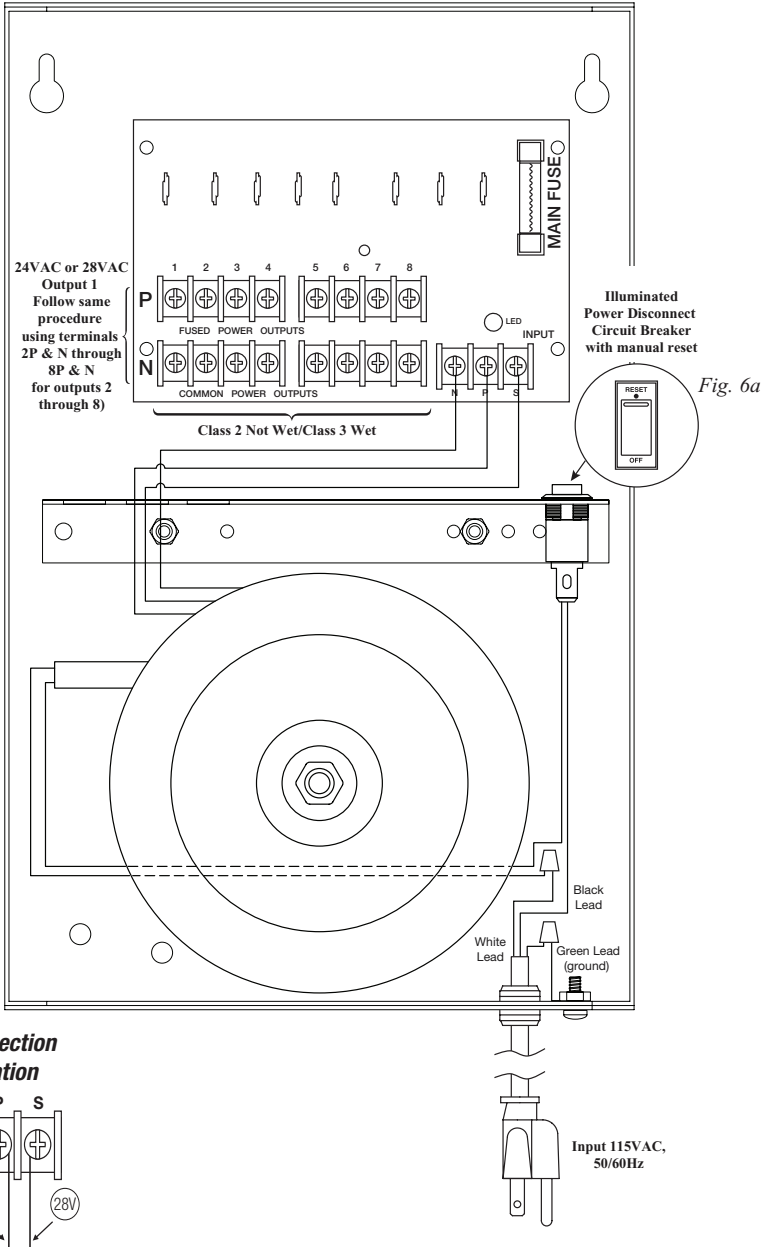
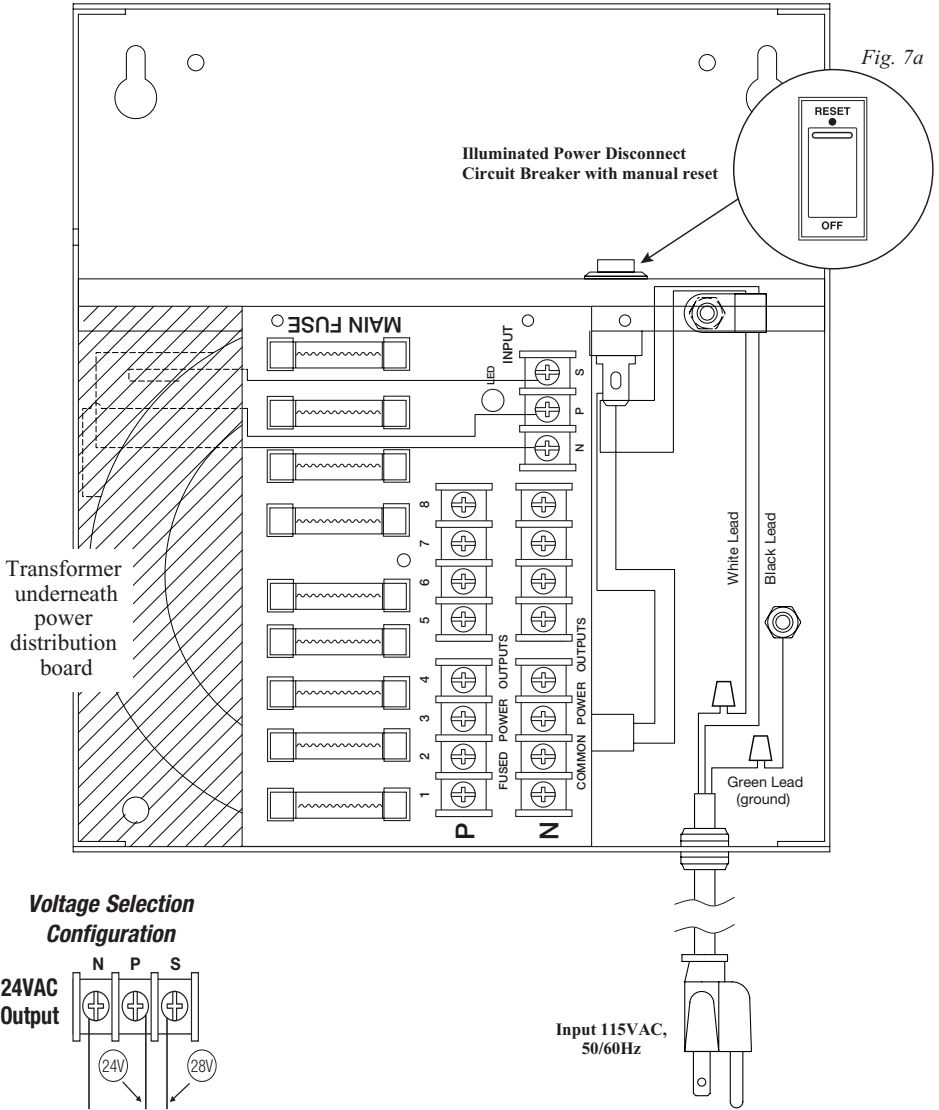

Fig. 6a

Fig. 7 - ALTV248300ULM3



**Voltage Selection Configuration**

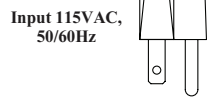
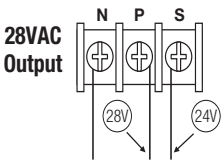
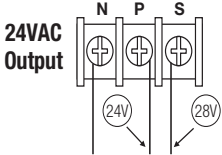
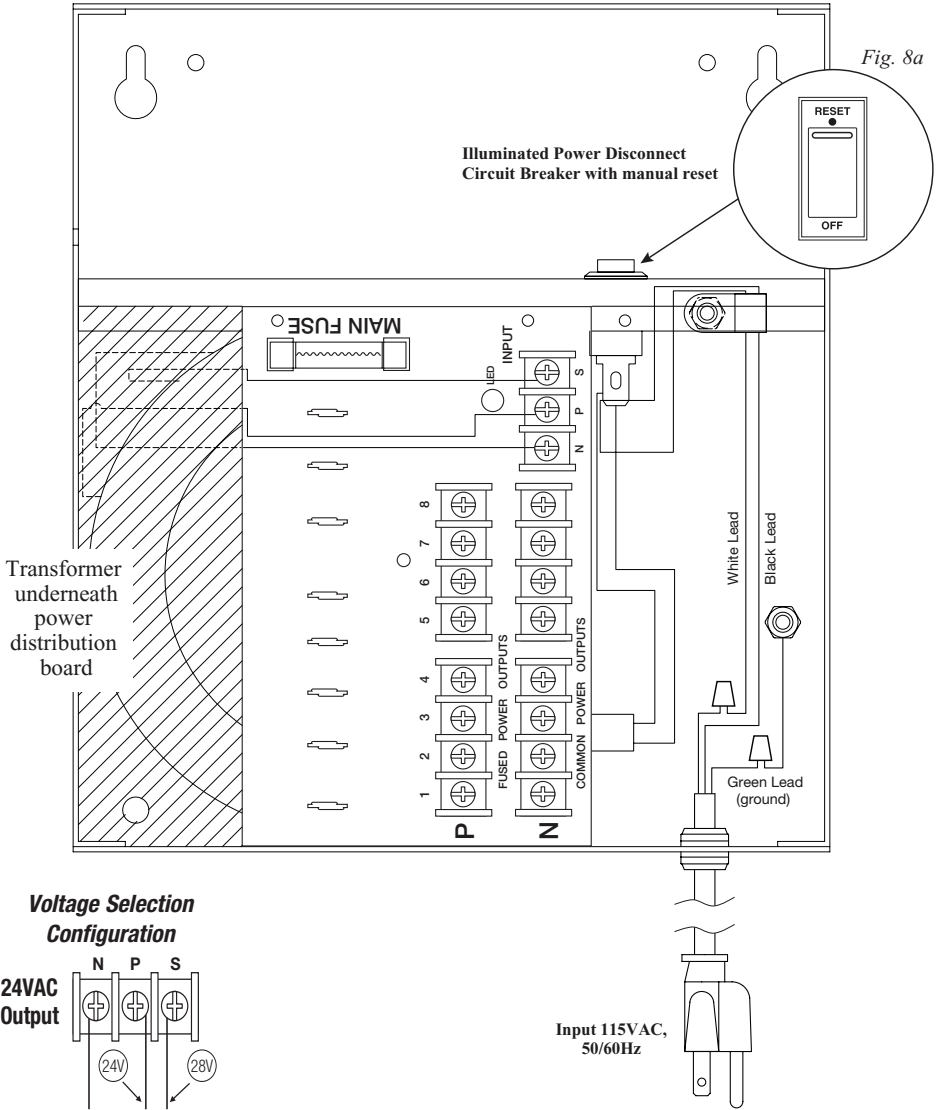

Fig. 8 - ALTV248300ULCBM3



**Voltage Selection Configuration**

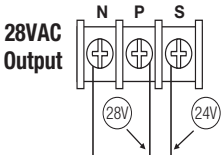
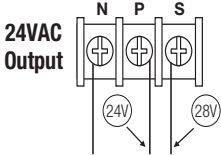
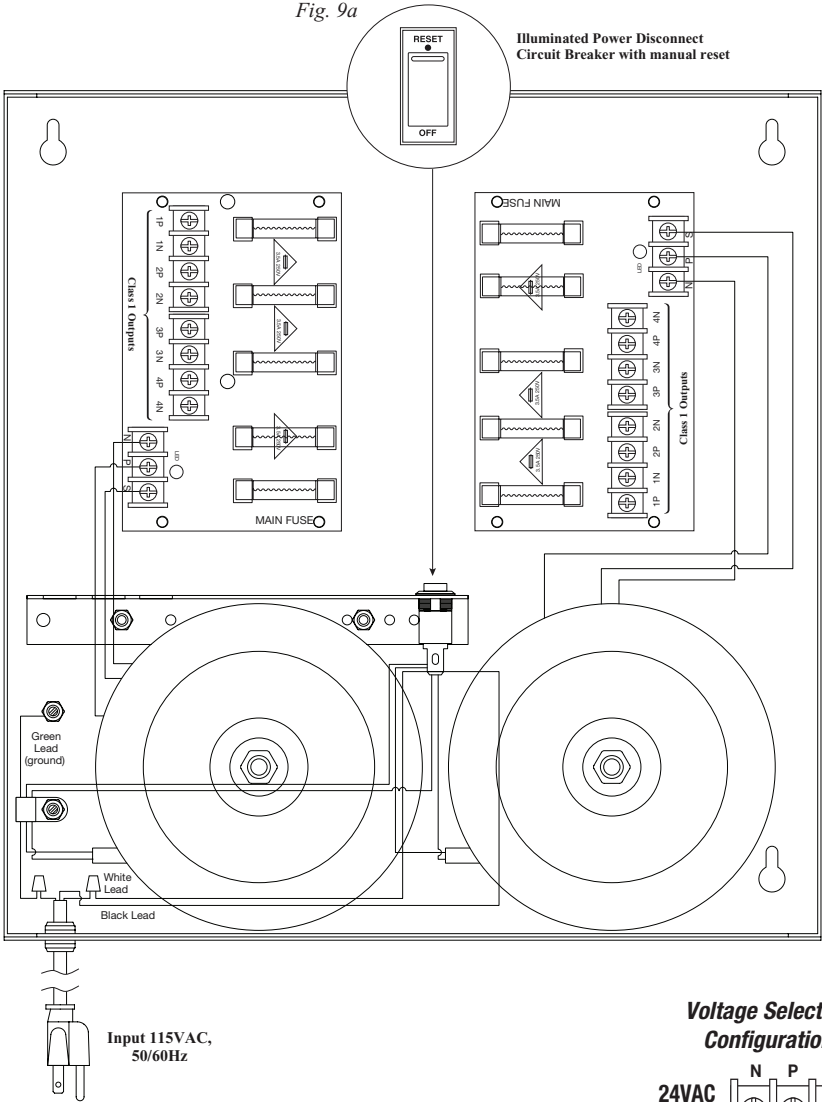

Fig. 9 - ALTV248600UL3

Fig. 9a



**Voltage Selection Configuration**

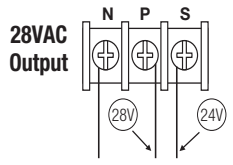
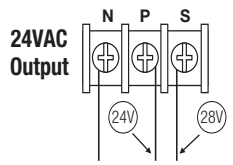
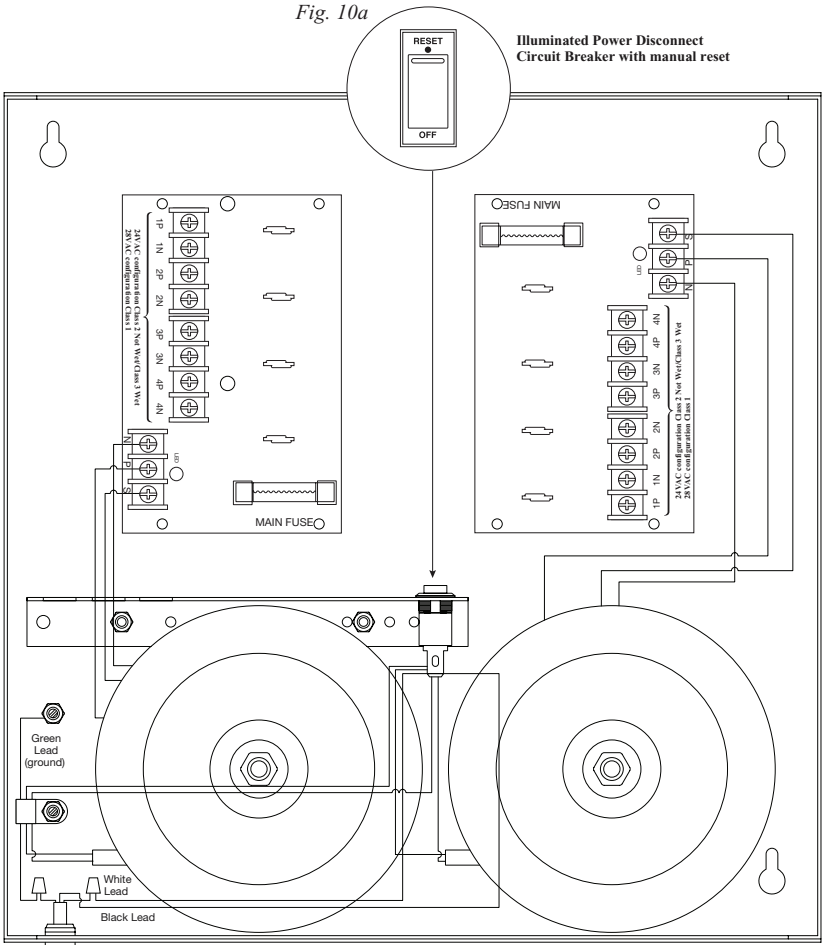

Fig. 10 - ALTV248600ULCB3

Fig. 10a



Illuminated Power Disconnect  
Circuit Breaker with manual reset

Input 115VAC,  
50/60Hz

**Voltage Selection  
Configuration**

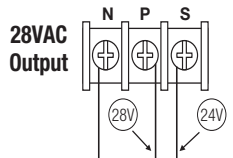
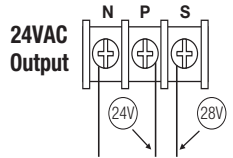

**Enclosure Dimensions (H x W x D):**

• **ALTV248UL3**

• **ALTV248ULCB3**

8.5" x 7.5" x 3.5"

(215.9mm x 190.5mm x 88.9mm)

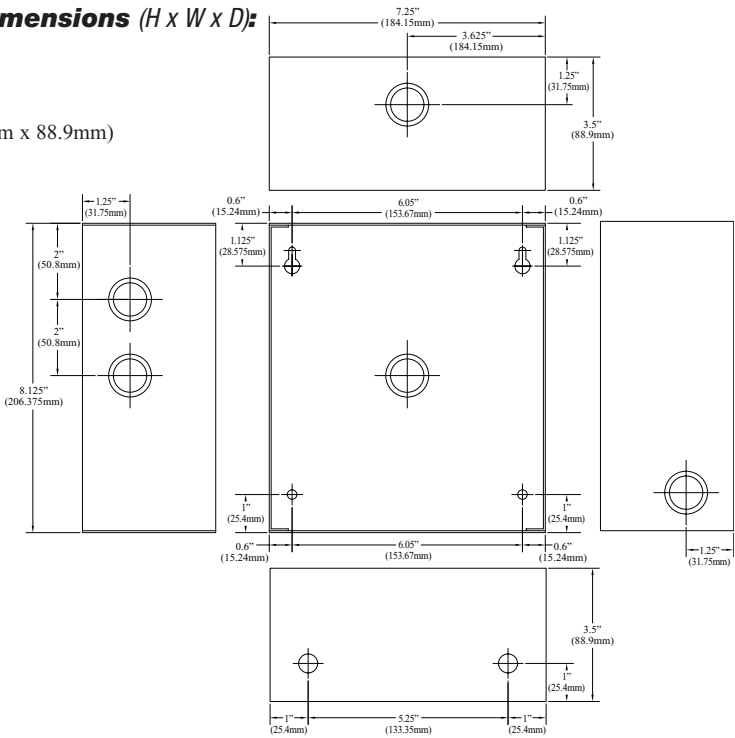

**Enclosure Dimensions (H x W x D):**

• **ALTV248300ULM3**

• **ALTV248300ULCBM3**

8.5" x 7.5" x 3.75"

(215.9mm x 190.5mm x 97.9mm)

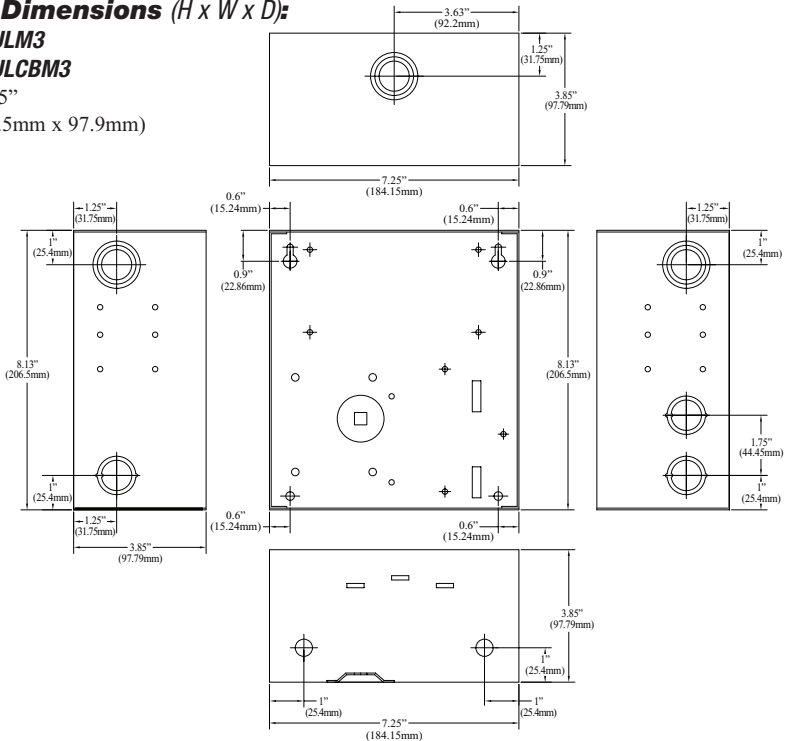

# Enclosure Dimensions (H x W x D):

• ALTV248175UL3 • ALTV248175ULCB3 • ALTV248300UL3 • ALTV248300ULCB3

12" x 7.5" x 4.5" (304.8mm x 190.5mm x 114.3mm)

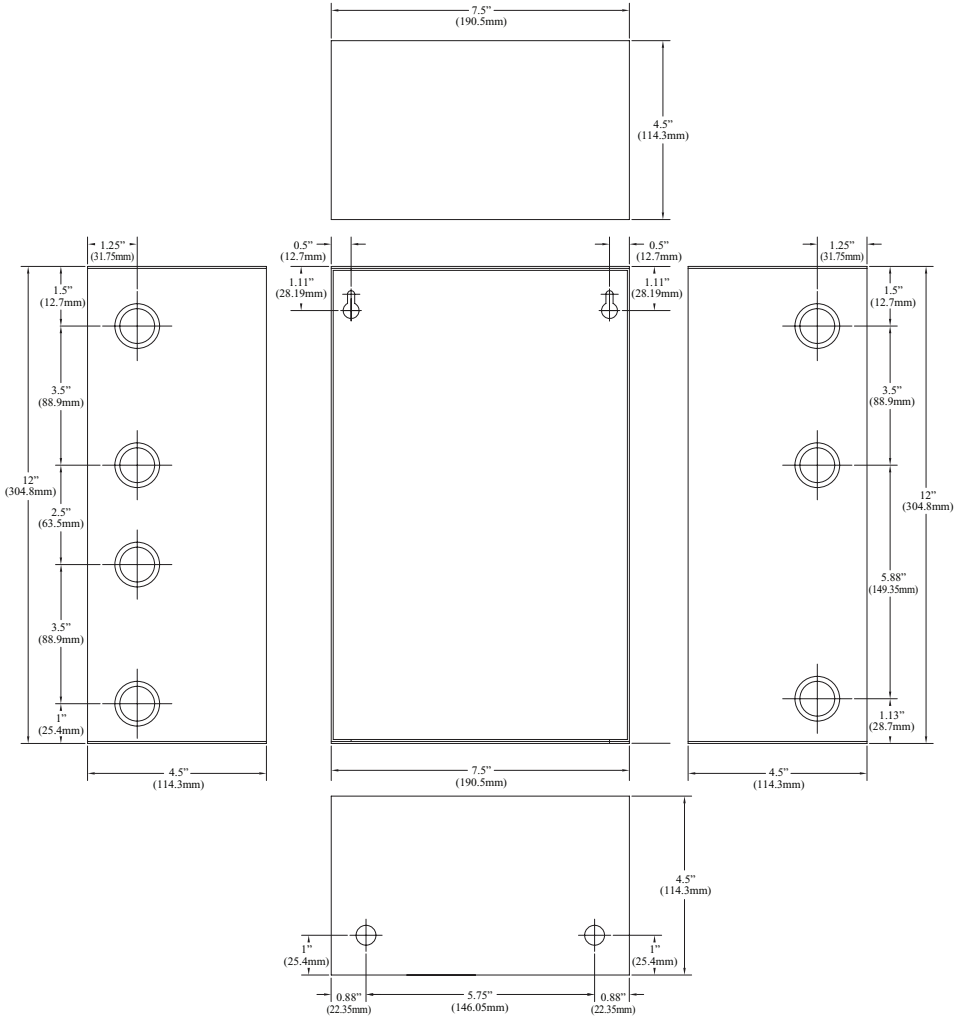

# Enclosure Dimensions (H x W x D) for:

• ALTV24860UL3 • ALTV24860ULCB3

13.5" x 13" x 3.25" (342.9mm x 330.2mm x 82.6mm)

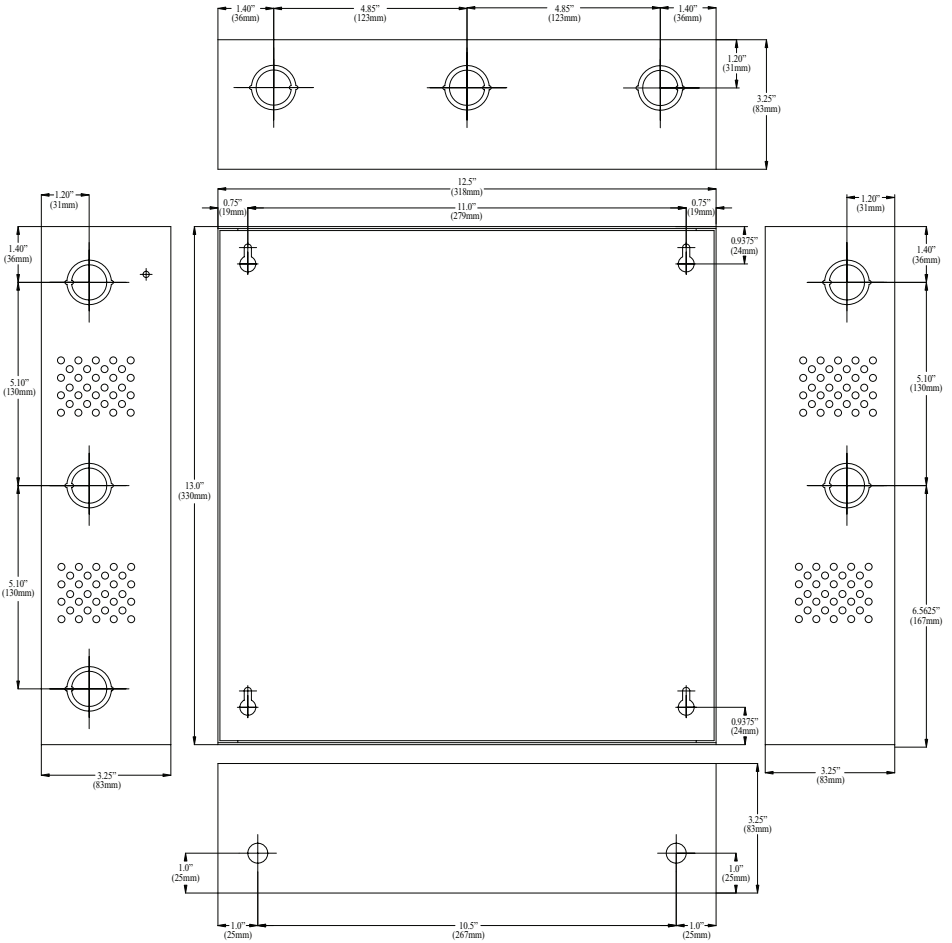

Altronix is not responsible for any typographical errors.

140 58th Street, Brooklyn, New York 11220 USA | phone: 718-567-8181 | fax: 718-567-9056  
website: [www.altronix.com](http://www.altronix.com) | e-mail: [info@altronix.com](mailto:info@altronix.com) | Lifetime Warranty | Made in U.S.A.

HALTV248UL3 Series

D03R

- 16 -



MEMBER  
ALTV248UL3 Series