



VIP User Guide

Incorporating:

- VIP-UHD-TX
- VIP-UHD-RX
- VIP-UHD-CTRL

Contents

Introduction	03	RS-232 (Serial) Routing	50
VIP-UHD Overview - Features	03	IR, RS-232 & Telnet Commands	51 - 55
Supporting Documentation	04	Status Feedback Samples	56 - 57
HDMI over IP Network	04	Troubleshooting the VIP-UHD-CTRL	58
Panel Descriptions - VIP-UHD-TX	05	Manual Configuration of VIP-UHD	59 - 60
Panel Descriptions - VIP-UHD-RX	06	EDID and Scaler Settings Overview	61
Panel Descriptions - VIP-UHD-CTRL	07	Accessing the VIP-UHD Web-GUI	62
Schematics	08 - 12	VIP-UHD Web-GUI Overview	63 - 67
Configuration of a VIP System	13 - 14	PC Settings - enabling TFTP & Telnet	68
VIP-UHD-CTRL Features	15	Setting a Fixed IP Address	69 - 71
VIP-UHD-CTRL Control Ports	16 - 17	Integrator Notes	72 - 73
VIP-UHD-CTRL Web-GUI Guide - Sign In	18		
New Project Setup Wizard	19 - 23		
Web-GUI - Menu Overview	24		
Web-GUI - Drag & Drop Control	25		
Web-GUI - Video Wall Control	26		
Web-GUI - Preview	27		
Web-GUI - Project Summary	28		
Web-GUI - Transmitters	29 - 31		
Web-GUI - Receivers	32 - 33		
Web-GUI - Fixed Signal Routing	34 - 36		
Web-GUI - Video Wall Configuration	37 - 42		
Web-GUI - Users	43 - 44		
Web-GUI - Settings	45 - 46		
Web-GUI - Update Firmware	47 - 49		
Web-GUI - Update Password (Admin)	49		

Introduction

The RTI VIP-UHD distribution platform allows virtually latency free (1 frame) distribution of HDMI video over a 1Gb Network switch. VIP-UHD is an industry leading 4K HDCP 2.2 HDMI distribution system that uses visually lossless compression technology, delivering HDMI, Bi-directional IR, RS-232, USB/KVM and CEC up to lengths of 328ft/100m over standard network architecture. The VIP-UHD units can be powered via PoE from a PoE Network switch or locally should the switch not support PoE.

With multiple configuration options available the VIP-UHD solution is ideal for both commercial and residential installations. Furthermore the VIP-UHD-CTRL with in-built web-GUI, and easy-to-follow switch configuration guides simplifies VIP-UHD product installation, negating the need for an understanding of complex network infrastructures.

This User Guide incorporates all elements of the VIP system, from hardware to software.

Hardware:

- VIP-UHD Transmitter and Receiver
- VIP-UHD-CTRL - Advanced Control Module

Software:

- VIP-UHD-CTRL Web-GUI
- VIP-UHD-TX/RX Web-GUI

VIP-UHD Overview - Features

- Advanced UHD video over 1Gb Network with virtually unlimited system size
- Extends HDMI over a LAN network architecture - compatible with common brands of L3 managed network switches
- Supports up to 4K HDR UHD video input (3840 x 2160 @30Hz 4:4:4, 4096 x 2160 @24Hz 4:4:4, and 4K @60Hz 4:2:0)
- Supports all known HDMI audio formats including Dolby TrueHD, Atmos and DTS-HD Master Audio transmission
- Features 4 operational modes:
 - Matrix distribution (requires 1Gb network switch)
 - Video Wall (requires 1Gb network switch)
 - One-to-one HDMI extender (no network switch required)
 - One-to-many HDMI extender (no network switch required)
- HDCP 2.2 compliant
- Advanced EDID management
- Video up-scaling and down-scaling
- Analog L/R audio embedding and de-embedding on VIP-UHD Transmitter
- Analog L/R audio de-embedding on VIP-UHD Receiver
- Fully routable: Video, Audio, bi-directional IR, RS-232, USB / KVM and CEC
- PoE (Power over Ethernet) to power RTI VIP products from a PoE switch
- Simple configuration via web-GUI through the VIP-UHD-CTRL
- RS-232, IR and Telnet/IP integration for control of the VIP system using VIP-UHD-CTRL

Supporting Documentation

Individual parts of this User Guide, and additional supporting documentation are available to download from the RTI Dealer Site. This includes:

- Product Specifications / Data sheets
- VIP-UHD Network Switch Overview
- VIP-UHD Network Switch Guides

HDMI over IP Network

The RTI VIP system distributes HDMI video over Layer 3 Managed network hardware. It is advised that VIP products are connected to an independent network switch to prevent interference or drop in signal performance due to other network products bandwidth requirements.

VIP products are not limited to certain brands of network hardware, but should a network switch that RTI have not tested or written instructions for be used, the integrator must ensure it supports the following network features:

Multicast - (one-to-many or many-to-many distribution) is group communication where information is addressed to a group of network devices simultaneously.

Instant Leave / Fast Leave / Immediate Leave - a feature associated with multicast and means that as soon as an active connection is no longer required (the link between Transmitter and Receiver) the multicast group and flow of traffic is stopped instantly. This prevents unnecessary flow of network traffic on the network switch.

IGMP Snooping - the process of listening to Internet Group Management Protocol (IGMP) network traffic. The feature allows a network switch to listen in on the IGMP conversation between hosts and routers (Transmitters and Receivers). By listening to this flow of traffic, the switch maintains a map of which links need which IP multicast streams. Multicasts may be filtered from the links which do not need them and thus controls which ports receive specific multicast traffic.

Jumbo Frames / Jumbo Packets / MTU (Maximum Transmission Unit) - Ethernet frames with more than 1,500 bytes of payload. Conventionally, jumbo frames can carry up to 9,216 bytes of payload, but variations exist and some care must be taken when using the term. Many gigabit Ethernet switches can support jumbo frames.

Please note: RTI have worked with many network switch providers to create setup guides and saved configuration files to help configure the products to work with VIP hardware. These set-up guide files can be downloaded from the RTI website.

Panel Description - VIP-UHD-TX

Front Panel

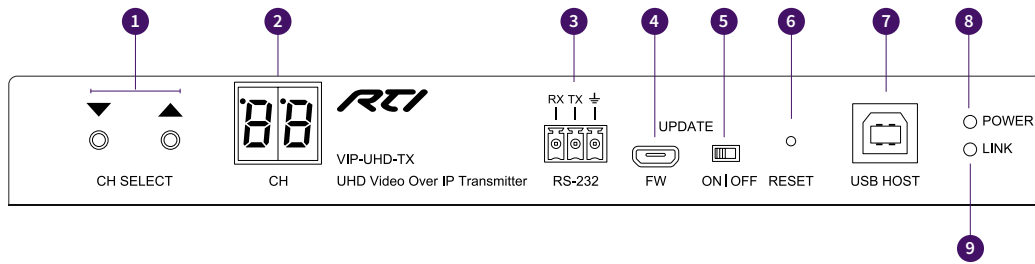

Rear Panel

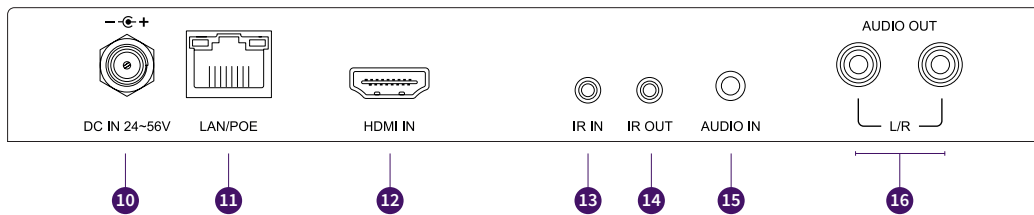

- 1 Channel Select Up/Down - configure unit manually and apply 'Programming mode'
 - 2 Channel status window - displays product information
 - 3 Assignable bi-directional RS-232 ports – connect to control device to extend RS-232 commands to any/multiple VIP products RS-232 port
 - 4 Firmware Micro USB port - update product MCU firmware
 - 5 MCU firmware update switch - place product into firmware update mode (default - OFF)
 - 6 Reset - press and hold for 5 seconds to factory reset the product
 - 7 USB connection for USB/KVM routing within the VIP system
 - 8 Power LED indicator
 - 9 Link LED indicator - solid link light means video data is being transmitted. Flashing LED means the unit is booted and ready, but no video is being transmitted
 - 10 Power port – use 24-56V 1A DC adaptor (sold separately) if not using a PoE network switch
 - 11 LAN Connection (PoE) - connect to Layer 3 Managed switch for HDMI video distribution
 - 12 HDMI input – connect to a HDMI source
 - 13 IR IN (IR input) – 3.5mm stereo jack. Transmits IR to any VIP receiver currently viewing the VIP-UHD-TX. Please use supplied VIP IR Receiver
 - 14 IR OUT - (IR output) - 3.5mm mono jack – routed IR from any VIP-UHD-RX (zone output) allowing source control. Please use supplied VIP IR emitters
 - 15 L/R Analog audio line input - embed analog audio onto HDMI signal
 - 16 L/R Analog audio line output - 2ch audio that supports 2ch PCM source inputs up to 192kHz
- Please note:** Source input must be PCM 2ch audio for analog audio outputs to work. VIP products do not down-mix Dolby or DTS 5.1ch audio signals

Panel Description - VIP-UHD-RX

Front Panel

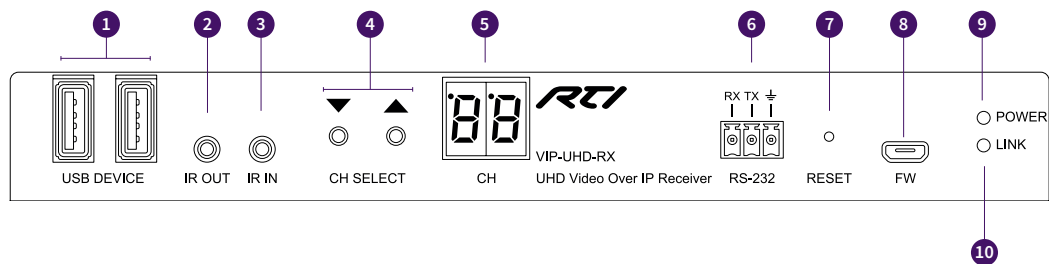

Rear Panel

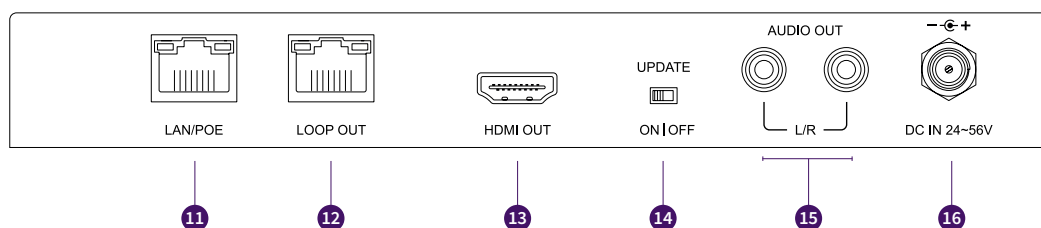

- 1 USB connections for USB/KVM routing within VIP system
- 2 IR OUT - (IR output) - 3.5mm mono jack – routed IR to selected VIP-UHD-TX (source Transmitter). Please use supplied RTI IR emitters
- 3 IR IN (IR input) – 3.5mm stereo jack. Transmits IR to currently selected VIP transmitter allowing routed IR control of sources. Please use supplied RTI IR Receiver
- 4 Channel Select Up/Down - used to scroll through sources (VIP-UHD-TX), setup VIP-UHD-RX manually, and apply ‘Programming mode’
- 5 Channel status window - displays product information
- 6 Assignable bi-directional RS-232 port – connect to control device to extend RS-232 commands to any/multiple VIP products RS-232 port
- 7 Reset - press and hold for 5 seconds to factory reset the product
- 8 Firmware Micro USB port - update product MCU firmware
- 9 Power LED indicator
- 10 Link LED indicator - solid status light indicates a stable connection to the network switch
- 11 LAN Connection (PoE) - connect to Layer 3 managed switch for HDMI video distribution
- 12 LOOP OUT - connect to LAN Connection on subsequent VIP receiver unit for daisy-chain of video IP stream
- 13 HDMI output - connect to a HDMI display
- 14 MCU firmware update switch - place VIP product into firmware update mode
- 15 L/R Analog audio line output - breakout Analog audio from HDMI signal

Please note: Source input must be PCM 2ch audio for analog audio outputs to work. VIP products do not down-mix Dolby or DTS 5.1ch audio signals

Audio outputs are fixed line level output and RX supports 96kHz audio formats only

- 16 Power port – use 24-56V 1A DC adaptor (sold separately) if not using a PoE network switch

Panel Description - VIP-ACM

Front Panel

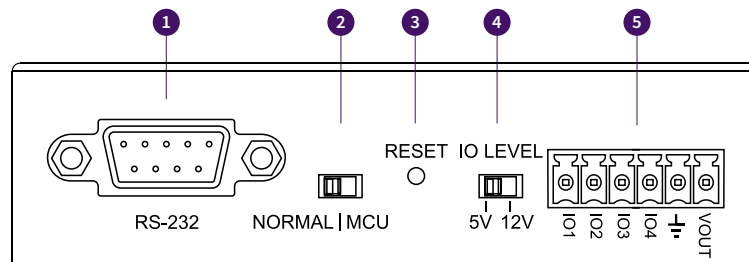

Rear Panel

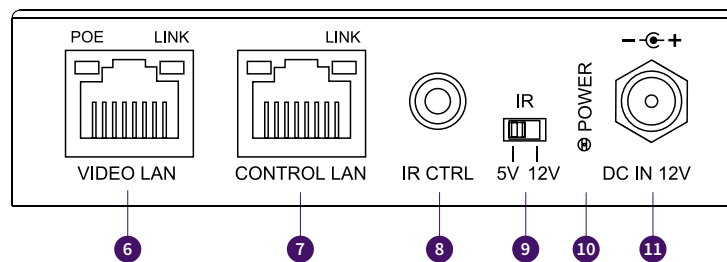

- ❶ RS-232 control port – connect to a third party control device for control of the VIP system using RS-232.
- ❷ MCU Upgrade toggle - use when upgrading MCU firmware only. **Leave in normal position for standard operation.**
- ❸ Reset - short press resets the VIP-UHD-CTRL, long press (10 seconds) factory defaults the VIP-UHD-CTRL.
- ❹ IO Level switch - reserved for future use.
- ❺ IO Level phoenix - reserved for future use.
- ❻ Video LAN (PoE) - connect to the network switch that the VIP components are connected to.
- ❼ Control LAN port - connect to existing network that a third party control system resides on. The Control LAN port is used for Telnet/IP control of the VIP system. Not PoE.
- ❽ IR CTRL (IR input) – 3.5mm stereo jack. Connect to control system if using IR as the chosen method of controlling the VIP system. When using the included 3.5mm stereo to mono cable, ensure the cable direction is correct.
- ❾ IR - adjust IR voltage level between 5V or 12V input for the IR CTRL port.
- ❿ Power LED indicator
- ⓫ Power port – use 12V 1A DC adaptor (sold separately) if not using a PoE network switch.

Schematic - Matrix Configuration

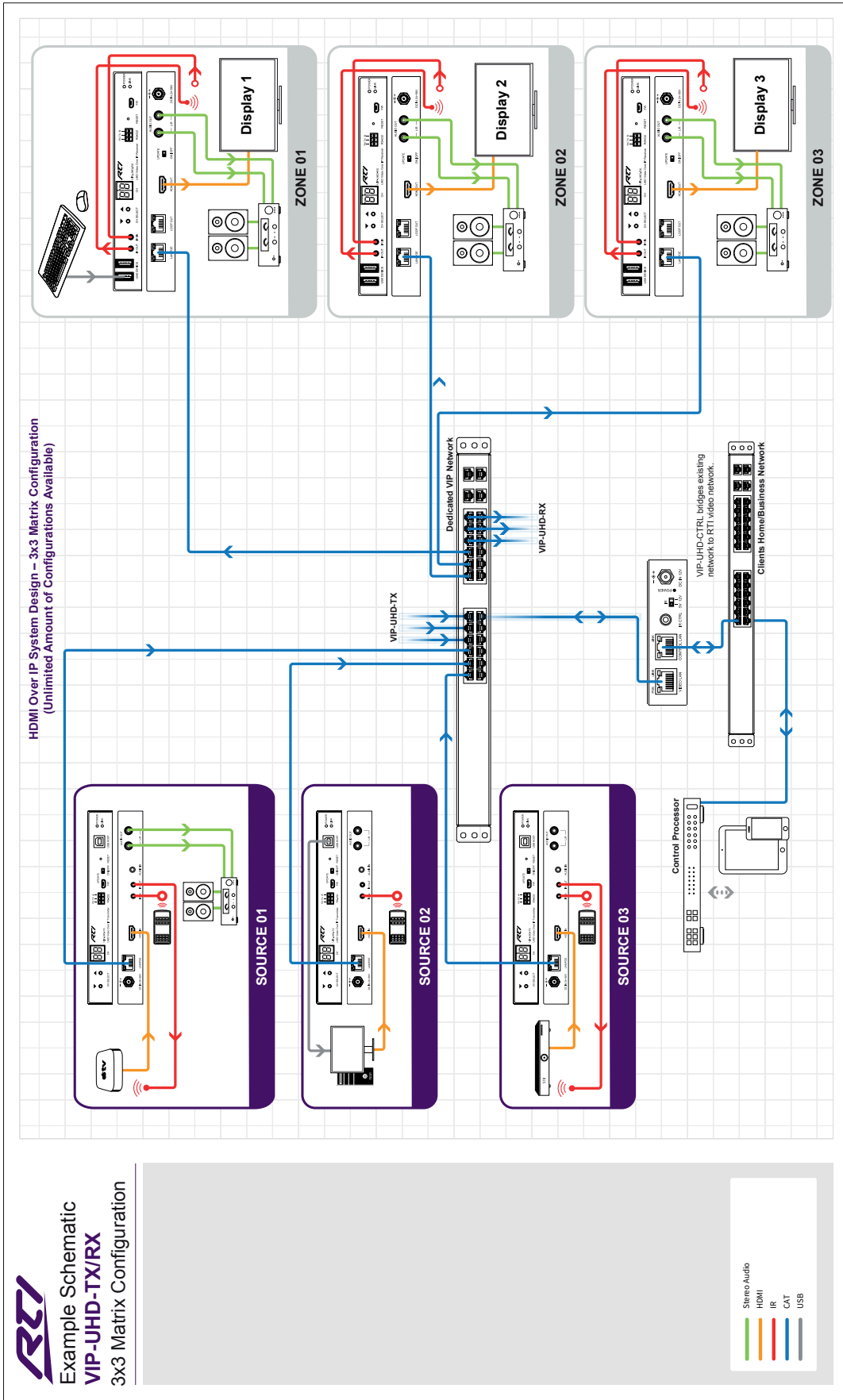

Schematic - Video Wall Configuration

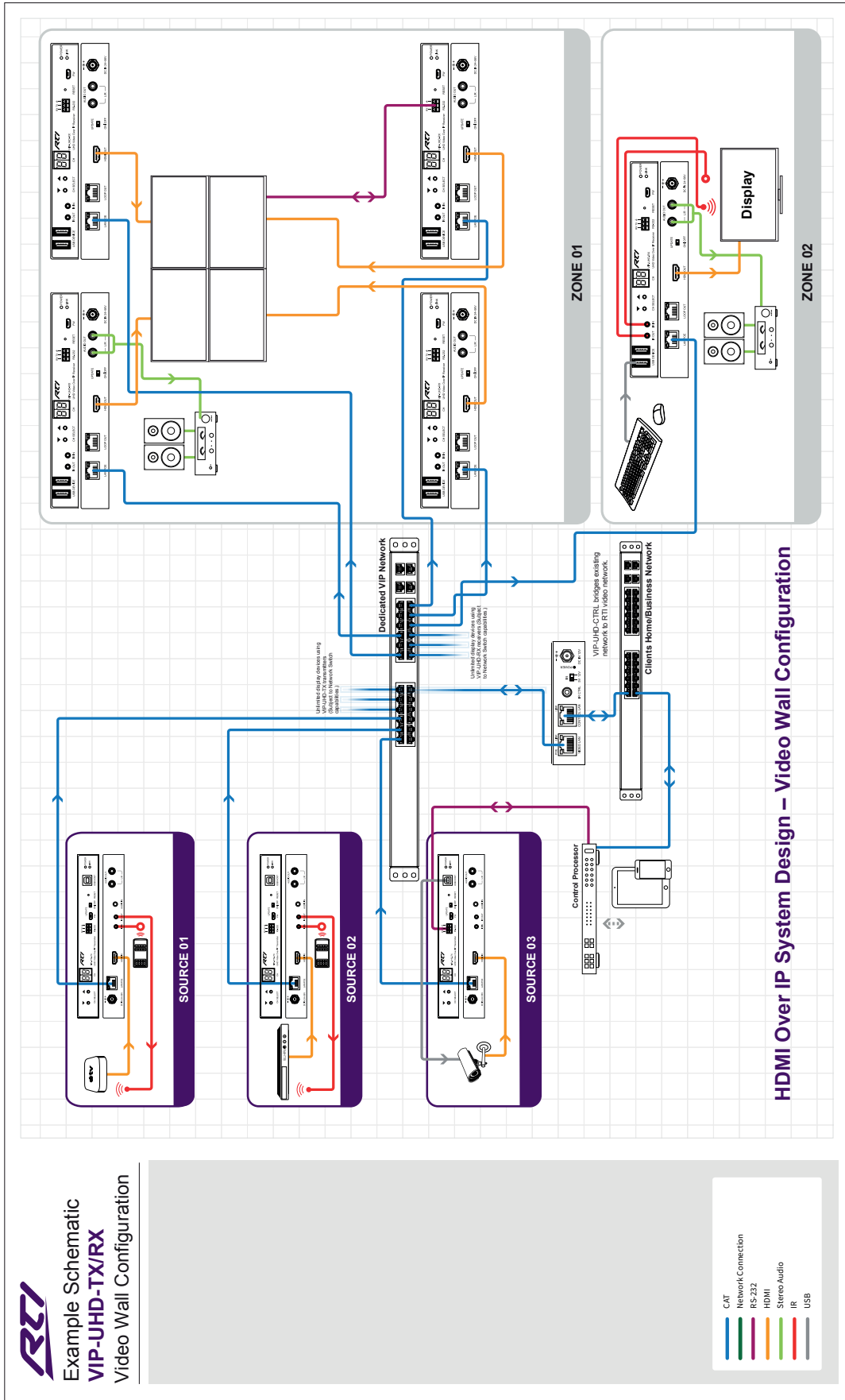

Schematic - One-to-One Configuration

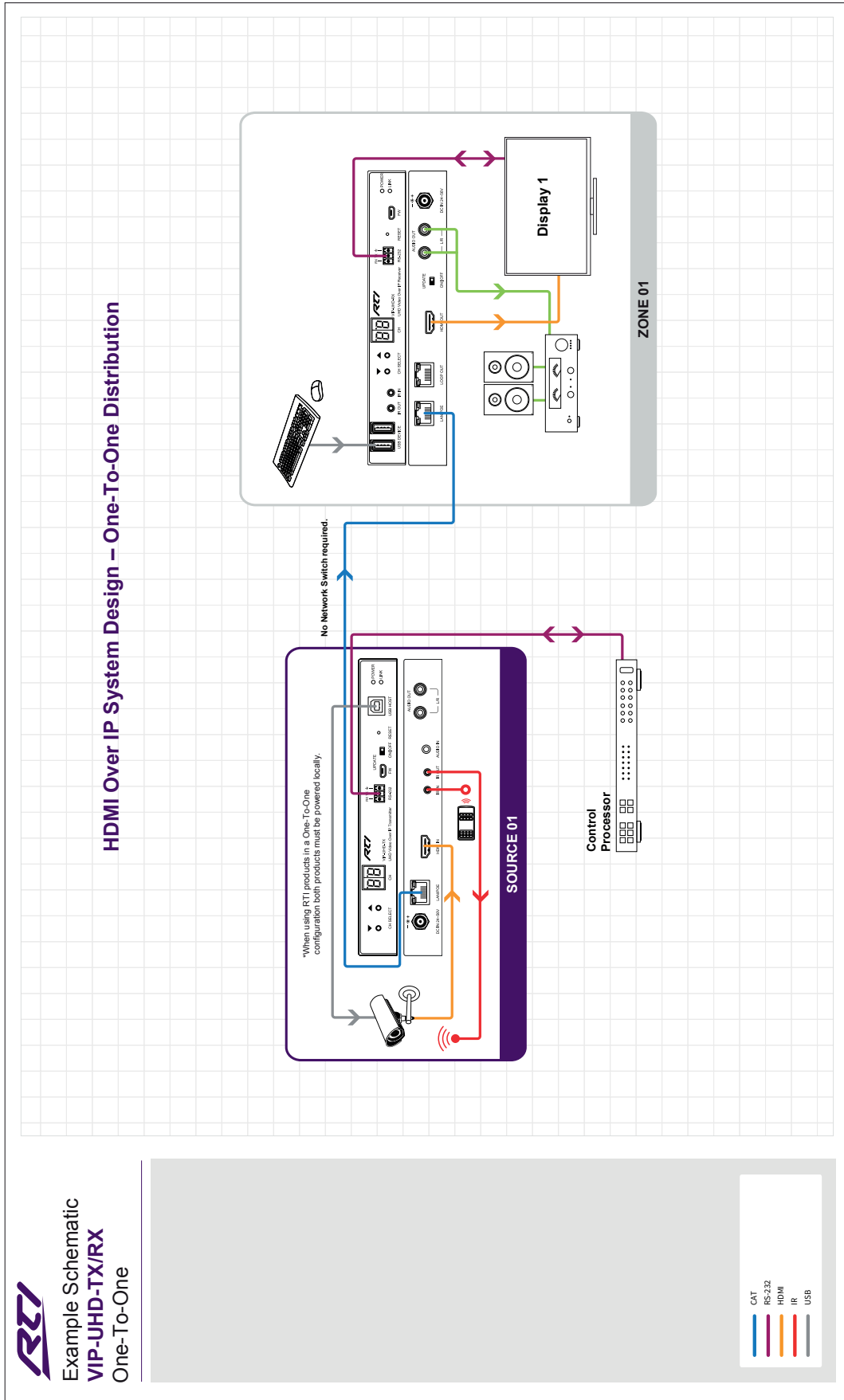

Schematic - One-to-Many Configuration

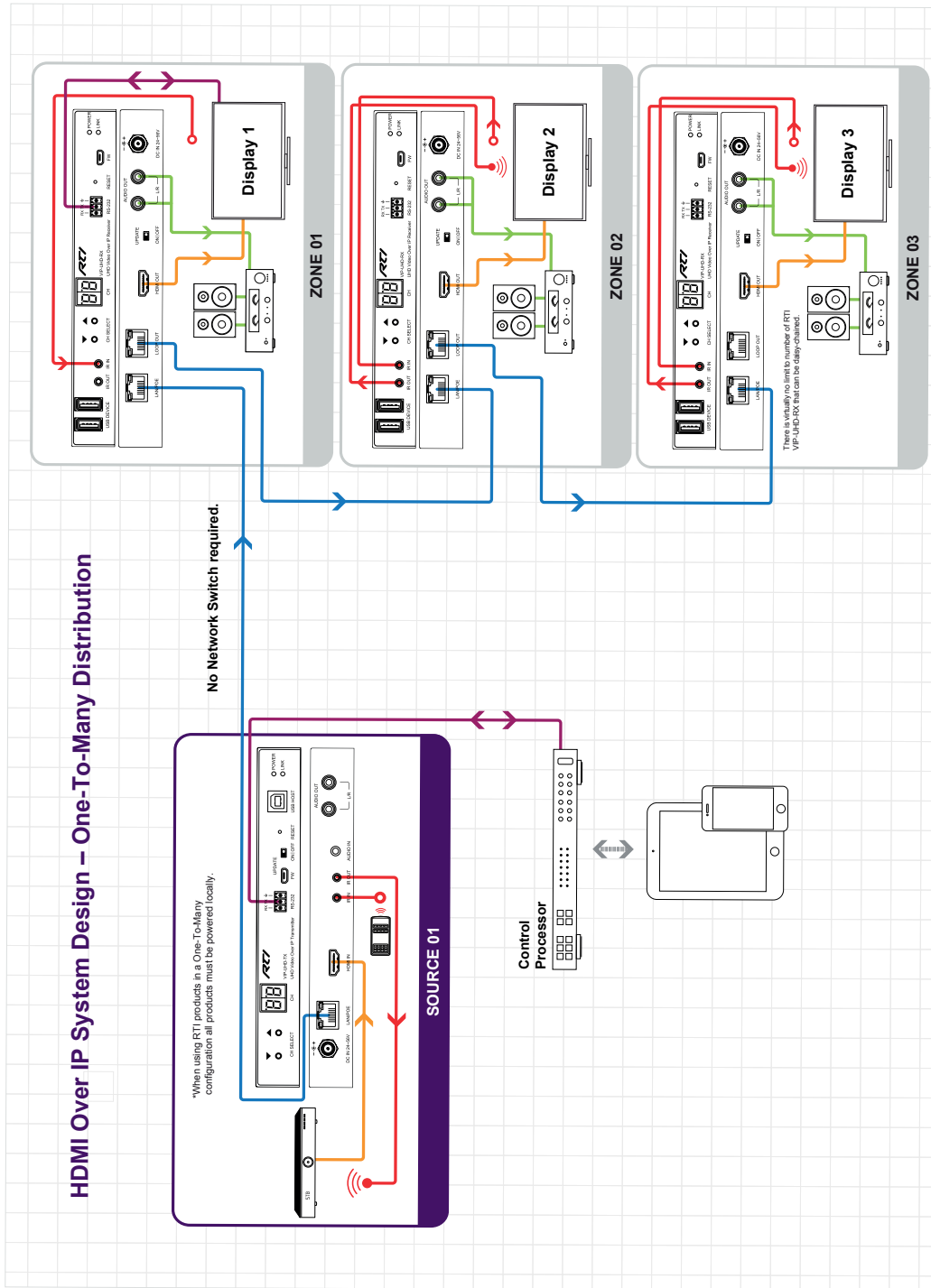

RTI
 Example Schematic
 VIP-UHD-TX/RX
 One-To-Many

Schematic - VIP-UHD-CTRL Network Connection

The VIP-UHD-CTRL acts as a bridge between the control network and video network to ensure that the data travelling between the two networks are not mixed. The VIP-UHD-CTRL must be connected via CAT cable up to 328ft/100m in length in accordance with typical networking requirements.

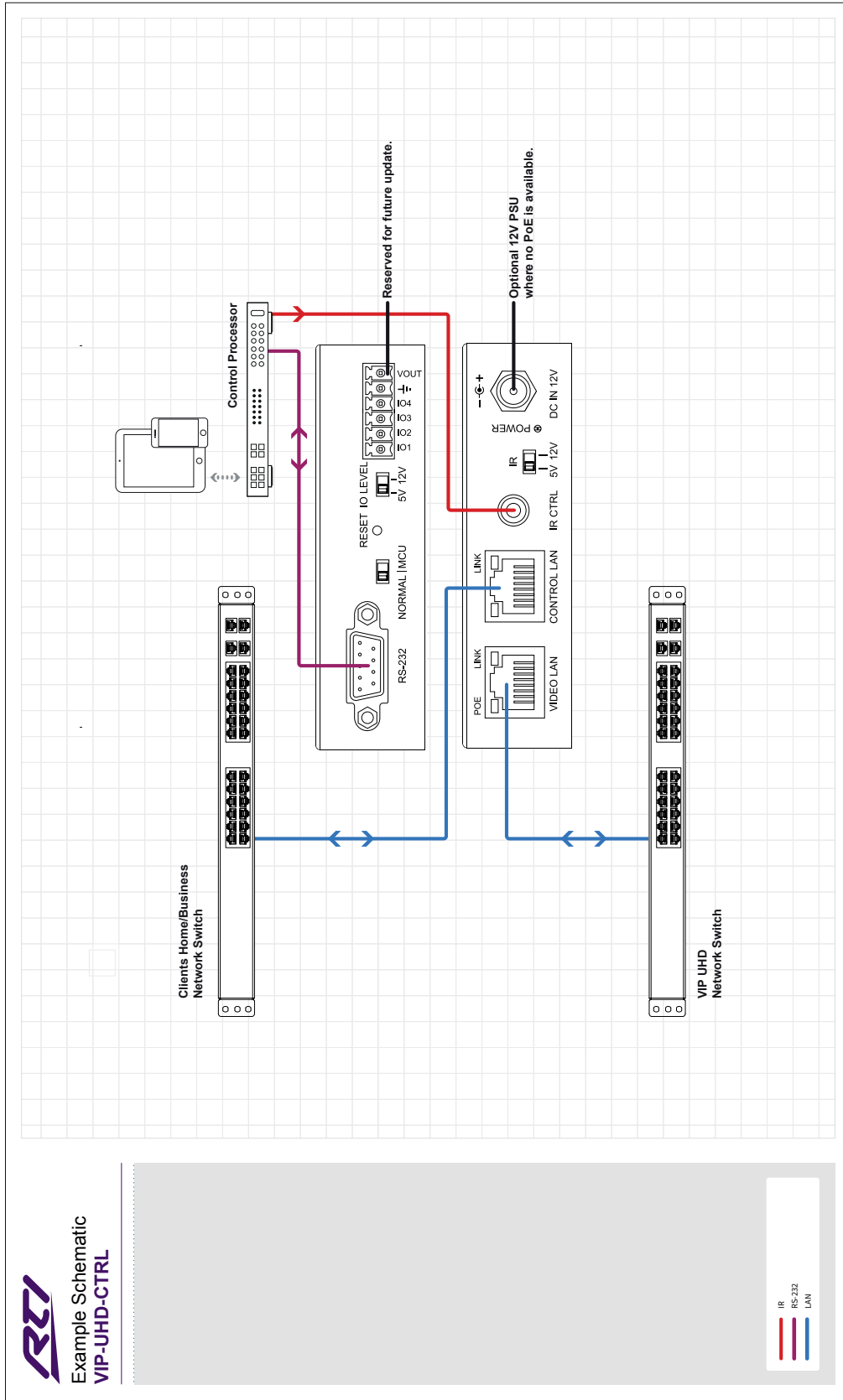

Configuration of a VIP System

There are different ways to configure a new, or manage an existing VIP system:

VIP-UHD-CTRL - Advanced Control Module: (recommended)

The built-in Web-GUI of the VIP-UHD-CTRL allows for full configuration of a new system, as well as on-going maintenance and control of an existing system through a web portal. The VIP-UHD-CTRL can be accessed on devices including: tablets, smart devices, and laptops that are on the same network and able to host a browser. The VIP-UHD-CTRL can also be used as a control platform for the VIP system, with the ability to create multiple users and control individual permissions to govern the switching of pre-determined parts of the local system.

VIP-UHD-TX / RX - Manual Configuration:

Using the buttons on the front of the VIP units, it is possible to configure a very basic system without the need of the VIP-UHD-CTRL, or a PC. Manual configuration allows for each unit to be assigned an individual ID, IP address, EDID settings (Transmitter) and Scaler output settings (Receiver).

Naming of Transmitters or Receivers, as well as advanced features such as Video Wall configuration or fixed routing cannot be undertaken using this configuration method, but has been included to give integrators the option to quickly configure from new, or reset and configure units on the fly.

Manual configuration is covered in this manual from page 59 onwards.

VIP-UHD-TX / RX - Web-GUI:

Each individual VIP unit hosts its own web interface, accessed through a web browser from a PC connected directly to the VIP network. The units web-GUI can be used for amending system settings, and configuration of advanced features of the VIP system where these settings are not commonly accessed and therefore not built into the VIP-UHD-CTRL web-GUI.

An overview of the VIP-UHD web-GUI is contained within this manual from page 62 onwards.

Please note: we would not recommend accessing or using the individual units web-GUI for configuration unless instructed to do so by a member of the RTI Technical Support team. The fundamental features for configuration of a VIP system have all been designed into the VIP-UHD-CTRL.

Configuration of a VIP System - continued...

RTI VIP Transmitters and Receivers are shipped as new with a default IP address of:

169.254.100.254

Each of the configuration tools of the VIP system work by assigning individual VIP-UHD units to a fixed IP address. No two units can have the same IP address for the system to work seamlessly as a conflict of IP addresses will appear on the network. The VIP Transmitters create a multicast stream from the HDMI input signal that is fed into the VIP network for the VIP Receivers to connect to and decode back into HDMI.

The maximum number of Transmitters and Receivers a VIP system can have is governed by the range of IP addresses the configuration tool assigns. This is 762x762. For a system that contains more than 762 Transmitters or Receivers, please contact a member of the RTI Technical Support team.

IP addresses are configured as follows:

Transmitters:

- The first Transmitter will be given the IP address of 169.254.3.1. The next Transmitter will be assigned an IP address of 169.254.3.2 and so on....
- Once the IP range of 169.254.3.x is filled (254 units), the software will auto assign an IP address of 169.254.4.1 and so on...
- Once the IP range of 169.254.4.x is filled (254 units), the software will auto assign an IP address of 169.254.5.1 and so on until 169.254.4.254.

Receivers:

- The first Receiver will be given the IP address of 169.254.6.1. The next Receiver will be assigned an IP address of 169.254.6.2 and so on....
- Once the IP range of 169.254.6.x is filled (254 units), the software will auto assign an IP address of 169.254.7.1 and so on...
- Once the IP range of 169.254.7.x is filled (254 units), the software will auto assign an IP address of 169.254.8.1 and so on until 169.254.8.254.

Assigning IP addresses into a different range is possible, and is only recommended this is done where the VIP system is to sit on a clients existing network with the capability to host the bandwidth requirements of the VIP system. Where a VIP system is not being incorporated into an existing network, it should be on it's own network and therefore should be no reason to not use the recommended IP address range.

Should the requirement to locate the VIP system on an existing network, the following points should be taken into consideration before designing a new system.

- The framework of the VIP-UHD-CTRL is based around communication in the 169.254.x.x IP address range by default
- The VIP-UHD-CTRL can be used outside of the recommended IP address range if required
- Manual configuration will assign IP addresses into the 169.254.x.x range only

Please contact a member of the RTI Technical Support team to discuss moving a VIP system to an alternative IP address range, and the procedure to be followed when undertaking the configuration of a new system.

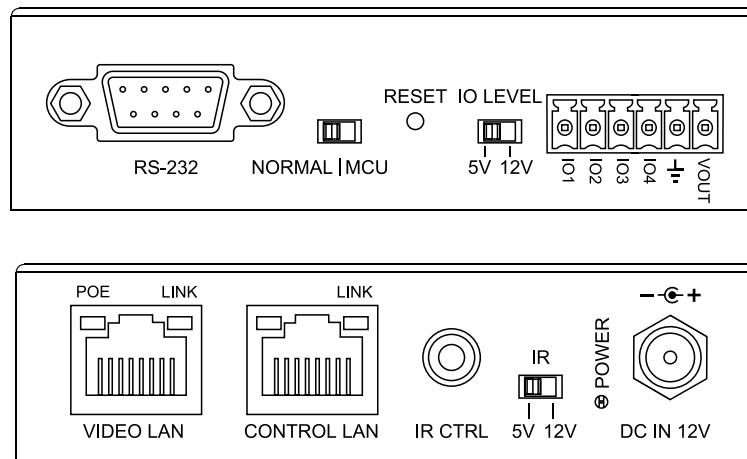

VIP-UHD-CTRL Features

- Web interface module for configuration and control of the VIP system
- Intuitive 'Drag & Drop' source selection with thumbnail preview feature for active monitoring of system status
- Advanced signal management for independent routing of Video, Audio, IR, RS-232, USB/KVM and CEC
- Auto system configuration
- 2x RJ45 LAN connections to bridge existing network to VIP video distribution network, resulting in:
 - Better system performance as network traffic is separated
 - No advanced network setup required
 - Independent IP address per LAN connection
 - Allows simplified TCP / IP control of Multicast system
- RS-232 integration for control of VIP system
- IR integration for control of VIP system
- PoE (Power over Ethernet) to power the VIP-UHD-CTRL from a PoE switch
- Local 12V power supply (optional) should the switch not support PoE
- Multiple user control interface options with source and zone permissions

VIP-UHD-CTRL Control Ports

The VIP-UHD-CTRL communication ports are located on both end panels and include the following connections:

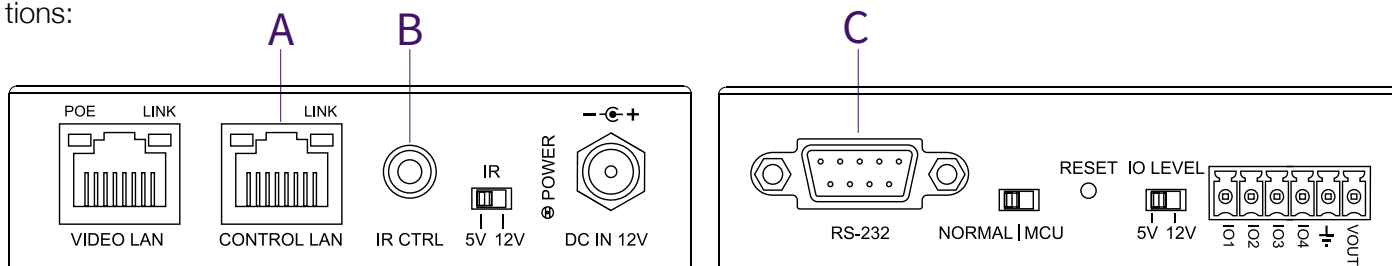

Connections:

- A. TCP/IP – for full VIP system control (RJ45 Connector)
- B. InfraRed (IR) Input* - 3.5mm stereo jack - for VIP switching control only
- C. RS-232 – for full VIP system control / RS-232 pass-through (DB9)

Please note: the VIP-UHD-CTRL can be used with both 5V and 12V IR line systems. Please ensure that the switch (adjacent to the IR CTRL port) is correctly selected to the specification of the IR line input.

TCP/IP:

The VIP-UHD-CTRL can be controlled via TCP/IP.

For the full list of protocols please see 'RS-232 & Telnet Commands' located towards the rear of this guide.

A 'straight-through' RJ45 patch lead should be used when connected to a network switch.

Control Port:	23
Default IP:	DHCP (192.168.0.225 when not connected to a DHCP server)
Default Username:	RTI
Default Password:	RTI123

RS-232:

The VIP-UHD-CTRL can be controlled via serial using the serial DB9 connector. Default settings as below:

For the full list of command protocols please see 'RS-232 & Telnet Commands' located at towards rear of this guide.

Baud Rate:	57600
Data Bit:	8-bit
Parity:	None
Stop Bit:	1-bit
Flow Control:	None

The Baudrate for the VIP-UHD-CTRL can be adjusted using the built-in web-GUI, or by issuing the following command via RS-232 or Telnet:

RSB x : Set RS-232 Baud Rate to X bps

Where X = 0 : 115200 1 : 57600 2 : 38400 3 : 19200 4 : 9600

VIP-UHD-CTRL Control Ports - IR Control

The VIP system can be controlled using local IR. Source selection is the only feature available when using local IR control - advanced features of the VIP-UHD-CTRL such as video wall mode, audio embedding etc. can only be achieved using RS-232 or TCP/IP control.

RTI have created 16x input & 16x output IR commands allowing source selection of up to 16x VIP Transmitters on up to 16x VIP Receivers. For systems larger than 16x source devices (VIP-UHD-TX) RS-232 or TCP/IP control will be required.

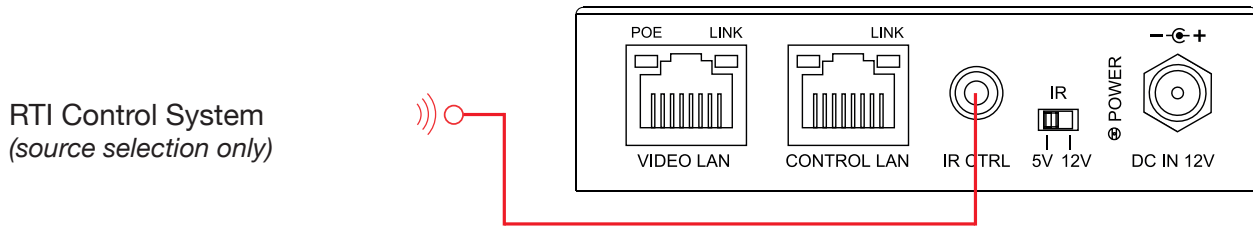

The VIP-UHD-CTRL is compatible with both 5V and 12V IR equipment. When the VIP-UHD-CTRL is being used to receive an IR input to the 'IR CTRL' port, the adjacent switch must be toggled correctly to match the IR voltage line of the chosen control system prior to connection. **Please note:** RTI processors are all 12V.

3.5mm Stereo to Mono Cable (included)

RTI IR Control cable 3.5mm Mono to 3.5mm Stereo for linking an RTI control solution to RTI distribution-products.

Please note: cable is directional as indicated

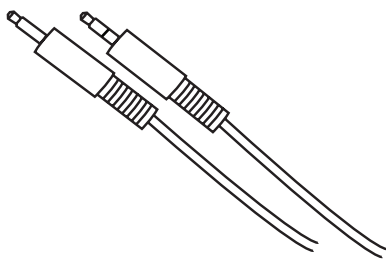

IR Receiver - stereo 3.5mm jack (optional)

RTI 12V IR receiver to receive an IR signal and distribute through RTI products

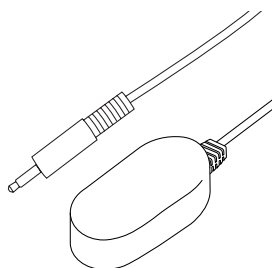

Wiring pin - IR Control Cable - stereo 3.5mm jack:

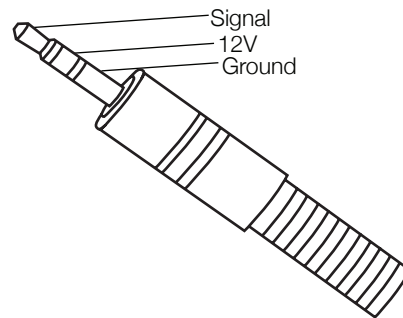

Wiring pin - IR Control Cable - mono 3.5mm jack:

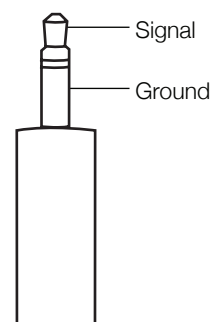

VIP-UHD-CTRL - Web-GUI Guide

The web-GUI of the VIP-UHD-CTRL allows for full configuration of a new system, as well as on-going maintenance and control of an existing system through a web portal. The VIP-UHD-CTRL can be accessed on any network connected device including: tablets, smart phones and laptops.

Sign In

Before logging in to the VIP-UHD-CTRL, ensure that the control device (i.e. laptop / tablet) is connected to the same network as the VIP-UHD-CTRL Control Port. There are instructions of how to amend the static IP address of a PC at the rear of this manual.

To log in, open a web browser (i.e. Chrome, Internet Explorer etc.) Type in **rti-vip-ctrl.local** on a device connected to the same network as the VIP-UHD-CTRL and it will automatically take you to the units web interface.

Please note: the VIP-UHD-CTRL is shipped with DHCP on by default. Should the network not contain a DHCP server, the VIP-UHD-CTRL can be found on its default IP address at **192.1268.0.225**

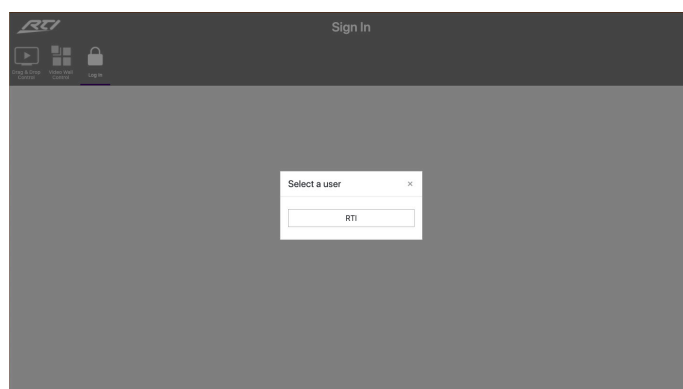

The sign in page is presented on connection to the VIP-UHD-CTRL. Once Users have been created within the system, this screen will be populated with the Users previously configured for future log ins. The default admin PIN is:

RTI123

Please note: the default admin password must be changed after first sign in.

A screenshot of a dialog box titled 'Sign in with RTI'. It features two text input fields: the first is labeled 'RTI' and the second is labeled 'Password'. At the bottom of the dialog, there are two buttons: a white 'Back' button and a purple 'Sign In' button.A screenshot of a dialog box titled 'Update password'. It contains three text input fields: 'RTI', 'New Password', and 'Confirm New Password'. At the bottom, there is a single button labeled 'Update Password'.

New Project Setup Wizard

On first log in of the VIP-UHD-CTRL, a Setup Wizard for configuring all components of the VIP system will be presented. This has been designed to speed up new system configuration as all default / new VIP Transmitters & Receivers can be connected to the network switch at the same time, whilst not resulting in an IP conflict during the system configuration. This results in a system in which all components are automatically and sequentially assigned a name and IP address ready for basic system use.

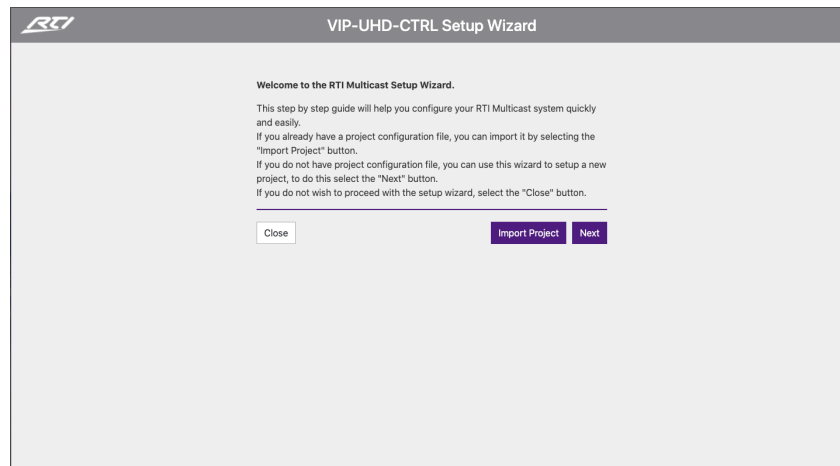

The VIP-UHD-CTRL Setup Wizard can be cancelled by clicking 'Close'. Please be aware that the system will not be configured at this point, but can be continued by visiting the 'Project' menu (see page 28). If a project file is already available (i.e. replacing a VIP-UHD-CTRL on an existing site), this can be imported by using the exported (.json) save file by clicking 'Import Project'.

Click 'Next' to continue setup:

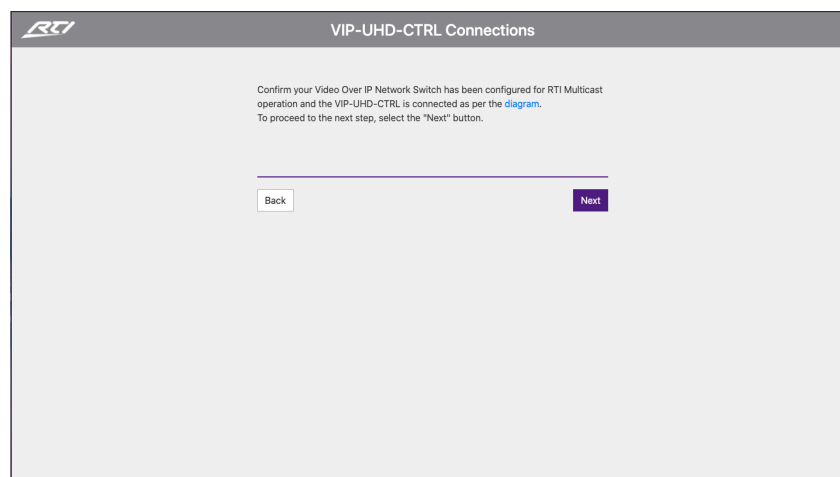

An example schematic diagram for the connections of the VIP-UHD-CTRL can be accessed by clicking the hyperlink marked 'diagram'. This will ensure the VIP-UHD-CTRL is connected correctly to the wider VIP system before the Setup Wizard begins. Once the connections of the VIP-UHD-CTRL, are confirmed click 'Next'. The connections diagram is included on page 12 of this guide.

New Project Setup Wizard... continued...

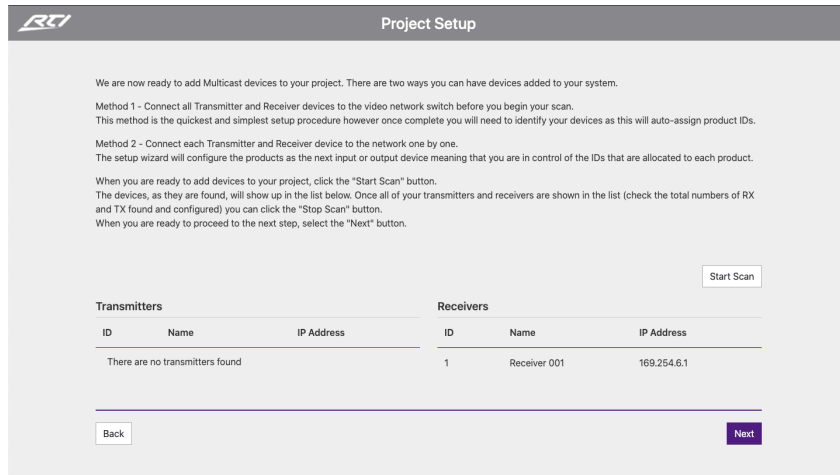

There are two methods for adding new VIP Transmitter and Receiver devices to a system, please choose one before clicking 'Start Scan':

Method 1:

It is recommended this method be used if pre-configuring a VIP system prior to physical location / installation of the hardware in a rack, or local to displays.

Connect ALL VIP-UHD Transmitter and Receiver units to the VIP network switch with their factory default IP addresses at 169.254.100.254. This method will quickly configure all devices with their own individual IP addresses based on the standard RTI VIP IP configuration rules as set out on page 14 of this guide.

Once complete, devices will need to be identified manually. This method auto-assigns product IP addresses and ID's to each device connected to the network switch randomly (not by switch port).

It is possible to identify / label units as they are configured by looking for the individual units re-booting (the dual 7-segment display rotates clockwise during re-boot) as they are assigned by the VIP-UHD-CTRL.

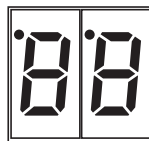

CH

Method 2:

It is recommended this method be used if the VIP hardware has been pre-installed prior to configuration.

Connect each VIP Transmitter and Receiver to the network one-by-one. The Setup Wizard will configure the units sequentially as they are connected / found. This method allows for the control of the sequential assigning of IP addresses and ID's of each product - the Transmitter / Receiver units can therefore be pre-installed into a project prior to configuration.

New Project Setup Wizard... continued...

Once the setup method to configure the system has been chosen, hit the 'Start Scan' button.

The VIP-UHD-CTRL will search for new VIP-UHD units on the network and will continue to search for new devices until such time as:

- The 'Stop Scan' button is pressed
- The 'Next' button is clicked to progress the Setup Wizard once all units have been found

Project Setup

We are now ready to add Multicast devices to your project. There are two ways you can have devices added to your system.

Method 1 - Connect all Transmitter and Receiver devices to the video network switch before you begin your scan. This method is the quickest and simplest setup procedure however once complete you will need to identify your devices as this will auto-assign product IDs.

Method 2 - Connect each Transmitter and Receiver device to the network one by one. The setup wizard will configure the products as the next input or output device meaning that you are in control of the IDs that are allocated to each product.

When you are ready to add devices to your project, click the "Start Scan" button.

The devices, as they are found, will show up in the list below. Once all of your transmitters and receivers are shown in the list (check the total numbers of RX and TX found and configured) you can click the "Stop Scan" button.

When you are ready to proceed to the next step, select the "Next" button.

Transmitters			Receivers		
ID	Name	IP Address	ID	Name	IP Address
There are no transmitters found			1	Receiver 001	169.254.6.1

As new units are found by the VIP-UHD-CTRL, the units will populate to the relevant columns marked Transmitters or Receivers. It is recommended to label the unit / box for future identification at this point.

Project Setup

We are now ready to add Multicast devices to your project. There are two ways you can have devices added to your system.

Method 1 - Connect all Transmitter and Receiver devices to the video network switch before you begin your scan. This method is the quickest and simplest setup procedure however once complete you will need to identify your devices as this will auto-assign product IDs.

Method 2 - Connect each Transmitter and Receiver device to the network one by one. The setup wizard will configure the products as the next input or output device meaning that you are in control of the IDs that are allocated to each product.

When you are ready to add devices to your project, click the "Start Scan" button.

The devices, as they are found, will show up in the list below. Once all of your transmitters and receivers are shown in the list (check the total numbers of RX and TX found and configured) you can click the "Stop Scan" button.

When you are ready to proceed to the next step, select the "Next" button.

Transmitters			Receivers		
ID	Name	IP Address	ID	Name	IP Address
1	Transmitter 001	169.254.3.1	1	Receiver 001	169.254.6.1
2	Transmitter 002	169.254.3.2	2	Receiver 002	169.254.6.2
3	Transmitter 003	169.254.3.3	3	Receiver 003	169.254.6.3
4	Transmitter 004	169.254.3.4	4	Receiver 004	169.254.6.4

Once all units have been found and configured, click 'Stop Scan', then 'Next'.

New Project Set-up Wizard... continued...

The Device Set-up page allows for Transmitters and Receivers to be named accordingly. EDID and Scaler settings for the individual Transmitters or Receivers can be set as required. For help with EDID and Scaler settings, click the relevant buttons marked 'EDID Help' or 'Scaling Help'.

Configure your Transmitters and Receivers as required:

1. Customise the name for each device.
2. Specify an EDID for each Transmitter.
3. Configure the scaler output resolution for each Receiver.

Once configured the Multicast Receivers will automatically display their unique product identity on screen
To help identify the Multicast Transmitter products each Transmitter has a 'VIEW' button. Once pressed a preview video window of the source will be displayed.
For additional information select the "Scaling Help" or "EDID Help" button.
Note: Some devices may still be restarting from the initial setup, you will have to wait for these devices to restart before updating them.
When you are ready to proceed to the next step, select the "Next" button.

EDID Help OSD Help Turn OSD Off Scaling Help

Transmitters				Receivers			
ID	Name	EDID		ID	Name	Scaler Resolution	
1	Transmitter 001	Default EDID	View	1	Receiver 001	Pass Through	Actions
2	Transmitter 002	Default EDID	View	2	Receiver 002	Pass Through	Actions
3	Transmitter 003	Default EDID	View	3	Receiver 003	Pass Through	Actions
4	Transmitter 004	Default EDID	View	4	Receiver 004	Pass Through	Actions

Back Next

Features of the Device Set-up page include:

1. **Name of Devices** - during configuration the Transmitters / Receivers are automatically assigned default names i.e. Transmitter 001 etc. Transmitter / Receiver names can be amended by typing in the corresponding box.
2. **EDID** - fix the EDID value for each Transmitter (source). This is used to request specific video and audio resolutions for the source device to output. Basic help with EDID selection can be obtained by clicking the button marked 'EDID Help'. See page 29 for a full list of EDID settings that can be applied.
3. **View** - opens the following pop-up:

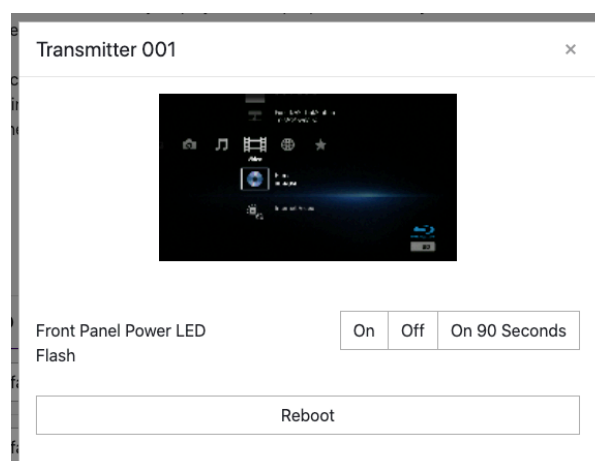

This pop-up shows an image preview of the media currently being streamed by the Transmitter unit. The ability to identify the unit by flashing the front panel LED's on the unit, and the ability to Reboot the unit.

4. **Scaler Resolution** - adjust the output resolution using the built-in video scaler of the VIP Receiver. The scaler is capable of both upscaling and downscaling the incoming video signal, however, upscaling is not recommended. See page 32 for a full list of Scaler output settings that can be applied.

New Project Setup Wizard... continued...

6. **Actions** - opens the following pop-up:

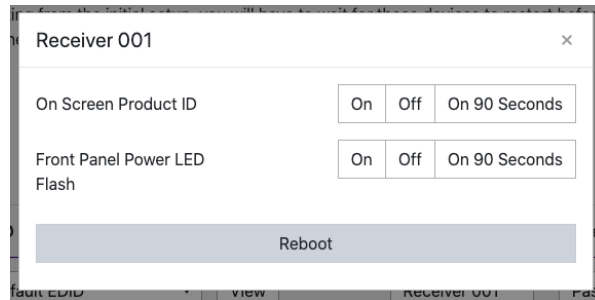

This pop-up gives you the ability to display the product ID on the connected display by way of an OSD (On Screen Display) as an overlay to the media being accepted by the Receiver. The ability to identify the unit by flashing the front panel LED's, and the ability to Reboot the unit is contained here.

7. **Turn OSD On / Off** - toggles the product ID onto the connected screen / display by way of an OSD (as described above).

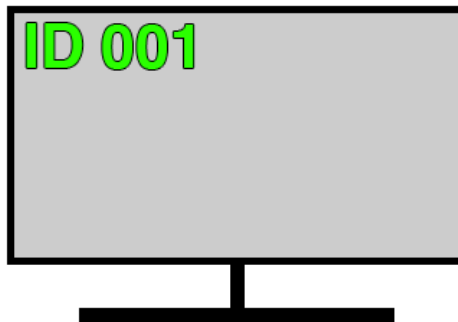

8. **Next** - continues to the Setup Wizard Completion page (shown below)

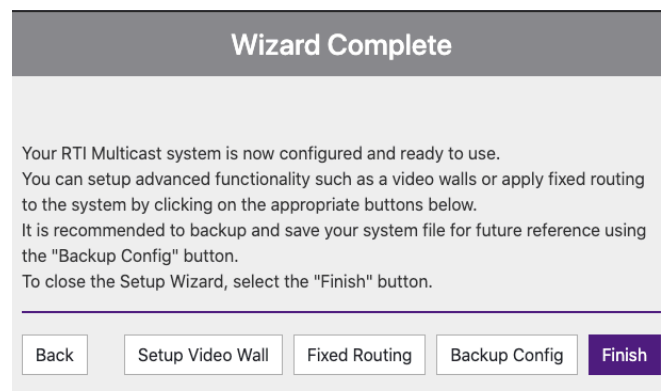

The Wizard Completion page finalises the basic configuration process and provides links for advanced set-up options for Video Walls, Fixed Signal Routing (IR, RS-232, Audio etc), and the ability to back-up to a configuration file (*recommended*).

Click 'Finish' once done to continue to the 'Drag & Drop Control' page, logged in as Administrator.

Web-GUI - Menu Overview

The 'User Interface' menu gives an end user the ability to switch and preview the entire VIP system without allowing access to any settings that can change the overall infrastructure of the system.

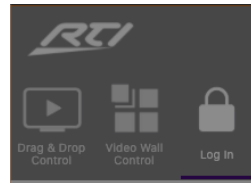

1. **Drag & Drop Control** - used for 'Drag & Drop' control of source selection for each VIP Receiver including image preview of source devices throughout
2. **Video Wall Control** - used for 'Drag & Drop' control of source selection for each video wall array within the system, including image preview of source devices throughout
3. **Log In** - used to log into the system as a User or Administrator

The **Admin** menu is accessed from a single password (see page 18 for log-in details). This menu allows for the VIP system to be completely reconfigured with access to all settings and features of the system.

Please note: it is not recommended to leave Admin access or the Admin password with an end user.

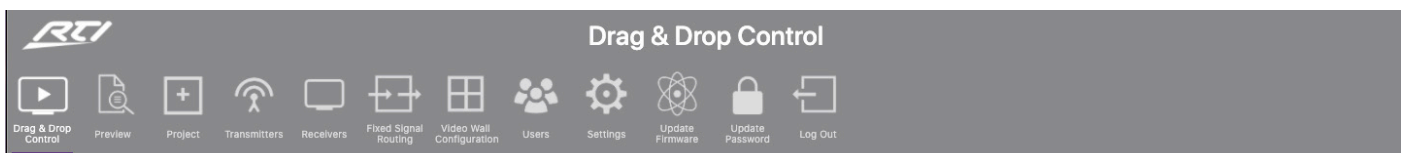

1. **Drag & Drop Control** - 'Drag & Drop' control of source selection for each VIP Receiver including image preview of source devices
2. **Video Wall Control** - 'Drag & Drop' control of source selection for each video wall array within the system, including image preview of source devices
3. **Preview** - show the active video stream from any connected VIP Transmitter or Receiver
4. **Project** - configure a new or existing VIP system
5. **Transmitters** - summary of all VIP Transmitters installed, with options for EDID management, checking FW version, updating settings, adding new TX's, replacing or rebooting products
6. **Receivers** - summary of all VIP Receivers installed, with options for resolution output (HDR / scaling), function (video wall mode / matrix), updating settings, adding new RX's, replacing or rebooting products
7. **Fixed Signal Routing** - signal routing allowing independent routing of IR, RS-232, USB / KVM, Audio and Video signals
8. **Video Wall Configuration** - set-up and configuration of VIP Receivers to create a video wall array of up to a size of 9x9, including: bezel / gap compensation, stretch / fit, and rotation
9. **Users** - set-up / manage Users and permissions of the system
10. **Settings** - access to various system settings including: network and reset the VIP-UHD-CTRL
11. **Update Firmware** - applying the latest firmware updates to the VIP-UHD-CTRL and connected VIP Transmitters and Receivers
12. **Update Password** - update the Admin password for access to the VIP-UHD-CTRL Web-GUI
13. **Log Out** - log out the current User / Admin

Web-GUI - Drag & Drop Control

The VIP-UHD-CTRL Drag & Drop Control page is used to quickly and intuitively change a source input (Transmitter) for each display (Receiver). This page has been designed to allow the User to quickly switch the I/O configuration of the system. Once the system has been fully configured the Drag & Drop Control page will show all online VIP Transmitter and Receiver products. All VIP products will display the active stream from the device which refreshes every few seconds.

Due to the size of the display window on certain phones, tablets or laptops, should the number of Transmitters and Receivers be larger than the size available on screen, the User is able to scroll horizontally through available devices (left to right).

To switch sources, click and hold on the required source and 'Drag & Drop' the Transmitter preview onto the required Receiver product. The Receiver preview window will update with the new live stream of the source selected. The Drag & Drop switch will amend the Video/Audio stream from Transmitter to Receiver, but not Fixed Routing of control signals.

Should 'No Signal' be displayed in the Transmitter preview window, please check the HDMI source device is powered, outputting a signal, and is connected via HDMI cable to the VIP Transmitter unit. Check also the EDID settings of the Transmitter device (VIP will not accept HDMI signals exceeding 10.2Gbps). Should 'No Signal' be displayed inside the Receiver preview window, check the unit is connected and powered from the network (switch) and has a valid connection to a working Transmitter unit.

There is an 'All Receivers' window located on the left of the Receivers window. Dragging and dropping a Transmitter onto this window will change the routing for ALL Receivers within the system to watch the source selected. Should the preview of this window show the RTI logo, this signifies that there is a mixture of sources being watched across the range of Receivers within the system. The note underneath 'All Receivers' will display: 'TX: Different'.

Please note: the Drag & Drop Control page is also the home page for Guest Users of the VIP system - only sources that the Guest or User have permission to view will be visible. For User set-up and permissions, see page 43. Receivers in Video Wall Mode are not displayed on the Drag & Drop page.

Web-GUI - Video Wall Control

To assist with simplified Video Wall switching control, there is a separate Video Wall Drag & Drop Control page. This menu option is only available once a Video Wall has been configured into the VIP system.

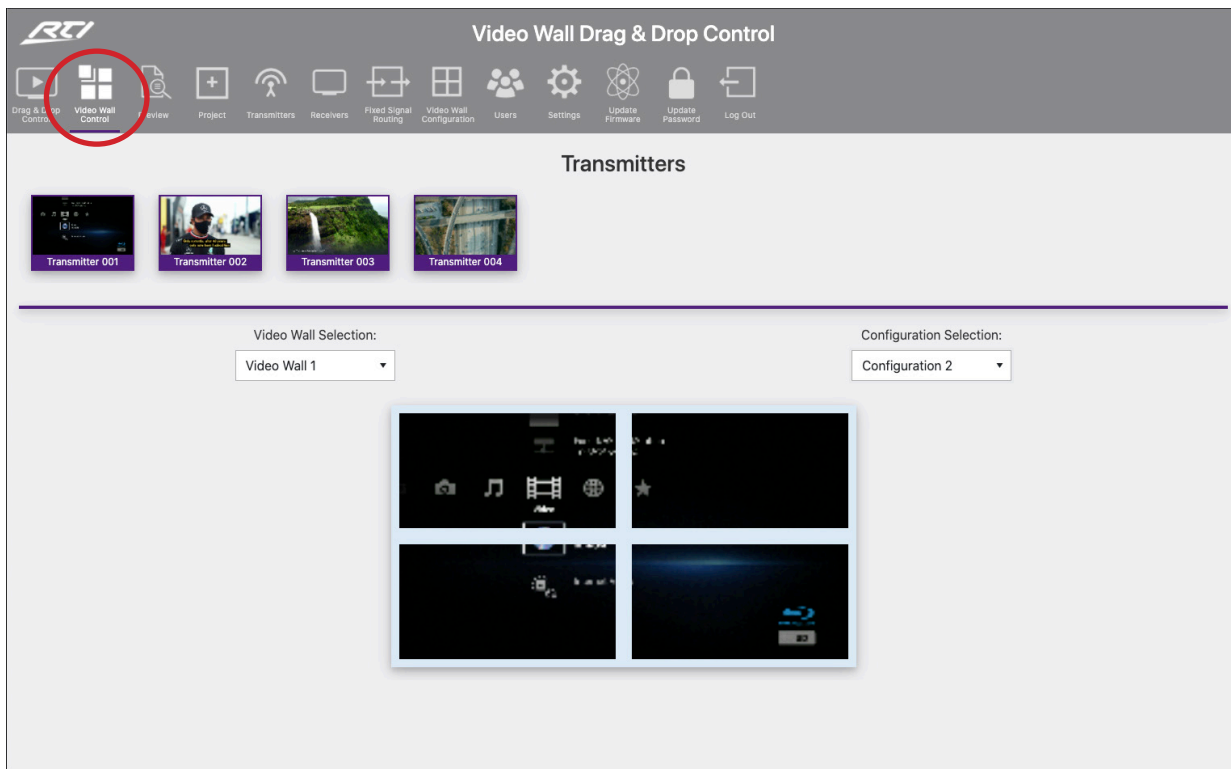

The source (Transmitter) preview windows are shown at the top of the page with the graphical representation of the Video Wall displayed below. To switch the Video Wall array from one source to another Drag & Drop the source preview window onto the Video Wall preview underneath. This will switch all connected screens within the Video Wall (within a group within a Video Wall only) to the same source / Transmitter in the Configuration that is currently selected (in a group). Or Drag & Drop a Transmitter preview onto a 'Single' screen when the Video Wall array is in an individual screen configuration.

RTI VIP systems can have multiple Video Walls. Selecting a different Video Wall array, or to deploy a pre-defined Configuration / preset for each Video Wall can be carried out by using the drop down boxes above the graphical representation of the Video Wall. This graphical representation will automatically update as you select a different Video Wall or Configuration.

Should a screen within a Video Wall display on the GUI show 'RX Not Assigned', this means that the Video Wall does not have a Receiver unit assigned to the array. Please revert back to Video Wall set up to assign the Receiver accordingly.

For the advanced API commands for control of Video Wall arrays within an RTI VIP system, please refer to the API Commands section at the rear of this manual.

Web-GUI - Preview

The Preview feature is a quick way to view the media being streamed through the VIP system once configured. Used to preview the stream from any HDMI source device into the VIP Transmitter, or the stream being received by any Receiver in the system concurrently. This is particularly helpful for debugging and checking source devices are powered on and outputting a HDMI signal, or to check the I/O status of the system:

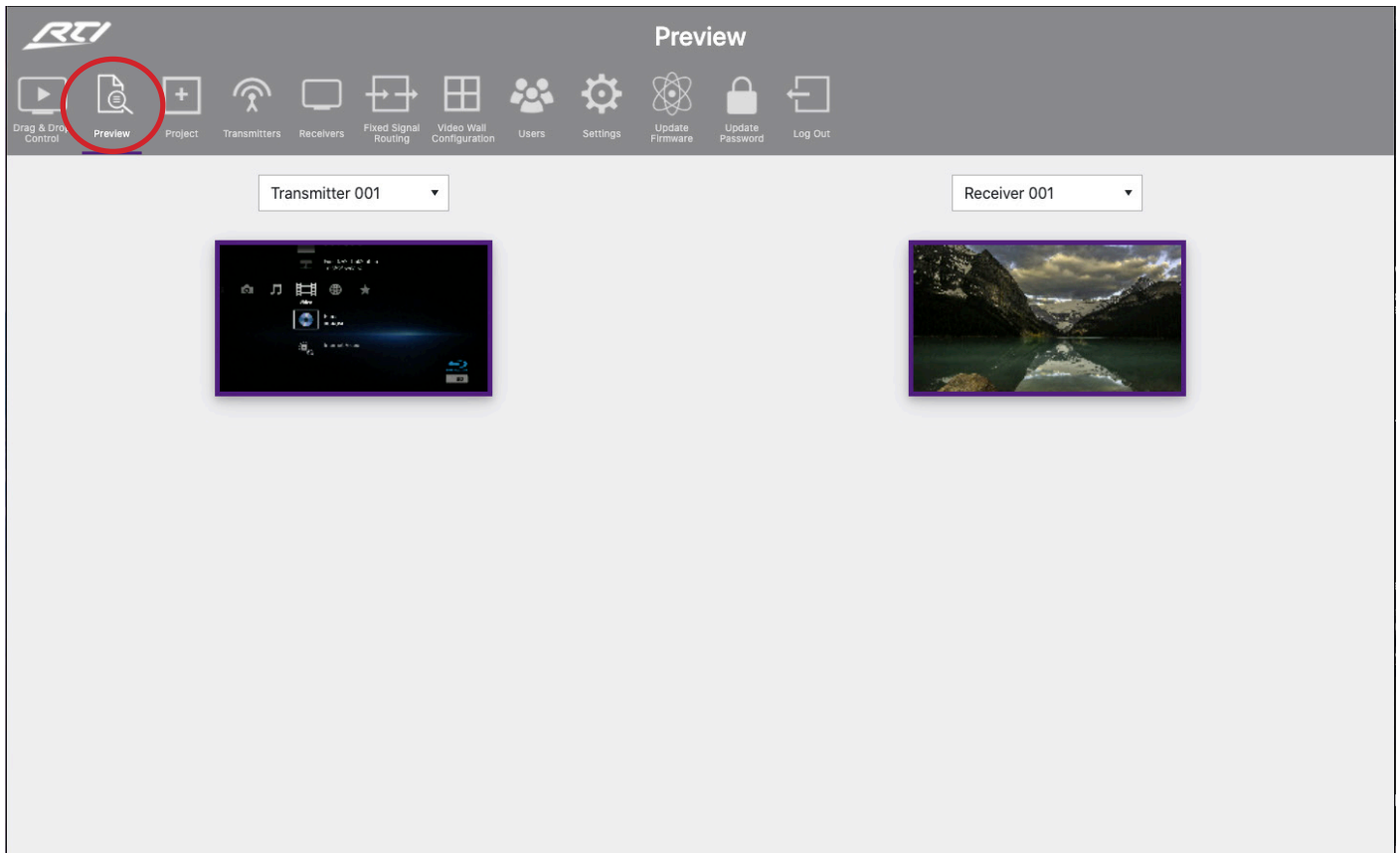

The Preview windows show a live grab of the media which automatically updates every few seconds. To select the Transmitter or Receiver to preview, use the drop down box to select the individual Transmitter or Receiver to preview.

Web-GUI - Project Summary

Outlines the units that are currently set-up in the VIP system as an overview, or for scanning the network for new devices to assign to the project:

Current Devices Toggle OSD | Export Project | Import Project | Clear Project

Transmitters				Receivers			
ID	Name	IP Address	Status	ID	Name	IP Address	Status
1	Transmitter 001	169.254.3.1	Online	1	Receiver 001	169.254.6.1	Online
2	Transmitter 002	169.254.3.2	Online	2	Receiver 002	169.254.6.2	Online
3	Transmitter 003	169.254.3.3	Online	3	Receiver 003	169.254.6.3	Online
4	Transmitter 004	169.254.3.4	Online	4	Receiver 004	169.254.6.4	Online

Unassigned Devices Assign New Devices | Continuously Scan & Auto Assign | Scan Once

Unassigned Transmitters		Unassigned Receivers	
IP Address	MAC Address	IP Address	MAC Address
There are no unassigned transmitters.		There are no unassigned receivers.	

Options on this page:

- Toggle OSD:** turn On / Off the OSD (On Screen Display). Toggling the OSD On shows the ID number (i.e. ID 001) of the VIP Receiver on each display as an overlay to the media being distributed. Toggling OSD Off removes the OSD (as outlined on page 23).
- Export Project:** create a save file (.json) for the configuration of the system.
- Import Project:** import an already configured project into the current system. This is particularly helpful when setting up a secondary system or expansion to a current system off-site where the two systems can be merged into one.
- Clear Project:** clears the current project.
- Continuously Scan & Auto Assign:** continuously scan the network and auto assign new VIP devices to the next available ID and IP address as connected. If only connecting ONE new unit, use the 'Scan Once' option - the VIP-UHD-CTRL will continue to scan the network for new VIP devices until found, or select this button again to stop the scan.
- Scan Once:** scan the network once for any new VIP devices connected, and then be presented with a pop up to either manually assign the new device, or auto assign a new unit to the next available ID and IP address as connected.

Web-GUI - Transmitters

The Transmitter summary page is an overview of all Transmitter devices that have been configured within the system, with the ability to update the system as required.

ID	Name	IP Address	MAC Address	Firmware	Status	EDID	Audio Selection
1	Transmitter 001	169.254.3.1	34:D0:B8:21:1A:57	A1.8	Online	Default EDID	HDMI
2	Transmitter 002	169.254.3.2	34:D0:B8:21:1B:CD	A1.8	Online	Default EDID	HDMI
3	Transmitter 003	169.254.3.3	34:D0:B8:21:1B:E4	A1.8	Online	Default EDID	HDMI
4	Transmitter 004	169.254.3.4	34:D0:B8:21:1B:2E	A1.8	Online	Default EDID	HDMI

Features of the Transmitter summary page include:

- ID / Input** - the ID / Input number is used for control of the VIP system when using third party drivers.
- Name** - the name of the Transmitter (typically the device attached to the Transmitter).
- IP Address** - the IP address assigned to the Transmitter during configuration.
- MAC Address** - shows the unique MAC address of the Transmitter.
- Firmware** - displays the firmware version currently loaded onto the Transmitter. For more information on firmware updating, please see 'Update Devices' on page 47.
- Status** - shows the online / offline status of each Transmitter. Should a product show as 'Offline', check the units connectivity to the network switch.
- EDID** - fix the EDID value for each Transmitter (source). This is used to request specific video and audio resolutions for the source device to output. Basic help can be obtained on EDID selection by clicking the button at the top of the page marked 'EDID Help'. EDID selections as follows:
 - Default EDID - the default EDID is to request a 1080p / 2ch signal from the source device
 - 1080i @ 60Hz 2ch
 - 1080i @ 60Hz 5.1ch
 - 1080i @ 60Hz 7.1ch
 - 1080p @ 60Hz 2ch
 - 1080p @ 60Hz 5.1ch
 - 1080p @ 60Hz 7.1ch
 - 1080p @ 60Hz / 3D 2ch
 - 1080p @ 60Hz / 3D 5.1ch
 - 1080p @ 60Hz / 3D 7.1ch
 - 4K2K 4:2:0 2ch
 - 4K2K 4:2:0 5.1ch
 - 4K2K 4:2:0 7.1ch
 - 4K2K 4:4:4 2ch
 - 4K2K 4:4:4 5.1ch
 - 4K2K 4:4:4 7.1ch
 - DVI 1280 x 1024 @ 60Hz (no audio)
 - DVI 1920 x 1080 @ 60Hz (no audio)
 - DVI 1920 x 1200 @ 60Hz (no audio)
- Audio Selection** - selects either original HDMI audio, or replaces the embedded audio with a local analog audio input on the Transmitter. Default setting will be 'Auto'.
- Actions** - opens a pop-up window with advanced configuration settings. See following page for further information.
- Refresh** - refresh all current information on the devices within the system.

Web-GUI - Transmitters - Actions

The 'Actions' button allows for advanced features of the units to be accessed and configured.

1. **Name** - Transmitter names can be amended by entering a name into the free-form text box. **Please note:** this is limited to 16 characters in length, some special characters may not be supported.
2. **Update ID** - the ID of a unit is set as default to the same number as the last 3 digits of the units IP address i.e. Transmitter number 3 is assigned an IP address of 169.254.3.3 and will have an ID of 3. Amending the ID of the unit is not normally recommended.
3. **CEC Pass-through (On / Off)** - allows for CEC (Consumer Electronic Command) to be sent through the VIP system to and from the source device connected to the Transmitter. **Please note:** CEC must be enabled on the Receiver unit also for the CEC commands to be sent between. Default setting for this feature is On.
4. **Front Panel Display (On / Off)** - use this to enable / disable the dual 7-segment LED displays on the front of the Transmitter. The front panel display of the VIP unit will time-out after 90 seconds and turn off.
5. **Front Panel Power LED Flash (On / Off / On 90 Seconds)** - will flash the power LED on the front panel of the Transmitter to help identify the product following auto configuration. Options are: flash the power light continuously, or flash the LED for 90 seconds before the LED goes back to being permanently lit. **Please note:** the front panel LED's will time-out after 90 seconds with the front panel display. Press one of the CH buttons to wake the unit.
6. **Copy EDID** - see adjacent page for further information on Copy EDID.
7. **Serial Settings** - turn on serial 'Guest Mode' and set the individual serial port settings for the device (i.e. Baud Rate, Parity etc).
8. **Preview** - displays a pop-up window with live a screen grab of the source device connected to the Transmitter.
9. **Reboot** - reboots the Transmitter.
10. **Replace** - used to replace an offline Transmitter. **Please note:** the Transmitter to be replaced must be offline for this feature to be utilised, and the new Transmitter must be a factory default unit with default IP address: 169.254.100.254.
11. **Remove from Project** - removes the Transmitter device from the current project.
12. **Factory Reset** - restores the Transmitter to its original default settings and sets the IP address to: 169.254.100.254.

Web-GUI - Transmitters - Actions - Copy EDID

EDID (Extended Display Identification Data) is a data structure that is used between a display and a source. This data is used by the source to find out what audio and video resolutions are supported by the display then from this information the source will discover what the best audio and video resolutions need to be output.

While the objective of EDID is to make connecting a digital display to a source a simple plug-and-play procedure, issues can arise when multiple displays, or video matrix switching is introduced because of the increased number of variables.

By pre-determining the video resolution and audio format of the source and display device you can reduce the time need for EDID hand shaking making switching quicker and more reliable.

The Copy EDID function allows the EDID of a display to be grabbed and stored within the VIP-UHD-CTRL. The EDID configuraiton of the screen can be recalled within the EDID selection of the Transmitter. The displays EDID can then be applied to any source device not displaying correctly on the screen in question.

It is recommended to ensure that the media from the Transmitter with the custom EDID displays correctly on other displays within the system.

Please note: it is important that only one screen is viewing the Transmitter at the time the EDID Copy takes place.

Update Transmitter 001

Name

CEC Pass-through ON

Front Panel Display (ON = Permanent, OFF = 90 Second time-out) OFF

Front Panel Power LED Flash

Copy EDID

The

Web-GUI - Receivers

The Receiver summary window gives an overview of all the Receiver devices that have been configured within the system, with the ability to update the system as required.

ID	Name	IP Address	MAC Address	Firmware	Status	Source	Scaler Resolution	HDR	Function
1	Receiver 001	169.254.6.1	34:D0:B8:21:1C:F6	A1.8	Online	Transmitter 003	Pass Through	On	Matrix
2	Receiver 002	169.254.6.2	34:D0:B8:21:1D:F6	A1.8	Online	Transmitter 003	Pass Through	On	Matrix
3	Receiver 003	169.254.6.3	34:D0:B8:21:1C:3E	A1.8	Online	Transmitter 003	Pass Through	On	Matrix

Features of the Receiver summary page include:

- ID / Output** - the ID / output number is used for control of the VIP system when using third party drivers.
- Name** - the name of the Receivers (typically the device attached to the Receiver) are automatically assigned default names i.e. Receiver 001 etc. Receiver names can be amended within the Device Setup page (within the Wizard), or by clicking on the 'Actions' button for an individual unit - see next page.
- IP Address** - the IP address assigned to the Receiver during configuration.
- MAC Address** - shows the unique MAC address of the Receiver.
- Firmware** - displays the firmware version currently loaded onto the Receiver. For more information on updating firmware, please see 'Update Devices'.
- Status** - shows the online / offline status of each Receiver. Should a product show as being 'Offline', check the units connectivity to the network switch.
- Source** - shows the current source selected at each Receiver. To switch source selection, choose a new Transmitter from the drop-down selection.
- Resolution** - adjust the output resolution using the built-in video scaler inside the VIP Receiver. The scaler is capable of both upscaling and downscaling the incoming video signal. Output resolutions include:
 - Pass Through - will output the same resolution that the source is outputting (up to 4K 30Hz max)
 - 2160p @ 30Hz
 - 2160p @ 24Hz
 - 1080p @ 60Hz
 - 1080p @ 50Hz
 - 720p @ 60Hz
 - 720p @ 50Hz
 - 1280x1024 @ 60Hz
 - 1024x768 @ 60Hz
 - 1360x768 @ 60Hz
 - 1440x900 @ 60Hz
 - 1680x1050 @ 60Hz
- HDR On/Off** - turns on HDR (High Dynamic Range) compatibility - only use with screens that support HDR. Limited to static HDR formats only.
- Function** - identifies the Receiver as a standalone product (Matrix) or as part of a Video Wall.
- Actions** - see next for breakdown of additional actions options
- Scaling Help** - you can obtain some basic help with scaling selection by clicking the button at the top of the page marked 'Scaling Help'.
- Refresh** - click here to refresh all current information on the devices within the system.

Web-GUI - Receivers - Actions

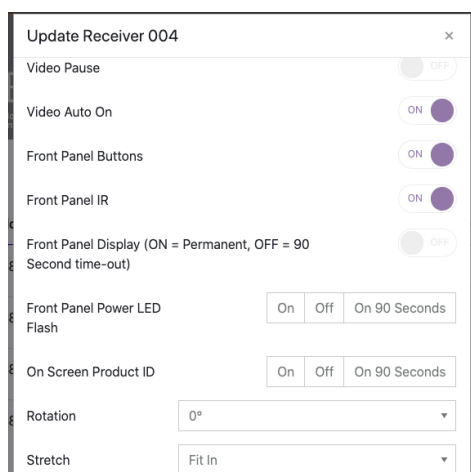

The 'Actions' button allows for advanced features of the Receiver to be accessed and configured.

1. **Name** - can be amended by entering a name into the free-form text box. **Please note:** this is limited to 16 characters in length, some special characters may not be supported.
2. **Update ID** - the ID is set as default to the same as the last 3 digits of the device IP address i.e. Receiver 3 is assigned an IP address of 169.254.6.3 and will have an ID of 3. Update ID allows you to amend the ID of the unit (*not recommended*).
3. **Fast Switching** - switches the video first, with audio, IR, RS-232, USB switched after. **Please note:** whilst the video feed may switch faster, other parts of the feed (i.e. audio, IR etc) may take slightly longer.
4. **CEC Pass-through (On / Off)** - allows for CEC to be sent through the VIP system to and from the display device connected to the Receiver. CEC must also be enabled on the Transmitter.
5. **Front Panel Buttons (On / Off)** - the Channel buttons on the front of each Receiver can be disabled to stop unwanted switching or manual configuration once the Receiver have been configured.
6. **Front Panel IR (On / Off)** - enables / disables the Receiver from accepting IR commands.
7. **On Screen Product ID (On / Off / 90 Seconds)** - turn On / Off the On Screen Product ID (OSD). Toggling the On Screen Product ID On shows the ID number (i.e. ID 001) of the Receiver on each display connected to the device as an overlay to the media being distributed. If 90 Seconds is selected, the OSD displays for 90 seconds. Toggling On Screen Product ID Off removes the OSD.
8. **Front Panel Power LED Flash (On / Off / On 90 Seconds)** - will flash the power LED on the front panel of the Receiver to help identify the product. Options are to flash the power light continuously, or to flash the LED for 90 seconds before the LED goes back to being permanently lit. Please note: the front panel LED's will automatically time-out after 90 seconds with the front panel display. Simply press one of the CH buttons to wake up the unit.
9. **Front Panel Display (On / 90 Seconds)** - enable / disable the dual 7-segment LED display on the front of the Receiver. The front panel display of the device will automatically time-out after 90 seconds until woken.
10. **Rotation** - rotate the image by: 0, 90, 180 and 270 degrees.
11. **Stretch** - re-sizes the image to 'Stretch' to the aspect of the display, or 'Maintain Aspect Ratio' of the source device output.
12. **Serial Settings** - enable serial 'Guest Mode' and set the serial port settings for the device
13. **Preview** - displays a pop-up window with live screen grab of the source device connected to the Transmitter. The screen grab refreshes every 2 seconds.
14. **Reboot** - reboots the Receiver.
15. **Replace** - used to replace an offline Receiver. Please note: the unit to be replaced must be offline for this feature to be utilised, and the new Receiver must be a factory default unit with IP address: 169.254.100.254.
16. **Remove from Project** - removes the Receiver from the project. Does not apply factory default settings.
17. **Factory Reset** - restores the Receiver to it's original default settings and sets the default IP address to: 169.254.100.254.

Web-GUI - Fixed Signal Routing

The VIP-UHD-CTRL is capable of advanced independent routing of the following signals via the VIP system:

- Video
- Audio
- InfraRed (IR)
- RS-232
- USB / KVM
- CEC (Consumer Electronic Command)

This allows each signal to be fixed from one VIP product to another and not be affected by standard video switching. This can be useful for IR, CEC or RS-232 control of products in the field using the VIP system to extend control commands.

Please note: with the exception of IR and RS-232, routing can only be fixed from a Receiver to a Transmitter product. Although routing can only be set up one way, the communication is bi-directional between the two products.

ID	Name	IP Address	Video	Audio	IR	Serial	USB	CEC
1	Receiver 001	169.254.6.1	Follow	Follow	Follow	Follow	Follow	Follow
2	Receiver 002	169.254.6.2	Follow	Follow	Follow	Follow	Follow	Follow
3	Receiver 003	169.254.6.3	Follow	Follow	Follow	Follow	Follow	Follow
4	Receiver 004	169.254.6.4	Follow	Follow	Follow	Follow	Follow	Follow

By default, the routing of: Video, Audio, IR, Serial, USB and CEC will automatically follow the Transmitter selection of the Receiver unit.

To select a fixed route, use the drop down box for each of the individual signals / Receivers to fix a route.

Once a VIP-UHD-CTRL has been added into a VIP system, the IR switching control abilities (not IR pass-through) and the front panel CH buttons of the VIP Receivers are enabled by default. This is disabled from the Actions function contained within the Receiver summary page - see previous page.

Routing can be cleared by selecting 'Follow' at any point from the web-GUI. More information on Fixed Routing can be found by clicking 'Fixed Routing Help'.

For advanced routing commands for Video, Audio, IR, RS-232, USB and CEC, please refer to the API section at the rear of this manual.

Fixed Routed Audio

The VIP-UHD-CTRL allows for the audio component of a HDMI signal to be routed independently throughout the RTI VIP system. Under normal operation the embedded audio within a HDMI signal will be distributed with the associated video signal from Transmitter to Receiver/s.

The fixed audio routing capabilities of the VIP-UHD-CTRL allow for the audio track from one source to be embedded onto another Transmitters video stream.

Fixed Routed IR

The fixed IR routing feature allows a fixed bi-directional IR link between 2x VIP products. This can be useful for sending IR from a centrally located controller using the VIP system as a method of extending IR out to a display or another product in the system. The IR link is bi-directional so can also be sent back the opposite way at the same time.

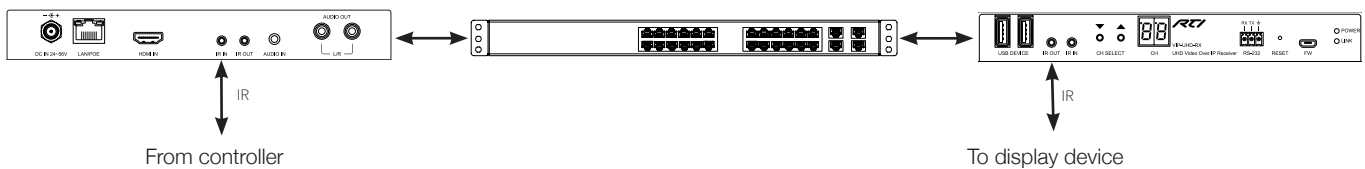

Connections:

The third party control processor IR, or RTI IR receiver, is connected to the IR RX socket on the VIP-UHD Transmitter or Receiver.

Please note: You must use RTI 12V Receiver or RTI IR Control Cable (3.5mm stereo to mono converter cable). RTI InfraRed products are all 12V and **NOT** compatible with alternative manufacturers InfraRed solutions.

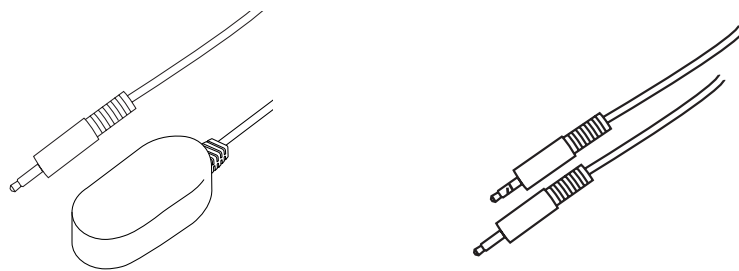

The RTI 12V Emitter is connected to the IR OUT socket on the VIP Transmitter or Receiver. The RTI Emitters are designed for discrete IR control of hardware.

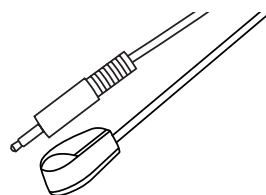

Fixed Routed USB / KVM

The fixed USB routing feature allows a fixed USB link between a VIP Receiver/s and a Transmitter. This can be useful for sending KVM signals between a users position to a centrally located PC, server, CCTV DVR / NVR etc.

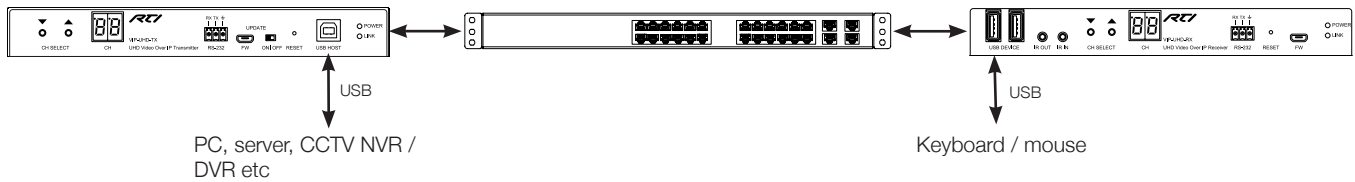

USB Specifications:

USB Specification	USB2.0
Extension	Over IP, Hybrid redirection technology
Distance	100m
Distance Ext.	via Ethernet switch hub
Max Downstream Devices	5
Topology	1 to 1 1 to many exclusively (USB oIP) 1 to many simultaneously but limited number of USB devices (USB oIP)* 1 to many simultaneously Keyboard / Mouse (K/M oIP)
USB R/W Performance *	R: 69.6 Mbps W: 62.4 Mbps

* Benchmark Reference: Read / Write USB to SATA HD without VIP system R: 161.6 Mbps / W: 161.6 Mbps

Fixed Routed CEC

CEC or Consumer Electronic Command is a HDMI embedded control protocol that allows for commands to be sent from one HDMI device to another for simple actions such as: Power, Volume etc.

The RTI VIP system allows for the CEC channel within the HDMI link between two products (source and sink) to communicate with eachother using the CEC protocol.

CEC must be enabled (this is sometimes referred to as 'HDMI Control') on both the source device and the display device in order for the VIP system to communicate the CEC commands over the link.

Please note: the RTI VIP system will only transport the CEC protocol transparently. It is advisable to ensure that the source and sink devices will communicate effectively before committing to this control type with VIP. Should an issue be experienced with CEC communication between the source and sink directly, this will be mirrored when sending through the VIP system.

Web-GUI - Video Wall Configuration

VIP-UHD Receivers can be configured to be part of a Video Wall array within the VIP-UHD-CTRL. Any VIP system can contain up to 9x Video Wall arrays of differing shapes and sizes. Ranging from 1x2 up to 9x9.

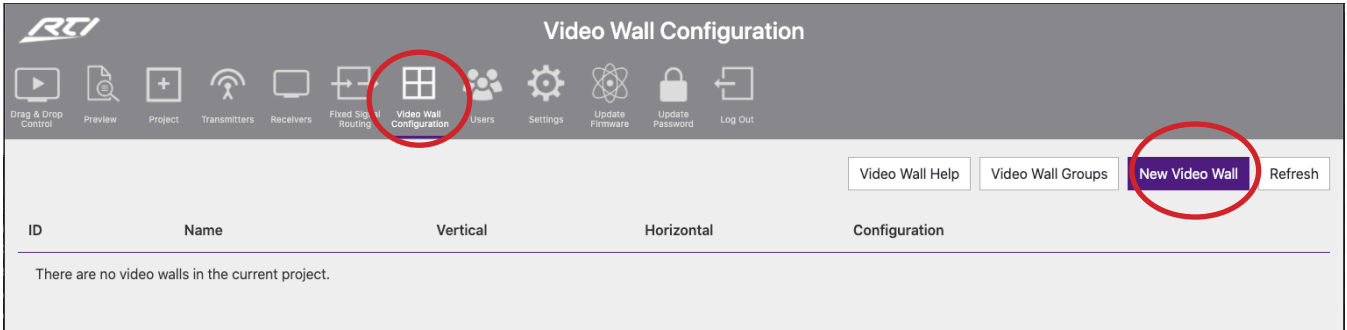

To configure a new Video Wall array, navigate to the Video Wall Configuration menu and click the button labelled 'New Video Wall' as marked at the top of the screen. Help with creating a Video Wall array can be found by clicking the button marked 'Video Wall Help'.

Please note: the VIP Receivers that will be used for the Video Wall should have been configured as individual Receivers before proceeding past this point. It is good practice to have already named the VIP Receivers for ease of configuration i.e. "Video Wall 1 - Top Left".

Create Video Wall ×

Video Wall ID:

Name:

Horizontal:

Vertical:

Enter the relevant information into the pop-up window to name and select the number of panels both horizontally and vertically within the Video Wall array. Once the correct information has been inserted onto the screen, select 'Create' to create the Video Wall array template within the VIP-UHD-CTRL.

Web-GUI - Video Wall Configuration - continued...

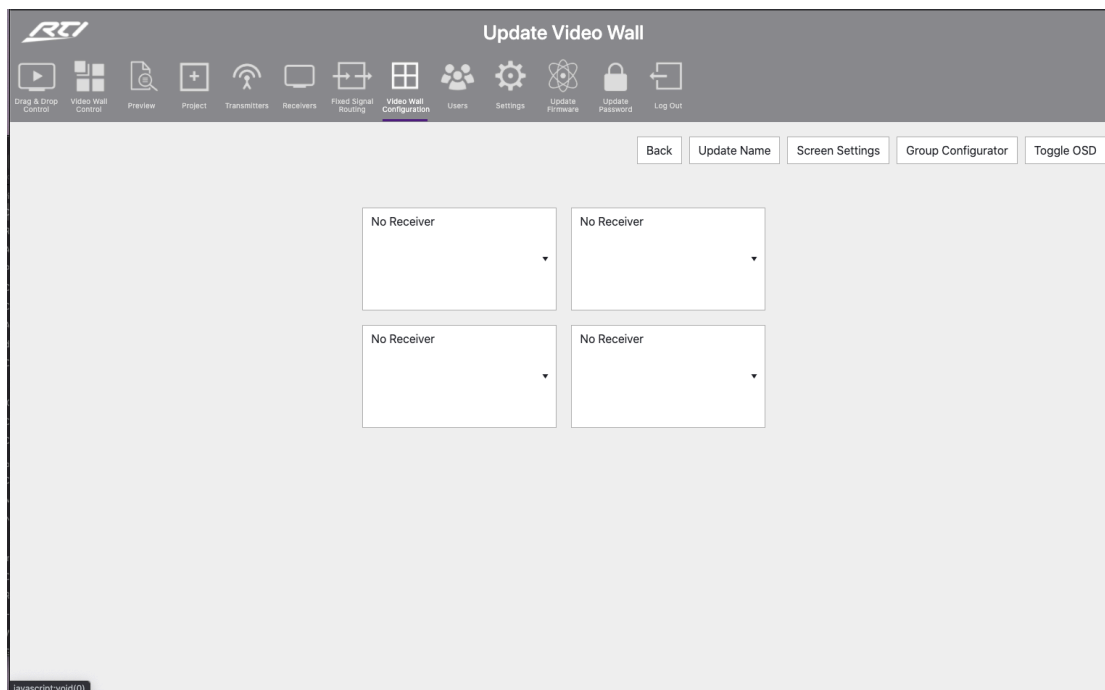

The menu page for the new Video Wall array has the following options:

1. **Back** - returns to the previous page for creating a new Video Wall.
2. **Update Name** - amend the name given to the Video Wall array.
3. **Screen Settings** - adjustment of bezel / gap compensation of the screens being used. See next page for more details on Bezel settings.
4. **Group Configurator** - there are options to be able to create multiple configurations (or 'presets') for each Video Wall array within the VIP system. The grouping / preset allows for the Video Wall to be deployed in multiple ways i.e. grouping different numbers of screens together to create different sized walls within a single array.
5. **Toggle OSD** - turn On / Off the OSD (On Screen Display). Toggling the OSD On will show the ID number (i.e. ID 001) of the Multicast Receiver on each display connected to the Receiver as an overlay to the media being distributed. Toggling OSD Off removes the OSD. This allows easier identification of displays within a Video Wall during configuration and setup.

Display / Receiver Assign:

The VIP-UHD-CTRL will create a visual representation of the Video Wall onto the page. Use the drop down arrows for each screen to select the relevant VIP Receiver product connected to each screen on the Video Wall array.

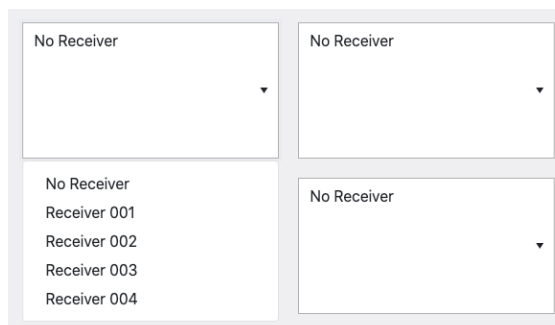

Web-GUI - Video Wall Configuration - Bezel Settings

This page allows for the compensation for the size of each screen bezel within the Video Wall, or alternatively for any gaps inbetween screens. By default, the VIP system will insert the bezels of the Video Wall screens “inbetween” the overall image (splitting the image). This will mean that the bezels of the screens do not sit “over” any part of the image. By adjusting the Outer Width (OW) vs View Width (VW), and the Outer Height (OH) vs View Height (VH), the screen bezels can be adjusted to sit “on top” of the image that is being displayed.

All units are by default 1,000 - this is an arbitrary number. It is recommended to use the dimensions of the screens being used in mm. To compensate for bezel size of the screens being used, reduce the View Width and View Height accordingly to compensate for the size of the bezels. Once the outcome of the corrections required has been obtained, the 'Copy Bezels to All' button can be used to copy the settings to each display. Click 'Update' to confirm settings and return to the previous Update Video Wall screen.

The 'Bezel Help' button opens a pop-up window with guidance to the correction and adjustment of these settings.

Web-GUI - Video Wall Configuration - Group Config.

Once the Video Wall array has been created, it can be configured for different display options. The Video Wall Configurator allows for presets to be created for deploying the Video Wall to adjust for different groups of images across the array. Click the 'Group Configurator' button from the Update Video Wall screen.

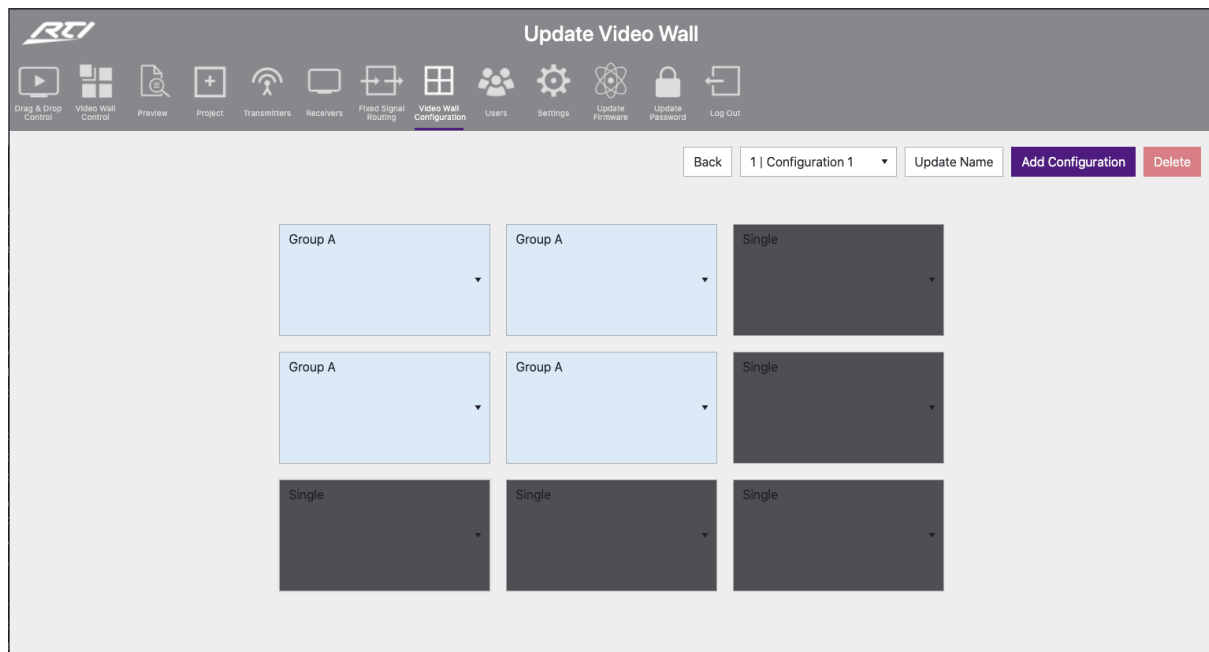

Options within this menu as follows:

1. **Back** - navigates back to the Update Video Wall page without making any changes to the set-up.
2. **Configuration Dropdown** - move between different configurations / presets previously set-up for the Video Wall array. By default, 'Configuration 1' will be inserted for a Video Wall being created and configured for the first time.
3. **Update Name** - set the name of the configuration / preset i.e. 'Single Screens' or 'Video Wall'. By default, configuration / preset names will be set as 'Configuration 1, 2, 3...' until changed.
4. **Add Configuration** - adds a new configuration / preset for the selected Video Wall.
5. **Delete** - removes the currently selected configuration.

Web-GUI - Video Wall Configuration - Group Config.

Group Assign:

There are options to create multiple configurations for each Video Wall array within a VIP system. The grouping allows for the Video Wall to be deployed in multiple ways i.e. grouping different numbers of screens together to create different sized Video Walls within an overall array. Use the dropdown selection for each screen to create a group:

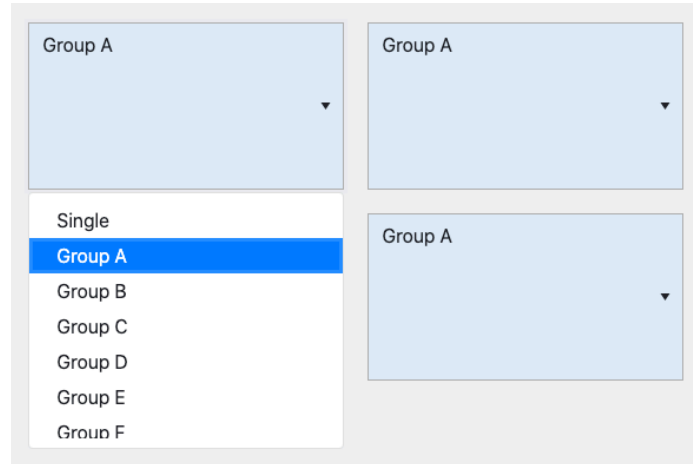

For example: a 3x3 Video Wall array can have multiple configurations / presets:

- For displaying 9x different source media streams - so that all screens work independently with each individual screen showing a single source - not grouped (leave all dropdowns as 'Single').
- As a 3x3 Video Wall - displaying one source media stream across all 9 screens (all screens need to be selected as 'Group A').
- For displaying a 2x2 Video Wall image within the overall 3x3 Video Wall array. This can have 4x different options:
 - With the 2x2 in the top left of the 3x3, with 5x individual screens to the right and bottom (select the 2x2 in the top left as Group A with other screens set as 'Single') - see example below...
 - With the 2x2 in the top right of the 3x3, with 5x individual screens to the left and bottom (select the 2x2 in the top right as Group A with other screens set as 'Single').
 - With the 2x2 in the bottom left of the 3x3, with 5x individual screens to the right and top (select the 2x2 in the bottom left as Group A with other screens set as 'Single').
 - With the 2x2 in the bottom right of the 3x3, with 5x individual screens to the left and top (select the 2x2 in the bottom right as Group A with other screens set as 'Single').

With the above example, there would be the need to create 6 different configurations for the Video Wall array, allocating the grouped screens to a Group using the selection dropdown. The Configurations / Groups can be renamed as required using the 'Update Name' option in the Group Configuration screen.

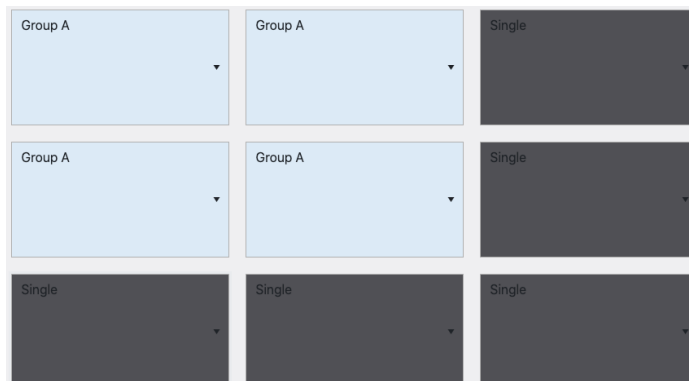

Web-GUI - Video Wall Configuration

Once the Video Wall has been created, named accordingly, and groups / presets have been assigned, the configured Video Wall can be viewed from the main Video Wall Configuration page:

ID	Name	Vertical	Horizontal	Configuration
1	Video Wall 1	2	2	Configuration 1
2	Video Wall 2	3	3	Configuration 1

Configurations / presets that have been designed within the system will now appear within the Video Wall Groups page. The Video Wall Configuration page allows for a group to be switched.

The 'Refresh' button refreshes the current page and the configuration of the Video Wall array currently being displayed. This is particularly helpful when testing Video Wall configuration commands from a control system.

Please see the advanced API commands for use with control systems for Video Wall control, Configuration switching and Group selection towards the rear of this guide.

Web-GUI - Users

The VIP-UHD-CTRL has the ability for individual Users to log into the web-GUI of the VIP system and access individual parts / zones of the system, for full, or simple control of which source is being watched in selected locations only. For assistance setting up new Users, click on the button marked 'Users Help'.

To setup a new User, click 'New User' at the top of the screen:

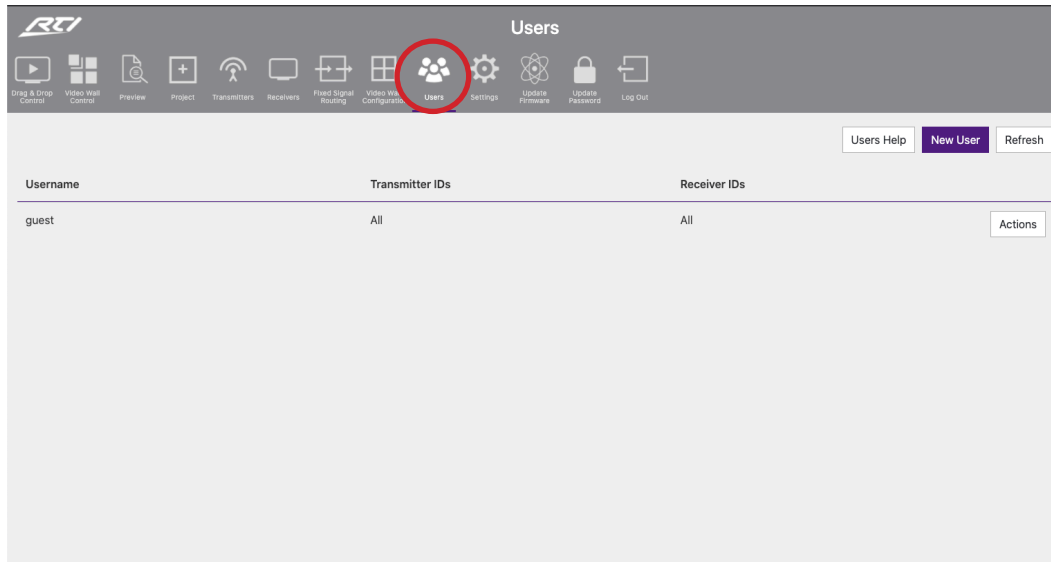

Enter the new User credentials into the window that appears and click 'Create' once completed:

Create User ✕

Username

Password

Confirm Password

Any new Users added will then appear listed in the Users menu page ready for access / permissions to be configured per User.

Web-GUI - Users - continued...

To select individual User permissions, update the User password, or to remove the User from the VIP system, click the 'Actions' button.

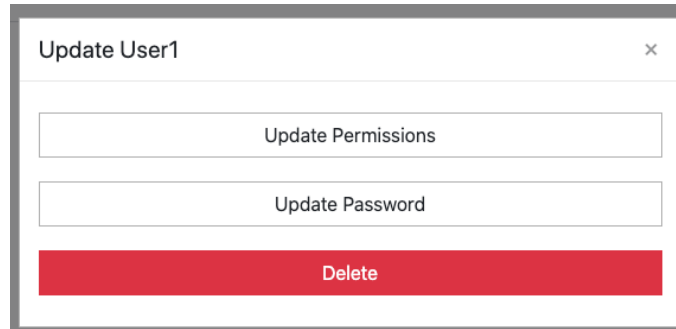

The Permissions option gives access to select which Transmitters or Receivers the User can see within their control pages (Drag & Drop Control, and Video Wall Control). With all boxes checked next to each Transmitter or Receiver, the User can preview and switch across the entire system. If the User is only to be able to control one screen / receiver, then uncheck all other Receivers. Likewise, if the User is not to be given access to one (or more) source devices, these Transmitters should be unchecked.

Where there is a Video Wall array in the VIP system, a User will need access to **ALL** associated Receivers to be able to gain switching control of the Video Wall. If the User does not have access to all Receivers, the Video Wall will not appear in the Video Wall Control page.

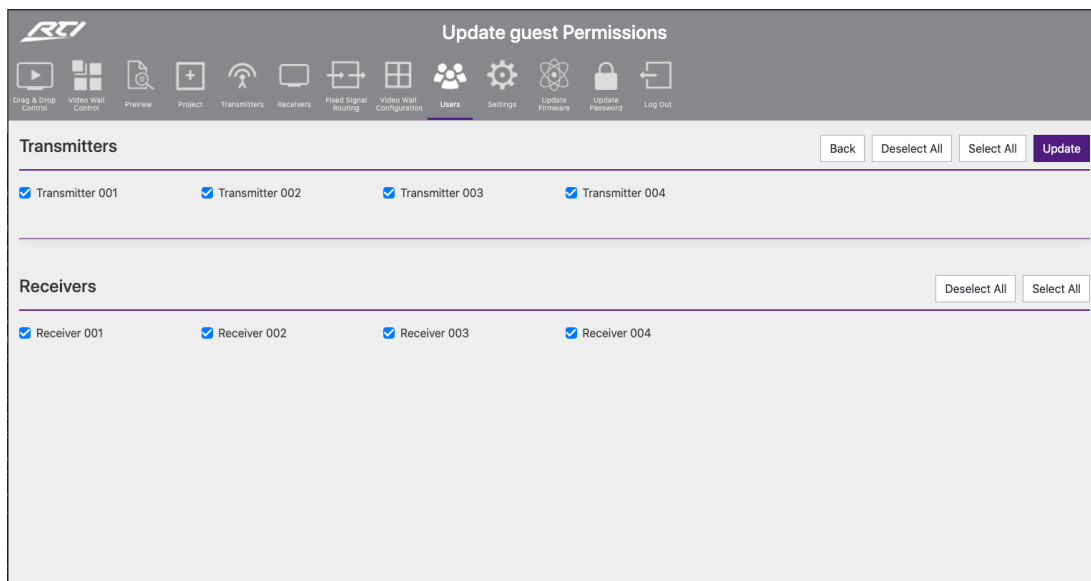

Once the User permissions have been selected, click 'Update' to apply the settings.

Please note: in order to stop non-secure access to the web interface (i.e. with no password), the 'Guest' account must be deleted after a new user with access to the sources / screens applicable set-up. This way, any User of the system is required to enter a password to gain switching control of the system.

Web-GUI - Settings

The Settings page of the VIP-UHD-CTRL will provide an overview of the general settings, and control / video network settings of the unit with the ability to amend and update the unit accordingly.

Settings

Name	VIP-UHD-CTRL	Version	1.82	GUI Version	20201102.1
IR Control	On	Telnet Port	23	RS232 Baud Rate	57600

Control Network

DHCP	Enabled	IP Address	192.168.1.107	Subnet	255.255.255.0
Gateway	192.168.1.1	MAC Address	34:D0:B8:20:1C:61		

Video Network

IP Address	169.254.2.225	Subnet	255.255.0.0	Gateway	169.254.2.1
MAC Address	34:D0:B8:20:1C:60				

The 'Clear Project' removes all Transmitters, Receivers, Video Walls and Users that have been created from the current project file contained within the VIP-UHD-CTRL. Confirm by selecting 'Yes'.

Please note: the New Project Setup Wizard will appear after using the 'Clear Project' function. Should a project save file not have been created prior to clearing the project, it is not possible to restore the system after this point.

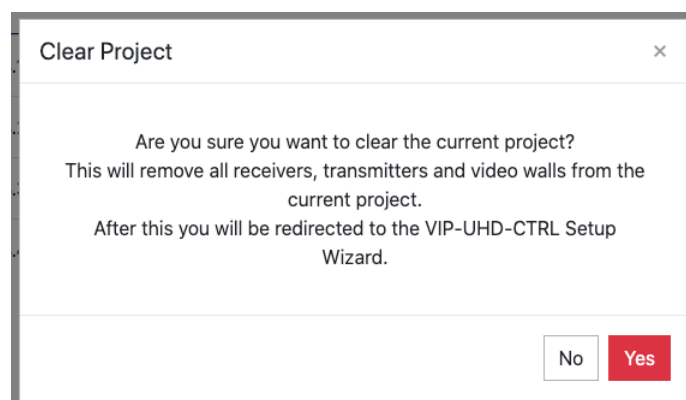

Web-GUI - Settings - continued...

The 'Reset VIP-UHD-CTRL' option allows for the following:

1. Reset System to factory default (*excludes Network settings*)
2. Reset Network to default settings (*excludes System settings*)
3. Reset ALL System and Network settings back to factory default

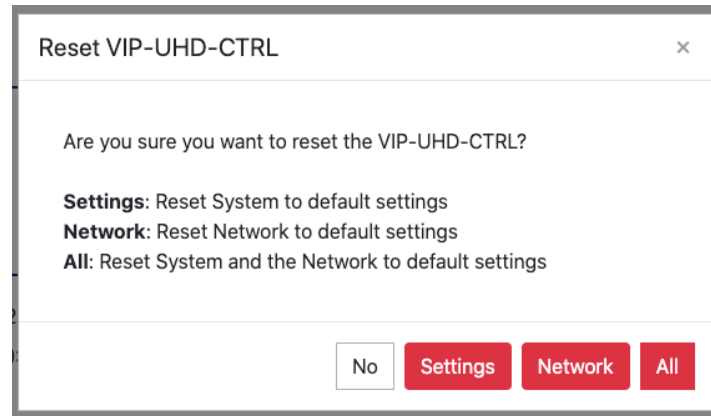

Under general settings, the 'Update' option allows for the following:

1. Turn On / Off IR control to enable / disable the IR input of the VIP-UHD-CTRL from accepting IR commands from a control solution.
2. Update the Telnet port number that the Control port of the VIP-UHD-CTRL communicates through. The default port number used is port 23.
3. Update the RS-232 Baud Rate of the DB9 connection of the VIP-UHD-CTRL to suit the control processor. The default Baud Rate used is: 57600.

The IP addresses of the two RJ45 ports on the VIP-UHD-CTRL can be updated with individual IP, Subnet and Gateway addresses. Use the 'Update' button for either the Control Network or Video Network to update the information for the ports required. The Control Port can be set to DHCP by selecting 'On':

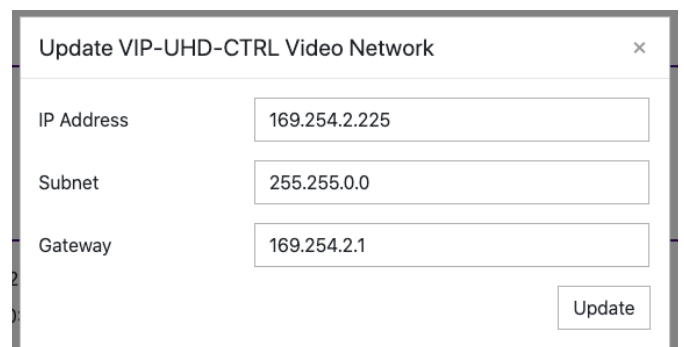
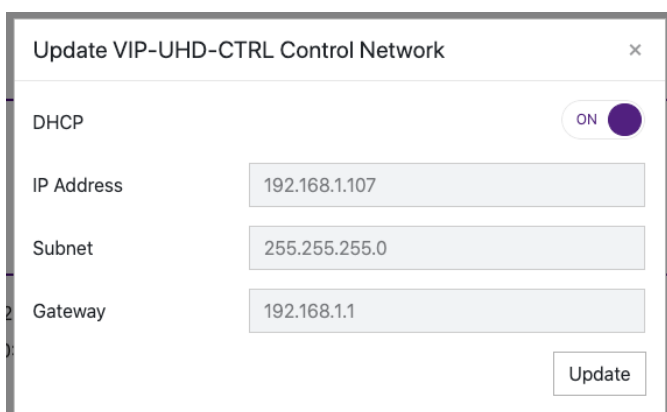

IMPORTANT: Amending the Video Network IP Address out of the 169.254.x.x range will stop communication between the VIP-UHD-CTRL and the VIP-UHD Transmitters and Receivers that have been pre-configured. Whilst the VIP-UHD-CTRL can be moved out of the recommended range, the IP addresses of ALL Transmitters and Receivers would need to be amended to be in the same IP range to ensure connectivity and control of the VIP system. **This is not recommended.**

Web-GUI - Update Firmware

The Update Firmware page allows for the firmware updating of:

- VIP-UHD-CTRL unit
- VIP-UHD Transmitter and Receiver units

Please note: firmware packages for the VIP-UHD-CTRL, VIP-UHD Transmitter and Receiver products are individual. It is recommended that firmware updating is only completed from a desktop or laptop PC that is hard-wired into the network.

Updating the VIP-UHD-CTRL:

Download the VIP-UHD-CTRL firmware file (.bin) from the RTI website to your computer.

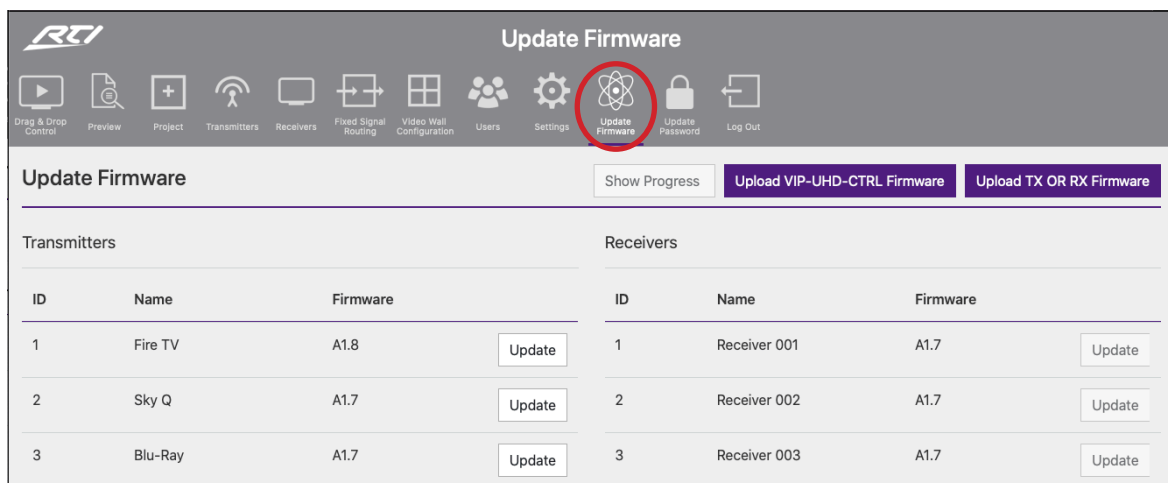

Click on the button marked 'Upload VIP-UHD-CTRL Firmware'.

Select the [VIP-UHD-CTRL].bin file downloaded to your computer for the unit. The file will automatically upload to the VIP-UHD-CTRL which takes approximately 2 minutes to complete. The page refreshes to the Drag & Drop page once complete.

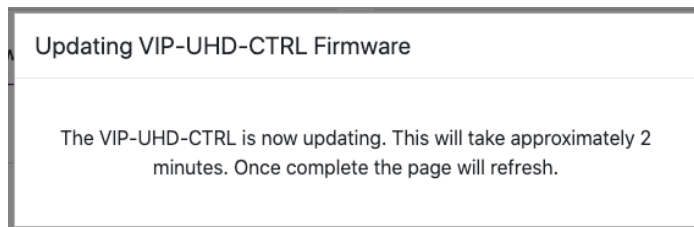

Web-GUI - Update Firmware... continued...

The Update Firmware page is also used for firmware upgrading the firmware of VIP Transmitters or Receivers. The page allows for multiple Transmitter, or, Receiver units to be upgraded. Upgrading is carried out individually per unit.

The most current firmware version for the VIP Transmitters and Receivers can be downloaded from the RTI website.

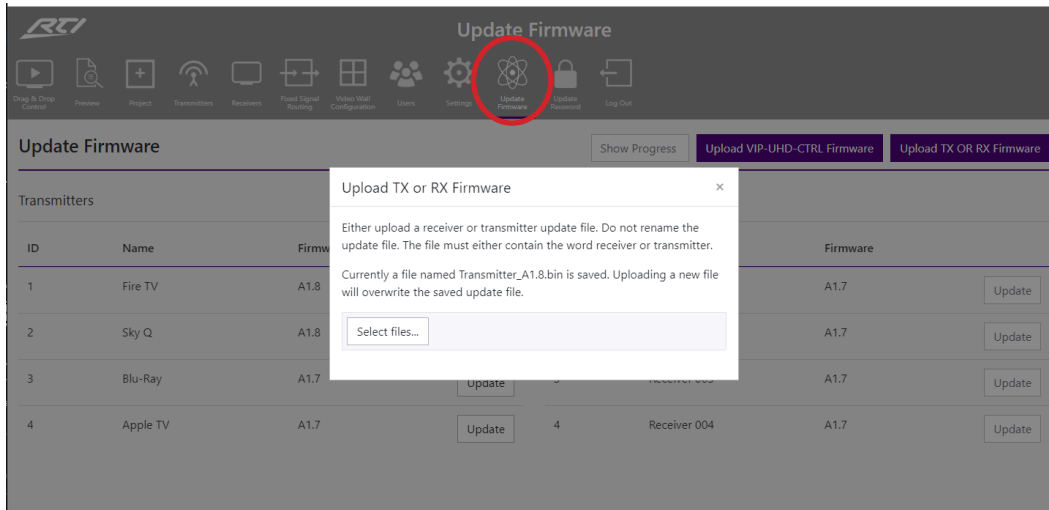

To upload the firmware files, click the button marked 'Upload TX or RX Firmware', then 'Select Files'. Once the correct firmware (.bin) file has been selected from the computer, the firmware will upload to the VIP-UHD-CTRL.

Please note: this part of the upgrade does not upload the firmware into the TX or RX units, it only uploads to the VIP-UHD-CTRL ready for deployment to the TX or RX.

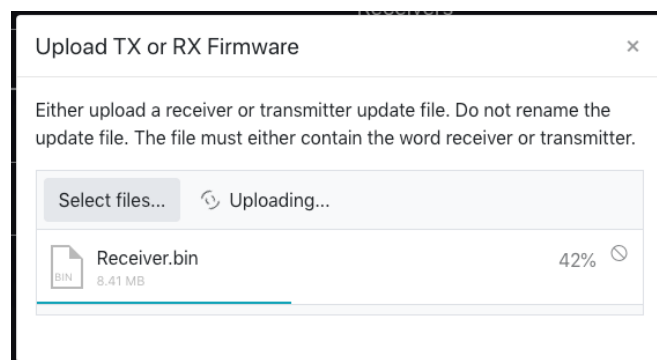

IMPORTANT: Do not close or navigate away from the upload whilst in progress to avoid firmware data being lost during transfer to the VIP-UHD-CTRL.

Web-GUI - Update Firmware... continued...

On completion of the firmware files being uploaded to the VIP-UHD-CTRL, a notification will appear on screen to feedback the success of the upload:

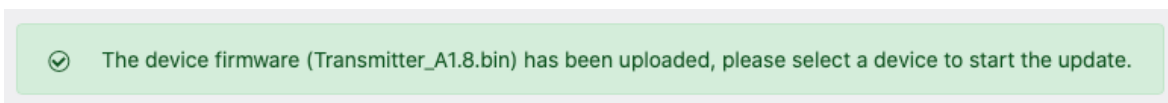

To complete the upgrade of the firmware of either the VIP Transmitter, or for Receiver units, click the button marked 'Update' next to the relevant Transmitter or Receiver. **Please note:** it is only possible to update Transmitters, or Receivers at one time. The firmware upgrade process will then begin:

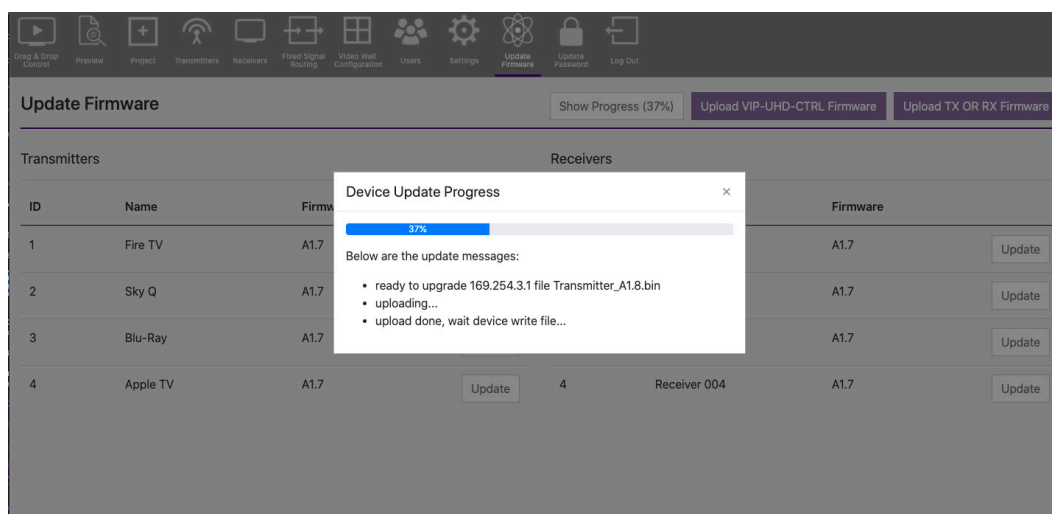

IMPORTANT: Do not disconnect the VIP-UHD-CTRL or VIP-UHD-TX / RX units whilst in the upgrade process is in progress to avoid firmware data being lost during transfer to the individual Transmitter / Receiver devices.

Update Password

The Admin password for the VIP-UHD-CTRL can be updated to an alpha-numeric password by inserting the new credentials in this pop-up menu option. Click 'Update Password' to confirm:

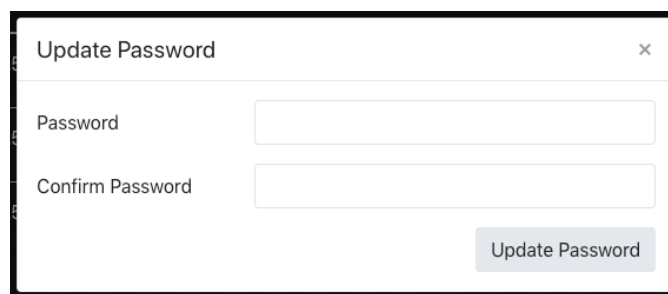

IMPORTANT: Once the Admin password has been changed, it cannot be recovered by the User. If the Admin password is forgotten or lost, please contact a member of the RTI Technical Support team who will be able to assist in the recovery of the Admin rights of the unit.

RS-232 (Serial) Routing

The VIP system features two ways of managing RS-232 command signals:

Type 1 - Fixed Routing:

A static fixed routing for distributing two-way RS-232 commands between a VIP Transmitter to one or multiple Receivers (Fixed Routing). Fixed routing can be left static between two or more products as a permanent connection for the transfer of RS-232 control data, this is configured using the Fixed Routing menu within the VIP-UHD-CTRL.

Type 2 - Guest Mode:

Allows the RS-232 connection of a device to be sent over the IP network (IP / RS-232 command in, to RS-232 out). Guest Mode gives a control system the ability to send an RS-232 or IP command to the VIP-UHD-CTRL and an RS-232 command to be sent out of a Receiver or Transmitter as a result. This IP to RS-232 signalling, allows the control system to have control of as many RS-232 devices as there are Receivers and Transmitters, from the network connection to the VIP-UHD-CTRL.

There are two ways of enabling Guest Mode:

1. Using the VIP-UHD-CTRL web-GUI. See page 19 for enabling Guest Mode on a Transmitter and page 22 for enabling Guest Mode on a Receiver unit.
2. Via the command set as detailed below. The command to configure the connection is: **IN/OUT xxx SG ON**

RS-232 Guest Mode Connection from a Control System:

When using Guest Mode on multiple devices within a system, we would recommend turning Guest Mode on and off when required. This is because a serial command being sent into the VIP-UHD-CTRL will be passed to ALL devices that have Guest Mode enabled.

1. To open a Guest Mode connection between the VIP-UHD-CTRL and a VIP-UHD-TX or RX unit the following command must be sent via IP or RS-232:

INxxxGUEST Connect to TX xxx in Guest Mode from the VIP-UHD-CTRL

OUTxxxGUEST Connect to RX xxx in Guest Mode from the VIP-UHD-CTRL

Example: Transmitter ten is ID 010, meaning 'IN010GUEST' will allow bi-directional Serial / IP commands to be sent between the VIP-UHD-CTRL and Transmitter 10.

2. Once a connection is established, any characters that are sent from the VIP-UHD-CTRL will be transmitted to the connected Transmitter or Receiver, and vice versa.
3. To close the connection send the escape command: 0x02 (02 in Hex). If using Telnet, the connection can also be closed by pressing: CTRL + B.

RTI Infrared Commands

RTI have created 16x input & 16x output IR commands allowing source selection of up to 16x VIP-UHD-TX Transmitters on up to 16x VIP-UHD-RX Receivers. These are different to the source switching controls sent to a VIP Receiver.

For systems larger than 16x source devices (VIP-UHD-TX), please use RS-232 or TCP/IP control.

For the complete database of VIP IR commands, please visit the RTI website, or contact a member of the RTI Technical Support Team.

RS-232 and Telnet Commands

The RTI VIP system can be controlled via serial and TCP/IP. Please refer to the RS-232 connections page towards the start of this manual for settings and pin out. The following pages list all available serial commands for the VIP solution when using the VIP-UHD-CTRL.

Common Mistakes

- Carriage return – Some programs do not require the carriage return where as other will not work unless sent directly after the string. In the case of some Terminal software the token <CR> is used to execute a carriage return. Depending on the program you are using this token maybe different. Some other examples that other control systems deploy include \r or 0D (in hex).
- Spaces – the VIP-UHD-CTRL can work with or without spaces. It simply ignores them. It can also work with 0 to 4 digits. eg: 1 is the same as 01, 001, 0001
 - How the string should look is as follows OUT001FR002
 - How the string may look if spaces are required by the control system: OUT{Space}001{Space}FR002
- Baud Rate or other serial protocol settings not correct

RTI VIP-UHD-CTRL commands and feedback

The following pages list the common API commands that will be required for a control system.

Please note: the maximum number of Transmitters (yyy) and Receivers (xxx) = 762 devices (001-762)

- Receivers (outputs) = xxx
- Transmitters (inputs) = yyy
- Scaler Output = rr
- EDID Input settings = zz
- Baud Rate = br
- GPIO input/output ports = gg

Receiver (Output) Commands

COMMAND DESCRIPTION	COMMAND	RESPONSE
Set OUTPUT:xxx From INPUT:yyy (ALL signals routed)	OUTxxxFRyyy	Set output xxx From INPUT:yyy
Fix VIDEO OUTPUT:xxx From INPUT:yyy	OUTxxxVFRyyy	Set output video xxx From INPUT:yyy
Fix AUDIO OUTPUT:xxx From INPUT:yyy	OUTxxxAFRyyy	Set output audio xxx From INPUT:yyy
Fix IR OUTPUT:xxx From INPUT:yyy	OUTxxxRFRyyy	Set output IR xxx From INPUT:yyy
Fix RS232 OUTPUT:xxx From INPUT:yyy	OUTxxxSFRyyy	Set output RS232xxx From INPUT:yyy
Fix USB OUTPUT:xxx From INPUT:yyy	OUTxxxUFRyyy	Set output usb xxx From INPUT:yyy
Fix CEC OUTPUT:xxx From INPUT:yyy	OUTxxxCFRyyy	Set output cec xxx From INPUT:yyy
Set CEC OUTPUT:yyy ON or Off	OUTxxxCECON/OFF	Set output xxx cec mode ON/OFF
Set OUTPUT:xxx Fast Switching On or Off	OUTxxxFASTON/OFF	Set output xxx fast switching mode ON/OFF
Set OUTPUT:xxx HDR On or Off	OUTxxxHDRON/OFF	Set output xxx hdr mode ON/OFF
Reboot Receiver	OUTxxxRB	Set output xxx reboot and apply all the new config
Rotate Receiver Video Output tt=0: clockwise 0 degree rotate tt=90: clockwise 90 degree rotate tt=180: clockwise 180 degree rotate tt=270: clockwise 270 degree rotate	OUTxxxROTATett	output xxx rotate tt degree
Stretch video Output (keep aspect ratio stretch to fit)	OUTxxxSTRETCHON/OFF	Set output xxx stretch ON/OFF
Switch Receiver (Output) between Matrix and Video Wall mode	OUTxxxMODEMX/VW	Set output xxx to matrix/video wall mode
Set Scaler Output Resolution 0: Bypass 1: 2160p@30 2: 2160p@24 3: 1080p@50 4: 1080p@60 5: 1080i@50 6: 1080i@60 7: 720p@60 8: 720p@50 9: 1280x1024@60 10: 1024x768@60 11: 1360x768@60 12: 1440x900@60 13: 1680x1050@60	OUTxxxRESrr	Set output xxx resolution to bypass (=0) Set output xxx resolution to 2160p@30(=1) ETC
Single Receiver (output) status	OUTxxxSTATUS	(See status example at end of document)

Transmitter (Input) Commands

COMMAND DESCRIPTION	COMMAND	RESPONSE
Set CEC INPUT:yyy ON or Off	INyyyCECON/ OFF	Set input xxx cec mode ON/OFF
Set TX Audio source to HDMI audio	INyyyAUDORG	Set Audio source:xxx to audio select hdmi
Set TX Audio source to Analog	INyyyAUDANA	Set Audio source:xxx audio select analog
Set TX Audio source to Auto	INyyyAUDAUTO	Set Audio source:xxx audio select auto
Reboot Transmitter	INyyyRB	Set output xxx reboot and apply all the new config
Copy EDID Input yyy from Output xxx	EDIDyyyCPxxx	Copy outputxxx edid to input yyy
Set Input: yyy EDID To EDID:zz zz=00: HDMI 1080p@60Hz, Audio 2CH PCM zz=01: HDMI 1080p@60Hz, Audio 5.1CH PCM/DTS/ DOLBY zz=02: HDMI 1080p@60Hz, Audio 7.1CH PCM/DTS/ DOLBY/HD zz=03: HDMI 1080i@60Hz, Audio 2CH PCM zz=04: HDMI 1080i@60Hz, Audio 5.1CH PCM/DTS/ DOLBY zz=05: HDMI 1080i@60Hz, Audio 7.1CH PCM/DTS/ DOLBY/HD zz=06: HDMI 1080p@60Hz/3D, Audio 2CH PCM zz=07: HDMI 1080p@60Hz/3D, Audio 5.1CH PCM/ DTS/DOLBY zz=08: HDMI 1080p@60Hz/3D, Audio 7.1CH PCM/ DTS/DOLBY/HD zz=09: HDMI 4K@30Hz 4:4:4, Audio 2CH PCM zz=10: HDMI 4K@30Hz 4:4:4, Audio 5.1CH DTS/ DOLBY zz=11: HDMI 4K@30Hz 4:4:4, Audio 7.1CH DTS/ DOLBY/HD zz=12: DVI 1280x1024@60Hz, Audio None zz=13: DVI 1920x1080@60Hz, Audio None zz=14: DVI 1920x1200@60Hz, Audio None zz=15: HDMI 4K@30Hz 4:4:4, Audio 7.1CH(Default) zz=16: HDMI 4K@60Hz 4:2:0, Audio 2CH PCM zz=17: HDMI 4K@60Hz 4:2:0, Audio 5.1CH DTS/ DOLBY zz=18: HDMI 4K@60Hz 4:2:0, Audio 7.1CH DTS/ DOLBY/HD	EDIDyyyDFzz	Set input yyy edid with default edid zz
Single Transmitter (input) status	INyyySTATUS	(See status example)

Video Wall Commands

Video wall configurations will be setup in the VIP-UHD-CTRL web GUI

Each video wall setup will include the following:

- Video wall creation = each VIP system can include up to 9x separate video walls (01-09)
- Configuration = individual configurations of screens within a video wall. An example of a configuration would be all screens assigned as a single video wall, all screens configured as individual displays, multiple video walls configured within a larger video wall (video wall groups – see below) (01-09)
- Groups = a video wall group is the ‘Grouping’ of VIP Receivers within a video wall allowing simplified source selection and configuration recall of more than one VIP Receiver at the same time (A-J)

Video Wall 1 Configuration 1

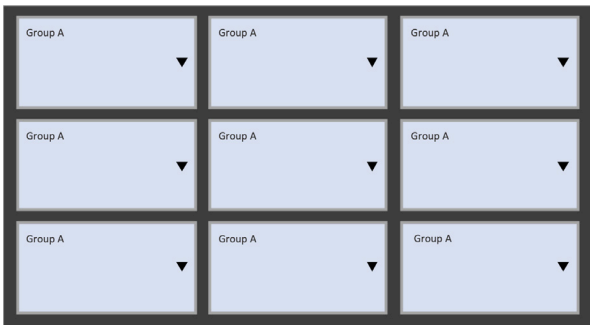

Video Wall 2 Configuration 2

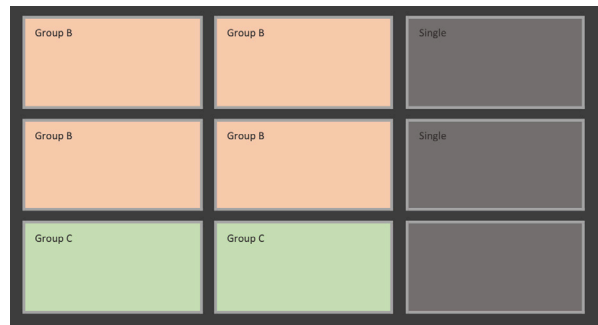

Example of control commands:

- VW01C01APPLY (will apply video wall configuration 1 above to all Receivers)
- VW01C02APPLY (will apply video wall configuration 2 above to all Receivers)
- VW01C01GaFR002 (will apply video configuration 1 and switch all screens to Transmitter 002)
- VW01C02GbFR006 (will apply video configuration 1 and switch group B screens [orange] to Transmitter 006)

When recalling video wall configurations the following applies:

Characters:

- idx = [01...09] - Video Wall Index / Number
- cidx = [01...09] - Config Index / Number
- gidx = [A...J] - Group Index / Number

COMMAND DESCRIPTION	COMMAND	RESPONSE
Apply Config to Video Wall	VW idx C cidx APPLY	Apply config: Configuration cidx
Set Grouped Output from Single Source INPUT:yyy	VW idx C cidx G gidx FR yyy	[SUCCESS] Done
ALL video wall status	VWSTATUS	(See status example at end of document)
Single Video Wall status	VWidxSTATUS	(See status example at end of document)

General VIP-UHD-CTRL Commands

COMMAND DESCRIPTION	COMMAND	RESPONSE
Print all available commands of VIP-UHD-CTRL	HELP	(See HELP summary at end)
Turn IR control port On or Off	IRON/OFF	Set IR ON/OFF
Turn On Serial Guest Mode to Receiver (output) (NOTE: This only puts the RX into Serial Guest mode but doesn't open the connection. Please use command below) br =0: 300 br =1: 600 br =2: 1200 br =3: 2400 br =4: 4800 br =5: 9600 br =6: 19200 br =7: 38400 br =8: 57600 br =9: 115200 bit = Data Bits + Parity + Stop Bits Example: 8n1 Data Bits = [5...8], Parity = [n o e], Stop Bits = [1..2]	OUTxxxSGON/OFF[br] [bit]	Set serial guest mode config done
Serial Guest Mode to Transmitter (input) (details as above)	INxxxSGON/OFF[br][bit]	Set serial guest mode config done
Start Serial Guest Mode To Output ooo	OUT ooo GUEST	(no feedback when in guest mode)
Start Serial Guest Mode To Input ooo	IN ooo GUEST	(no feedback when in guest mode)
Close Serial Guest Mode	CLOSEACMGUEST	[Success] Exit guest
Set IO ports for use as input or output port gg = 0: select all ports gg = 01...04: select single IO port	GPIoggDIRIN/OUT	Set GPIO gg as input/output port
Set IO port to low(0) or high(1) level	GPIoggSET0/1	
Get IO port real input level	GPIoggGET	Get GPIO gg real input level 0/1
IO port status	GPIoggSTATUS	(See status example at end of document)
System status summary	STATUS	(See status example at end of document)
When command fails		<p>unkown param. Type "HELP" for more reference</p> <p>Output xxx does not exist (RX has not been configured)</p> <p>Input yyy does not exist (TX has not been configured)</p> <p>Output xxx is offline</p> <p>Input yyy is offline</p> <p>Param range error (outside of given settings)</p>

Status feedback samples

Command: STATUS

The STATUS feedback gives an overview of the network the VIP-UHD-CTRL is connected to:

=====

IP Control Box VIP-UHD-CTRL Status Info

FW Version: xxx

Power IR Baud

On On 57600

In EDID IP NET/Sig

001 DF009 169.254.003.001 On /On

002 DF016 169.254.003.002 On /On

Out FromIn IP NET/HDMI Res Mode

001 001 169.254.006.001 On /Off 00 VW02

002 002 169.254.006.002 On /Off 00 VW02

LAN DHCP IP Gateway SubnetMask

01_POE Off 169.254.002.225 169.254.002.001 255.255.000.000

02_CTRL Off 010.000.000.225 010.000.000.001 255.255.000.000

Telnet LAN01 MAC LAN02 MAC

0023 34:D0:B8:20:4E:19 34:D0:B8:20:4E:1A

=====

Command: OUT xxx STATUS

The OUT xxx STATUS feedback gives an overview of the output (Receiver: xxx). Including: firmware, mode, fixed routing, name etc.

=====

IP Control Box VIP-UHD-CTRL Output Info

FW Version: xxx

Out Net HPD Ver Mode Res Rotate Name

001 On Off A7.3.0 VW 00 0 Receiver 001

Fast Fr Vid/Aud/IR_/Ser/USB/CEC HDR MCas

On 001 001/004/000/000/002/000 On On

CEC DBG Stretch IR BTN LED SGen/Br/Bit

On On Off On On 3 Off /9/8n1

IM MAC

Static 00:19:FA:00:59:3F

IP GW SM

169.254.006.001 169.254.006.001 255.255.000.000

=====

Status feedback samples

Command: IN xxx STATUS

An overview of the input (Transmitter: xxx). Including: firmware, audio, name etc.

=====

IP Control Box VIP-UHD-CTRL Input Info

FW Version: xxx

In	Net	Sig	Ver	EDID	Aud	MCast	Name
001	On	On	A7.3.0	DF015	HDMI	On	Transmitter 001

CEC	LED	SGEn/Br/Bit
On	3	Off /9/8n1

IM	MAC
Static	00:19:FA:00:58:23

IP	GW	SM
169.254.003.001	169.254.003.001	255.255.000.000

=====

Command: VW STATUS

The VW STATUS will show all VW status feedback for Video Wall arrays in the system. Additional Video Wall arrays will have individual status feedback i.e. 'VW 2 STATUS'.

=====

IP Control Box VIP-UHD-CTRL Video Wall Info

FW Version: xxx

VW	Col	Row	CfgSel	Name
02	02	02	02	Video Wall 2

OutID
001 002 003 004

CFG	Name
01	Configuration 1

Group	FromIn	Screen
A	004	H01V01 H02V01 H01V02 H02V02

02 Configuration 2

Group	FromIn	Screen
A	002	H02V01 H02V02
B	001	H01V01 H01V02

=====

Troubleshooting the VIP-UHD-CTRL

Try using the below instructions to test the VIP-UHD-CTRL should difficulties be encountered when using a computer to control the VIP-UHD-CTRL.

1. Connect the computer directly to the VIP-UHD-CTRL Control Port with a CAT cable
2. The computer must be in the same range as the LAN connection 1 on the VIP-UHD-CTRL device (CONTROL network) as this will simulate the control from a control system. Please see instructions at the rear of this manual for 'Changing your computer IP details'.
3. Open cmd.exe program (Command prompt). Use the search tool of the computer if unsure where this is located.

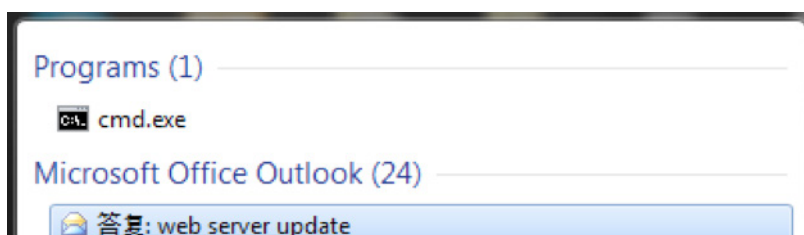

4. Enter the following command line 'Telnet 192.168.0.225'
The following window will be displayed to confirm being logged into the VIP-UHD-CTRL successfully:

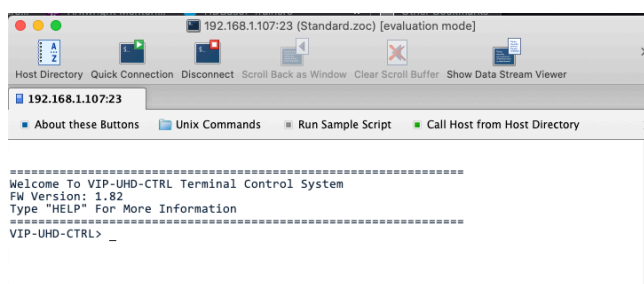

Telnet error:

If the error message: *'telnet is not recognized as an internal or external command, operable program or batch file'*, activate Telnet on your computer, or download a recognized terminal program.

Unable to see the LAN ports of the VIP-UHD-CTRL:

If unable to communicate (ping) the ports of the VIP-UHD-CTRL, connect directly to the network switch and not via a DHCP modem router to test.

Able to ping the product but not login via Telnet connection:

If unable to communicate (ping) the ports of the VIP-UHD-CTRL, connect directly to the network switch and not via a DHCP modem router to test.

Manual Configuration of VIP Products

The RTI VIP system can be configured without the need of a computer, allowing basic setup options such as addressing of products (IP configuration), EDID selection (TX), and Scaler output selection (RX).

Manual configuration does not require the product to be connected to a network switch in order to be setup, it only requires the unit to be powered either by local power supply (24-54V 1A) or by a PoE switch/power injector. This means total configuration can easily be achieved offsite without any network hardware in place.

Please note: Advanced features such as video walls cannot be setup via manual configuration, and requires the VIP-UHD-CTRL web-GUI.

Configuring the VIP-UHD-TX:

1) **Power the VIP Transmitter** - to configure the Transmitter first connect the product to a power supply (local or PoE network) and wait for the product to boot-up. The front panel LED display will rotate whilst booting and display a 2 digit number when complete. This will be '00' if the unit has default settings.

2) **Put the VIP-UHD-TX into 'Local Configuration' mode** - once the product is powered press both the 'UP' and 'DOWN' channel buttons on the front panel at the same time for 6 seconds to enter 'Local Configuration' mode. The LCD front display of the product will show '**LC**' when it is in this mode.

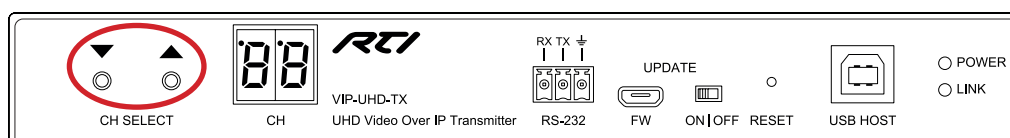

3) **Assign the Transmitter ID (IP address)** - once the product is in Local Configuration (LC) mode the display will begin to flash with a lowercase 't' to indicate the assigning of the transmitters identity. The identity will also be the IP address that is automatically assigned, so is of utmost importance that an individual ID not equal to another TX unit in the system is assigned:

- The first ID that should be assigned is ID001 = 169.254.3.1 (IP address 1)
 - The second ID that should be assigned is ID002 = 169.254.3.2 (IP address 2)
- and so on....

Once the ID number has been selected and is correct, confirm the selection by pressing both Channel 'UP' and 'DOWN' buttons at the same time to continue to setting the EDID.

4) **Set the EDID** - once the product is in EDID configuration mode the display will begin to flash with an 'E' to indicate that the assigning of an EDID value is about to commence. Use the 'UP' or 'DOWN' arrows to select the EDID setting required. A full list of EDID settings can be found on page 61.

Once the required EDID has been selected, press both Channel 'UP' and 'DOWN' buttons together to finalise the manual configuration. Two horizontal lines will appear on the display before the unit reboots.

Once the VIP-UHD Transmitter has rebooted, the new settings will be applied.

Manual Configuration of VIP Products... continued

Configuring the VIP-UHD-RX:

1) **Power the VIP-UHD Receiver** - to configure the Receiver first connect the product to a power supply (local or PoE network) and wait for the product to boot up. The front panel LED display will rotate whilst booting and display a 2 digit number when complete. This will be '00' if the unit has default settings.

2) **Put the VIP-UHD-RX into 'Local Configuration' mode** - once the product is powered press both the 'UP' and 'DOWN' channel buttons on the front panel at the same time for 6 seconds to enter 'Local Configuration' mode. The LCD front display of the product will show '**LC**' when it is in this mode.

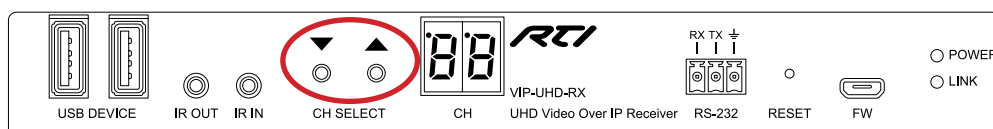

3) **Assign the Receiver ID (IP address)** - once the product is in Local Configuration (LC) mode the display will begin to flash with a lowercase 'r' to indicate the receivers identity is going to be assigned. The identity will also be the IP address that is automatically assigned, so is of utmost importance that an individual ID not equal to another RX unit in the system is assigned:

- The first Receiver ID assigned is ID001 = 169.254.6.1 (IP address 1)
 - The second Receiver ID is ID002 = 169.254.6.2 (IP address 2)
- and so on....

Once the ID number has been selected and is correct, confirm the selection by pressing both Channel 'UP' and 'DOWN' buttons at the same time to move on to setting the scaled output.

4) **Set the Video Scaler of the Receiver** - once the product ID has been configured the display will begin to flash with an 'S' to indicate that the scaler output is next to be configured. Use the 'UP' or 'DOWN' arrows to select the scaler setting required. A full list of scaler settings can be found on page 61.

Once the Scaler output that is required for the display connected to the HDMI output of the RX has been set, press both Channel 'UP' and 'DOWN' buttons at the same time to move onto setting permissions.

5) **Setting Permissions** - after the scaler output has been set, the permissions of the Receiver now need to be configured. The display in the unit will start to flash with the letters 'CH'. Use the 'UP' or 'DOWN' arrows to select the permission number required.

Permissions allow for the Receiver to be set up so that it can / cannot access Transmitters within the system. If the system has 6x TX units and the RX is set to 05, the Receiver will have access to the first 5x transmitters (ID's 001 - 005) and not any other Transmitter after. The number set will equal the last Transmitter in the system that can be accessed.

Setting the permission value to '00' ignores the permissions and will mean that the Receiver being manually configuring can therefore access ALL transmitters in the system.

Once the permission value required has been selected, press both Channel 'UP' and 'DOWN' buttons to finalise the manual configuration.

The VIP Receiver will then reboot with the new settings applied.

Manual EDID & Scaler Settings Overview

EDID	VIP-UHD TRANSMITTER EDID SETTINGS
00	Default EDID (Pass-through)
01	HDMI 1080i@60Hz, Audio 2ch PCM
02	HDMI 1080i@60Hz, Audio 5.1ch PCM/DTS/DOLBY
03	HDMI 1080i@60Hz, Audio 7.1ch PCM/DTS/DOLBY/HD
04	HDMI 1080p@60Hz, Audio 2ch PCM
05	HDMI 1080p@60Hz, Audio 5.1ch PCM/DTS/DOLBY
06	HDMI 1080p@60Hz, Audio 7.1ch PCM/DTS/DOLBY/HD
07	HDMI 1080p@60Hz / 3D, Audio 2ch PCM
08	HDMI 1080p@60Hz / 3D, Audio 5.1ch PCM/DTS/DOLBY
09	HDMI 1080p@60Hz / 3D, Audio 7.1ch PCM/DTS/DOLBY/HD
10	4K2K 4:2:0, Audio 2ch PCM
11	4K2K 4:2:0, Audio 5.1ch PCM/DTS/DOLBY
12	4K2K 4:2:0, Audio 7.1ch PCM/DTS/DOLBY/HD
13	4K2K 4:4:4, Audio 2ch PCM
14	4K2K 4:4:4, Audio 5.1ch PCM/DTS/DOLBY
15	4K2K 4:4:4, Audio 7.1ch PCM/DTS/DOLBY/HD
16	DVI 1280x1024@60Hz, Audio None
17	DVI 1920x1080@60Hz, Audio None
18	DVI 1920x1200@60Hz, Audio None

SCALER	VIP-UHD RECEIVER SCALER SETTINGS
00	Pass Through - allows native source resolution to pass-through to display * (default setting)
01	HDMI 2160p@30Hz
02	HDMI 2160p@24Hz
03	HDMI 1080p@60Hz
04	HDMI 1080p@50Hz
05	HDMI 720p@60Hz
06	HDMI 720p@50Hz
07	HDMI 1280x1024@60Hz
08	HDMI 1024x768@60Hz
09	HDMI 1360x768@60Hz
10	HDMI 1440x900@60Hz
11	HDMI 1680x1050@60Hz

Accessing the VIP-UHD Web-GUI Interface

Each RTI VIP product is shipped with a fixed (default) IP address of 169.254.100.254. Once your PC network is amended to work in the same IP range as the fixed IP of the VIP product/s, it is then possible to communicate directly with the built-in web server of each VIP-UHD Transmitter or Receiver.

Following configuration using either the: VIP-UHD-CTRL Web-GUI, by manual configuration, or the Web-GUI interface of the product, the unit will have a different IP address to that of the factory default. The IP address of a configured VIP product can be found by pressing and holding the 'UP' channel button on the product for approx. 6 seconds, the products IP address will be shown using the front panel display by displaying each of the 4 numeric parts of the IP address in order.

Please note: there is a single dot in the top left hand portion of each of the digital 7-segment numeric displays. To obtain a 3-digit number from a 2-digit numeric display, the two dots are used to determine the first number / digit of the possible 3 digits of an IP address. For example: the IP address: 169.254.3.101 would be displayed as:

. 6 9 .. 54 03 . 01

The 'Scan' feature of the VIP-UHD-CTRL web-GUI can also be used to show all connected VIP products within a system. Entering the fixed IP address (for new units), or the configured IP address of a configured unit, into a web browser on a PC, gives access to the units configuration for monitoring, resetting, firmware upgrading, or further configuration.

On entering the unit IP address into a web browser for the first time, a username and password prompt will be displayed.

Enter the username: **RTI**

Enter the password: **RTI123**

Please note: you will automatically be prompted to change the password for the unit on first log-in. Ensure that you note down the new password as this cannot be recovered. To recover the unit, the VIP-UHD unit must be factory reset which will remove any configuration of the unit.

Transmitters:

The first product to be assigned an IP address when using the VIP-UHD-CTRL web-GUI, will be given the IP address of 169.254.3.1. The next Transmitter will be assigned an IP address of 169.254.3.2 and so on....

Once the IP range of 169.254.3.x is filled (254 units), the unit will be auto-assigned of an IP address from 169.254.4.1 and so on...

Once the IP range of 169.254.4.x is filled (254 units), the unit will be auto-assigned of an IP address from 169.254.5.1 up to 169.254.5.254 - this gives a maximum configuration of 762x transmitters in any system using the VIP-UHD-CTRL web-GUI.

Receivers:

The first product to be assigned an IP address when using the VIP-UHD-CTRL web-GUI, will be given the IP address of 169.254.6.1. The next Receiver will be assigned an IP address of 169.254.6.2 and so on....

Once the IP range of 169.254.6.x is filled (254 units), the unit will be auto-assigned of an IP address from 169.254.7.1 and so on...

Once the IP range of 169.254.7.x is filled (254 units), the unit will be auto-assigned of an IP address from 169.254.8.1 up to 169.254.8.254 - this gives a maximum configuration of 762x receivers in any system using the VIP-UHD-CTRL web-GUI.

This part of the guide will explain the use of directly communicating with an individual unit. It is assumed the IP address of the unit is known.

VIP-UHD Web-GUI Interface Overview

The menu structure for the built-in web-GUI is as follows...

System (same for both TX and RX):

Version Information: an overview of the individual unit, including model number and firmware version.

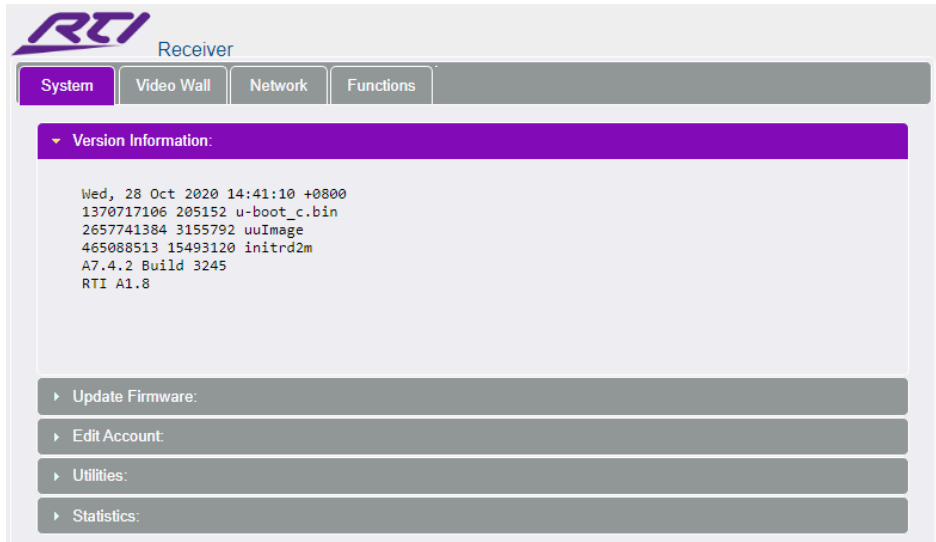

Update Firmware: it may be necessary to update the firmware of the VIP-UHD products. It is advised to check the RTI website to see if any firmware updates have been uploaded. Download these files and save them to a PC. To update the Transmitter or Receiver please follow the below instructions:

Click 'Update Firmware'

- 1) Click 'Choose file' and open the folder in which the firmware files have been saved.

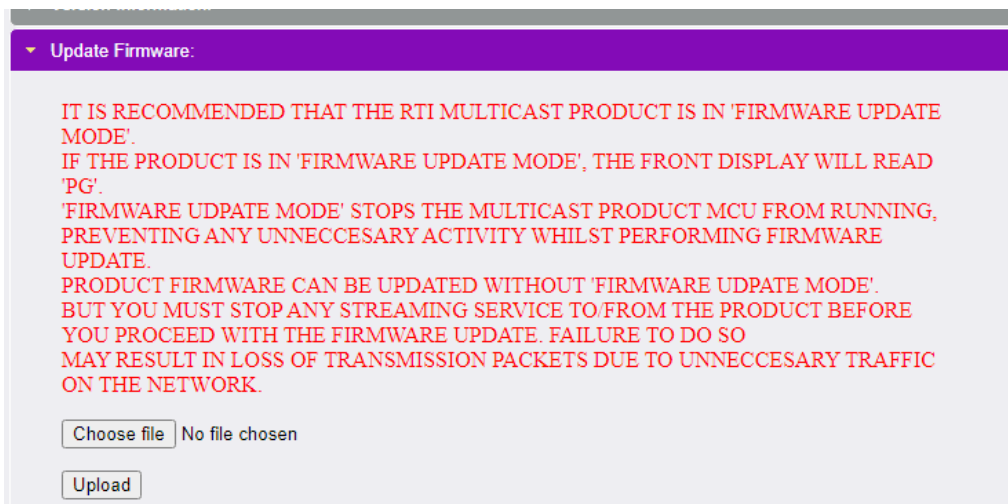

- 2) Select the require 'Transmitter.BIN' or 'Receiver.BIN' file
- 3) Click 'Upload' which will begin the firmware upgrade process
- 4) The unit will reboot once the firmware has been successfully loaded

Please note: DO NOT unplug the power or network connection to the unit during upgrade as this may result in failure to upgrade the firmware, which may lead to possible failure of the unit.

The firmware upgrade process will take several minutes. Do not connect any other VIP product to the network that has the same IP address during this time.

VIP-UHD Web-GUI Interface Overview... continued

Edit Account:

The Edit Account page allows for the username and password of the unit to be amended.

Enter details as required on screen and click 'Apply' to apply the new credentials:

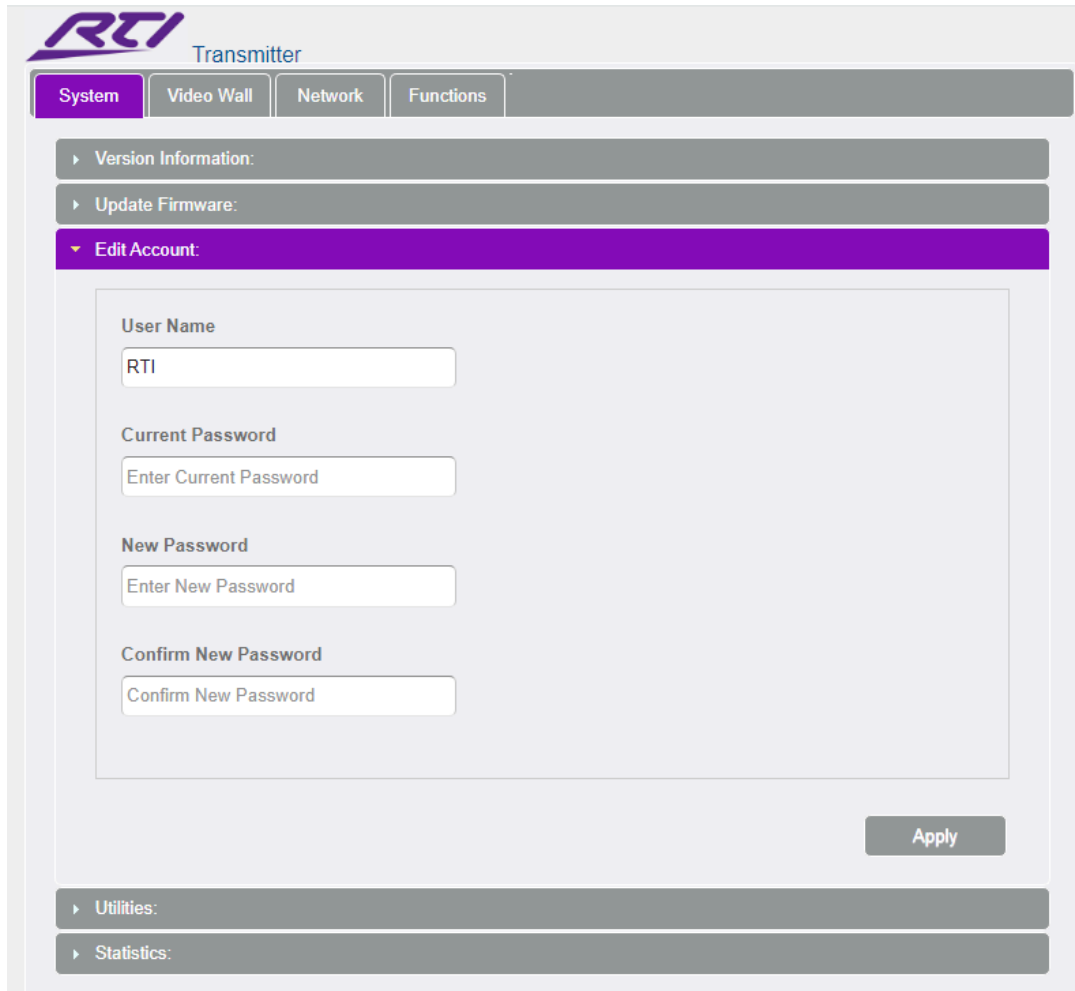

The screenshot shows the RTI Transmitter Web-GUI interface. At the top left is the RTI logo and the word "Transmitter". Below this is a navigation bar with four tabs: "System" (highlighted in purple), "Video Wall", "Network", and "Functions". The main content area is divided into several sections, each with a right-pointing arrow icon:

- Version Information:** A grey bar with a right-pointing arrow.
- Update Firmware:** A grey bar with a right-pointing arrow.
- Edit Account:** A purple bar with a downward-pointing arrow, indicating it is the active section. It contains a form with the following fields:
 - User Name:** A text input field containing "RTI".
 - Current Password:** A text input field containing "Enter Current Password".
 - New Password:** A text input field containing "Enter New Password".
 - Confirm New Password:** A text input field containing "Confirm New Password".
- Utilities:** A grey bar with a right-pointing arrow.
- Statistics:** A grey bar with a right-pointing arrow.

At the bottom right of the "Edit Account" section is a grey button labeled "Apply".

VIP-UHD Web-GUI Interface Overview... continued

Utilities (same for both TX and RX):

Factory Default - resets the Transmitter or Receiver to factory settings. The IP address will revert to: 169.254.100.254 once the unit has rebooted.

Reboot - reboots the Transmitter or Receiver unit.

Set EDID (Transmitter units only) - as per page 30, fix the EDID value for a Transmitter (source). Click 'Apply' when EDID has been selected.

Console API Command - only to be used as instructed by a member of the RTI Technical Support Team.

Output - feedback from the API command inserted above.

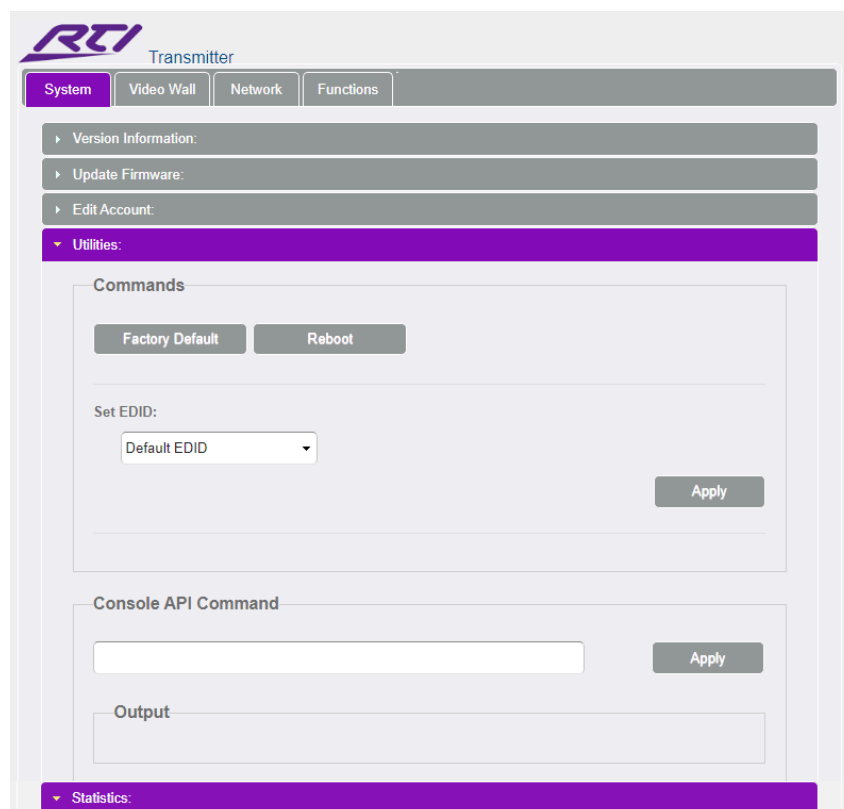

Statistics (contained within the Utilities drop-down):

Network - detailed information about the connection status of the Transmitter or Receiver (unit ID, IP address, subnet, gateway, MAC address, casting mode (Multicast / Unicast), link status and link mode). Changes to the units IP address details can only be viewed from this section, please refer to the Network tab to amend the IP structure of the unit (not recommended).

Video (Transmitter units) -

- EDID Used - the EDID structure being used between source and Transmitter.
- Local Video Output - connection status of the video signal being received from the source device.
- Video Timing Information - detailed information of the media being accepted from the source: Resolution, Pixel rate, HDMI blanking information, Color Depth, HDCP, Window sizes, Scan mode and Signal Type / Aspect Ratio.

Video (Receiver units) -

- Local Video Output - connection status of the video signal being received from the source device, HDMI mode, Signal type, Feature support, and Preferred timing.
- EDID Used - the EDID structure being used between Receiver and display device.
- Video Timing Information - Timing / Frame rate conversion, Resolution, Pixel rate, HDMI blanking information, Color Depth, HDCP, Window sizes, Scan mode and Signal Type / Aspect Ratio.

VIP-UHD Web-GUI Interface Overview... continued

Video Wall:

It is recommended that Video Wall arrays are configured and managed using the VIP-UHD-CTRL web-GUI software only. The use of this page should only be accessed on request from a member of the RTI Technical Support Team.

Network (same for both TX and RX):

Allows for the IP address details for the unit to be amended to fit with alternative IP address ranges (not recommended).

The unit can be set to Unicast (one-to-one), or Multicast (one-to-many, or many-to-many). Unicast would only be used where there are multiple point-to-point extenders on the same network where matrix functionality is not required. All RTI VIP units are shipped with Multicast set as default.

Please note: amending the IP address of VIP products may prevent other VIP equipment from being able to communicate with the unit.

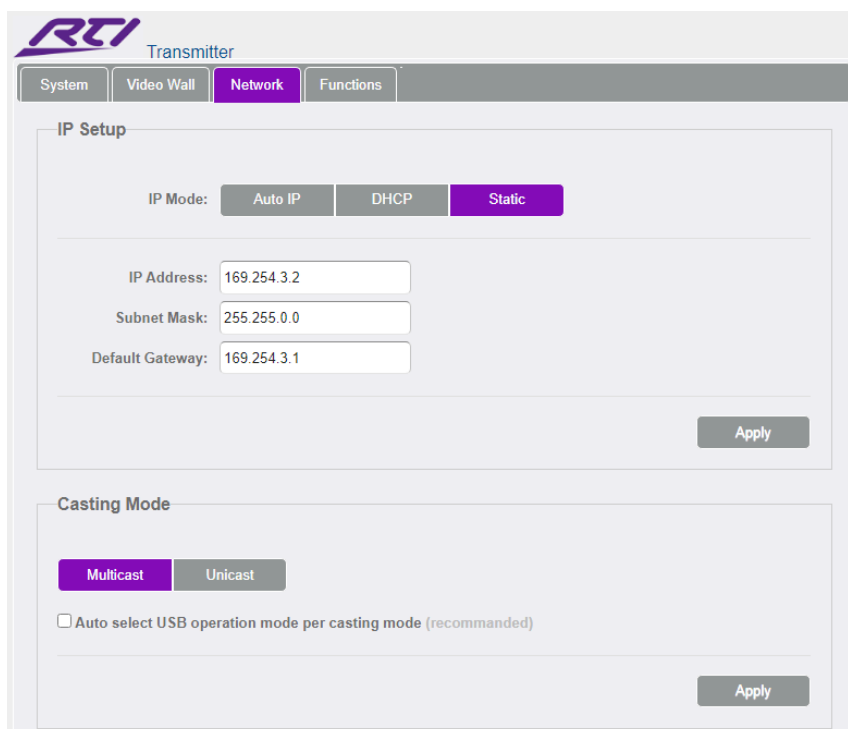

RTI Transmitter

System Video Wall **Network** Functions

IP Setup

IP Mode: Auto IP DHCP **Static**

IP Address: 169.254.3.2

Subnet Mask: 255.255.0.0

Default Gateway: 169.254.3.1

Apply

Casting Mode

Multicast Unicast

Auto select USB operation mode per casting mode (recommended)

Apply

VIP-UHD Web-GUI Interface Overview... continued

Functions (Transmitter):

Enable Video over IP: on by default. Do not un-check this box.

Enable Video Wall: on by default. Un-checking this will remove Video Wall functionality from the unit.

Maximum Bit Rate: adjust to reduce the amount of data per second that is sent by the Transmitter. Reducing this from 'Best Effort' will result in a reduction of image quality. It is recommended to keep this setting at 'Best Effort'.

Maximum Frame Rate: adjust to reduce the number of frames captured by the Transmitter from the source. Reducing this from 100% (slider to the right), will result in a reduction of the motion performance of a Multicast Receivers output when accepting a stream from the Transmitter. It is recommended to keep this setting at 100%.

Audio over IP: choose the source of the embedded audio for the stream (Auto / Line In / HDMI).

USB over IP: individual settings for the use of USB / KVM over Multicast. Choose between differing operational and compatibility modes.

Serial over IP: enable RS232 pass-through from the Transmitter, utilise this section to configure the serial settings of the system.

Functions (Receiver):

Enable Video over IP: on by default. Do not un-check this box.

Enable Video Wall: on by default. Un-checking this will remove Video Wall functionality from the unit.

Copy EDID from the Video Output: we would recommend using the VIP-UHD-CTRL web-GUI to perform the Copy EDID function within a system.

Scaler Output Mode: as per page 21, set the scaled output to match the maximum resolution of the display connected where the display cannot accept the full resolution of the source device.

Timeout for Detecting Video Lost: 10 seconds by default. Adjust this setting to hold the last frame of media received by the Receiver device before reverting to the RTI splash screen where a source device is turned off, or the connection is lost between the source and the Transmitter.

Audio over IP: choose the source of the embedded audio for the stream (Auto / Line In / HDMI)

USB over IP: individual settings for the use of USB / KVM over Multicast. Choose between differing operational and compatibility modes.

Serial over IP: enable RS232 pass-through from the Transmitter, utilise this section to configure serial settings of the system.

Please note: within any of the Transmitter or Receiver web-GUI sections, click 'Apply' to save new or amended settings.

Adjusting Computer Settings - Enabling TFTP & Telnet

1. In Windows, navigate to Start -> Control Panel -> Programs and Features
2. In the Programs and Features screen, select Turn Windows features on or off in the navigation bar on the left.

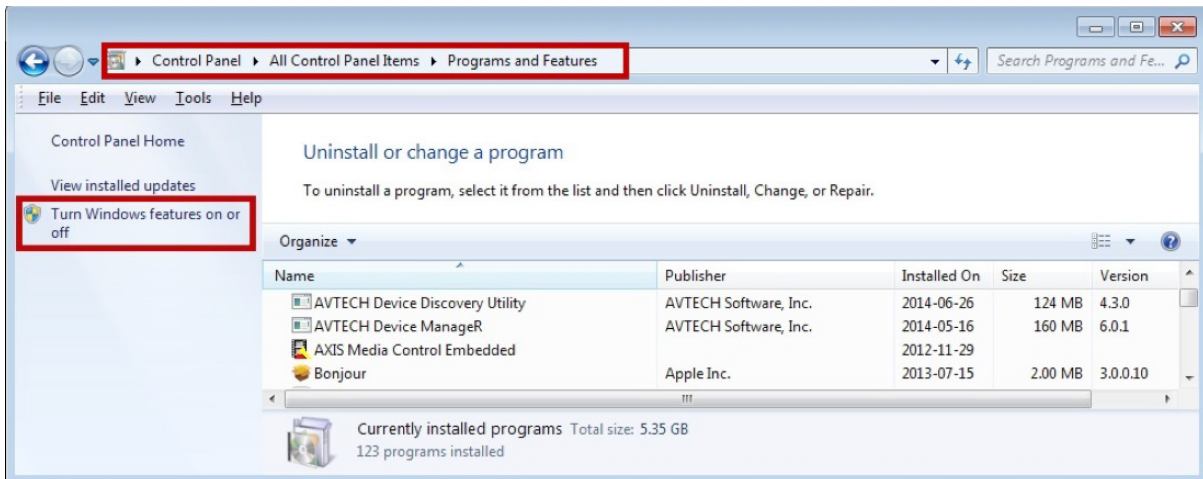

3. Once the Windows Features window populates, scroll down and make sure "TFTP client" and "Telnet Client" are both selected.

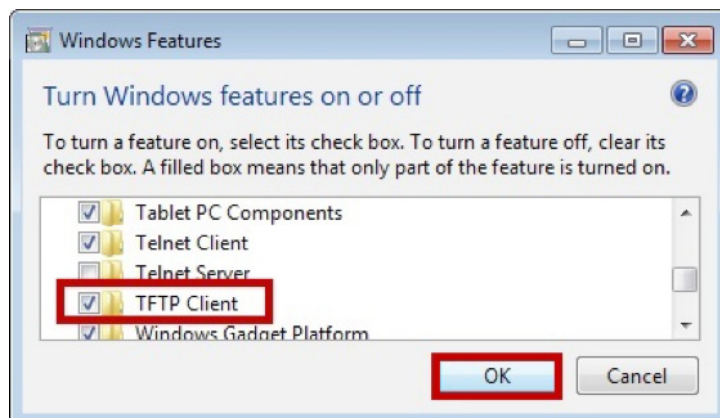

4. Once the progress bar fills and the pop up disappears, the TFTP client is enabled.

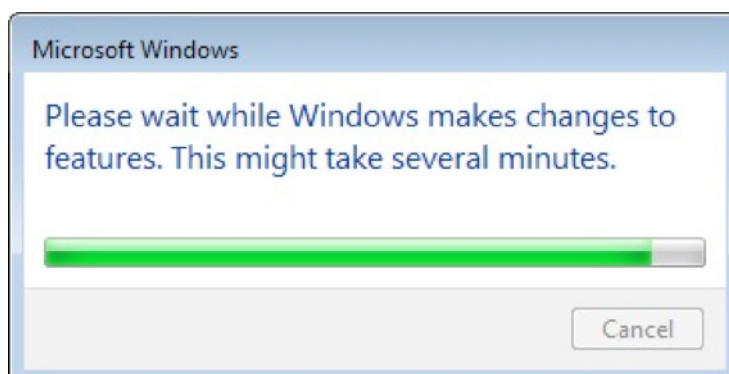

Setting a fixed IP address in Windows 7, 8 or 10

In order to communicate with the VIP-UHD-CTRL your computer must first be in the same IP range as the VIP-UHD-CTRL Control or Video LAN ports. By default the ports have the following IP address:

Control LAN port	DHCP (or on a fixed address of 192.168.0.225 if no DHCP server)
Video LAN port	169.254.1.253

The following instructions allow you to manually alter the IP address of your computer allowing you to communicate with VIP products.

1. In Windows, type 'network and sharing' into the search box

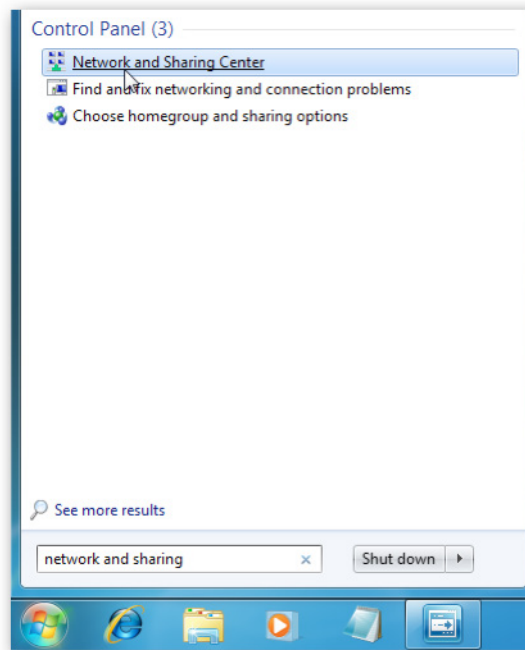

2. When the Network and Sharing screen opens, click on 'Change adapter settings'.

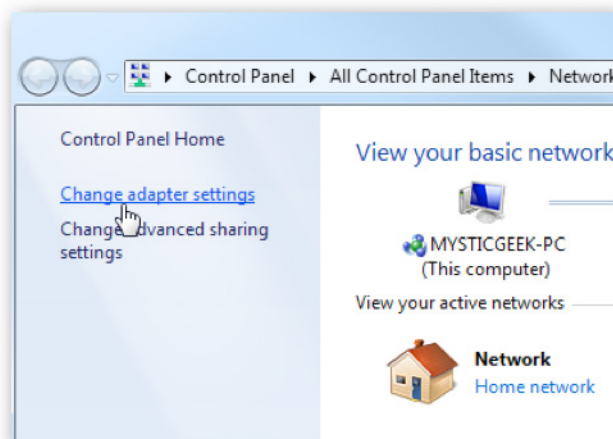

3. Right click on your Ethernet adaptor and click Properties

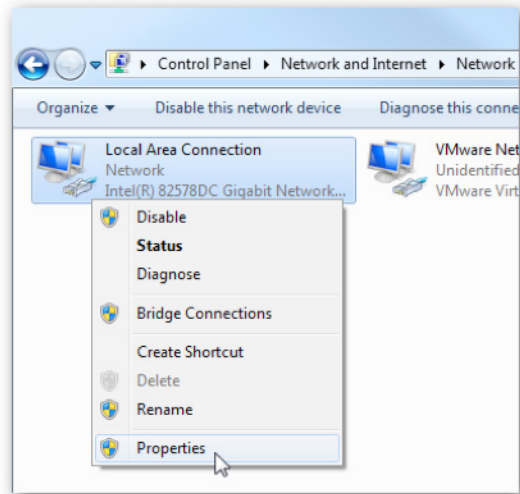

4. In the Local Area Connection Properties window highlight Internet Protocol Version 4 (TCP/IPv4) then click the Properties button.

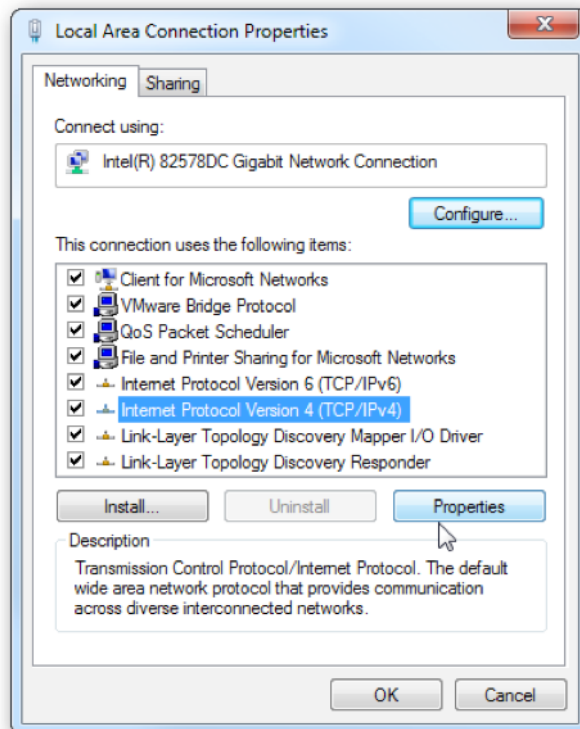

5. Select the radio button Use the following IP address and enter in the correct IP, Subnet mask, and Default gateway that corresponds with your network setup.

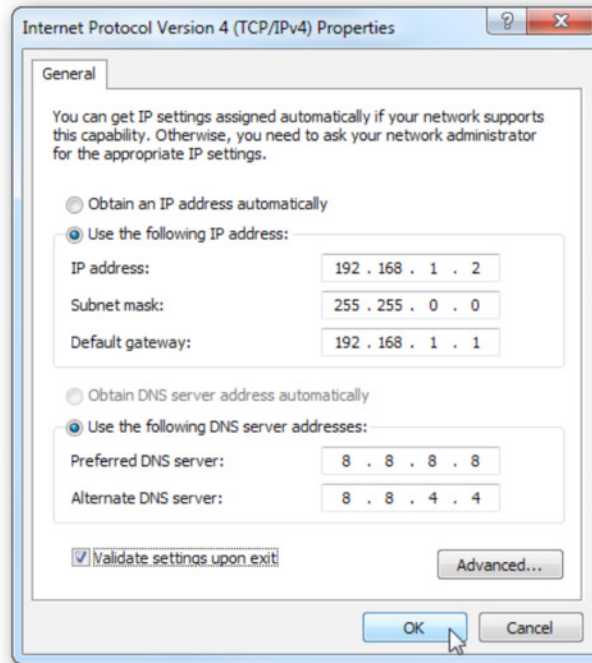

6. Press OK and close out of all network screens. Your IP address has now been fixed.

Integrator Notes...



Integrator Notes...

