



IP Cameras

MEGAPIX® IVA+™ models	5MP models	2.1MP/1080p models
DWC-MPF5Wi4TW	DWC-MF5Wi4TW	DWC-MF2Wi4T
DWC-MPF5Wi6TW	DWC-MF5Wi6TW	DWC-MF2Wi4TW
DWC-MPF5Wi8TW	DWC-MF5Wi8TW	DWC-MF2Wi28TW
DWC-MPF2Wi4TW		
DWC-MPF2Wi28TW		



Default Login Information: admin | admin

When logging into the camera for the first time, you will be prompted to set up a new password. You can set the new password using the DW® IP Finder™ software or directly from the camera's browser menu.

WHAT'S IN THE BOX

Quick Setup and Installation Guide		1 set	Bolt and Nuts 2pcs		1 set
Mounting Templates		1	Screws and Plastic Anchors - 2pcs		1 set
Waterproof Cap		1 set	Star Wrench		1
Moisture absorber and installation guide (recommended)		1 set			

NOTE: Download all your support materials and tools in one place

- Go to: <http://www.digital-watchdog.com/resources>
- Search your product by entering the part number in the 'Search by Product' search bar. Results for applicable part numbers will populate automatically based on the part number you enter.
- Click 'Search'. All supported materials, including manuals and quick start guide (QSGs) will appear in the results.



Attention: This document is intended to serve as a quick reference for the initial set-up. It is recommended that the user read the entire instruction manual for complete and proper installation and usage.

STEP 1 - PREPARING TO MOUNT THE CAMERA

- The mounting surface must withstand five times the camera weight.
- Do not let the cables get caught in improper places or the electric line cover can be damaged. This may cause a short or fire.
- CAUTION:** These servicing instructions are for use by qualified service personnel only. To reduce the risk of electric shock do not perform any servicing other than that contained in the operating instructions unless you are qualified to do so.
- CAUTION:** There is a risk of explosion if the battery is replaced incorrectly and it should be replaced only with the same battery. **ATTENTION:** Il y a risque d'explosion si la batterie est remplacée par une batterie de type incorrect. Mettre au rebut les batteries usages conformément aux instructions.
- Used batteries must be disposed of according to local regulations or the battery manufacturer's instructions. Disposing of batteries in a fire or in a hot oven, or mechanically crushing and cutting them may cause an explosion.
- Leaving the battery in very high temperature or low air pressure environments may result in an explosion or leak of flammable liquids or gases.
- This product is intended to be supplied by a UL Listed Power Supply Unit marked "Class 2" or "LPS" or "PS2" and rated 12 Vdc, 0.49A (DWC-MPF5Wi and DWC-MF5Wi series) and 0.33A (DWC-MF2Wi and DWC-MPF2Wi series) min.
- The wired LAN hub providing power over the Ethernet (PoE) in accordance with IEEE 802.3af shall be a UL Listed device with the output evaluated as a Limited Power Source as defined in UL60950-1 or PS2 as defined in UL62368-1.
- Unit is intended for installation in a Network Environment 0 as defined in IEC TR 62102. As such, associated Ethernet wiring shall be limited to inside the building.

- For the installation process, remove the dome cover from the camera module by loosening the three (3) screws on the dome. Use the wrench provided with the camera.

11. Install the moisture packet in the base of the camera's lens.

- Remove the moisture absorber from the packaging.
- Cut the card and folder along the dotted line.
- Place the moisture absorber around the camera's lens module.

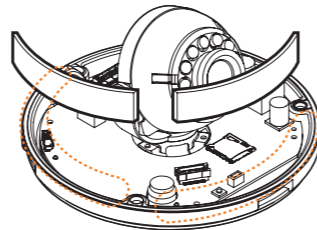

NOTE: The camera will generate enough heat to dry moisture during operation. In most cases it will not need the moisture absorber for more than the first day. In cases where the camera can experience a moisture issue, users must keep the moisture absorber in the camera. The moisture absorber has an approximately 6-month life cycle, varying depending on the environment.

WARNING: It is highly recommended that you install the moisture absorber when mounting the camera. The moisture absorber prevents moisture from being captured inside the camera's housing, which may cause image performance issues and damage the camera.

- Remove the protective film between the dome and the camera module.
- Remove the Poron Ring before placing the dome back on the camera. When attaching the dome back, align the line on the dome with the one on base of the camera.
- Using the mounting template sheet or the camera itself, mark and drill the necessary holes in the wall or ceiling.

STEP 2 - POWERING THE CAMERA

Pass the wires through and make all the necessary connections.

- NETWORK CONNECTIONS** - If you are using a PoE switch, connect the camera using an Ethernet cable for both data and power.
- NETWORK CONNECTIONS** - If you are using a non-PoE switch, connect the camera to the switch using an Ethernet cable for data transmission and use a power adapter to power the camera.

Models	Power requirements	Power consumption
DWC-MPF5Wi4TW DWC-MPF5Wi6TW DWC-MPF5Wi8TW DWC-MF5Wi4TW DWC-MF5Wi6TW DWC-MF5Wi8TW	DC 12V, PoE IEEE 802.3af Class 3. (Adapter not included)	DC12V: max 5.9W PoE: max 7.2W
DWC-MPF2Wi4TW DWC-MPF2Wi28TW DWC-MF2Wi4TW DWC-MF2Wi4T DWC-MF2Wi28TW	DC 12V, PoE IEEE 802.3af Class 2. (Adapter not included)	DC12V: max 4W PoE: max 5.5W

STEP 3 - INSTALLING THE CAMERA

- Attach the main body to the mount bracket by tightening the lock screw.
- For soft installation surfaces, use the included metal mount plate. Fix the mount plate on the mounting surface using the included screws. Then, press the bottom case onto the mount plate. The three bezels on the case will align and snap lock onto the plate.

- To use the camera's waterproof wiring:

- Install the LAN cable into **a**.
- b** will be assembled to **a** with a 1/4 turn.
- Thread **c** tightly to **b**.

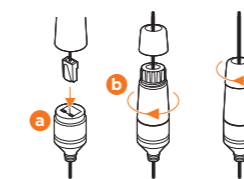

NOTE: To ensure moisture seal, make sure the o-ring is in place between **a** and **b**. In extreme environments use of an outdoor rated sealer is recommended.

NOTE: When using the waterproof cap, crimp the RJ45 connector after passing the cable through the waterproof cap.

- Once the installation is complete, adjust the camera's tilt, panning and rotation as needed. The cameras' max angles are:
Pan: 0° - 360°, Tilt: 0° - 70°, Rotation: 0° - 360°
- Assemble the dome cover over the camera body and detach the protecting film from the dome bubble.

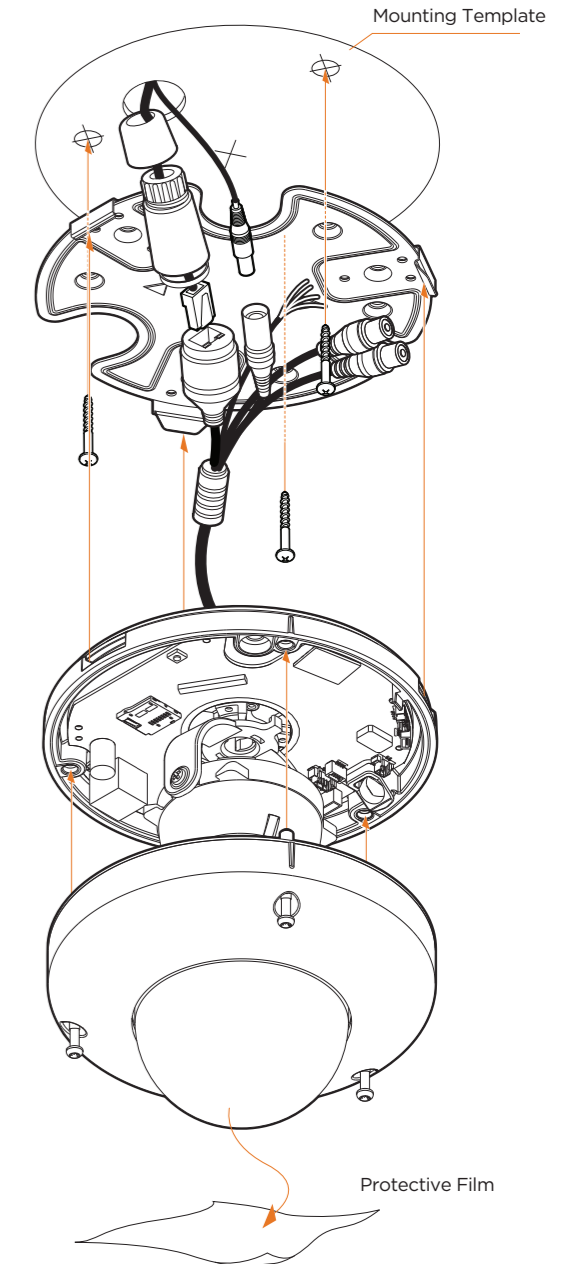

Resetting the camera: To reset the camera, use the tip of a paper clip or a pencil and press the reset button. Pressing the button for five (5) seconds will initiate a camera-wide reset of all the settings, including network settings.

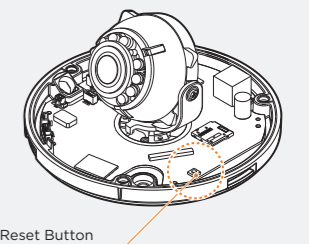

STEP 3 - INSTALLING THE CAMERA (CONT.)

Installation using Mount Bolt and Screws:

- Using the mounting template, mark and drill the holes on the mounting surface.
- Secure the two long mounting screws to the camera's base.
- Pass the wires through the mount bracket and make all necessary connections.
- Mount the camera to the mounting surface by using the 2 mounting nuts. Rotate the locking discs over the screws until the camera is held tightly from the mounting surface.

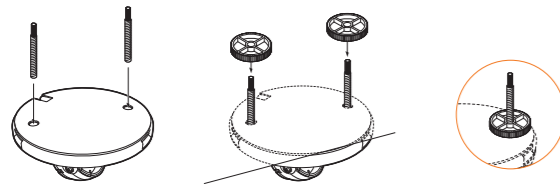

STEP 4 - CABLING (DWC-MPF5Wi and DWC-MF5Wi series)

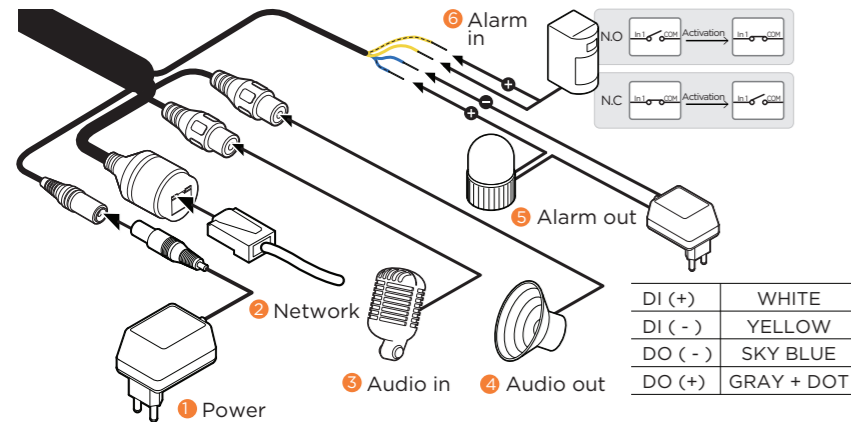

STEP 5 - MANAGING THE SD CARD

- To install the camera's SD Card, locate the SD card slot in the back of the camera module.
- Insert a class 10 SD card into the SD card slot by pressing the SD card slot.
- To remove the SD Card, press the card inward to release from the card slot.

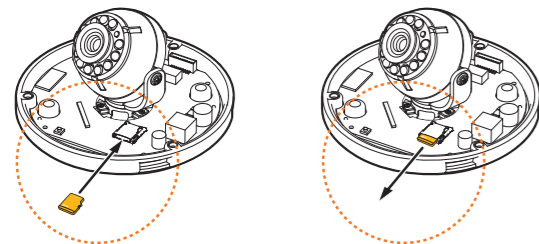

STEP 5 - DW® IP FINDER™

Use the DW IP Finder software to scan the network and detect all MEGApix® cameras, set the camera's network settings or access the camera's web client.

Thumbnail view

Select network to scan

Filter results

Scan network

Show/hide thumbnail view

Refresh thumbnail view

Bulk IP assignment

Bulk password assignment

Firmware upgrade

DHCP status

Firmware version

Camera's uptime

Open IP configuration settings

Ping camera

Port information

Gateway address

Netmask address

Camera's MAC address

Part number

Camera's IP address

Camera's name

Network Setup

- To install the DW IP Finder, go to <http://www.digital-watchdog.com>
- Enter "DW IP Finder" on the search box at the top of the page.
- Go to the "Software" tab on the DW IP Finder page to download the installation file.
- Follow the installation to install the DW IP Finder. Open the DW IP Finder and click 'Scan Devices'. It will scan the selected network for all supported devices and list the results in the table. During the scan, the DW® logo will turn gray.

- Select DHCP to allow the camera to receive its IP address automatically from the DHCP server.
- Select "Static" to manually enter the camera's IP address, (Sub) Netmask, Gateway and DNS information.
 - * The camera's IP must be set to Static if connecting to Spectrum® IPVMS
- Contact your network administrator for more information.

Default TCP/IP information: DHCP

- When connecting to the camera for the first time, a password must be set. To set up a password for your new camera:
 - Check the box next to your new camera from the IP Finder's search results. You can select multiple cameras.
 - Click "Bulk Password Assign" on the left.

- In the pop-up window, enter admin/admin in the current username and password fields. Enter a new username and password to the right.
- Press "change" to apply all changes.

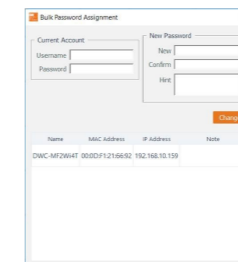

- Select a camera from the list by double-clicking on the camera's image or clicking on the 'Click' button under the IP Conf. column. The pop-up window will show the camera's current network settings, allowing admin users to adjust the settings as needed.
- To access the camera's web page, go to the IP Config page and click on the 'View Camera Website'.
- To save the changes made to the camera's setting, input the username and password of the camera and click Apply.

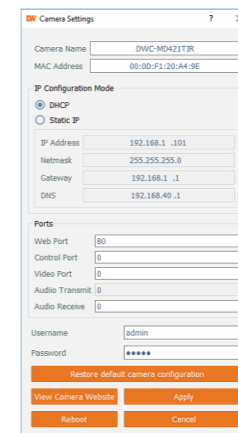

'Port forwarding' has to be set in your network's router for external access to the camera.

STEP 6 - WEB VIEWER

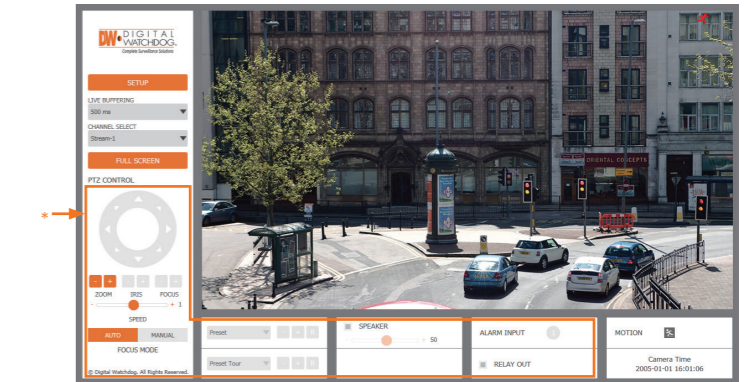

The GUI display may differ by camera models.

NOTE: Chrome browser is recommended for IVA configuration.

Once the camera's network settings have been setup properly, you can access the camera's web viewer using the DW IP Finder.

To open the camera's web viewer:

- Find the camera using the DW IP Finder.
- Double-click on the camera's view in the results table.
- Press the 'View Camera Website'. The camera's web viewer will open up in your default web browser.
- Enter the camera's username and password you setup in the DW IP Finder. If you did not setup a new username and password via the DW IP Finder, you will not be able to view video from the camera. A message will direct you to setup a new password for the camera to view video.

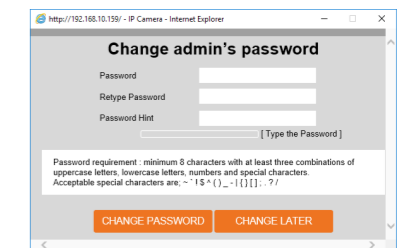

- When accessing the camera for the first time, install the VLC player for web files to view video from the camera.

NOTE: 32bit version of the VLC player must be installed. If you are using a 64bit system, uninstall the previous 64bit version and reinstall using the 32bit version.

NOTE: Some menu options may not be available based on the camera model. See the full manual for more information.