



- DWC-MBW8Wi2TW: MEGApix® 8MP ultra-wide view bullet IP camera with IVA
- DWC-MPBW8Wi2TW: MEGApix® 8MP ultra-wide view bullet IP camera with IVA+



Default Login Information: admin | admin

When logging into the camera for the first time, you must setup a new password. You can set the new password using the DW® IP Finder™ software or directly from the camera's browser menu.

WHAT'S IN THE BOX

Quick Setup and Download Guide		1	Screws and Plastic Anchors - 4pcs		1 set
Mounting Template		1	Star Wrench (T10, T20)		1
Test Video Cable		1	Moisture Absorber and Guide (Recommended)		1 set
Waterproof Cap and Gasket		1 set			

NOTE: Download all your support materials and tools in one place

- Go to: <http://www.digital-watchdog.com/resources>
- Search your product by entering the part number in the 'Search by Product' search bar. Results for applicable part numbers will populate automatically based on the part number you enter.
- Click 'Search'. All supported materials, including manuals and quick start guide (QSGs) will appear in the results.

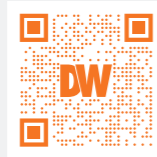

Attention: This document is intended to serve as a quick reference for initial set-up. It is recommended that the user read the entire instruction manual for complete and proper installation and usage.

STEP 1 - PREPARING TO MOUNT THE CAMERA

- The mounting surface must bear five times the weight of your camera.
- Do not let the cables get caught in improper places or the electric line cover to be damaged. This may cause a breakdown or fire.
- Install the Desi-Pack (moisture absorber) before completing the installation. The accessory Desi-Pack is provided in a sealed package and is used to prevent moisture (dew formation) caused by water entering the camera body when the cover is removed in the installation process.
 - Remove the Desi-Pack from its shipping packaging.
 - Open the camera's control panel located on the side of the camera.
 - Place the Desi-Pack in the location shown in the illustration below.
 - Close the camera control panel tightly.

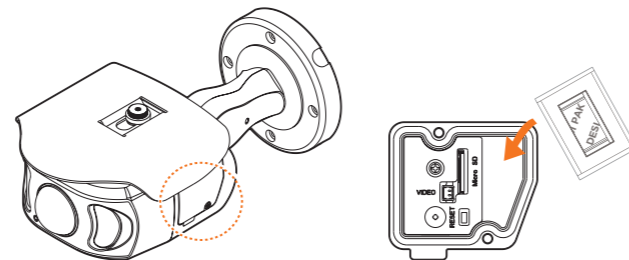

NOTE: The camera will generate enough heat to dry moisture during operation. In most cases it will not need the moisture absorber for more than the first day. In cases where the camera can experience a moisture issue, users must keep the moisture absorber in the camera. The moisture absorber has an approximately 6-month life cycle, varying depending on the environment.

WARNING: It is highly recommended that you install the moisture absorber when mounting the camera. The moisture absorber prevents moisture from being captured inside the camera's housing, which may cause image performance issues and damage the camera.

- Using the mounting template sheet or the camera itself, mark and drill the necessary holes in the wall or ceiling.

STEP 2 - POWERING THE CAMERA

Pass the wires through and make all necessary connections. See STEP 4 for more information.

- NETWORK CONNECTIONS -** Using a PoE Switch or PoE Injector, connect the camera using an Ethernet cable for both data and power.
- NETWORK CONNECTIONS -** Not using PoE Switch or PoE Injector, connect the camera to the switch using an Ethernet cable for data transmission and use a power adapter to power the camera.

Power requirements	Power consumption
DC12V, PoE (IEEE 802.3af class 3). Adapter not Included.	DC12V: max 8.9W PoE: max 12.3W

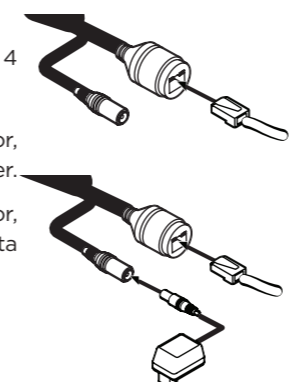

STEP 3 - INSTALLING THE CAMERA

- Once all cables are connected, secure the camera to the mounting surface using the included screws.
- To use the camera's waterproof wiring:
 - Install the LAN cable into **a**.
 - b** will be assembled to **a** with a 1/4 turn.
 - Thread **c** tightly to **b**.

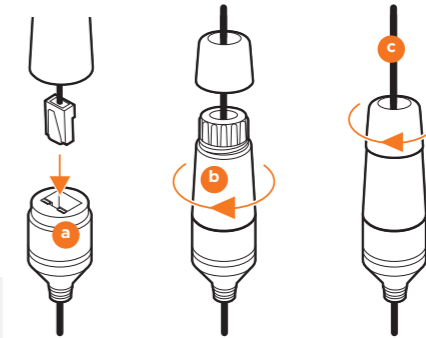

NOTE: To ensure moisture seal, make sure the o-ring is in place between **a** and **b**. In extreme environments use of an outdoor rated sealer is recommended.

NOTE: When using the waterproof cap, crimp the RJ45 connector after passing the cable through the waterproof cap.

- Loosen the pan and tilt stopper screw at the base of the camera's bracket to adjust the camera's view and position.

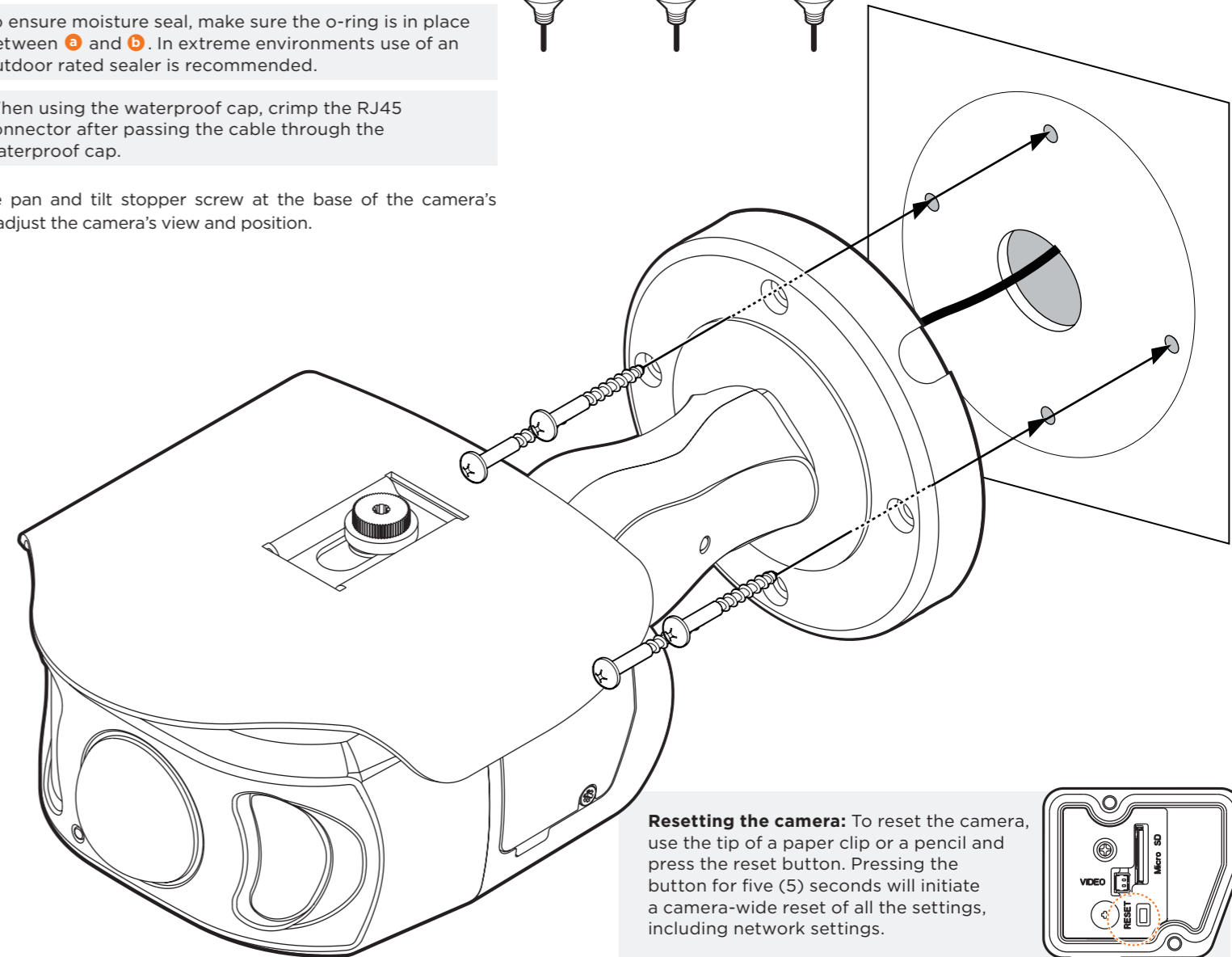

Resetting the camera: To reset the camera, use the tip of a paper clip or a pencil and press the reset button. Pressing the button for five (5) seconds will initiate a camera-wide reset of all the settings, including network settings.

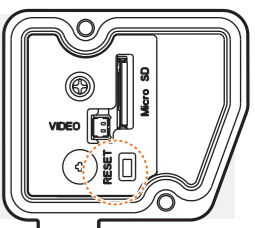

STEP 4 – CABLING

Use the diagram below to properly connect power, network, audio, alarm and sensors to the camera.

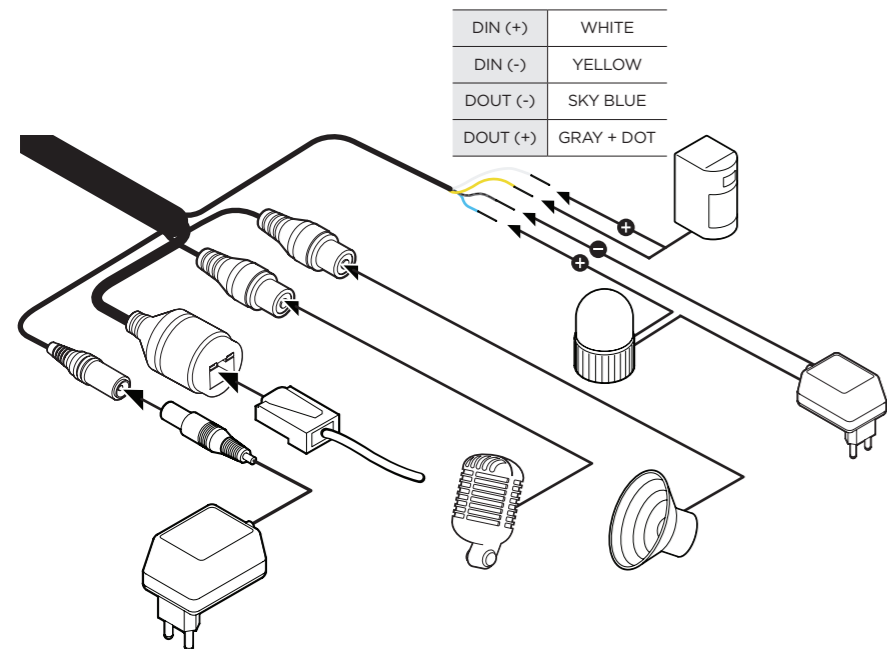

STEP 5 – MANAGING THE SD CARD

- To install the SD Card (not included), open the camera control panel on the side of the camera and locate the SD card slot.
- Insert class 10 SD/SDHC/SDXC card into the SD card slot by pressing the SD card until clicks.
- To remove the SD card, press the card inward until it clicks to release from the card slot then pull out from the slot.

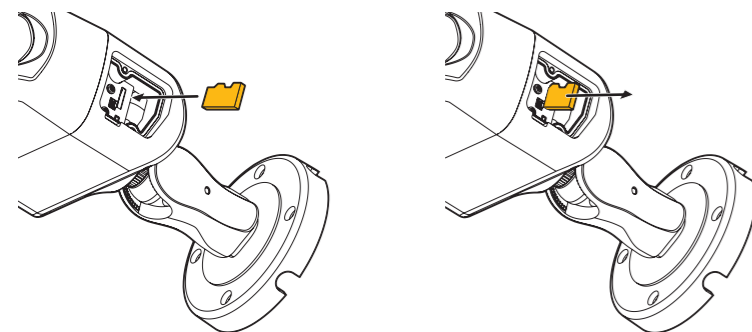

NOTE: Maximum SD Card size supported: 64GB. When inserting the SD card into the card slot, the SD card's contacts should be facing upward, as shown in the diagram.

STEP 6 – DW® IP FINDER™

Use the DW IP Finder software to scan the network and detect all MEGApix® cameras, set the camera's network settings or access the camera's web client.

Network Setup

- To install the DW® IP Finder™, go to <http://www.digital-watchdog.com>
- Enter "DW IP Finder" on the search box at the top of the page.
- Go to the "Software" tab on the DW IP Finder page to download the installation file.
- Follow the installation to install the DW IP Finder. Open the DW IP Finder and click 'Scan Devices'. It will scan the selected network for all supported devices and list the results in the table. During the scan, the DW® logo will turn gray.
- When connecting to the camera for the first time, a password must be set. To set up a password for your new camera:
 - Check the box next to your new camera from the IP Finder's search results. You can select multiple cameras.
 - Click "Bulk Password Assign" on the left.
 - In the pop-up window, enter admin/admin in the current username and password fields. Enter a new username and password to the right.
 - Press "change" to apply all changes.

- Select a camera from the list by double-clicking on the camera's image or clicking on the 'Click' button under the IP Conf. column. The pop-up window will show the camera's current network settings, allowing admin users to adjust the settings as needed.

- Select DHCP to allow the camera to receive its IP address automatically from the DHCP server.
- Select "Static" to manually enter the camera's IP address, (Sub)Netmask, Gateway and DNS information.
 - * The camera's IP must be set to 'Static' if connecting to Spectrum® IPVMS.
- Contact your network administrator for more information.

Default TCP/IP information: DHCP

- To access the camera's web page, go to the IP Config page and click on the 'View Camera Website'.
- To save the changes made to the camera's setting, input the username and password of the camera and click Apply.

NOTE: 'Port forwarding' has to be set in your network's router for external access to the camera.

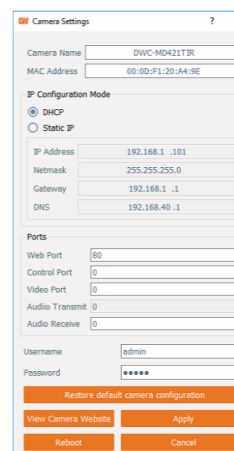
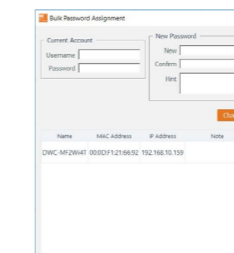

STEP 7 – WEB VIEWER

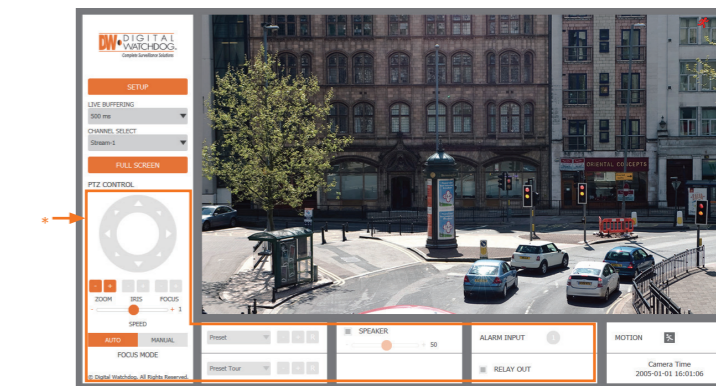

The GUI display may differ by camera models.

Once the camera's network settings have been setup properly, you can access the camera's web viewer using the DW IP Finder.

To open the camera's web viewer:

- Find the camera using the DW IP Finder.
- Double-click on the camera's view in the results table.
- Press the 'View Camera Website'. The camera's web viewer will open up in your default web browser.
- Enter the camera's username and password you setup in the DW IP Finder. If you did not setup a new username and password via the DW IP Finder, you will not be able to view the video from the camera. A message will direct you to setup a new password for the camera to view the video.

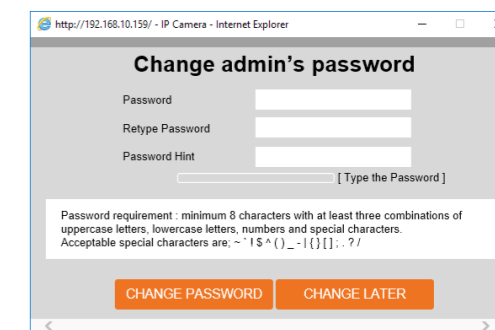

- When accessing the camera for the first time, install the VLC player for web files to view video from the camera.

NOTE: 32bit version of the VLC player must be installed. If you are using a 64bit system, uninstall the previous 64bit version and reinstall using the 32bit version.

NOTE: Some menu options may not be available based on the camera model. See the full manual for more information.