

NightWatch™ infrared, white light and hybrid illuminators

DW-ILIRIP940, DW-ILIRIP850

DW-ILHYBIP940, DW-ILHYBIP850

DW-ILWLIPM







User's Manual Ver. 12/20







Before installing and using the camera, please read this manual carefully.
Be sure to keep it handy for future reference.

Safety Information

BEFORE OPERATION

This section of the manual uses the following warning symbols to provide information regarding the use of the product to prevent you and others from being harmed and your product from being damaged. These warning symbols are described below. Ensure you understand these precautions before proceeding with the installation.

 Warning	Failure to follow the instructions provided by this warning and improper handling may cause death or serious injury		This symbol indicates prohibition. The specific prohibited action is provided in and/or around the figure.
 Caution	Failure to follow the instructions provided by this caution and improper handling may cause injury and/or property damage		This symbol requires an action or gives an instruction.

 Warning	
Never attempt to disassemble or repair the product. It may cause fire or damage to the devices.	
Hold the main unit securely when you install or service it. Exercise care not to bump the product against nearby objects or drop it inadvertently.	
 Caution	
Only use approved Power over Ethernet power supplies. Never try to power the device other than with the RJ45 PoE connection.	
Do not touch the unit connections with a wet hand or when the product is wet from rain. It may cause a short circuit and damage the unit.	
Clean and check the products periodically for safe use. If any problem is found, contact DW® or authorized partners to solve the issue before continuing to use the product.	
This product is intended to detect people and is not designed to prevent theft, disasters or accidents. The manufacturer shall not be held liable for any damage to the user's property resulting from theft, disasters or accidents.	

Contents

4 HARDWARE INTRODUCTION AND INSTALLATION

- 4 Package content
- 4 Dimensions
- 5 Specifications and certifications
- 6 Installation
- 8 Factory reset

9 WEB INTERFACE AND PROGRAMMING

- 9 Login
- 10 Events
- 12 LED settings
- 15 Device configuration
- 16 Import and export settings
- 17 Firmware update

18 ALARM SETTINGS

22 APPENDIX - TYPICAL INSTALLATIONS

23 WARRANTY

24 LIMITS AND EXCLUSIONS

INTRODUCTION

PACKAGE CONTENTS

- 1x Illuminator
- 1x waterproof cap
- 1x mount bracket
- 2x M6 screw and washer sets for bracket
- 1x Allen key
- 1x front cover opener
- 1x diffuser pack (30°, 60°, 95°)*
- 1x quick setup guide

ILLUMINATOR DIMENSIONS

DW-ILIR850IP, DW-ILIR940IP

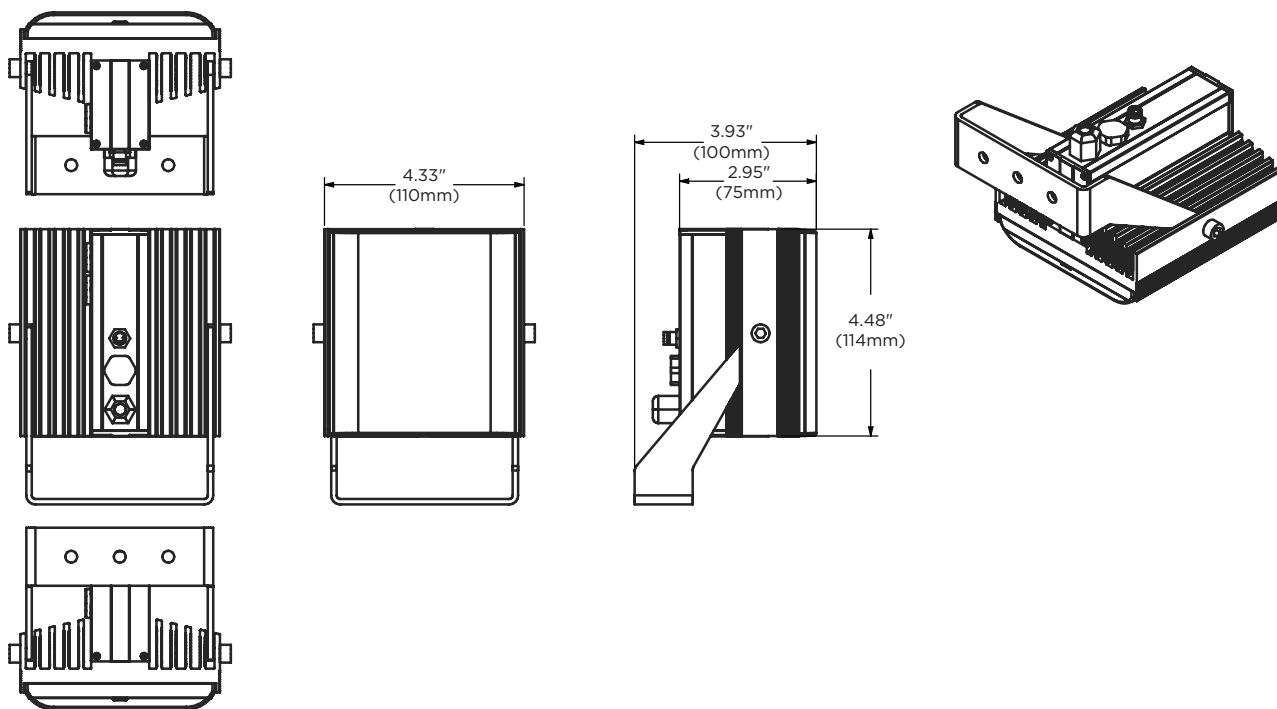

DW-ILHYB850IP, DW-ILHYB940IP

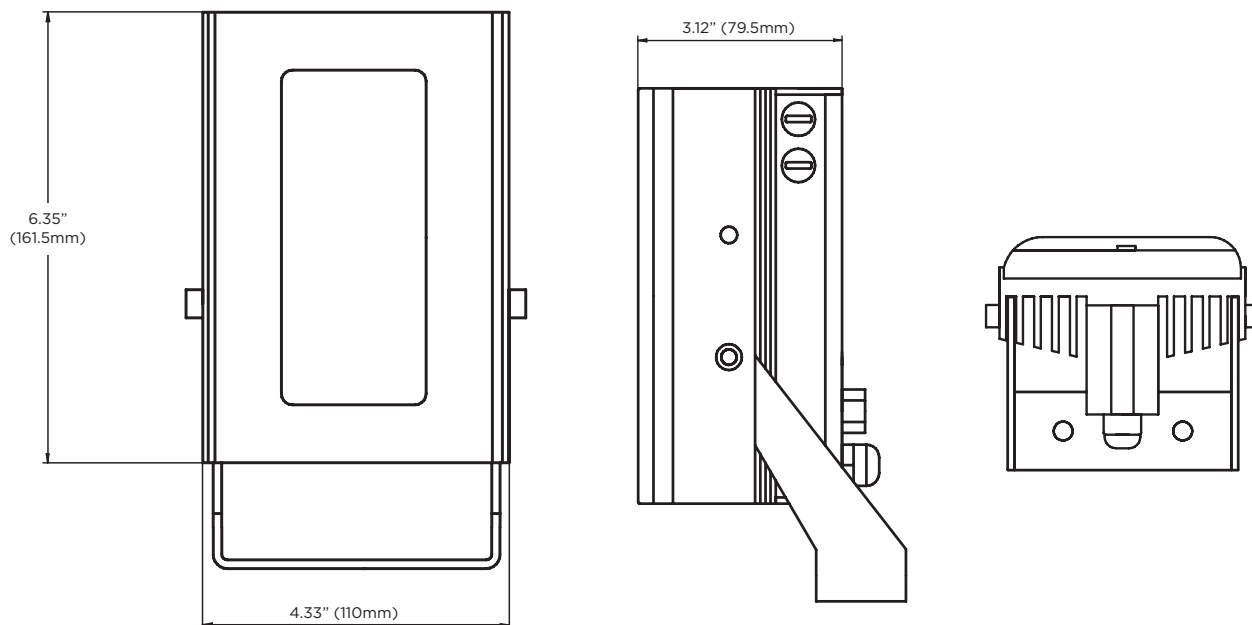

* 20° and 80° diffusers are available upon request.

SPECIFICATION



SPECIFICATIONS	DW-ILHYBIP850 / DW-ILHYBIP940	DW-ILIRIP850 / DW-ILIRIP940	DW-ILWLIPM
Construction	Robust high-quality aluminum extrusion, black anodized finish		
Photocell	Software adjustable	Adjustable 20 - 70 lux	
Illumination	Adjustable 10% - 100%		
Operating temperature	-58° to 140°F (-50° to 60°C)	-58°F to 122°F (-50°C to +50°C)	
Mount	Powder coated stainless steel wall mount		
Input	PoE+ (IEEE802.3at)		
Consumption	26W		
IP rating	IP66 environmental-rated dust-tight and water-resistant in accordance with EN60529:1992		
IK rating	IK09 impact-resistant in accordance with IEC/EN 62262	---	---
Electronics	High-efficiency surface mount high power Dual-Core™ LEDs with advanced, current limited, integral control circuitry		
Lumen output	1800 lm+	---	2400lm
Color temperature	Ultra white ≈ 6000K	---	5700K (6000K and 6500K options available to order)
Color rendering index	>70	---	Typ. 80
Recommended PSU	Any IEEE 802.3at injector (not included)		
Remote access		Web browser user interface. No software or installation needed	
Wavelength	850nm (semi-covert). Faint red glow (DW-ILHYBIP850) 940nm (covert). Minimal visible glow (DW-ILHYBIP940)	850nm (DW-ILIRIP850) 940nm (DW-ILIRIP940)	---
Coverage distance	66-614ft coverage	614' (187m) (DW-ILIRIP850) 374' (113m) (DW-ILIRIP940)	---
Warranty	2 year warranty		

A complete range of infrared, white light and hybrid illuminators for CCTV, the visible and Invisible range feature state of the art technology and installation-friendly design.

Features

- Infrared, white light and hybrid LED illuminators
- Interchangeable lens pack to deliver a variety of angles out of the box
- Direct integration with DW Spectrum® IPVMS
- Create different elliptical beam profiles
- Coverage distance up to 614' (187m). (DW-ILIRIP850, DW-ILHYBIP850)
- Coverage distance up to 374' (115m). (DW-ILIRIP940, DW-ILHYBIP940)
- Coverage distance up to 374' (115m). (DW-ILWLIPM, DW-ILHYBIP850, DW-ILHYBIP940)
- Ultra-white ≈ 6000K white light
- Configure lights to switch on when motion is detected (detector required)
- CleanView hydrophobic coating repels water, dust and grease
- Activate white light to deter intruders
- Adjustable photocell and illumination levels
- 940nm wavelength (DW-ILIRIP940, DW-ILHYBIP940)
- 850nm wavelength (DW-ILIRIP850, DW-ILHYBIP850)
- Visible spectrum wavelength (400- 750nm). (DW-ILWLIPM)
- Shock sensor
- Web interface built-in
- High-power Dual-Core™ LEDs with advanced, current limited, integral control circuitry
- NDAA/TAA compliant
- IP66 environmental-rated dust-tight and water-resistant
- IK 09-rated impact-resistant

Certifications

This product complies with the following standards:

Safety	EN 62471 Risk group 2	(Luminaires-General)
Environmental	IEC/EN 60529	(Luminaires)
	EN50130-5	(LED safety)
USA	cULus, UL 1598	IP66
	FCC, Class B	(Alarm-environmental)



This symbol on the product means that the electrical and/or electronic equipment to which it relates should be disposed of at the end of life separately from domestic household waste. For more information please contact the Local Authority or supplier of the product.

Photocell

The photocell is designed to automatically switch the lamps on at dusk and turn off at dawn. A high degree of hysteresis is incorporated to void on/off switching in marginal conditions. The unit is factory set at approximately 30 Lux On and 70 Lux Off but can be adjusted.



INSTALLATION

Note:

- Only to be installed beyond arm's reach.
- Installation should be done by skilled personnel or under the supervision of such personnel.
- The illuminator is PoE+.
- Only to be installed in restricted access areas.
- Terminal block not included. Installation may require advice from a qualified person.

Optimum results are achieved by setting it up at night and viewing the results on a monitor.

1. Attach the illuminator mount to wall or camera housing using appropriate hardware.
2. Select a diffuser with an appropriate angle based on your installation needs. To position the required diffuser sheet, using the supplied pry tool, insert it into the slot located on the bottom of the lens. Gently lift the cover upwards slowly. Repeat at the opposite end and carefully remove the cover. Remove the backing sheet from the two adhesive discs and secure the required diffuser in position. Finally, firmly clip the lens cover back into place.



3. Adjust the angle of the illuminator to match the camera's field of view.
4. Adjust the vertical alignment by loosening the side bolts (one on each side of the main body) to maximize the results.
5. Tilt the lamp downwards until the desired field of view is illuminated.
6. SLOWLY and GRADUALLY tilt the lamp upwards until the part of the required field of view is illuminated correctly on the monitor.

POWER AND CONTROL CONNECTIONS

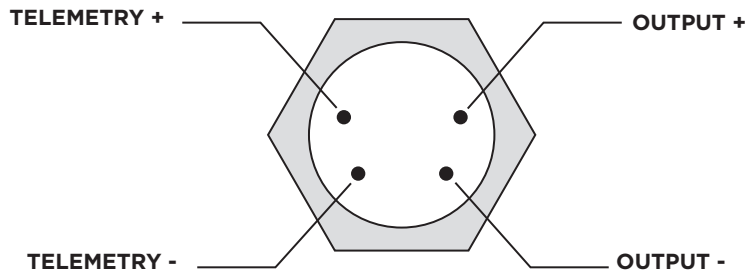

REMOTE SWITCHING

The Illuminator may be activated remotely by a volt-free contact latched across the telemetry wires (see Diagram above).

PHOTOCELL FOLLOWING CONTACT

Volt-free relay contact-normally open (day) to normally closed (night). See Diagram above.

RECOMMENDED PSU

A PoE switch or injector is recommended. The power supply should be used with devices to protect against short circuits and overload.

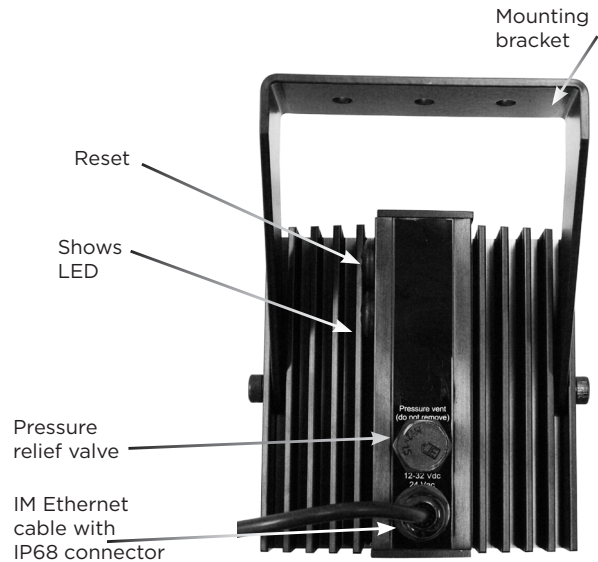

CABLING THE ILLUMINATOR

Connect to PoE+ switch or PoE+ injector for power and network connection.

The illuminators are powered by Power over the Ethernet (PoE+) via a network cable connector to a PoE IEEE802at compliant switch. The power consumption of the illuminators complies with PoE+ IEEE802at.

The illuminators are not supplied with a power cord. They are supplied with a 3.28ft (1m) long network cable. At the end of the network cable is a female RJ45 Cat5e compliant jack with an IP68 rated cover.

To use the illuminator's waterproof wiring:

- a. Install the LAN cable into **a**.
- b. **b** will be assembled to **a** with a 1/4 turn.
- c. Thread **c** tightly to **b**.

Power requirements	Power consumption
PoE+ (IEEE802.3at)	26W

NOTE: Illuminator will flash once every second when insufficient power is applied.

NOTE: To ensure moisture seal, make sure the o-ring is in place between **a** and **b**. In extreme environments use of an outdoor rated sealer is recommended.

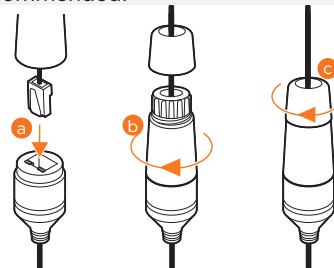

NOTE: When using the waterproof cap, crimp the RJ45 connector after passing the cable through the waterproof cap.

NOTE: Ensure that the IP68-rated cover is correctly fitted and attached to the network cable. If this is not fitted correctly, moisture can get into the connector and may cause the unit to malfunction. This would void the warranty on the product.

FACTORY DEFAULT SETTINGS

Factory reset

1. Make sure the detector is powered on.
2. Follow the diagram below to locate the reset button on the side of the illuminator.
3. Unscrew and open the cap and press the reset button according to the following options:
 - 1-2 seconds press: power cycle. The LED will flash once the button is released.
 - 3 seconds press: reset the network and user credential. The LED will flash 3 times after 3 seconds.
 - 10 seconds press: reset to factory setting (erase all). The LED will flash 3 times after 3 seconds, then will turn on again when the button is released after 10 seconds.
4. The unit's IP address and login details are now reset back to factory values.

ENSURE THAT THE IP68 RATED COVER IS CORRECTLY FITTED AND ATTACHED TO THE NETWORK CABLE. IF THIS IS NOT FITTED CORRECTLY MOISTURE CAN GET INTO THE CONNECTOR AND MAY CAUSE THE UNIT TO MALFUNCTION. THIS WOULD VOID THE WARRANTY ON THE PRODUCT.

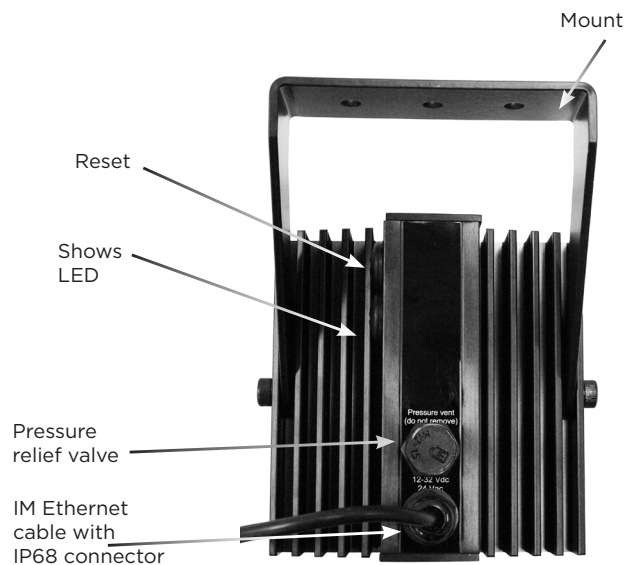

Safety Warning

- When the lamp is running, it is hot to the touch. Before touching, switch off the illuminator and allow to cool for a minimum of 10 minutes.
- The illuminator should be positioned so that prolonged staring into the illuminator at a distance closer than 1m is not expected.
- The light source of this illuminator is not replaceable, when the light source reaches its end of life the whole illuminator should be replaced.
- If the flexible power cord of the illuminator is damaged it should be exclusively replaced by an authorized service agent.
- This equipment is not suitable for use in locations where children are likely to be present.

WEB INTERFACE - LOGIN

FACTORY DEFAULT SETTINGS

When using the system for the first time, or if a factory reset has been made, the following settings are used.

Default IP address: 192.168.1.10

LOGIN

1. Open a web browser.
2. In the address field, enter the illuminator's IP address. The login page will be shown.
3. Enter your username and password. When connecting to the illuminator for the first time, set a new password.

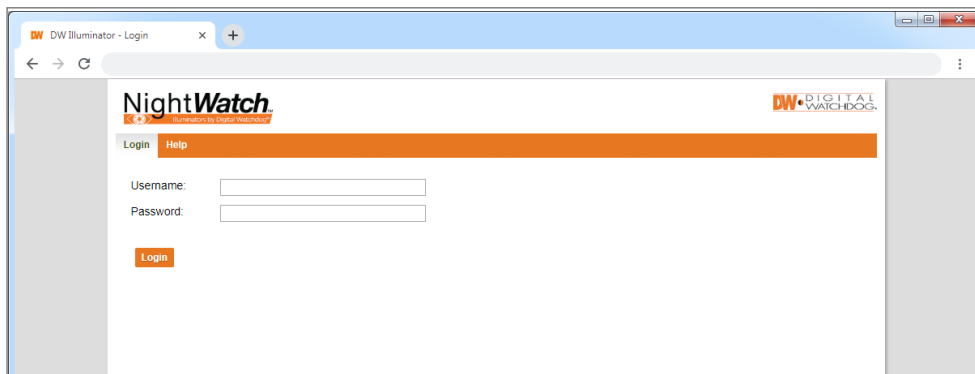

Should the user require help with logging into the illuminator, the help tab includes useful information on resetting the password and resetting the unit. The help menu is also available after login.

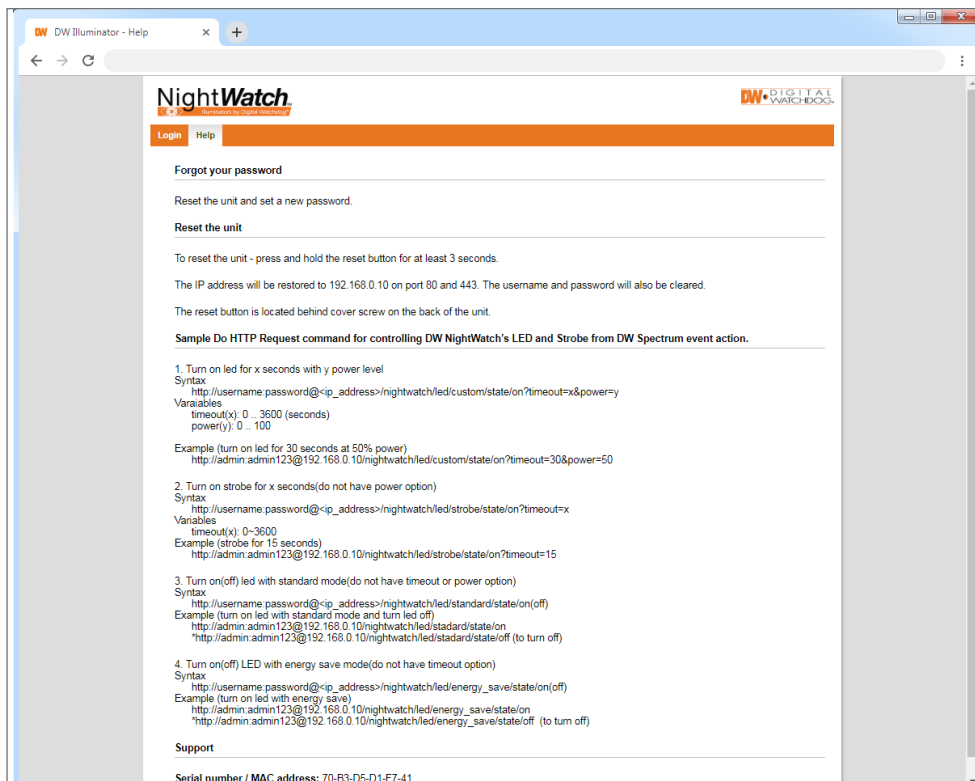

NOTE: Functions and settings may differ based on the model.

PROGRAMMING - EVENTS

EVENTS

Events are enabled by default.

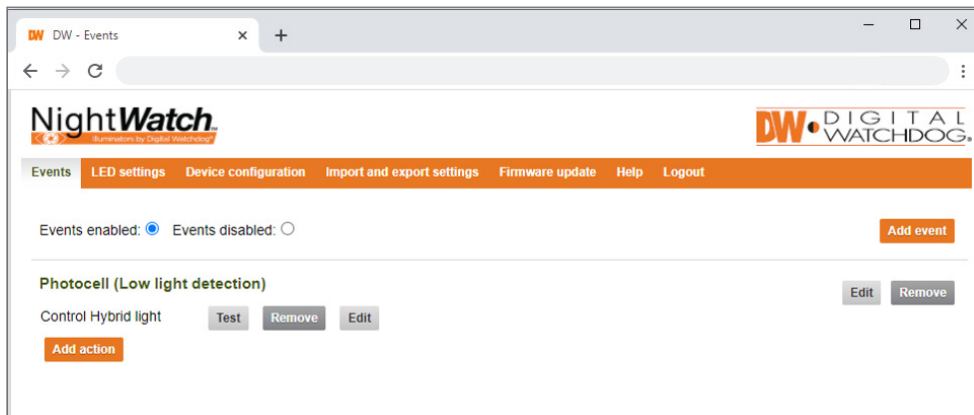

The Photocell (Low light detection) event shown above is pre-programmed into the illuminator. It can be removed or modified as needed by clicking the remove or edit buttons on the right-hand side of the screen.

Photocell (Low light detection) event is activated when the light levels are low. When low light is detected, the illuminator will turn on based on its photocell sensor readings. When light levels are high, the illuminator will turn off.

PROGRAMMING - EVENTS

To edit the Photocell (Low light detection) event, click the edit button on the right-hand side of the screen. The following pop-up screen will appear. You can adjust the following settings:

Edit event

Name:

Input:

Delay (s):

Timeout (s):

Lux level (lux):

- Delay** (Default 2 seconds) The time (in seconds) for which light level conditions must be met for the illuminator to turn on or off.
- Time-out** (Default 5 seconds) The time (in seconds) before the illuminator turns on or off once light conditions are no longer met.
- Lux level** (Default 15 lux) The light level when the camera turns on or off.

To edit the Photocell (Low light detection) action, click the edit button to the right of the action. The following pop-up screen will appear. You can change the action taken by the illuminator when the event settings are met and adjust the start and stop actions.

Control Hybrid light

Action type:

Start action:

Stop action:

- Output 1
- Control Hybrid light ✓
-
- DW Spectrum VMS
- DW NightWatch IP Illuminator
- DW NightWatch IP Hybrid Illuminator
- Connect to URL
-
- GJD Visualiser Event
- GJD Visualiser Heartbeat
- GJD IPA
-

PROGRAMMING - LED SETTINGS

LED SETTINGS - DW-ILIRIP940, DW-ILIRIP850, DW-ILWLIPM

To set the illuminator's LED power settings, go to the 'LED settings' tab.

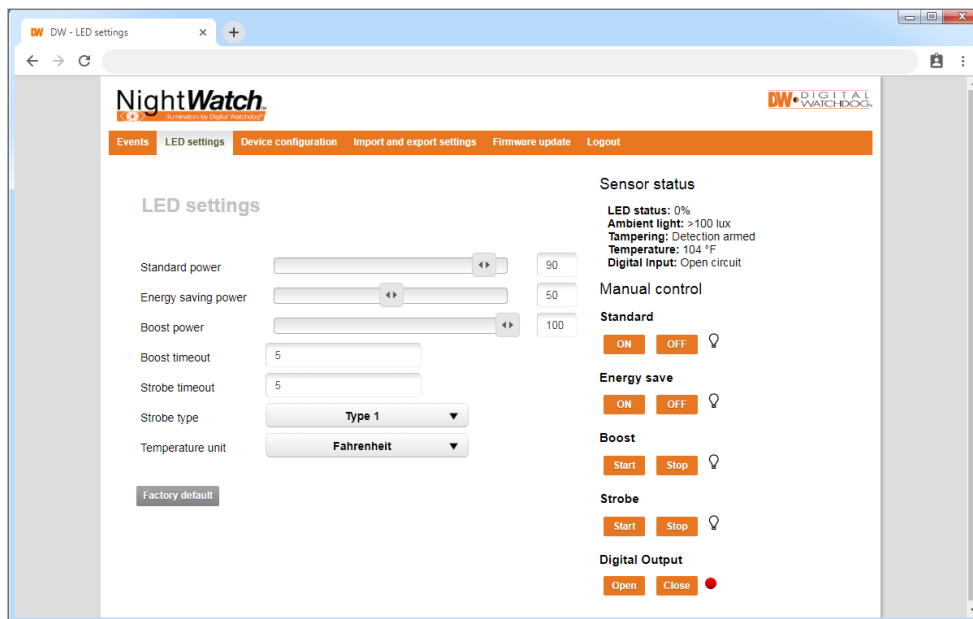

The user can reset the LED settings by clicking the factory default button on the bottom of the page.

Manual control standard:

Turn on or off the illuminator at the set power value on the slider bar. For example 80% light output.



Manual control energy save:

Turn on or off the illuminator at the set energy-saving power value on the slider bar. For example 50% light output.

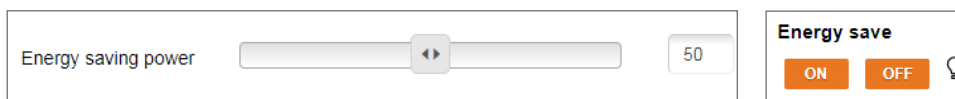

PROGRAMMING - LED SETTINGS

LED SETTINGS - DW-ILHYBIP947, DW-ILHYBIP850

To set the illuminator's LED power settings, go to the 'LED settings' tab.

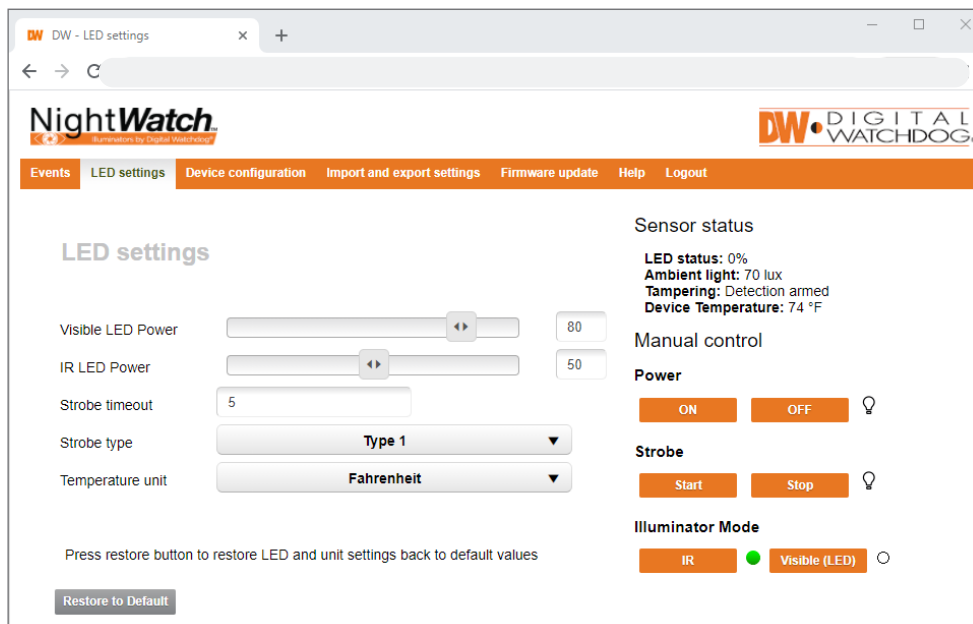

Users can reset the LED settings by clicking the factory default button on the bottom of the page.

Manual standard control:

Set the power value on the slider bars (in percentage). The illuminator will turn on or off at the set value. For example 80% light output.



Manual strobe control:

Start or stop the flashing of the LEDs after a set duration (in seconds).

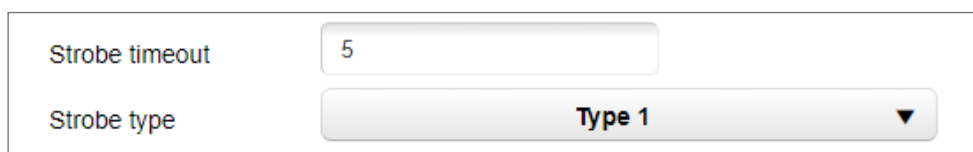

PROGRAMMING - LED SETTINGS

Manual boost control (DW-ILIRIP940, DW-ILIRIP850, DW-ILWLIPM):

Start or stop the illuminator at the set boost power value on the slider bar. For example 100% light output for 5 seconds:

Start or stop the flashing of the LEDs at the set boost power value on the slider bar. For example 100% light output for 5 seconds:



Manual control digital output:

The manual control digital output function allows you to manually open or close the illuminator's relay outputs. A green circle indicates the relay output is closed. A red circle indicates the relay output is open. By default, the illuminator's output is set to open.

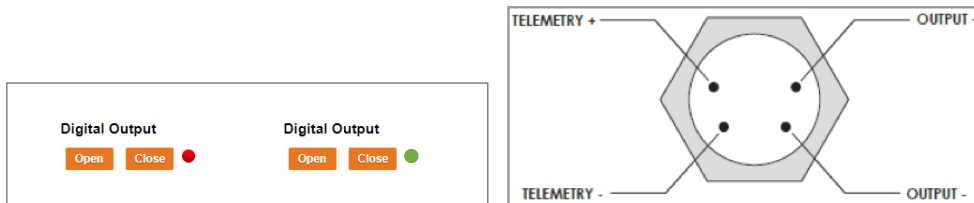

PROGRAMMING - DEVICE CONFIGURATION

DEVICE CONFIGURATION

Edit the device's network, Control4, and password, or reset the device to factory settings.

1. The illuminator supports static IP only. Enter the IP address, subnet mask and default gateway as needed. Contact your network administrator for more information.
2. Enter the HTTP (default 80) server port and host-name.
3. If the illuminator is integrated with Control4, use the Control4 section as needed.

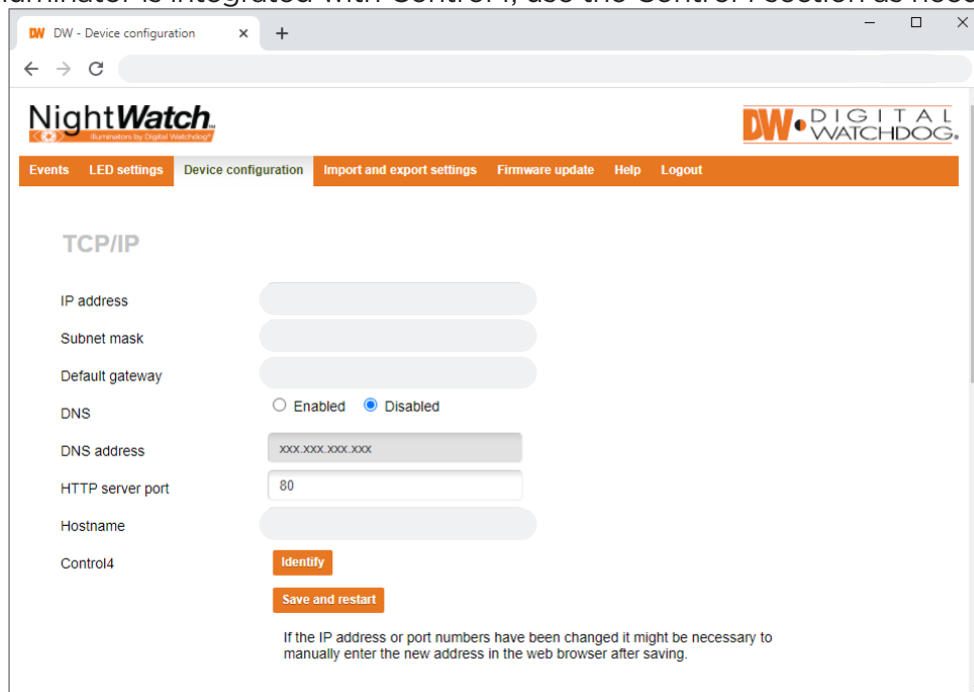

The screenshot shows a web browser window titled "DW - Device configuration". The page header includes the "NightWatch" logo and "DW DIGITAL WATCHDOG". A navigation menu contains "Events", "LED settings", "Device configuration", "Import and export settings", "Firmware update", "Help", and "Logout". The main content area is titled "TCP/IP" and contains the following fields and controls:

- IP address: Text input field
- Subnet mask: Text input field
- Default gateway: Text input field
- DNS: Radio buttons for "Enabled" and "Disabled" (with "Disabled" selected)
- DNS address: Text input field with placeholder "xxx.xxx.xxx.xxx"
- HTTP server port: Text input field with value "80"
- Hostname: Text input field
- Control4: "Identify" button
- "Save and restart" button

Below the fields, a note states: "If the IP address or port numbers have been changed it might be necessary to manually enter the new address in the web browser after saving."

If the network settings have changed, reload the page with the new IP address.

4. To change the admin's password, enter the new password twice and click 'save'.

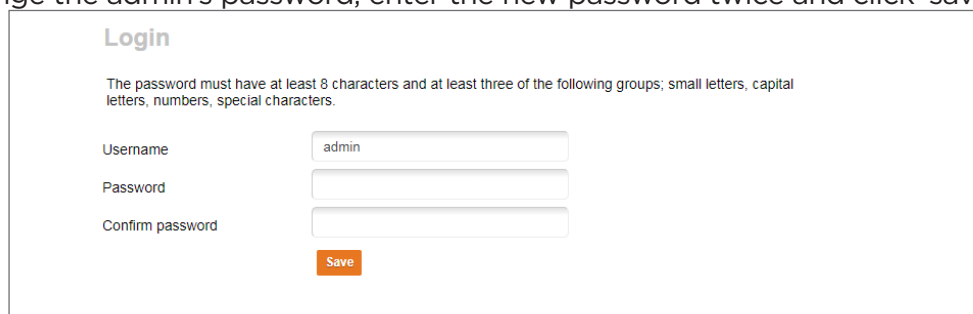

The screenshot shows the "Login" page. It includes a password requirement note: "The password must have at least 8 characters and at least three of the following groups; small letters, capital letters, numbers, special characters." Below this are three input fields: "Username" (with "admin" entered), "Password", and "Confirm password". A "Save" button is located at the bottom.

5. To reset your device to its factory setting, choose one of the following options
 - All: Reset all settings to factory default.
 - Exclude network settings and user credentials: Reset the events and device settings.

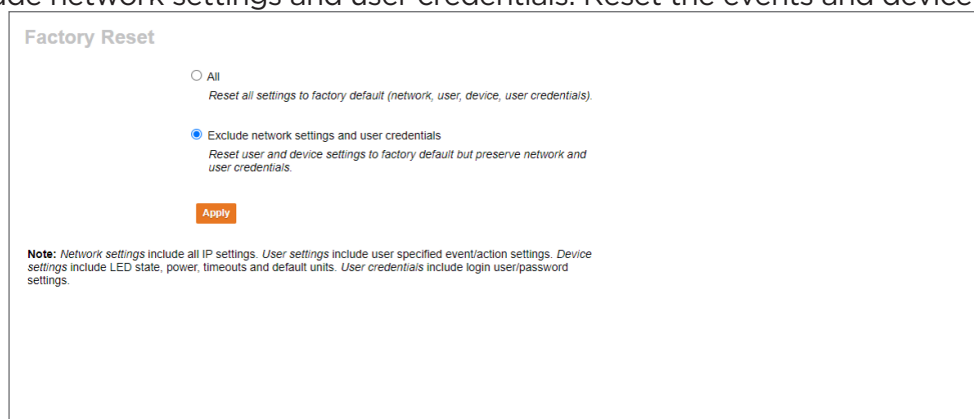

The screenshot shows the "Factory Reset" page. It features two radio button options:

- All
Reset all settings to factory default (network, user, device, user credentials).
- Exclude network settings and user credentials
Reset user and device settings to factory default but preserve network and user credentials.

An "Apply" button is positioned below the options. A note at the bottom reads: "Note: Network settings include all IP settings. User settings include user specified event/action settings. Device settings include LED state, power, timeouts and default units. User credentials include login user/password settings."

PROGRAMMING - IMPORT AND EXPORT SETTINGS

IMPORT AND EXPORT SETTINGS

You can download the illuminator's settings and use them to setup other illuminators. The illuminator's settings will be exported as a CFG file.

1. Open the 'import and export settings' tab.
2. Export all current settings by pressing the 'download settings' button. Select the file location on your hard drive as needed. The file name is unique for each detector and includes the detector's MAC-address.

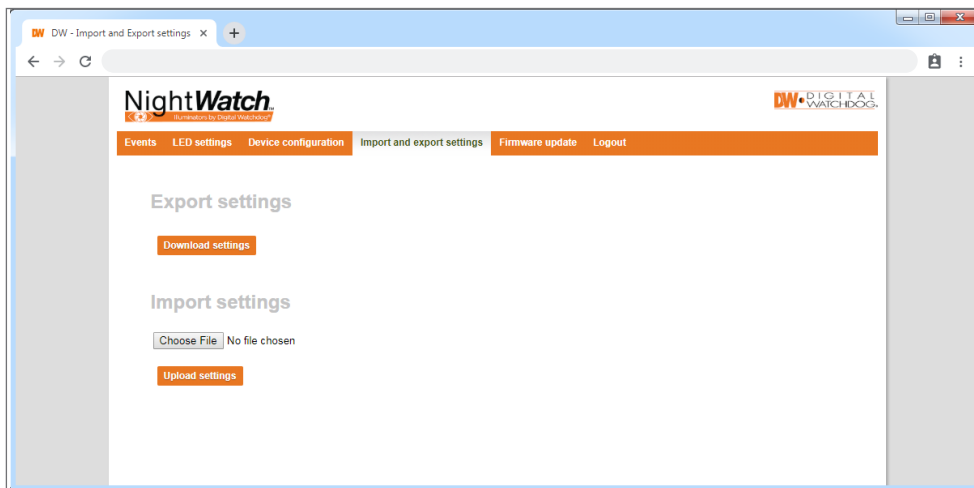

Use the import settings section to import the alarm and I/O settings from another detector as needed. Select the file from your hard drive and press the 'upload settings' button.

PROGRAMMING - FIRMWARE UPDATE

Firmware Update

The NightWatch™ illuminator's firmware should be updated when new versions are available. To update the illuminator's firmware:

1. Open the 'firmware update' tab. The current firmware version is displayed.
2. Press 'select firmware file'. Locate the firmware file on your drive and click open.
3. Click 'upload firmware'.

When the firmware update is complete, the illuminator's web-based user interface will return to the login page.

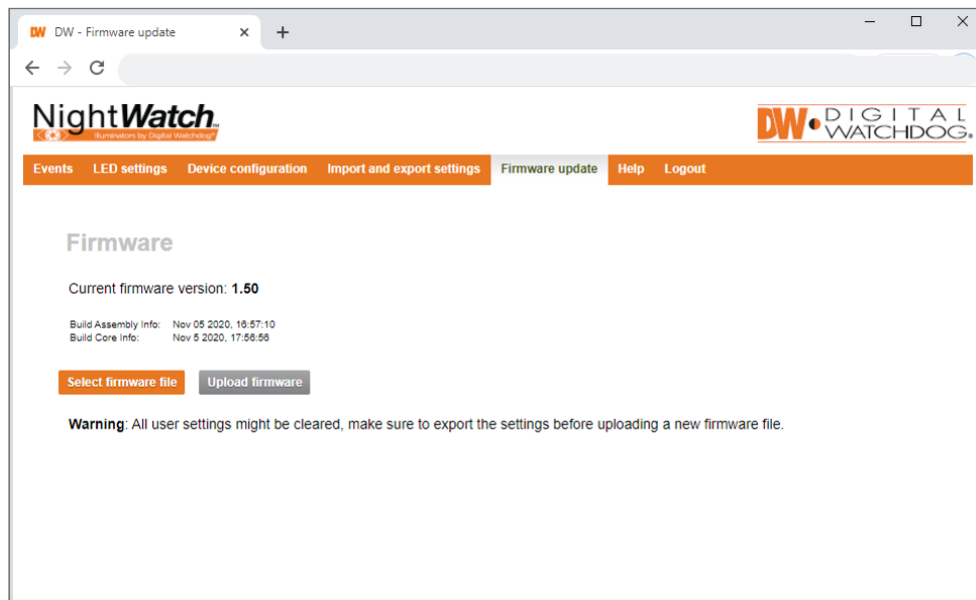

ALARM SETTINGS

EVENT - EXAMPLE 1 - INPUT FROM DETECTOR

If an external detector is connected to the telemetry input of the illuminator, users can set up an event to be triggered from that input signal. Users must add an event in the 'Event settings' tab.

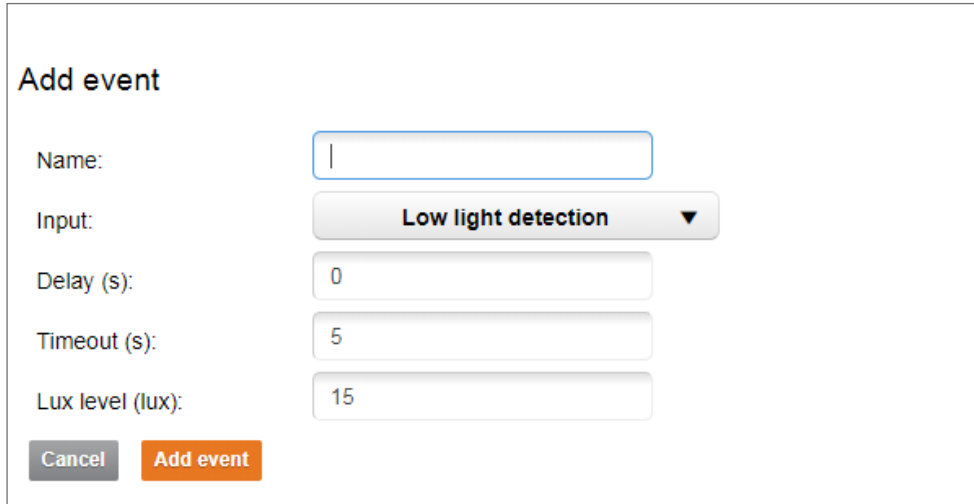

The 'Add event' form contains the following fields and controls:

- Name:** A text input field.
- Input:** A dropdown menu currently showing 'Low light detection'.
- Delay (s):** A text input field with the value '0'.
- Timeout (s):** A text input field with the value '5'.
- Lux level (lux):** A text input field with the value '15'.
- Buttons:** 'Cancel' (grey) and 'Add event' (orange).

The example below shows an event configuration for an event input from a motion detector, the input signal is defined as a 'digital input'. The condition is 'closed circuit', which means when the telemetry pins are closed together, the event will be triggered. The delay is set to 0 seconds and the time out is 15 seconds. This means the illuminator will be turned on immediately when the digital input signal is received and will remain on for 15 seconds.

Once the event is saved, it will appear as shown below:

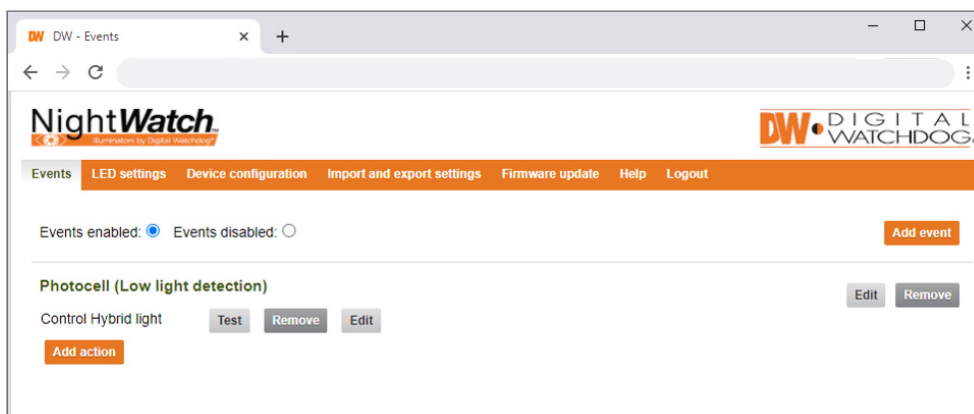

ALARM SETTINGS

Once the event has been added, users must add an action, indicating what the illuminator should do once the event occurs.

To do so, click on 'add action' under the new event. The add action pop-up screen will appear.

Select 'control light' for the action type. The start and stop actions should be as shown below and click 'add action' to save.

Add action

Action type: **Control light** ▼

Start action: **Standard on** ▼

Stop action: **Standard off** ▼

Cancel **Add action**

Once the new action is added, the new action will appear under the event in the event settings page:

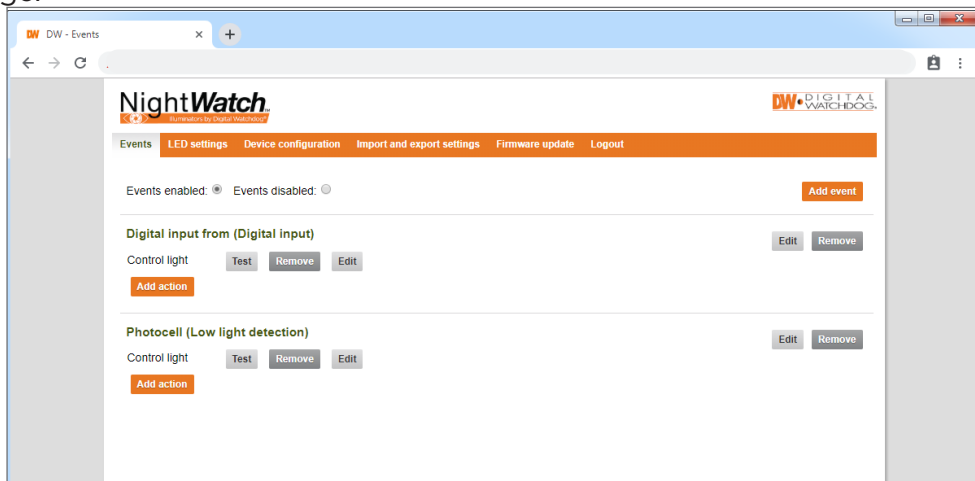

ALARM SETTINGS

EVENT - EXAMPLE 2 - OUTPUT FROM A SITEWATCH™ MOTION DETECTOR

To connect a NightWatch illuminator to a SiteWatch motion detector via an Ethernet connection, you must first add an event and action in the SiteWatch motion detector's web-based user interface. The image below shows an example of an event set up page on the detector's settings, connecting the detector to a NightWatch illuminator:

The screenshot shows the 'Add event' configuration page. It includes the following fields and options:

- Name:** Text input field containing 'NightWatch'.
- Input:** Dropdown menu showing 'PIR detection'.
- Delay (s):** Text input field containing '0'.
- Timeout (s):** Text input field containing '5'.
- Event activation:** Dropdown menu showing 'Always'.
- Light limit (lux):** Text input field containing '5'.

At the bottom of the form are two buttons: 'Cancel' (grey) and 'Add event' (orange).

Once the event has been added, it will appear under the Events tab on the SiteWatch detector:

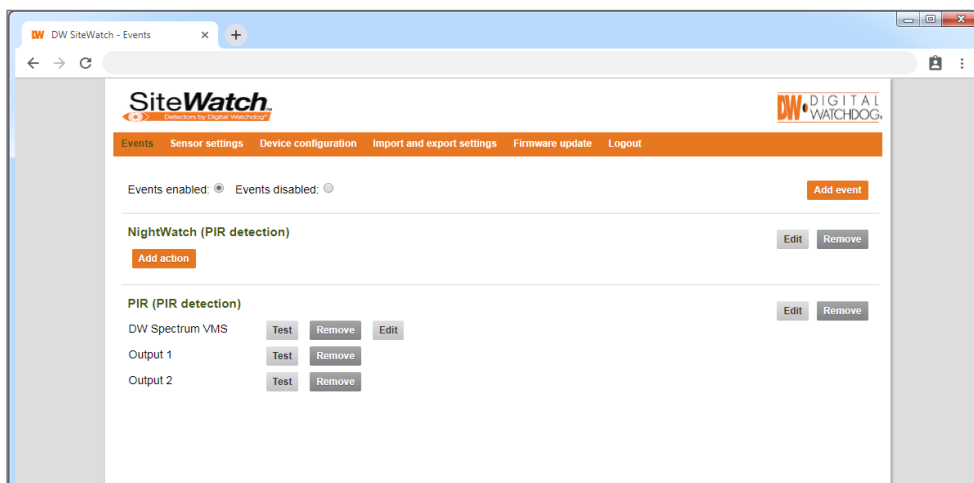

ALARM SETTINGS

Once the event has been created, press 'add action' under the event to see the screen below:

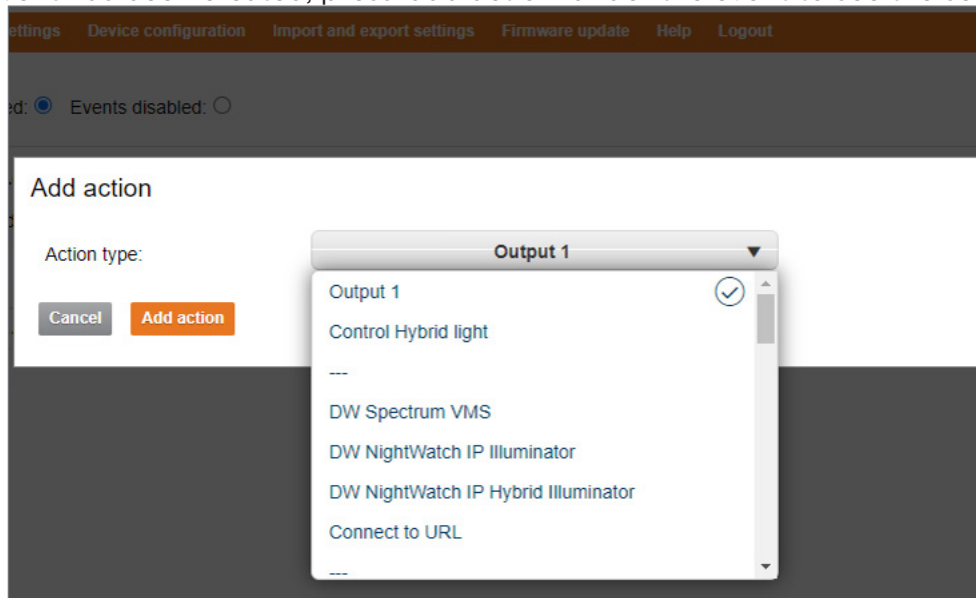

Select 'DW NightWatch IP Illuminator' or 'DW NightWatch IP Hybrid Illuminator' for the action type, and enter the illuminator's IP address, username and password in the corresponding fields. Select the station and stop actions and press "Add Action" to save.

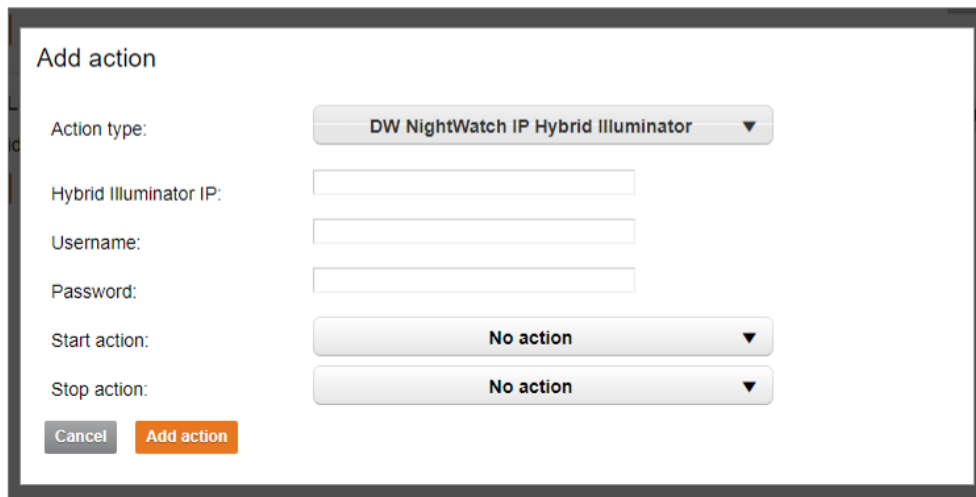

See the SiteWatch™ motion detector's user manual for more information.

APPENDIX - TYPICAL INSTALLATIONS

TYPICAL INSTALLATIONS

The example below illustrates a typical set up for the NightWatch™ illuminators:

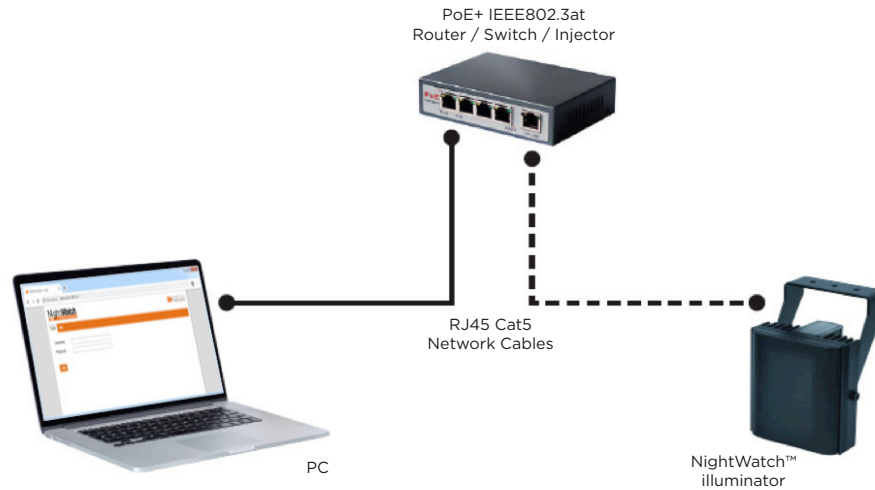

The example below illustrates a typical set up for the NightWatch™ illuminators, SiteWatch™ motion detectors and an IP camera:

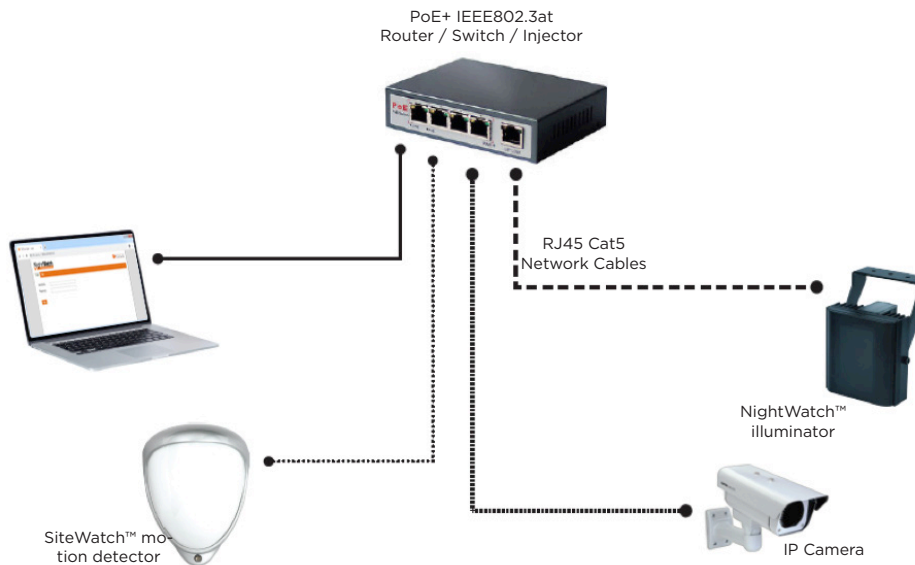

TROUBLESHOOTING

If you are experiencing difficulty connecting to your NightWatch™ illuminator through your browser, try typing in the first two parts of your own IP address XXX.XXX followed by .0.10:

Product IP number: 192.168.1.10

WARRANTY INFORMATION

Digital Watchdog (referred to as “the Warrantor”) warrants the Camera against defects in materials or workmanship as follows:

Labor: For the initial five (5) years from the date of the original purchase if the camera is determined to be defective, the Warrantor will repair or replace the unit with a new or refurbished product at its option, at no charge.

Parts: Also, the Warrantor will supply replacement parts for the initial two (2) years.

To obtain warranty or out of warranty service, please contact a technical support representative at 1+ (866) 446-3595, Monday through Friday from 9:00 AM to 8:00 PM EST.

A purchase receipt or other proof of the date of the original purchase is required before warranty service is rendered. This warranty only covers failures due to defects in materials and workmanship which arise during normal use. This warranty does not cover damages that occurs in shipment or failures which are caused by products not supplied by the Warrantor or failures which result from accident, misuse, abuse, neglect, mishandling, misapplication, alteration, modification, faulty installation, setup adjustments, improper antenna, inadequate signal pickup, maladjustments of consumer controls, improper operation, power line surge, improper voltage supply, lightning damage, rental use of the product or service by anyone other than an authorized repair facility or damage that is attributable to acts of God.

LIMITS AND EXCLUSIONS

There are no express warranties except as listed above. The Warrantor will not be liable for incidental or consequential damages (including without limitation, damage to recording media) resulting from the use of these products, or arising out of any breach of the warranty. All express and implied warranties, including the warranties of merchantability and fitness for a particular purpose, are limited to the applicable warranty period set forth above.

Some states do not allow the exclusion or limitation of incidental or consequential damages or limitations on how long an implied warranty lasts, so the above exclusions or limitations may not apply to you. This warranty gives you specific legal rights, and you may also have other rights from vary from state to state.

If the problem is not handled to your satisfaction, then write to the following address:

Digital Watchdog, Inc.
ATTN: RMA Department
16220 Bloomfield Ave
Cerritos, CA 90703

Service calls which do not involve defective materials or workmanship as determined by the Warrantor, in its sole discretion, are not covered. Cost of such service calls are the responsibility of the purchaser.