

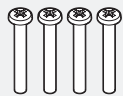

Converter plate for electronic gang box

DWC-GPLT	DWC-GPLT-W
-----------------	-------------------



WHAT'S IN THE BOX

Option A Installation Screws		4	Camera Mounting Screws		4
Option B Installation Screws		2			

NOTE: Download all your support materials and tools in one place.

1. Go to: <http://www.digital-watchdog.com/resources>
2. Search your product by entering the part number in the **'Search by Product'** search bar. Results for applicable part numbers will populate automatically based on the part number you enter.
3. Click **'Search'**. All supported materials, including manuals and quick start guide (QSGs) will appear in the results.



PRODUCT OVERVIEW

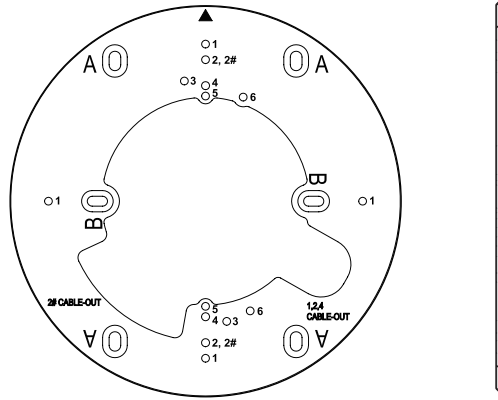

INSTALLATION

- 1 Connect the converter plate to the electric gang box.
 - ✘ Use the 4 screws (A) included with the converter plate when using a 2-gang handy electrical box.
 - ✘ Use the 2 screws (B) included with the converter plate when using a switch box or a 1-gang handy electrical box.
- 2 Pass wires through and make the connections.
 - ✘ Use the CABLE-OUT spaces in the converter plate.
- 3 Follow the table below to connect the camera to the appropriate holes.
- 4 Mount the camera to the upper side of the converter plate to complete the installation.

A. 2-gang handy electrical box

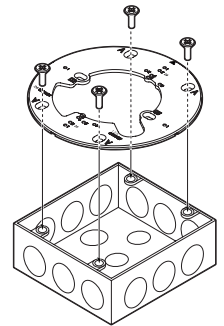

B. 1-gang handy electrical box and Switch Boxes

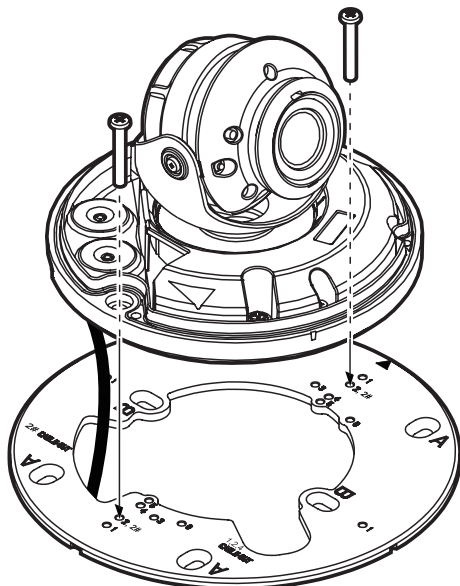
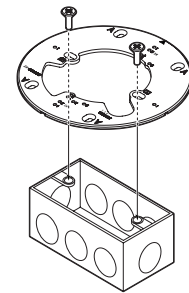

Mounting holes	Compatible cameras
Mounting holes labeled 1	V4, MV4, V6 vandal dome cameras
Mounting holes labeled 2, 2#	MF, MV8, MVD8, PVF, MVC8 low-profile vandal dome cameras
Mounting holes labeled 4	VA, MVA, MV7, D4 vandal dome and ball cameras
Mounting holes labeled 5	D3, MD7 indoor dome cameras
Mounting holes labeled 6	MD4 indoor dome cameras