

YVC-200

Unified Communications Speakerphone

User Guide

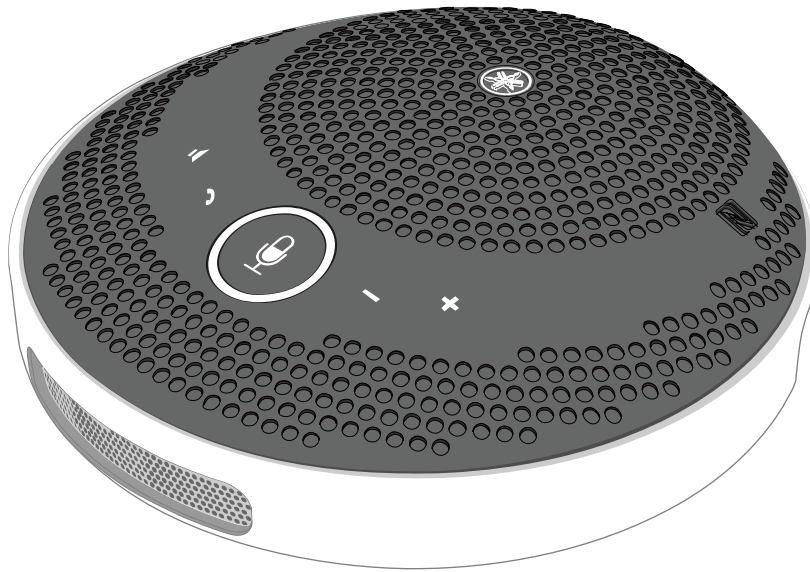

Table of contents

1. Introduction	1
1.1. About this manual.	1
1.2. Features	1
1.3. Included accessories	1
2. Components and Functions	2
2.1. Top	2
2.2. Side.	3
2.3. Bottom	4
3. Preparation	5
3.1. Charging.	5
3.2. Installing.	5
3.3. Connecting a headset/headphones	6
3.4. Connecting a Smartphone via Bluetooth	7
3.5. Connecting a Computer via USB.	9
4. Using the Product	16
4.1. Turning the Power On and Off.	16
4.2. Adjusting the Speaker Volume	16
4.3. Muting/Unmuting the Microphone	16
4.4. Muting/Unmuting the Speaker	17
4.5. Answering an Incoming Phone Call/Ending a Phone Call on a Smartphone.	17
5. Other Functions	18
5.1. Checking the Battery Level	18
5.2. Restoring Factory Default Settings.	18
5.3. Resetting	18
5.4. Updating the Firmware.	18
6. Troubleshooting.	19
6.1. Before Contacting Support	19
6.2. Problems with Bluetooth Connections.	19
6.3. Problems with Phone Call Audio Quality	19
6.4. Other Problems.	20

1. Introduction





Thank you for purchasing the Yamaha YVC-200.

This product is a speaker phone for a few people that is optimal for use by 1 to 3 people.

Read the attached safety precautions before using this product and use the product correctly and safely.

1.1. About this manual

- This manual provides information for using this product such as how to connect and how to operate.
- The symbols used in this manual and their meanings are as follows.

Symbol	Meaning
 WARNING	This content indicates "risk of serious injury or death."
 CAUTION	This content indicates "risk of injury."
 Notice	Indicates points that you must observe in order to prevent product failure, damage or malfunction and data loss.
 Important	Content that you need to know in order to operate and use the product correctly.
 Note	Information related to operation and usage. Read this for reference.

- The company names and product names in this manual are the trademarks or registered trademarks of their respective companies.
- No part of this manual may be reproduced or used in any form without the permission of Yamaha.
- The illustrations and screens in this manual are for instructional purposes only.
- The contents of this manual apply to the latest specifications as of the publishing date. To obtain the latest manual, access the Yamaha website then download the manual file.

1.2. Features

- Audio signal processing that automatically delivers the best audio quality
 - “Adaptive echo canceler” that delivers smooth two-way conversation
 - “Noise reduction” that eliminates noise emitted from sources such as projectors
 - “Auto gain control” that adjusts the volume of people near and people far from the microphone
- Microphone that captures sound omnidirectionally from all 360° and speaker that is able to output sound at a maximum of 88 dB
- Connects to computers running Windows/macOS and smartphones running iOS/Android
- “Plug and Play” connectivity using USB, Bluetooth, and NFC
- Built-in rechargeable battery capable of a maximum of 10 hours of continuous use

1.3. Included accessories

- USB cable × 1
- Safety Brochure × 1
- Quick Start Guide × 1
- Carrying case × 1

2. Components and Functions

2.1. Top

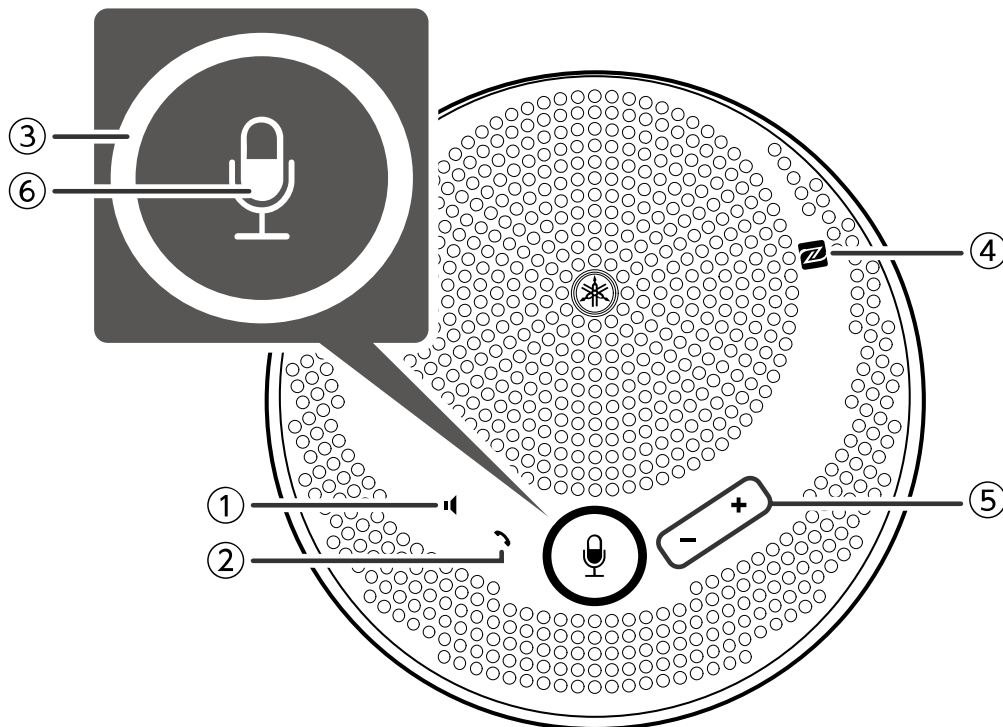

① **Speaker mute button ()**

Temporarily stops (mutes) speaker output. To cancel the mute function, press it again.

② **Call button ()**

Allows the user to receive and end calls when connected to a smartphone via Bluetooth.

③ **Microphone mute button ()**

Temporarily stops (mutes) the microphone function. To cancel the mute function, press it again.

④ **N-Mark ()**



Holding an NFC-compatible smartphone over this spot allows the user to pair it with/connect it to, or disconnect it from the product via Bluetooth.





⑤ **Volume +/- button ()**

Adjusts the speaker volume.

⑥ **Microphone indicator ()**

Displays the microphone mute and speaker mute setting states, etc.

Display	State
 Microphone light on (green)/Ring light on (green)	Normal
 Microphone flashing slowly (red)/Ring light on (red)	Microphone mute

Display	State
 Microphone light on (green)/Ring light off	Speaker mute
 Microphone flashing slowly (red)/Ring light off	Microphone and speaker mute
 Flashing rapidly (green)	Incoming call to smartphone (normal)
 Flashing rapidly (red)	Incoming call to smartphone (microphone mute)

2.2. Side

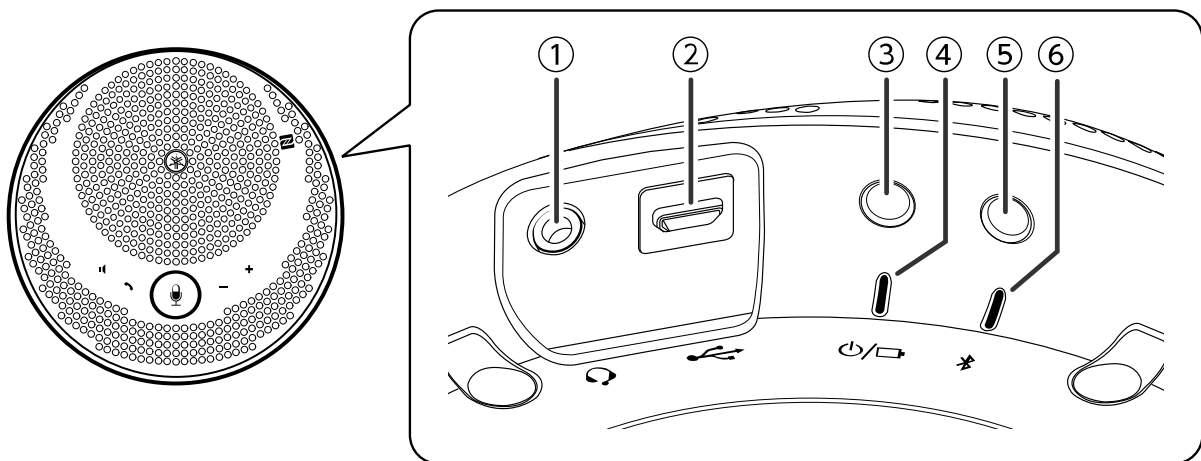

① Headset port ()

Connects to a commercial headset/headphones.

② USB port ()



Connects a computer or a commercial USB power adapter to the product with the supplied USB cable.

③ Power button ()

Turns on the product when pressed for more than 2 seconds. Turns off the product when pressed again for more than 2 seconds.

④ Battery indicator ()

Flashes when the built-in rechargeable battery runs low.

Display	State
 Light off	Charging finished or rechargeable battery level high
 Light on	Charging
 Flashing	The battery level is low

Indicates the remaining battery level when the power button is pressed.



(→ [Checking the Battery Level](#))

⑤ **Bluetooth button ()**

Allows the user to pair the product with, connect the product to, or disconnect the product from a smartphone via Bluetooth.

⑥ **Bluetooth indicator ()**

Indicates the Bluetooth connection status.

Display	State
 Light off	Bluetooth not connected
 Light on	Bluetooth connection finished
 Flashing	Waiting for Bluetooth pairing

2.3. Bottom

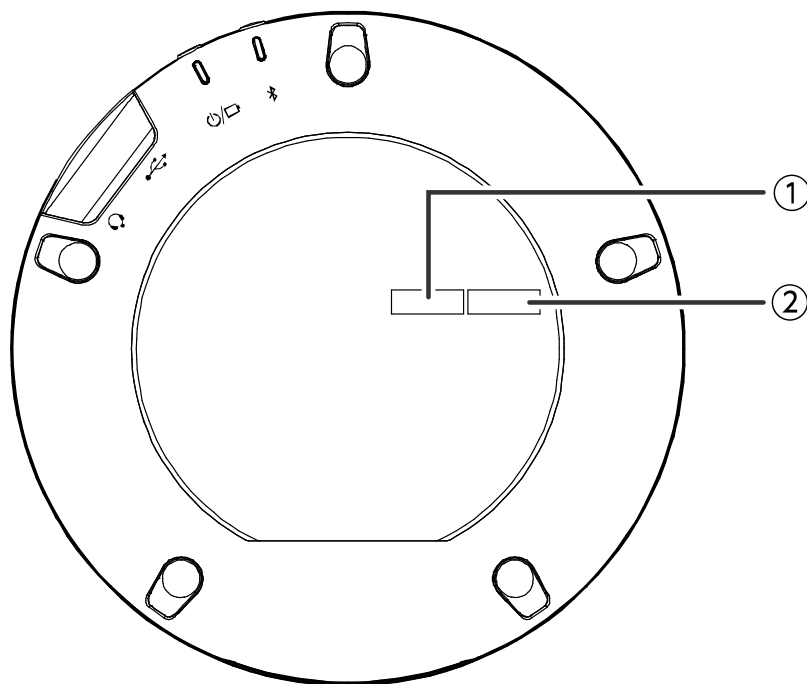

① **Serial number**

Provides the serial number, which is used to manage and categorize the product.

② **Production year and month**

Provides the year and month of production of the product.

3. Preparation

3.1. Charging

Use the supplied USB cable to transmit power and start charging.

Power can be transmitted by connecting the product to either a computer or a commercial USB power adapter.

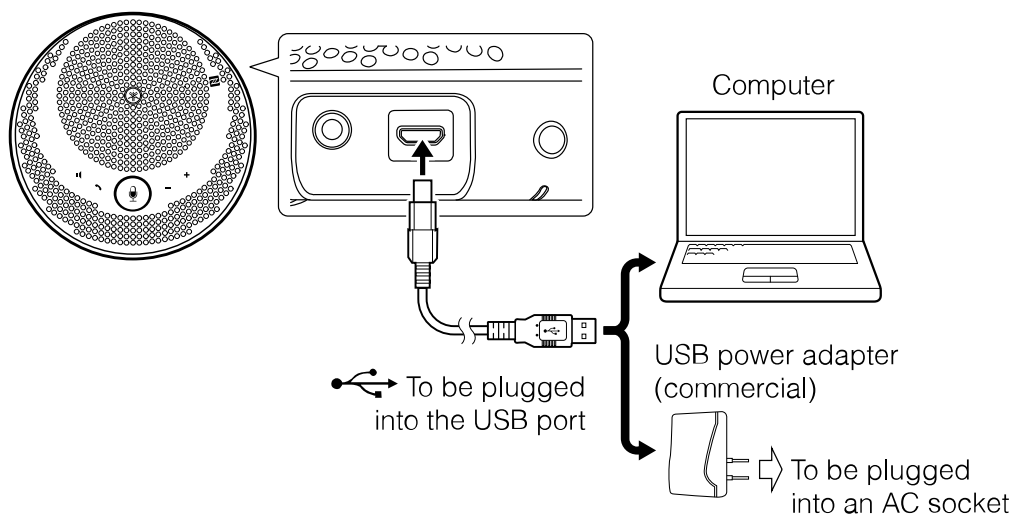

WARNING

- Make sure to first read the safety precautions for the USB power adapter you are going to use.
- Use the USB power adapter that is capable of supplying power compliant with the USB standard.

Output voltage	4.8V to 5.2V
Output current	At least 0.5 A



Note

- A full charge requires 4 to 6 hours.

3.2. Installing

Install near the people who are speaking in order to clearly capture their voices.

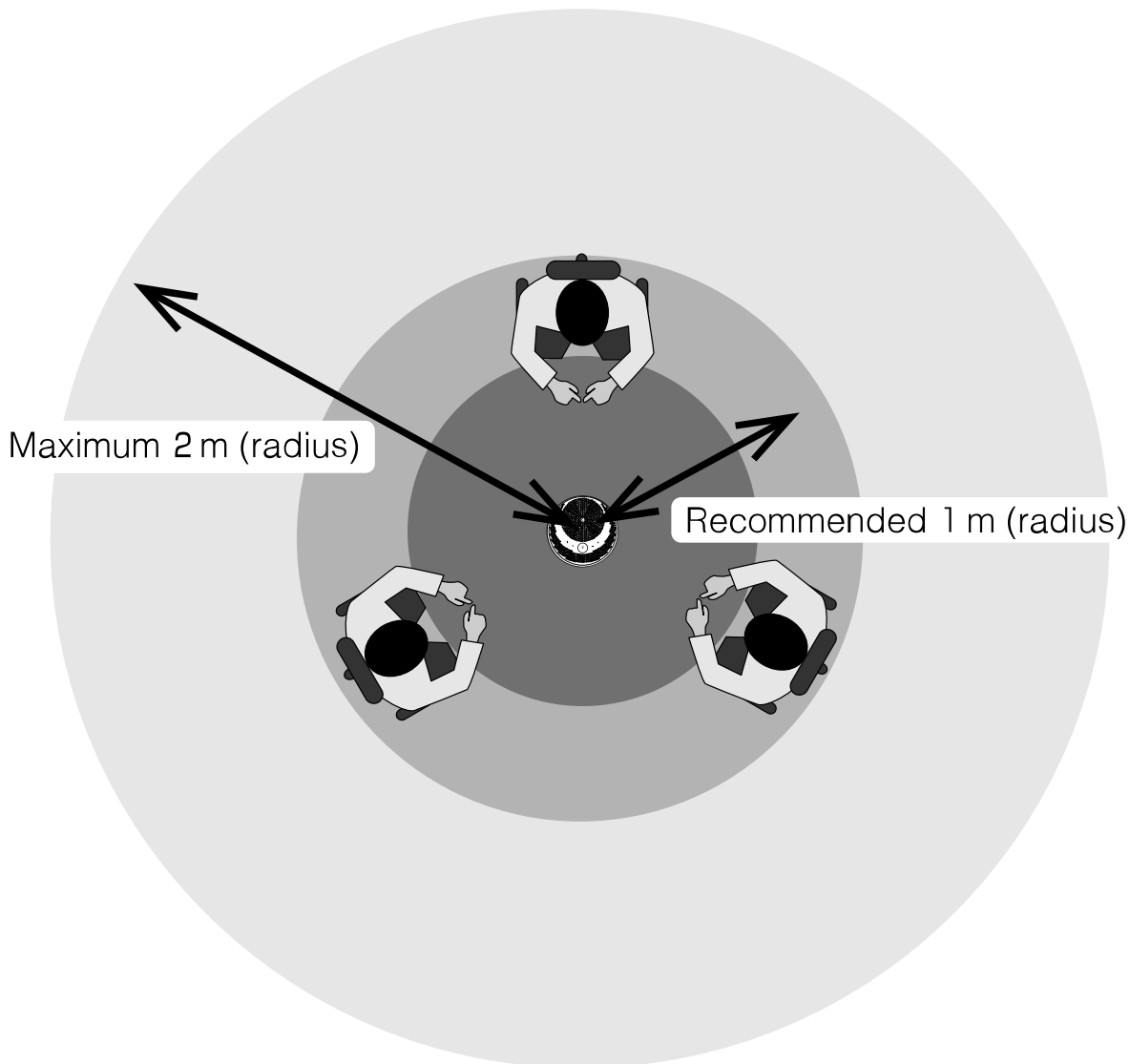

 Note

- Do not install near noise sources (computer cooling fans, projectors, etc.). These may cause degradation of the audio quality for the other person on the call.

3.3. Connecting a headset/headphones

You can communicate using a headset/headphones by connecting a commercial headset/headphones equipped with a mini-jack to the headset port on this product.

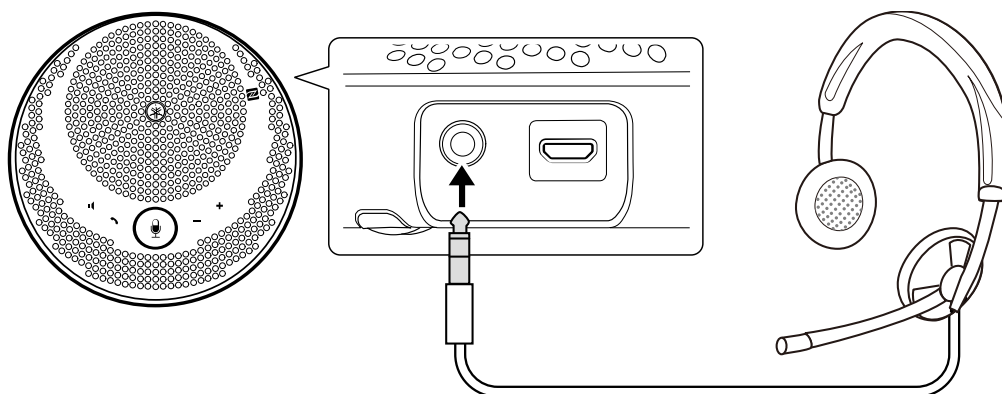

 Note

- When a headset is connected, the microphone and speaker on this product are automatically disabled.
- When a pair of headphones is connected, although the microphone on this product remains enabled, the speaker is automatically disabled.

 CAUTION

- Do not use a headset/headphones at large volumes for long periods of time. This may cause hearing impairment.

3.4. Connecting a Smartphone via Bluetooth

This product can be paired/connected via Bluetooth with a smartphone running iOS or Android. After connecting, check whether or not the audio is output correctly.

 Note

- The supported versions of iOS and Android are listed on the following website.
<https://uc.yamaha.com/>
- Only one smartphone can be connected via Bluetooth to this product at the same time.

3.4.1. Pairing

Pairing is the operation of mutually registering the pairing information of Bluetooth devices to be connected. Pairing needs to be performed when connecting a smartphone by Bluetooth for the first time and when pairing information has been deleted.

 Note

- This product is able to pair with a maximum of 8 smartphones. When pairing with the 9th smartphone succeeds, the pairing information for the smartphone where the date and time of Bluetooth connection is the oldest is deleted.
- When connecting this product to another smartphone via Bluetooth, disconnect the connection with that smartphone before performing pairing.

1. Press and hold the Bluetooth button () for 2 seconds or more.
The Bluetooth indicator flashes to indicate the pairing waiting state.

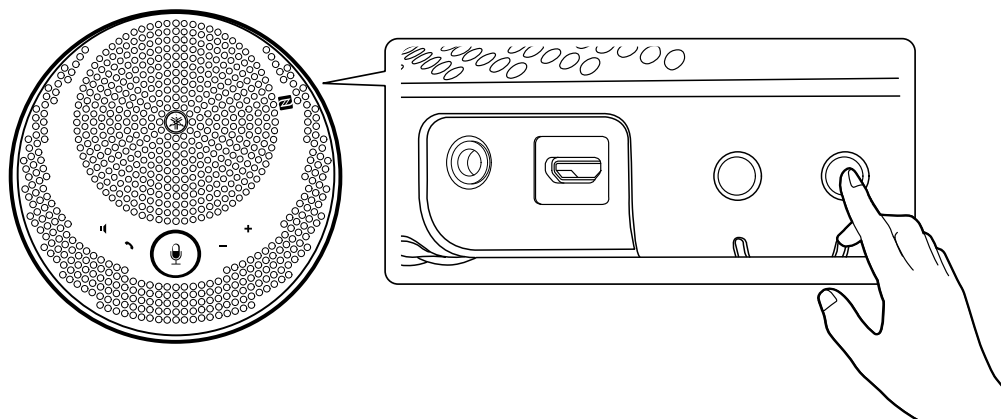

2. Pair the product with the smartphone.
 Enable Bluetooth on the smartphone you are connecting and pair with the "YVC-200 Yamaha". When required to enter a passkey, enter the numerals "0000".

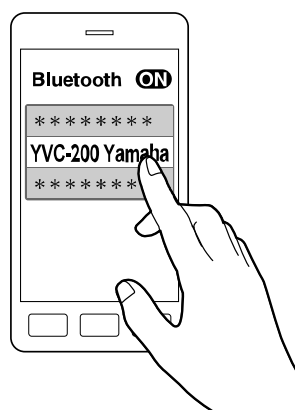

Note

- Check on the smartphone that pairing is complete, and if it did not succeed, perform the pairing again.
- Normally, connection occurs at the same time as pairing.
- In the pairing wait state, if you press the Bluetooth button () or if 90 seconds passes without pairing completion, the pairing wait state ends.

3.4.2. Connecting

This section describes how to connect to a paired smartphone via Bluetooth.

1. Perform any of the following operations.
 - a. Press the Bluetooth button () on this product.
 If there are multiple paired smartphones, the smartphone that was connected to this product last is connected.
 - b. Perform the Bluetooth connection operation in the smartphone.
2. A notification sound plays and the Bluetooth indicator lights up when complete.

3.4.3. Pairing/Connecting via NFC

For smartphones that run Android and support NFC, Bluetooth pairing and connection can be made at the same time by using the NFC function.

Note

- The supported versions of Android are listed on the following website.
<https://uc.yamaha.com/>
- Turn on the NFC function of the smartphone in advance.

1. Hold the smartphone over the N-Mark ().

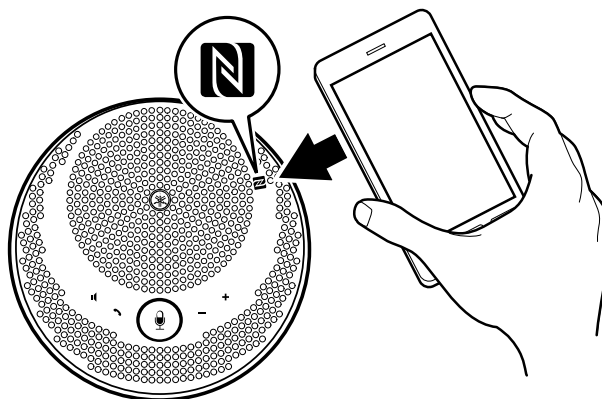



2. A notification sound plays and the Bluetooth indicator lights up when complete.

Note

- The operation might not function or the distance that can be connected may differ between smartphones.
- If the smartphone has a case, etc., remove the case.
- If you are unable to perform the pairing and connection, change the position where you are holding the smartphone.

3.4.4. Disconnecting

This section describes how to disconnect from a smartphone connected via Bluetooth.

1. Perform any of the following operations.
 - a. Press the Bluetooth button ().
 - b. Perform the Bluetooth disconnection operation in the smartphone.
 - c. Hold the smartphone over the N-Mark () (for smartphones running Android that support NFC).
2. A notification sound plays and the Bluetooth indicator turns off when complete.

Note

- Even when the power of this product is turned off, the Bluetooth is disconnected.

3.5. Connecting a Computer via USB

Connect a computer running Windows or macOS using the included USB cable.
After connecting, check whether or not the audio is output correctly.

 Note

- The supported versions of Windows and macOS are listed on the following website.
<https://uc.yamaha.com/>

3.5.1. Connecting

Connect this product to the computer using the included USB cable. The product will start up automatically as power is transmitted from the computer.

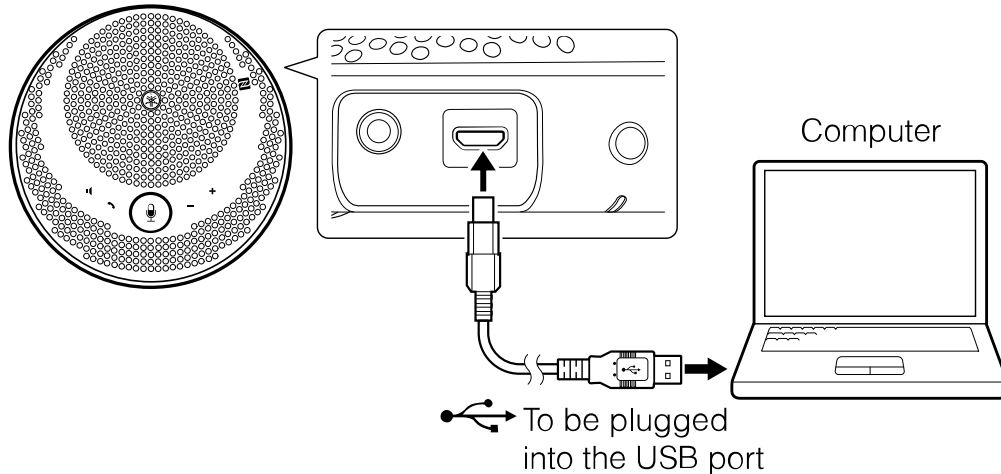
 Note

- Since this product is recognized by computers as a standard USB audio device, there is no need to install a separate USB driver.

3.5.2. Checking if Connected Correctly

Once the connection is finished, use the following procedure to check that the computer correctly recognizes this product.

 Note

- The fields, etc. on the setting screens differ depending on the computer you are using.

On Windows

1. Right-click the speaker icon at the bottom right of the screen and click "Sounds".
The "Sound" screen is displayed.
2. Click the "Playback" tab and check that "Yamaha YVC-200" is set as the default device.
If it is not set as the default device, click "Yamaha YVC-200" and click "Set Default".

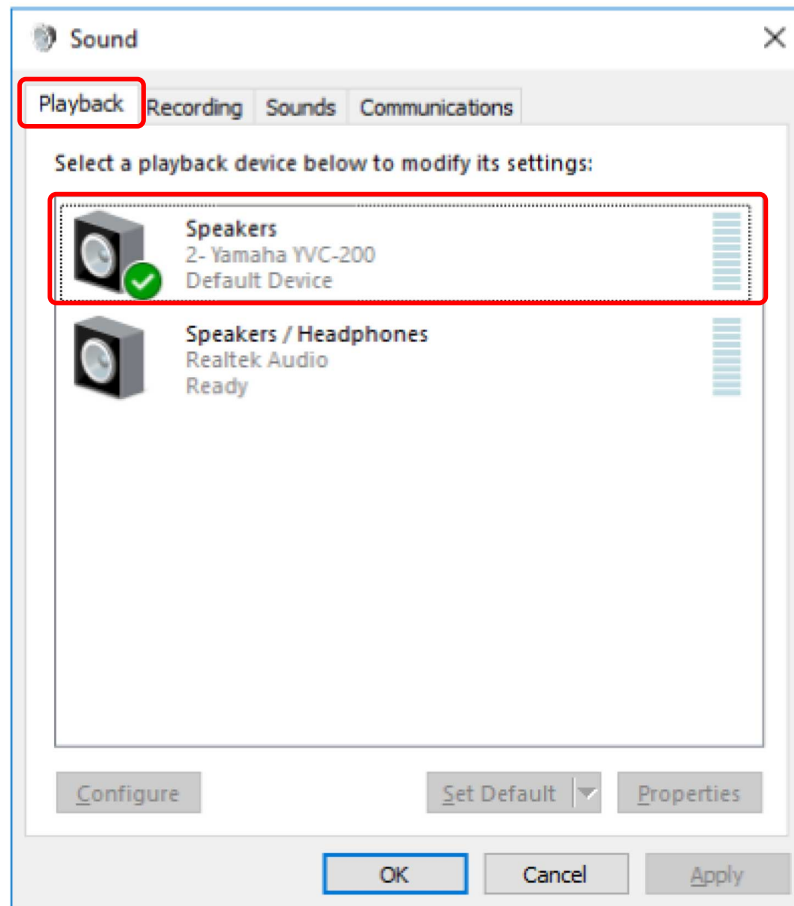

 Note

- Normally, the "Yamaha YVC-200" is automatically set as the default device simply by connecting.

3. Click the "Recording" tab and check that "Yamaha YVC-200" is set as the default device. If it is not set as the default device, click "Yamaha YVC-200" and click "Set Default".

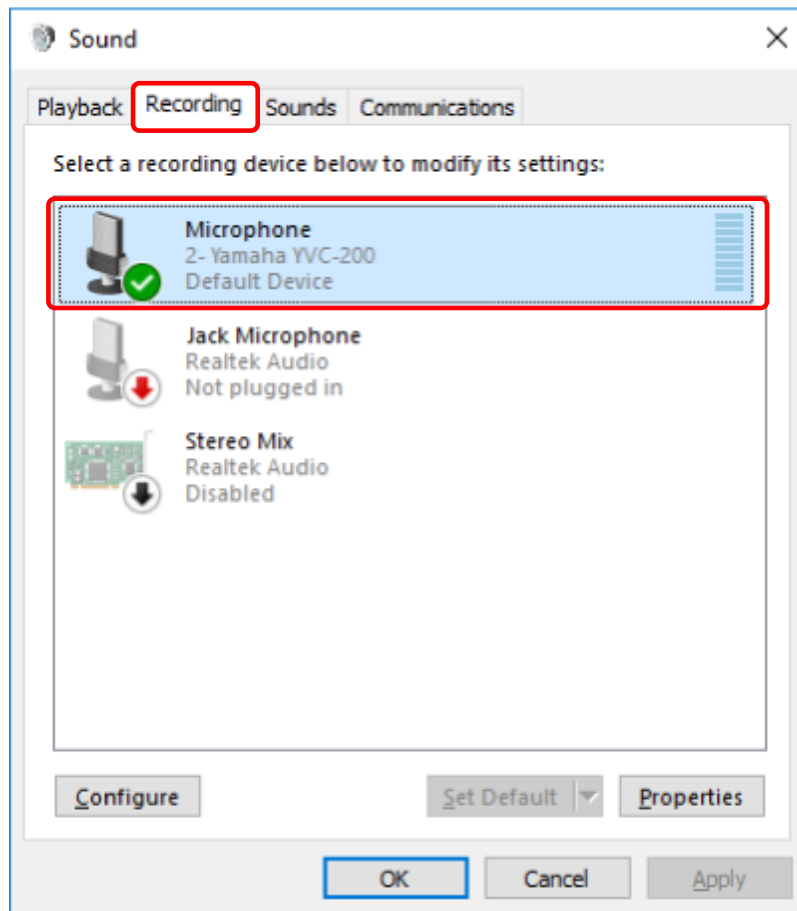

Note

- Normally, the “Yamaha YVC-200” is automatically set as the default device simply by connecting.

On macOS

1. Click  at the top left of the screen, and click “System Preferences” then “Sound”. The “Sound” screen is displayed.
2. Click the “Output” tab and check that “Yamaha YVC-200” is selected in the “Select a device for sound output” field. If it is not select, click “Yamaha YVC-200”.

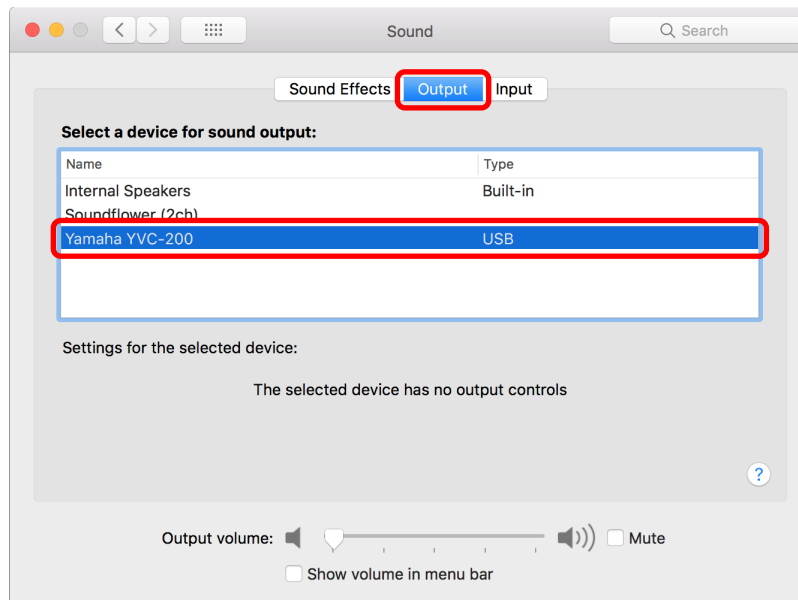

Note

- Normally, the “Yamaha YVC-200” is automatically selected simply by connecting.

3. Click the “Input” tab and check that “Yamaha YVC-200” is selected in the “Select a device for sound input” field.

If it is not select, click “Yamaha YVC-200”.

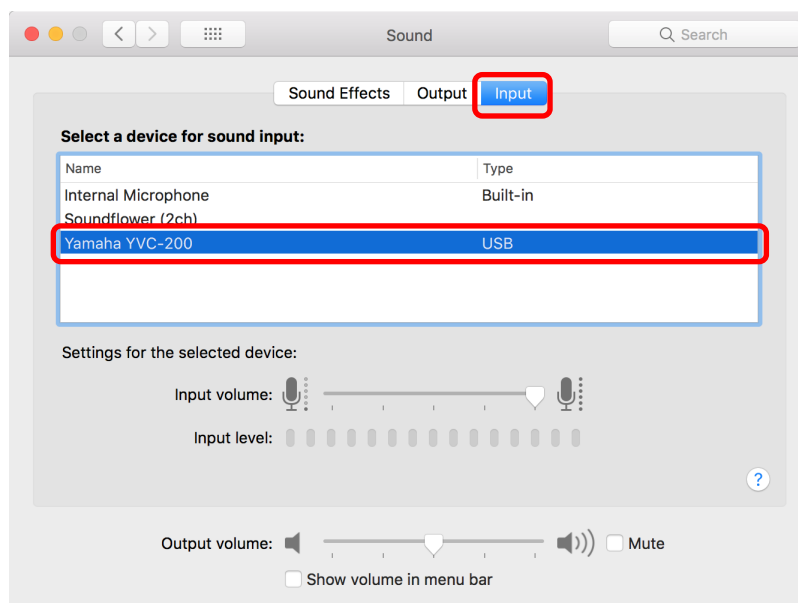

Note

- Normally, the “Yamaha YVC-200” is automatically selected simply by connecting.

3.5.3. Adjusting the Microphone Sensitivity

Depending on your system, the sound may break up or be too quiet at the other caller. If this happens, adjust the microphone sensitivity (input volume).

 Note

- The fields, etc. on the setting screens differ depending on the computer you are using.

On Windows

1. Right-click the speaker icon at the bottom right of the screen and click “Sounds”.
The “Sound” screen is displayed.
2. Click the “Recording” tab, and click “Yamaha YVC-200” and then “Properties”.
The “Microphone Properties” screen is displayed.
3. Click the “Levels” tab and adjust the microphone sensitivity in the “Microphone” field.

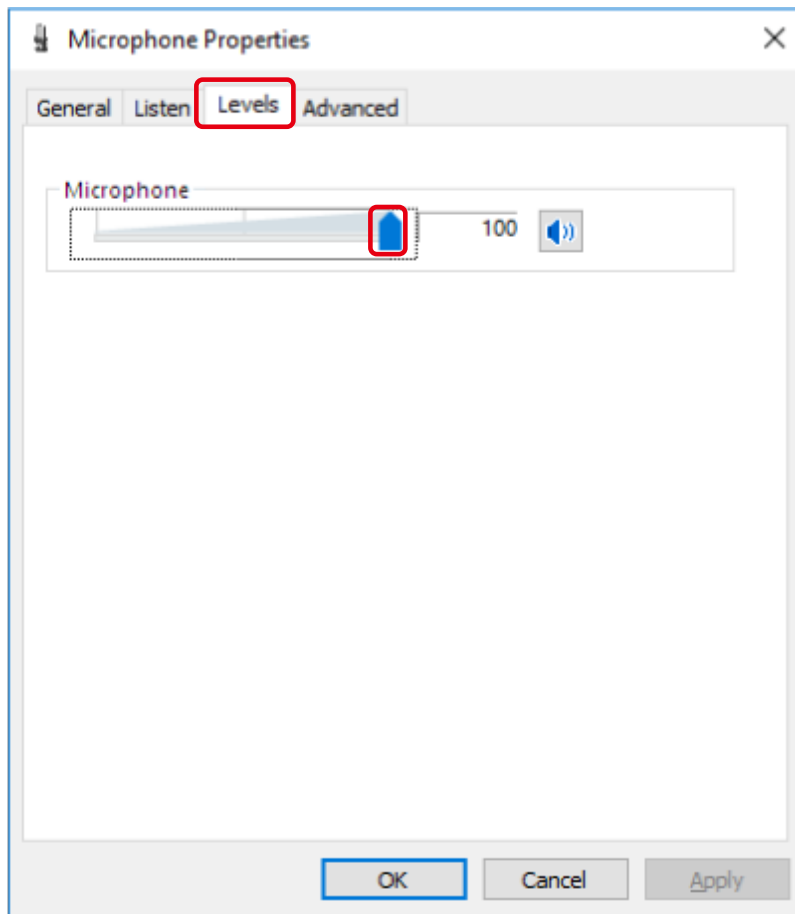

On macOS

1. Click  at the top left of the screen, and click “System Preferences” then “Sound”.
The “Sound” screen is displayed.
2. Click the “Input” tab and adjust the microphone sensitivity in the “Input volume” field.

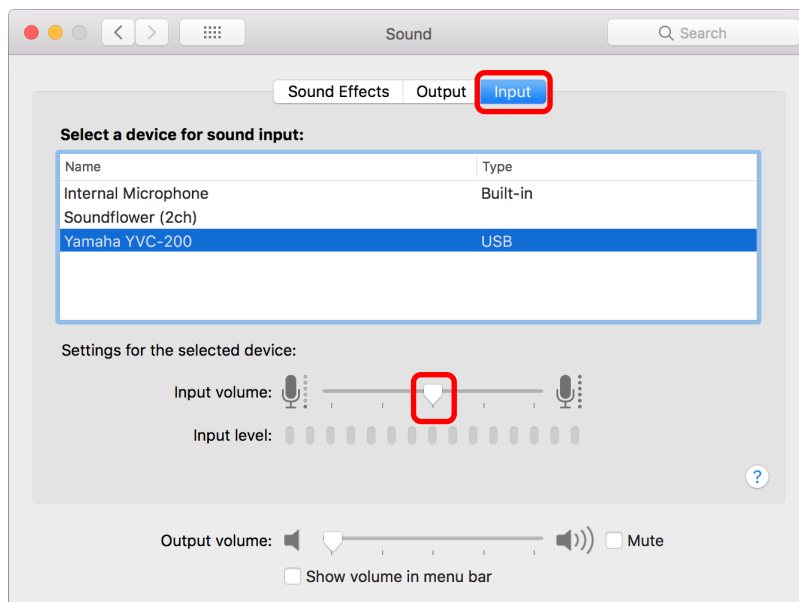

4. Using the Product

4.1. Turning the Power On and Off

Press and hold the power button () for 2 seconds or more to turn the power on. Press and hold again for 2 seconds or more to turn off the power.

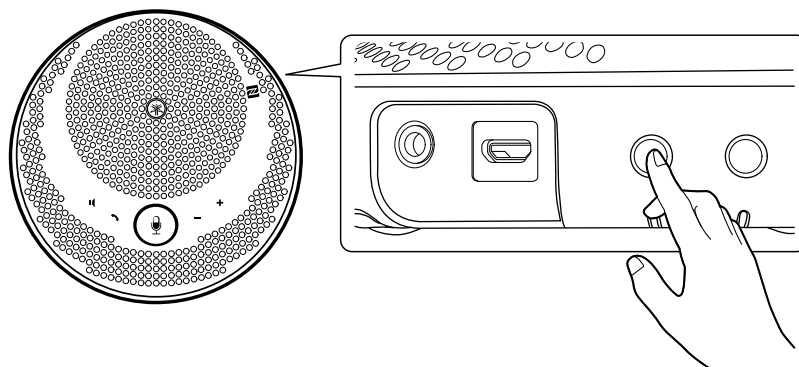

Note

- When not charging, if there is no operation for 3 minutes or more, the power turns off automatically (automatic power off function).

4.2. Adjusting the Speaker Volume

The speaker volume is adjusted by pressing the Volume +/- button (). If you press and hold for 0.5 seconds or more, the volume changes continuously.

Note

- Adjust the speaker volume so that the sound does not break up. Echoes may occur for the other person on the call.
- When connected to a computer via USB cable, when the speaker volume setting is changed on the computer, the speaker volume of this product also changes according to that value.

4.3. Muting/Unmuting the Microphone

You can temporarily stop (mute) the microphone function.

4.3.1. Muting the Microphone

Press the microphone mute button ().
The microphone indicator changes color to red and the microphone is muted.

4.3.2. Unmuting the Microphone

Press the microphone mute button () while the microphone is muted.
The microphone indicator changes color to green and the microphone is unmuted.

4.4. Muting/Unmuting the Speaker

You can temporarily stop the output from the speaker.

4.4.1. Muting the Speaker

Press the microphone mute button ().

The ring part of the microphone indicator turns off and the speaker is muted.

4.4.2. Unmuting the Speaker

Press the speaker mute button () while the speaker is muted.

The ring part of the microphone indicator light up and the speaker is muted.

Note

- If you press the Volume +/- button () while the speaker is muted, the speaker becomes unmuted.
- When connected to a computer via USB cable, when the speaker is muted on the computer, the speaker is also muted on this product.

4.5. Answering an Incoming Phone Call/Ending a Phone Call on a Smartphone

When connected to a smartphone via Bluetooth, you can answer incoming phone calls and end phone calls on the smartphone from this product.

4.5.1. Answering an Incoming Phone Call

When there is an incoming phone call on the smartphone connected via Bluetooth, the microphone indicator flashes rapidly. If you press the call button () at this time, you can communicate using the microphone and speaker on this product.

Note

- When an incoming phone call is answered, the microphone and speaker on the smartphone may become enabled depending on the smartphone. In this case, select YVC-200 in the audio source settings of the smartphone to enable the microphone and speaker of this product.

4.5.2. Ending a Phone Call



You can end a phone call by pressing the call button () while in a phone call.

5. Other Functions

5.1. Checking the Battery Level

You can check the level of the built-in rechargeable battery.

1. Press the power button () while the device is on.
The battery indicator flashes a number of times depending on the battery level.

Indicator display	Number of flashes	Battery level
 x 1	1 time	Approx. 0% to 40%
 x 2	2 times	Approx. 40% to 80%
 x 3	3 times	Approx. 80% to 100%





Note

- The battery indicator flashes continuously when the battery level is low.



5.2. Restoring Factory Default Settings

You can restore the settings to the factory defaults. This also deletes the Bluetooth pairing information.

1. Press and hold the speaker mute button () and the volume + button () at the same time for 5 seconds or more.
Release the buttons after a notification sound plays and the microphone indicator turns off.
2. After approx. 10 seconds, the microphone indicator flashes again when the process is complete.

5.3. Resetting

You can forcefully restart this product.

1. Press and hold the power button () and Bluetooth button () at the same time for 7.5 seconds or more.
Release the buttons after the microphone indicator turns off.
2. The microphone indicator flashes again when the process is complete.

5.4. Updating the Firmware

The functions of this product are continuously improved by our company.

Download the firmware for this product from the following website to use the latest functions.

<https://uc.yamaha.com/resources/support/>

6. Troubleshooting

6.1. Before Contacting Support

Read this manual to check whether the problem can be resolved.

If the problem still continues, please contact the retailer or dealer who you purchased the product from.

6.2. Problems with Bluetooth Connections

Symptom	Cause	Solution
Unable to perform pairing with a smartphone via Bluetooth	The smartphone you are trying to pair contains pairing information for a different YVC-200.	Delete the pairing information for the other YVC-200 and then perform pairing. (→ Pairing)
Unable to connect to smartphone via Bluetooth	The smartphone is not paired via Bluetooth.	Perform pairing. (→ Pairing)
	Another smartphone is connected via Bluetooth (the Bluetooth indicator is alight).	Disconnect the connection with the other smartphone and then connect. (→ Disconnecting , Connecting)

6.3. Problems with Phone Call Audio Quality

Symptom	Cause	Solution
Sound is inaudible or too low	Speaker mute is active.	Unmute the speaker. (→ Unmuting the Speaker)
	The speaker volume is low.	Increase the speaker volume. (→ Adjusting the Speaker Volume)
	A speaker other than the YVC-200 is selected in the communication app on the computer connected via USB.	Select the YVC-200 in the speaker device settings of the communication app.
	The YVC-200 is not selected in the audio source settings of the smartphone connected via Bluetooth.	Select the YVC-200 in the audio source settings. (→ Pairing)
	Microphone mute is active on the other caller.	Unmute the microphone on the other caller.
	The microphone sensitivity on the other caller is low.	Increase the microphone sensitivity on the other caller.
Sound is inaudible or too low at the other caller	Microphone mute is active.	Unmute the microphone. (→ Unmuting the Microphone)
	The microphone sensitivity on the computer connected via USB is low.	Increase the microphone sensitivity. (→ Adjusting the Microphone Sensitivity)
	A microphone other than the YVC-200 is selected in the communication app on the computer connected via USB.	Select the YVC-200 in the microphone device settings of the communication app.
	Speaker mute is active on the other caller.	Unmute the speaker on the other caller.
	The speaker volume on the other caller is low.	Increase the speaker volume on the other caller.

Symptom	Cause	Solution
The sound breaks up or is loud	The speaker volume is high.	Decrease the speaker volume. (→ Adjusting the Speaker Volume)
	The microphone sensitivity on the other caller is high.	Decrease the microphone sensitivity on the other caller.
The sound at the other caller breaks up or is loud	The microphone sensitivity on the computer connected via USB is low.	Decrease the microphone sensitivity. (→ Adjusting the Microphone Sensitivity)
	The speaker volume on the other caller is high.	Decrease the speaker volume on the other caller.
Echoes or howling can be heard	There is a problem with the device structure or usage environment at the other caller.	Review the device configuration and usage environment at the other caller.
Echoes or howling can be heard at the other caller	The computer connected via USB has not correctly recognized this product.	Check the computer settings. (→ Connecting a Computer via USB)
	A speaker and microphone other than the YVC-200 is selected in the communication app on the computer connected via USB.	Select the YVC-200 in the speaker device settings and microphone device settings of the communication app.
Noise can be heard	There is a problem with the device structure or usage environment at the other caller.	Review the device configuration and usage environment at the other caller.
Noise can be heard at the other caller	There is a device nearby that is generating noise.	Move as far away from the noise source as possible.

6.4. Other Problems

Symptom	Cause	Solution
The power turns off during use	The automatic power off function activates.	Turn on the power again. (→ Turning the Power On and Off)
	The battery level is low.	Perform charging. (→ Charging)
The microphone indicator flashes red during startup	A fault was detected in the software or hardware.	Ask the store where you purchased this product for repair.
The battery indicator is flashing and the product will not start.	The device has not been used for a long time and will take a long time to charge.	Continue charging until starting is complete (approx. 10 minutes).

Manual Development Group
© 2018 Yamaha Corporation
Published 08/2018
HS-A0