

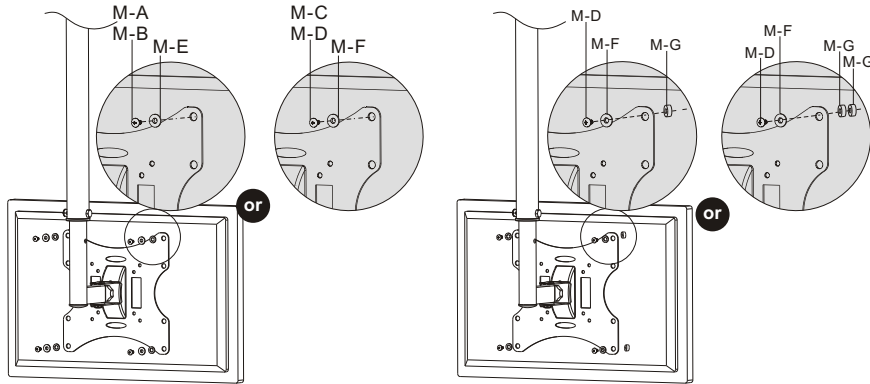

6. Installing the Display

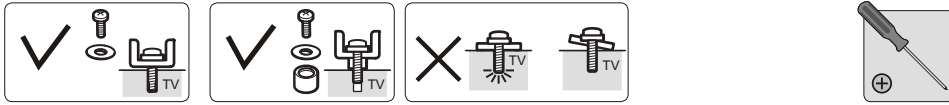

Note: Choose the appropriate screws, washers and spacers (if necessary) according to the type of screen. Lift the display and match the holes on your display with the holes on the mount. Secure your display to the mount by tightening screws.

Tighten all screws but do not over tighten.

7. Adjustment

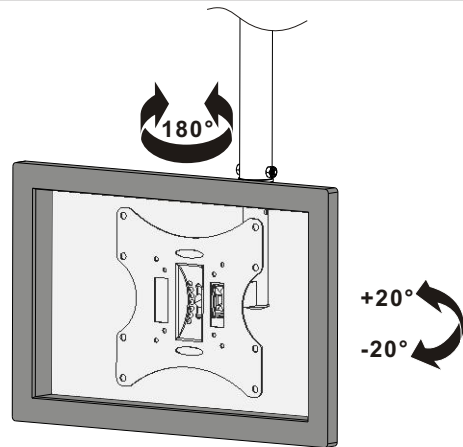

Use the tilt adjusting knob to adjust your display to the desired angle then tighten it.

Maintenance

- Check that the bracket is secure and safe to use at regular intervals(at least every three months).
- Please contact your dealer if you have any questions.



Premium Mount Inc
7300 Bolsa Ave., Westminster, CA 92683 -
Phone: 714-766-6303

INSTALLATION MANUAL

LCD Ceiling Mount

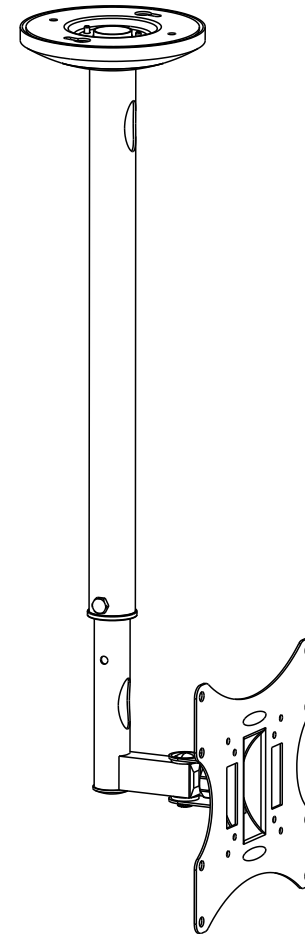

CAUTION: DO NOT EXCEED RATED LISTED WEIGHT. SERIOUS INJURY OR PROPERTY DAMAGE MAY OCCUR!

CMK-01



75x75/100x100
200x100/200x200



ISSUED: FEB. 2013

NOTE: Read the entire instruction manual before you start installation and assembly.

WARNING

- Do not begin the installation until you have read and understood all the instructions and warnings contained in this installation sheet. If you have any questions regarding any of the instructions or warnings, please contact your local distributor.
- This mounting bracket was designed to be installed and utilised **ONLY** as specified in this manual. Improper installation of this product may cause damage or serious injury.
- This product should only be installed by someone with good mechanical ability who has basic building experience and fully understands this manual.
- Make sure that the supporting surface will safely support the combined weight of the equipment and all attached hardware and components.
- If mounting to wooden joist ceiling, make sure that mounting screws are anchored into the center of the joist. The use of a stud finder is highly recommended.
- Always use an assistant or mechanical lifting equipment to safely lift and position the equipment.
- Tighten screws firmly, but do not over tighten. Over tightening can cause damage to the items, This greatly reduces their holding power.
- This product is intended for indoor use only. Using this product outdoors could lead to product failure and personal injury.

Component Checklist

IMPORTANT: Ensure that you have received all parts according to the component checklist prior to installation. If any parts are missing or faulty, telephone your local distributor for a replacement.

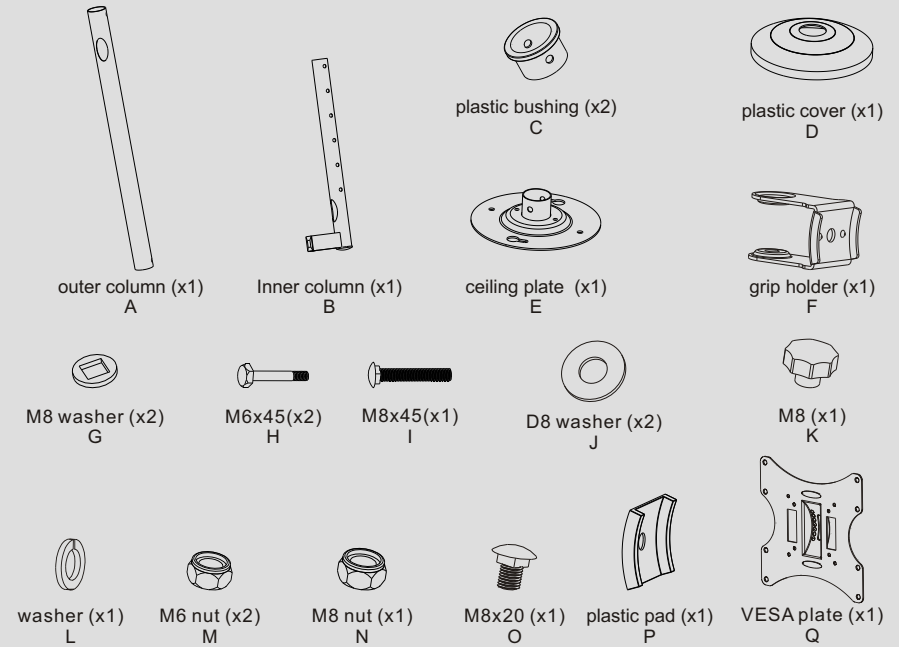

Package M

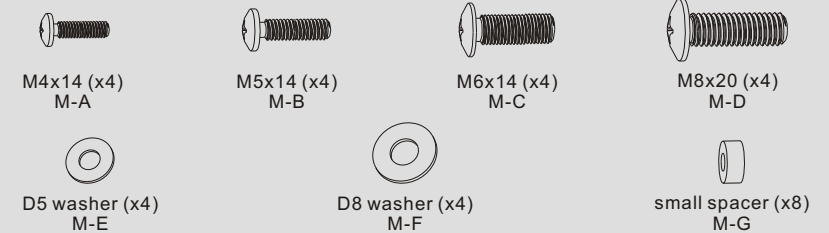

Package W

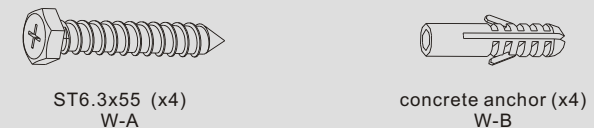

1a. For Wooden Joist Ceiling Mounting

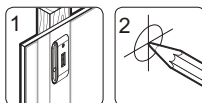
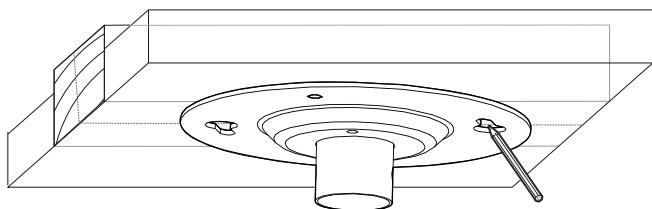
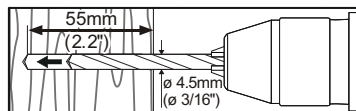

1 Find and mark the exact location of mounting holes

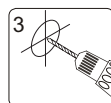

2 Drill two pilot holes

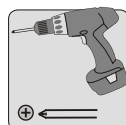
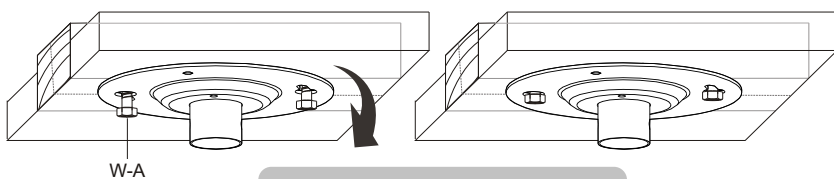
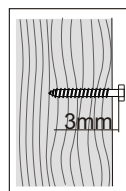
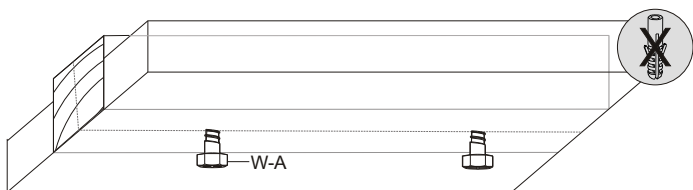

Screw the ceiling plate onto the ceiling

Hang the ceiling plate so that the screws fit into the keyhole openings. Turn the ceiling plate into place and then tighten the screws.

! WARNING

- Make sure that mounting screws are anchored into the center of the joist. The use of a stud finder is highly recommended.
- Installers are responsible to provide hardware for other types of mounting situations.
- Installers must verify that the supporting surface will safely support the combined weight of the equipment and all attached hardware and components.

1b. For Solid Brick and Concrete Mounting

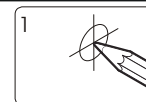
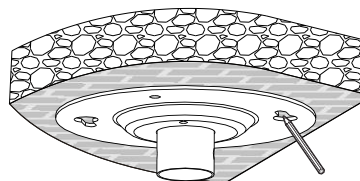
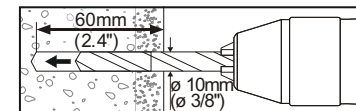

1 Mark the exact location of mounting holes

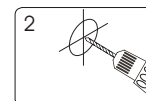
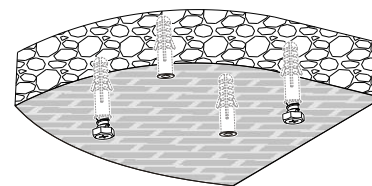
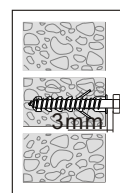

2 Drill four pilot holes

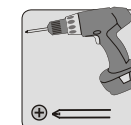
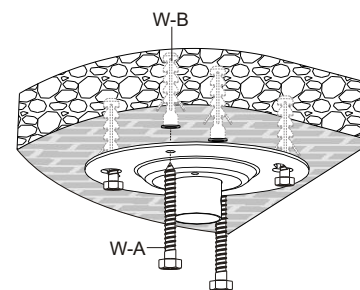
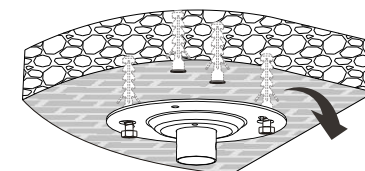

Screw the ceiling plate onto the ceiling

Hang the ceiling plate so that the screws fit into the keyhole openings. Turn the ceiling plate into place. Do not tighten screws at this time. Fix the ceiling plate using the two other screws and then tighten all the screws!

! WARNING

Installers must verify that the supporting surface will safely support the combined weight of the equipment and all attached hardware and components.

2. Installing the Outer Column to the Ceiling Plate

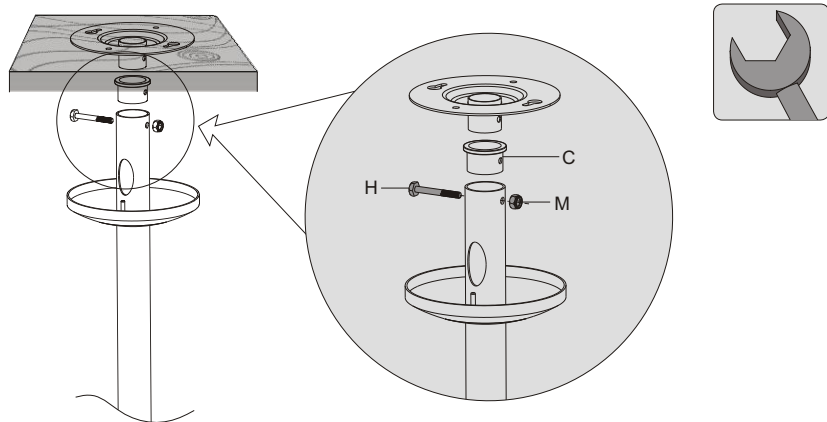

3. Installing the Inner Column and Routing Cables

Run the power cable through columns.

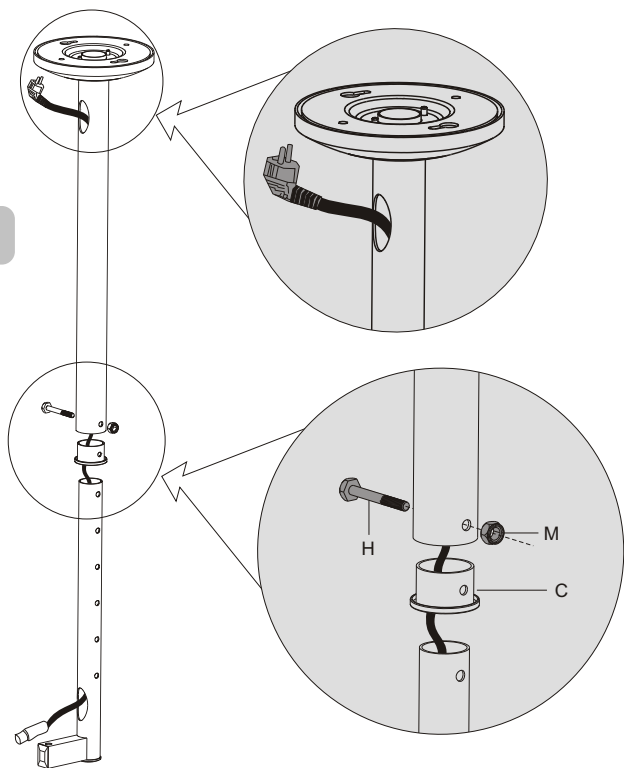

Insert plastic bushing and inner column into the outer column and fix them at the desired height using the correct combination of screw and nut.

4. Assembling the VESA Plate

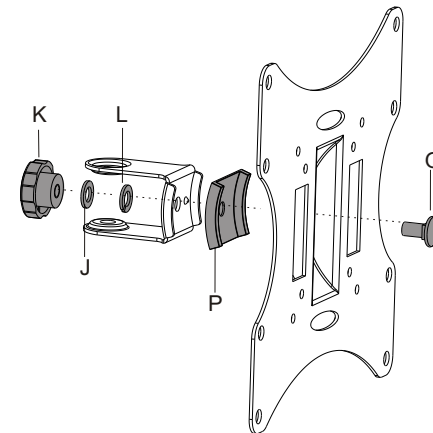

5. Installing the VESA Plate

