



**Yale® Assure Lock®  
Keypad Deadbolt  
Installation and Programming Instructions  
(YRD216)**

This manual will walk you through all the required steps to add your new Yale Assure Lock to your door.

- **Remove Existing Door Hardware**
- **Double Check Door Measurements**
- **Install your Assure Lock**
- **Program your Assure Lock**
- **Add your Assure Lock to your smart home system or August App\***

**Tools Needed**



Standard  
Phillips Head  
Screwdriver

**Tools necessary only for new doors  
or adjusting existing door**



Drill



Pencil



Wood Mortise  
Chisel



Tape  
Measure



Utility Knife



Level

**Before you begin**

**DOWNLOAD  
THE BILT APP**

for step-by-step installation  
instructions & to register  
your product



**BILT.**



\*If purchased with Yale Smart Module or Connected by August Kit

FAILURE TO FOLLOW THESE INSTRUCTIONS COULD RESULT IN DAMAGE TO THE PRODUCT, VOIDING THE FACTORY WARRANTY AND COULD LEAD TO FAILURE OF THE PRODUCT TO PROVIDE ACCESS.



# What's In The Box



**Keypad**



**Keys**

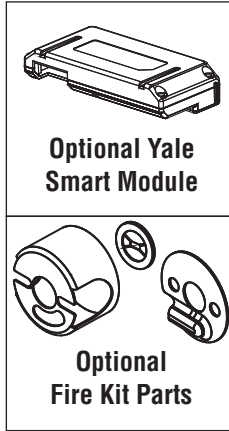

**Optional Yale Smart Module**

**Optional Fire Kit Parts**

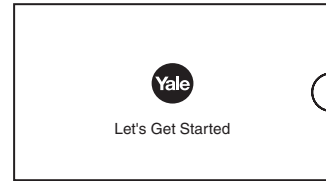

**Installation Guide Envelope**  
(Includes this manual and door checker with template)

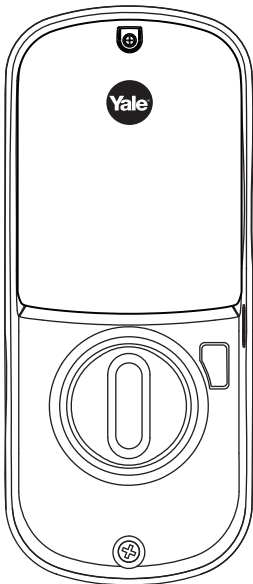

**Inside Lock Assembly**  
(Separates into 3 components)



Loosen screw to remove cover

**Battery Cover**

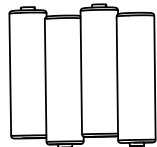

**4 AA Batteries**

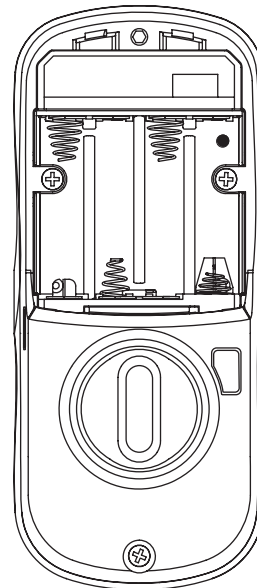

**Inside Lock**

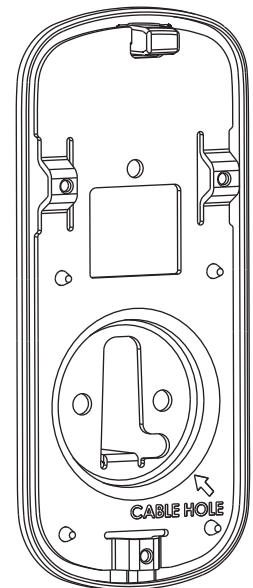

**Mounting Plate**

## Mounting Hardware

The mounting hardware box includes 12 components

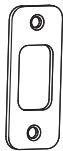

**Strike Plate**

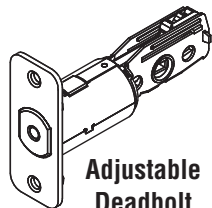

**Adjustable Deadbolt**



**x2**  
Inside Lock Screws



**x4**  
Strike Plate and Deadbolt Screws



**x2**  
Optional Security Strike Plate Screws



**x2**  
Long through bolt for 1-3/4" - 2-1/4" Door Thickness

# 1

## Removing Existing Door Hardware



*Do not discard old lock hardware until Assure Lock has been successfully installed.*

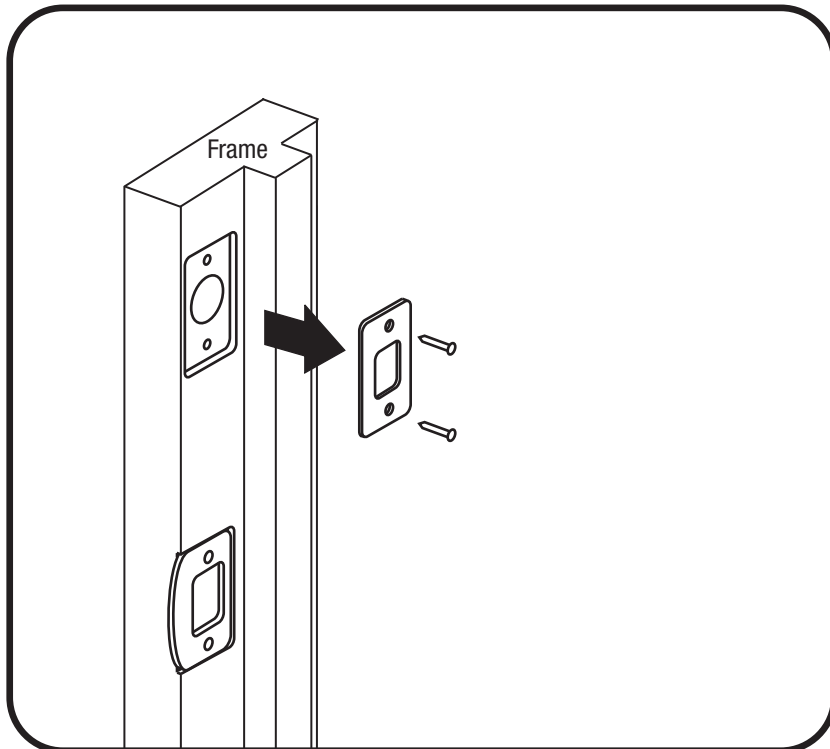
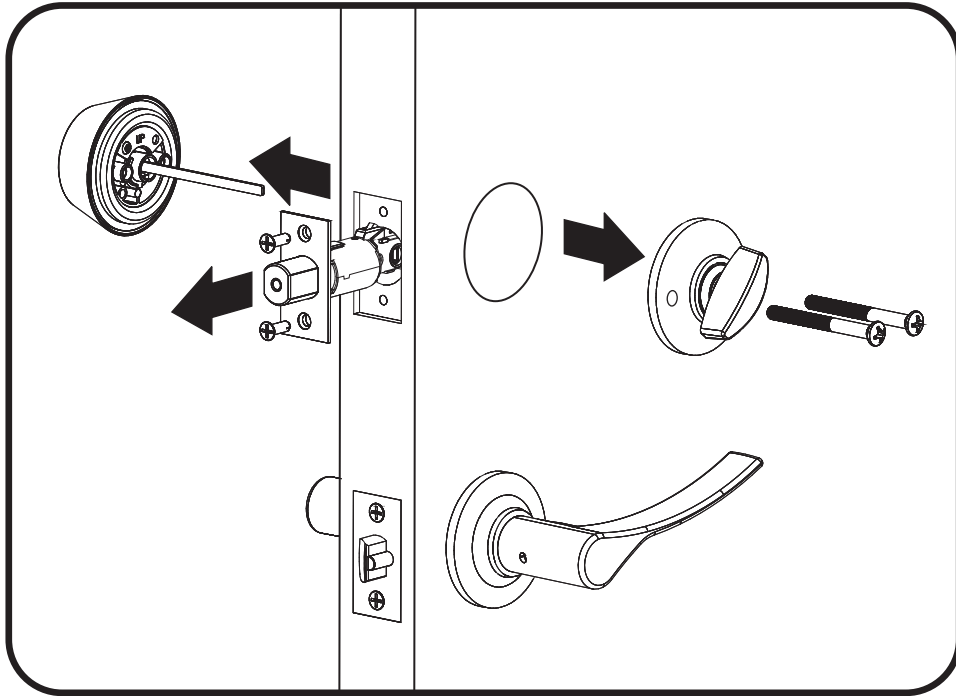

# 2

## Check Door Measurements and Make Adjustments If Needed

### Door Checker

Use door checker from installation guide envelope to verify your door measurements and make any needed adjustments.

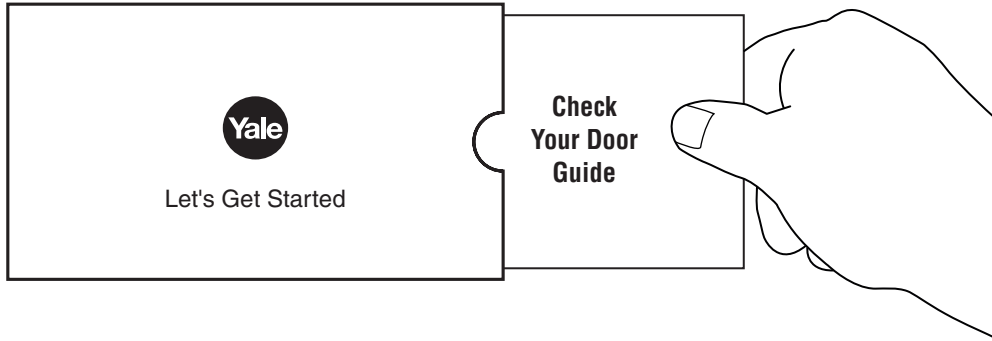

### New Door Marking Template

With door checker, use template from installation guide envelope to prep a new door that has not been predrilled for hardware.

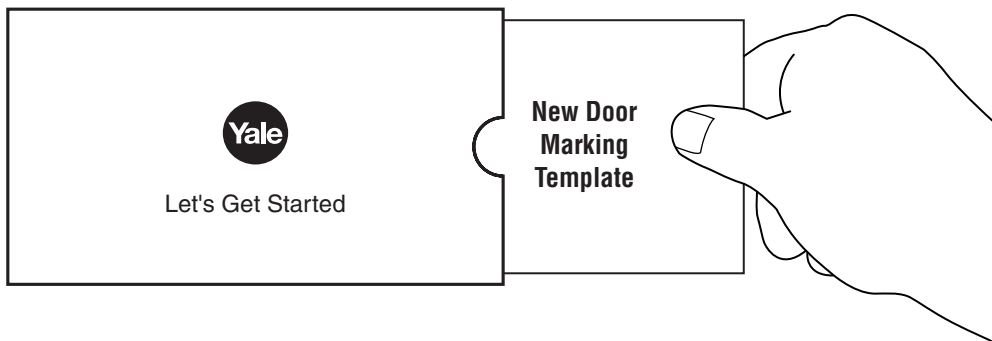

## Installing Optional Fire Cup

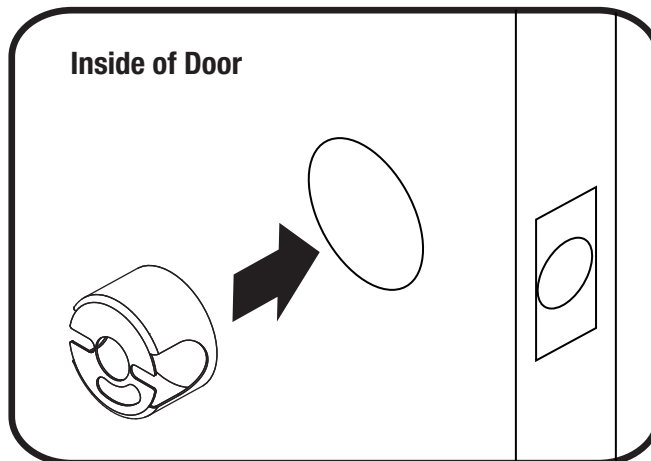

# 3

## Installing Latch & Strike Plate



x2  
Actual Size



Choose standard strike plate screws or security screws.

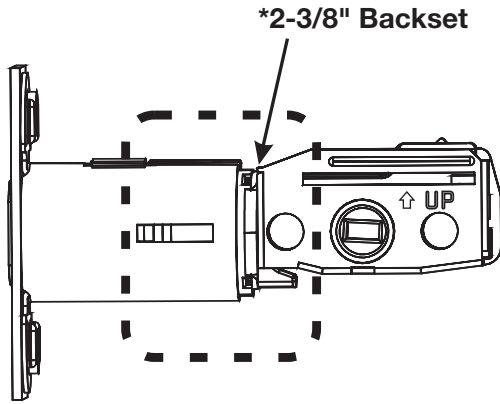

\*Deadbolt latch position is based on backset. Choose position appropriate for your door. Reference Door Checker measurements E and F.

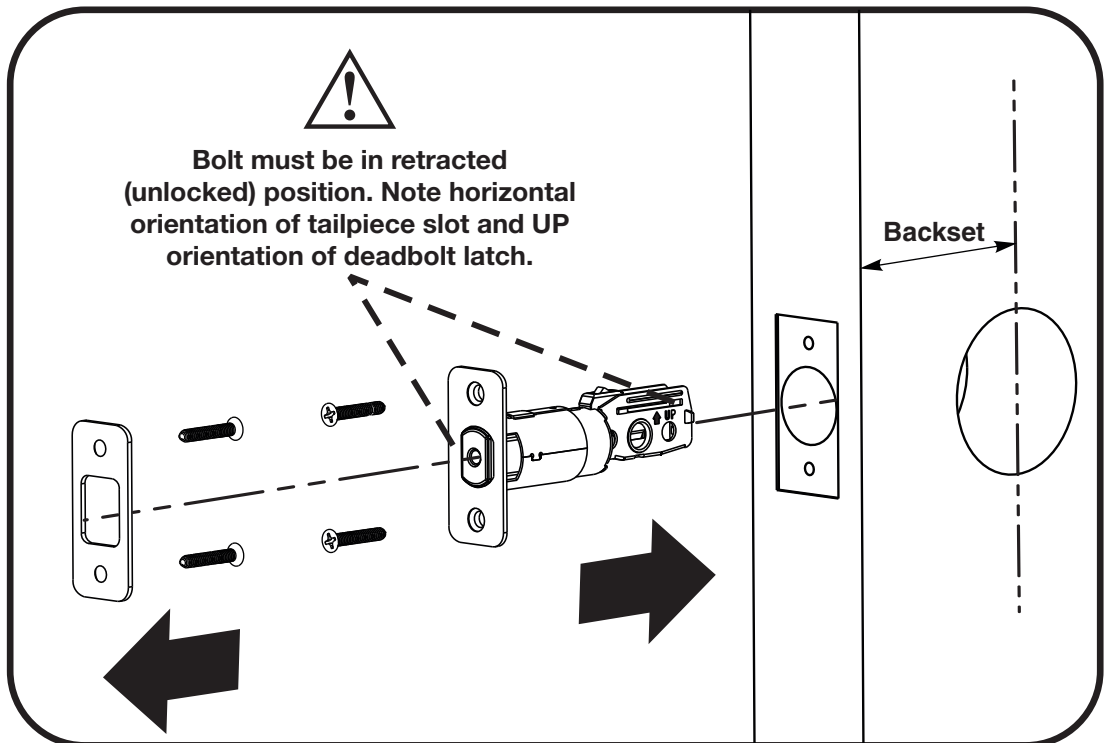
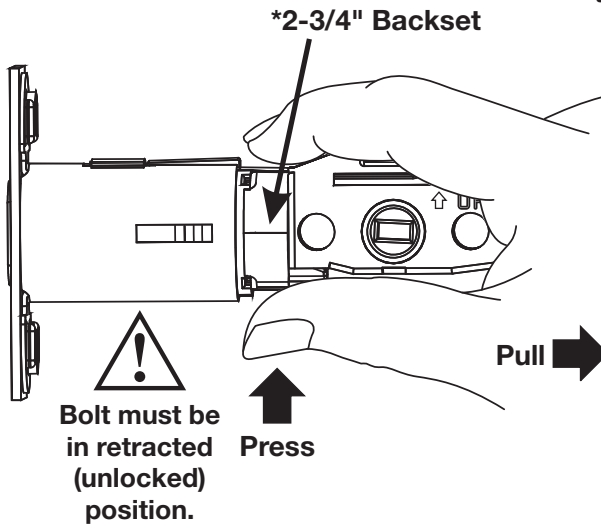

# 4

## Installing Keypad

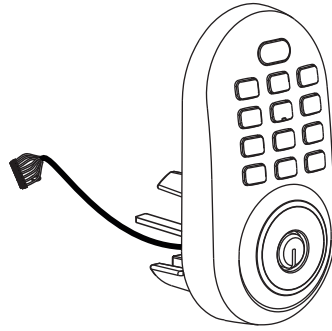

Inside of Door

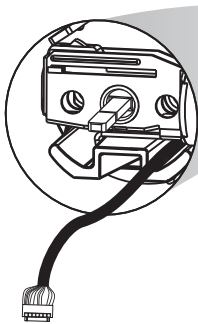

Outside of Door

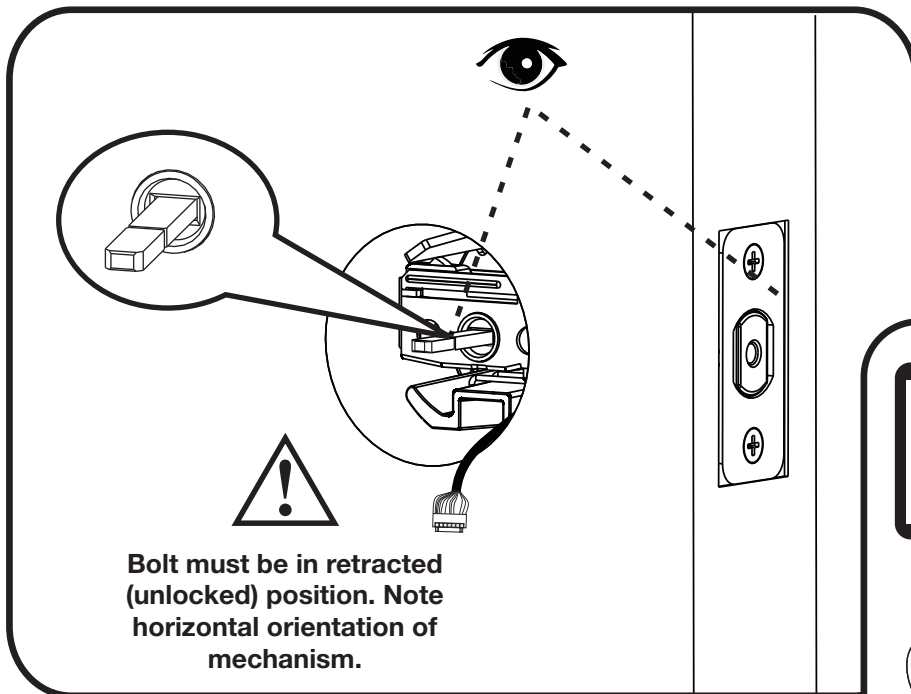
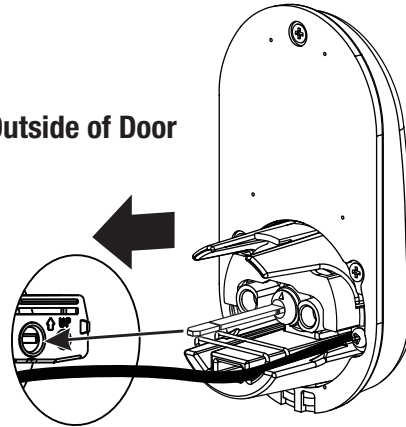

**Bolt must be in retracted (unlocked) position. Note horizontal orientation of mechanism.**

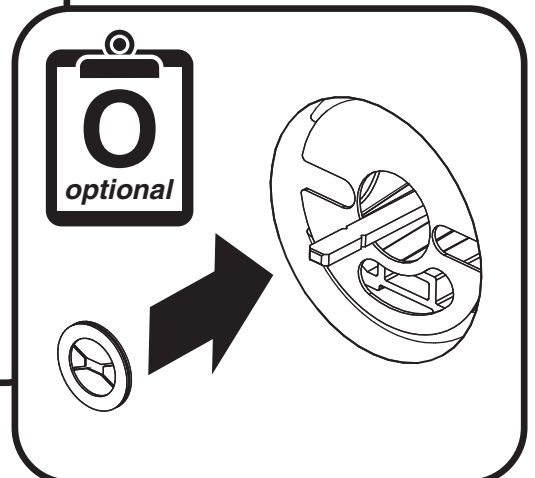

# 5

## Installing Inside Mounting Plate

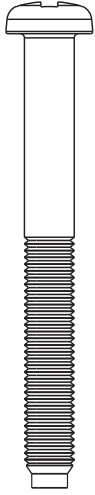

x2

Actual Size

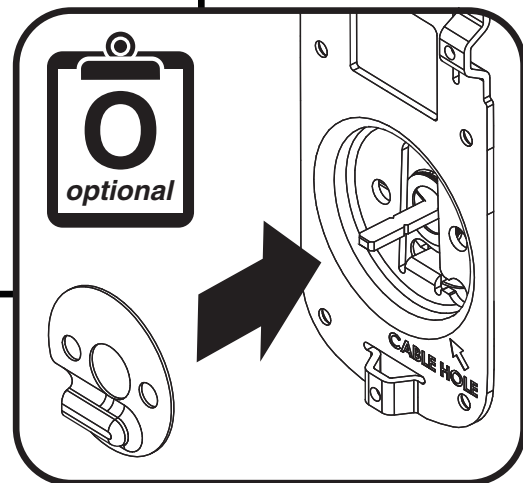
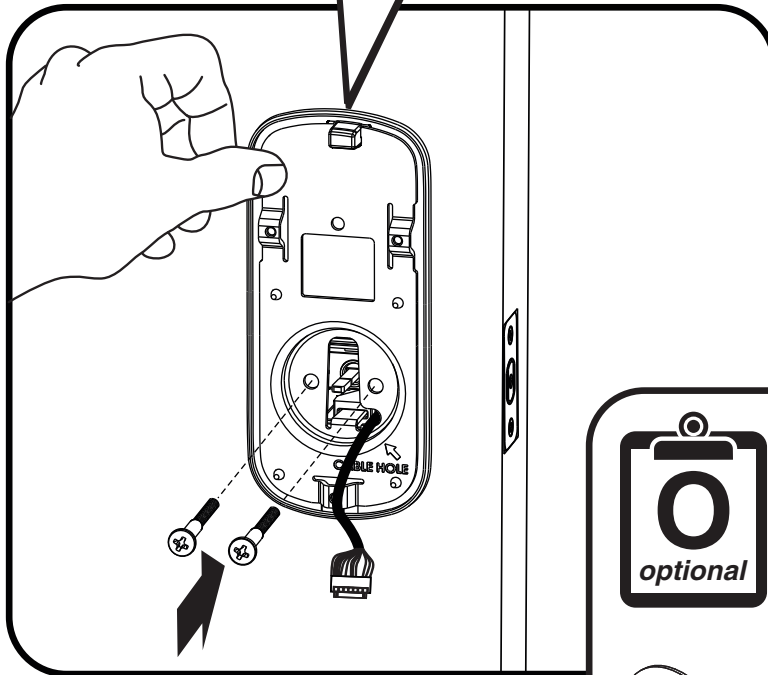
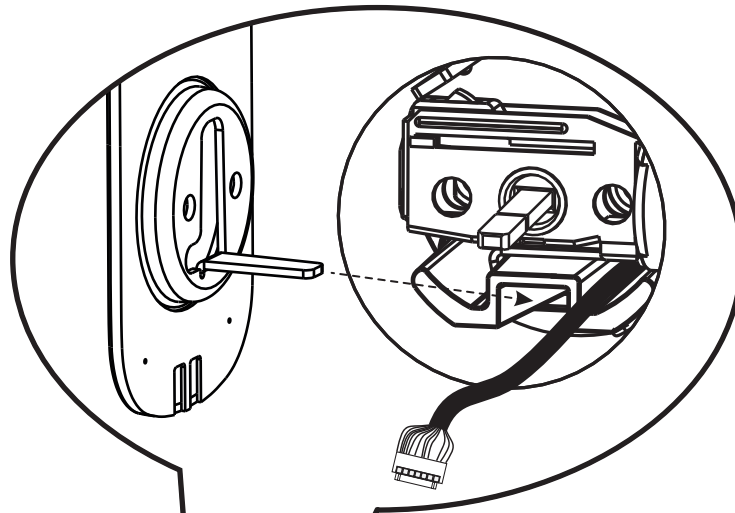

# 6

## Attaching the Cable Assembly

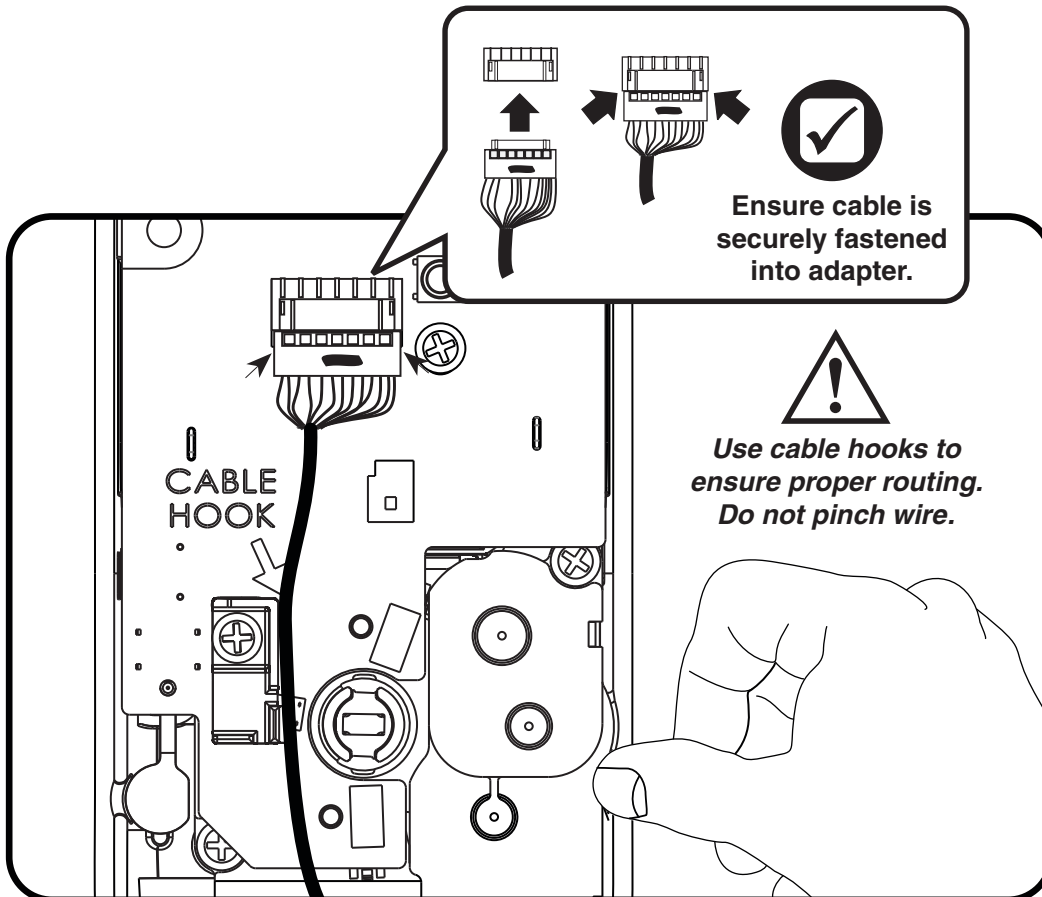
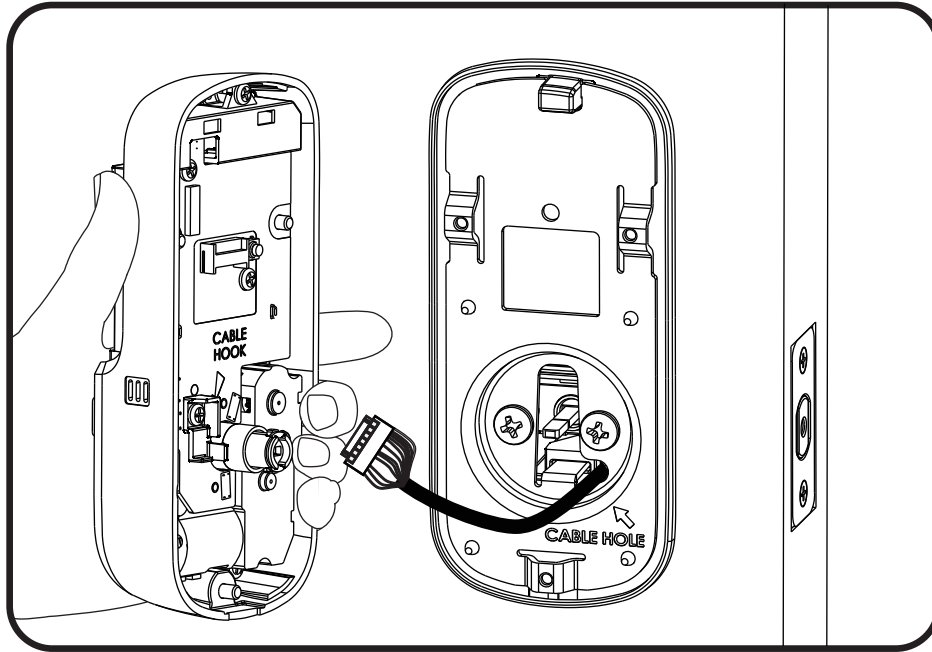



# 7

## Installing Inside Lock



**x3**

Actual Size

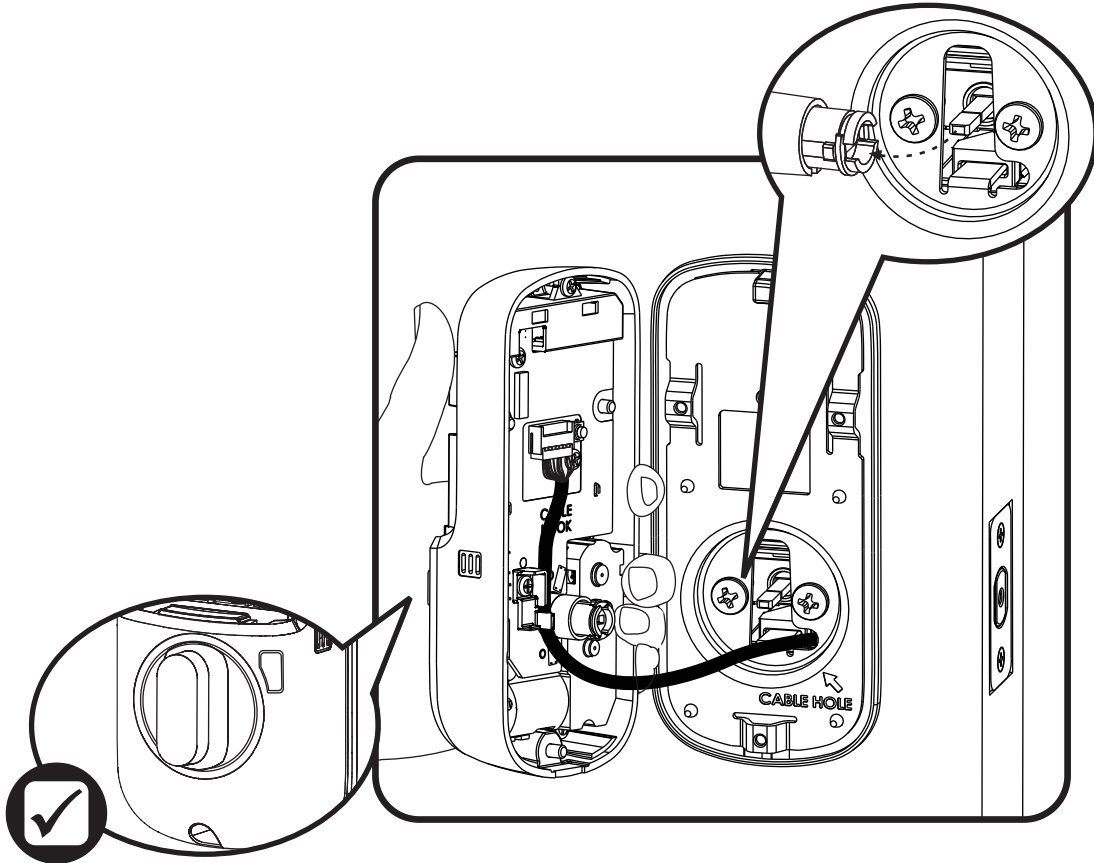

Ensure thumbturn is vertical. If the thumbturn does not move freely, refer to the hardware troubleshooting steps.

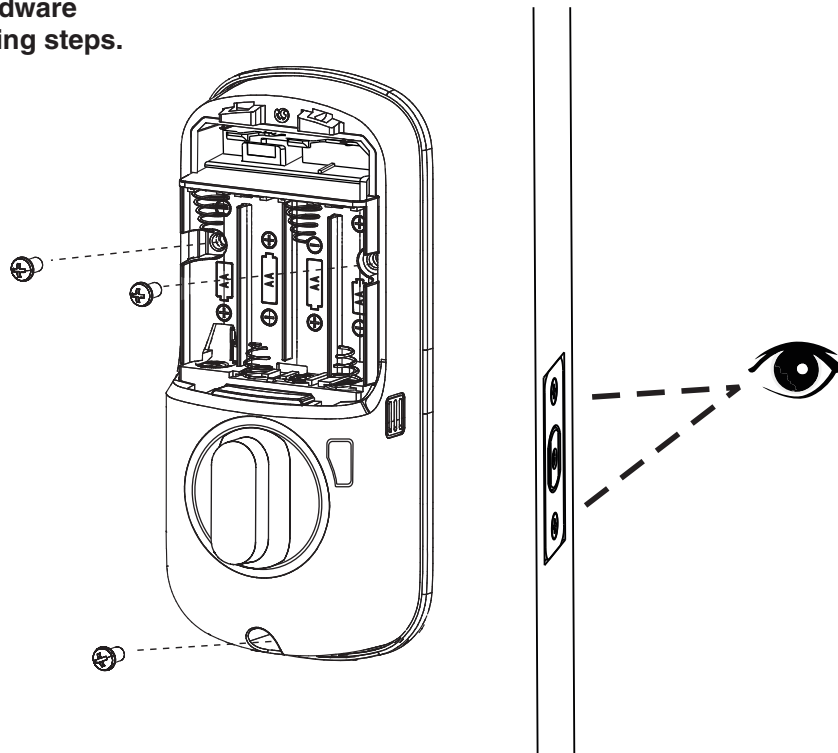



# Testing Mechanical Operation

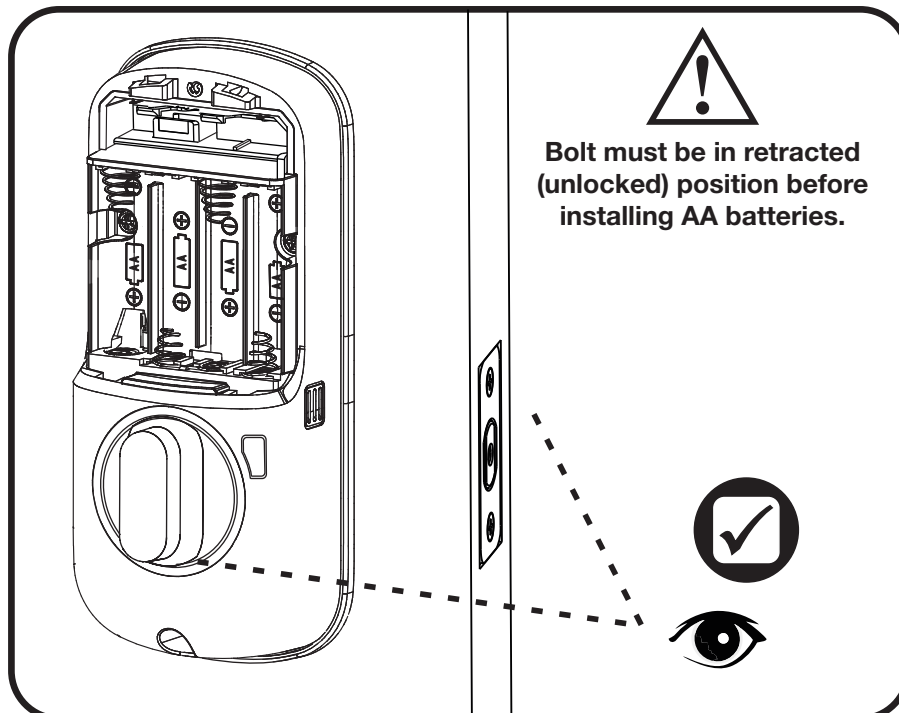
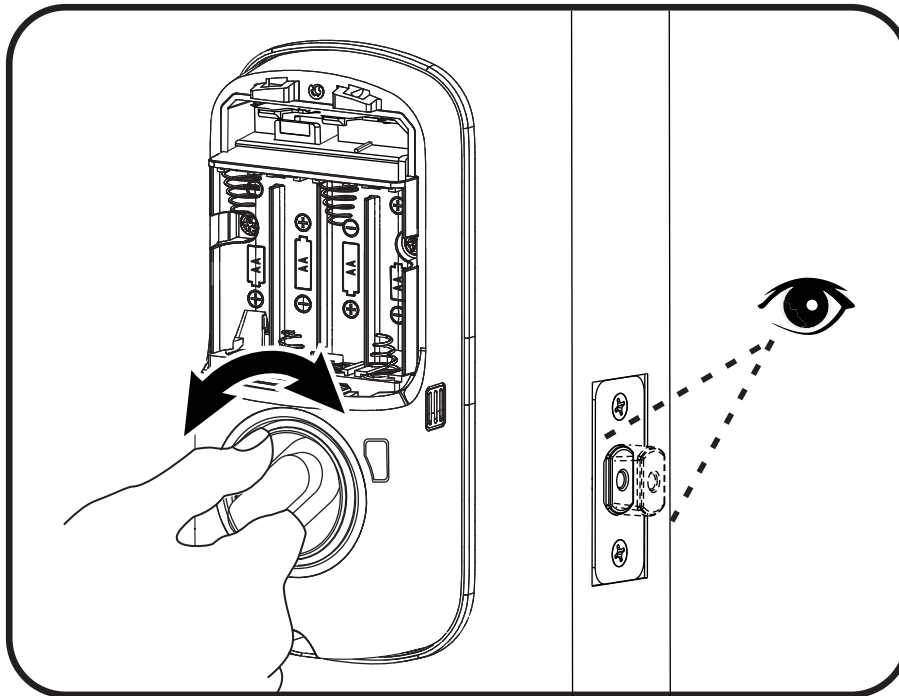

**If thumbturn operation fails, check the installation beginning with Step 5.**



## Testing Mechanical Operation

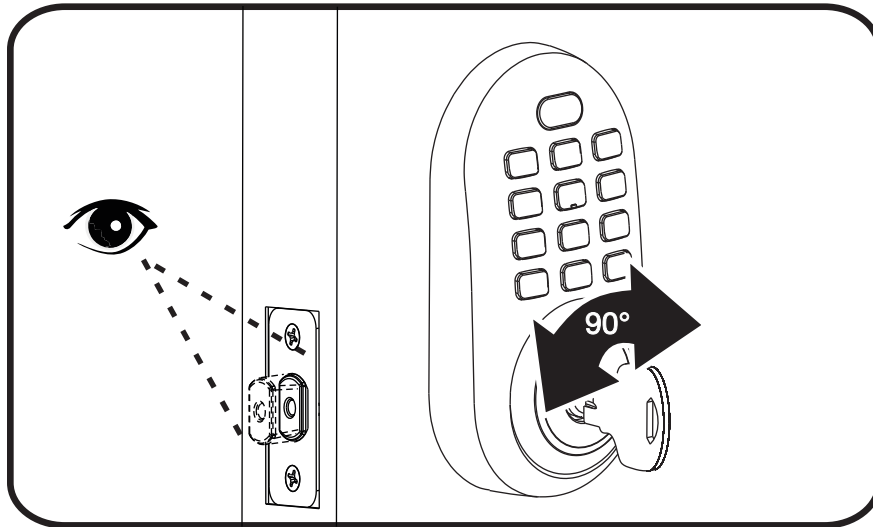

If key operation fails, check the installation beginning with Step 4.

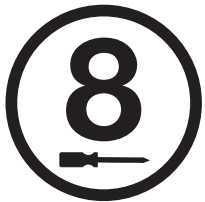

## Installing Optional Yale Smart Module

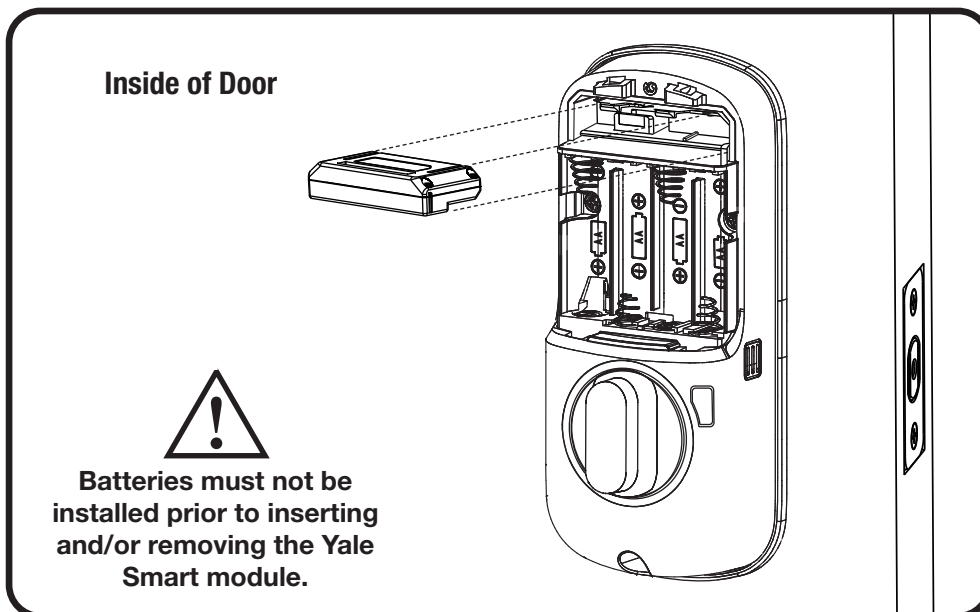

For more information about Yale Smart modules and smart home features visit:  
<https://www.yalehome.com/en/yale/yalehome/residential/yale-smart-home-guide/>

# 9

## Installing Batteries and Cover

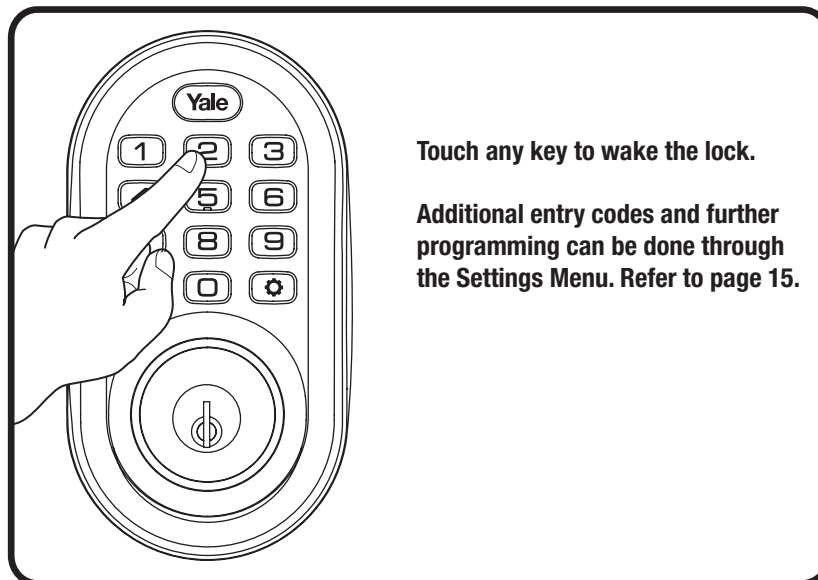
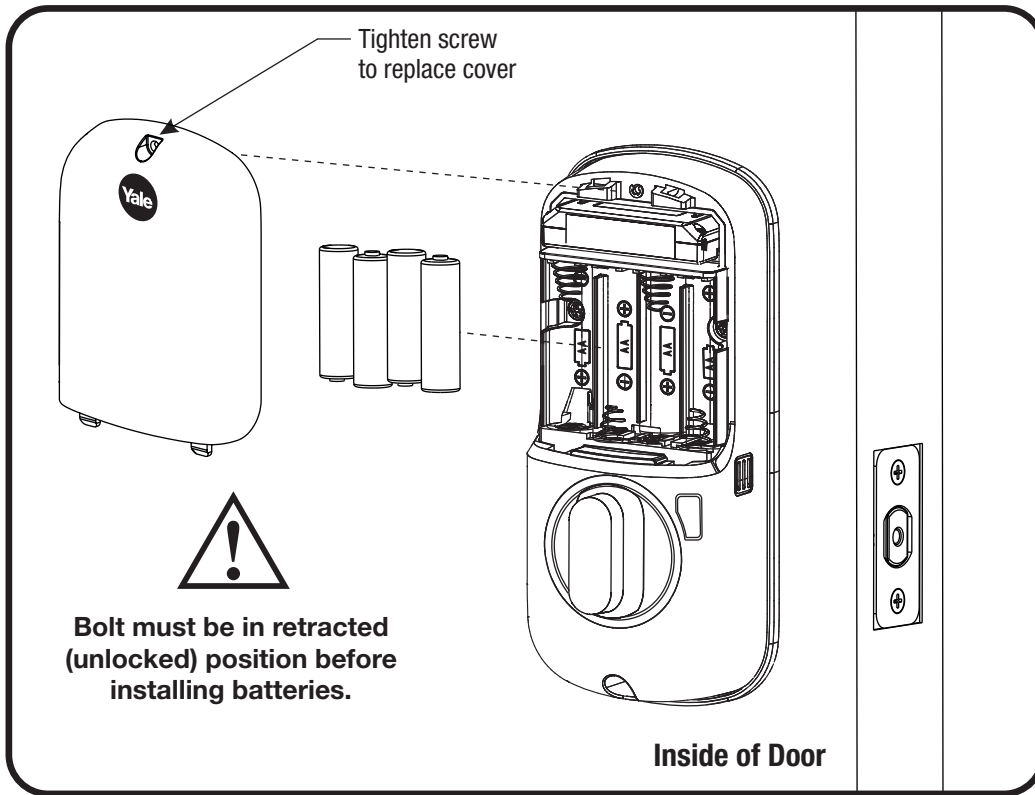

Congratulations, you've installed the Yale® Assure Lock® Keypad Deadbolt (YRD216)!

# Using Your Lock

## Keypad

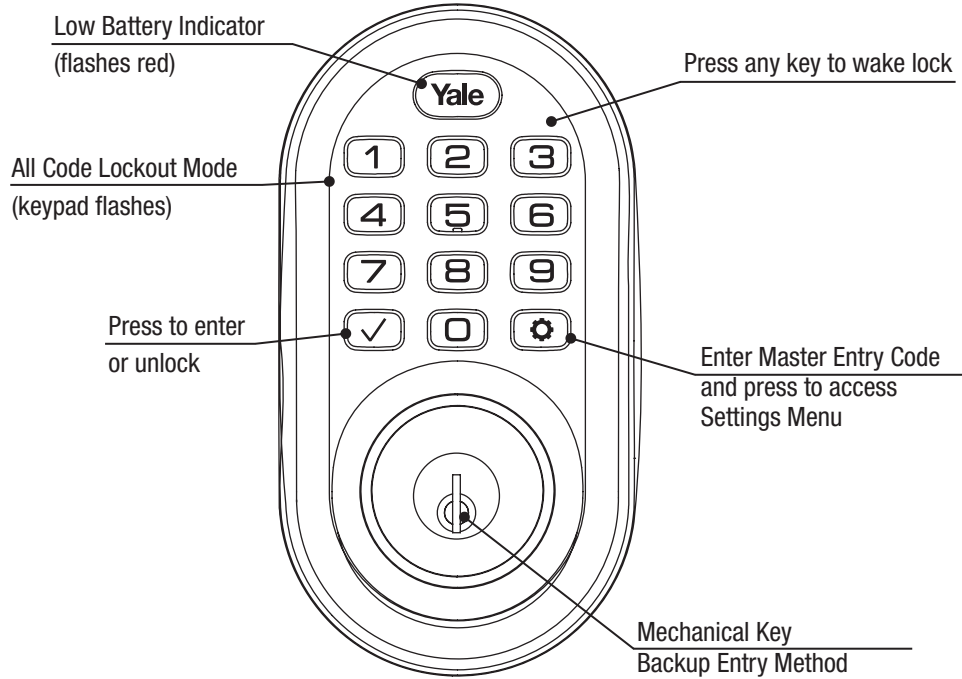

## Inside Lock

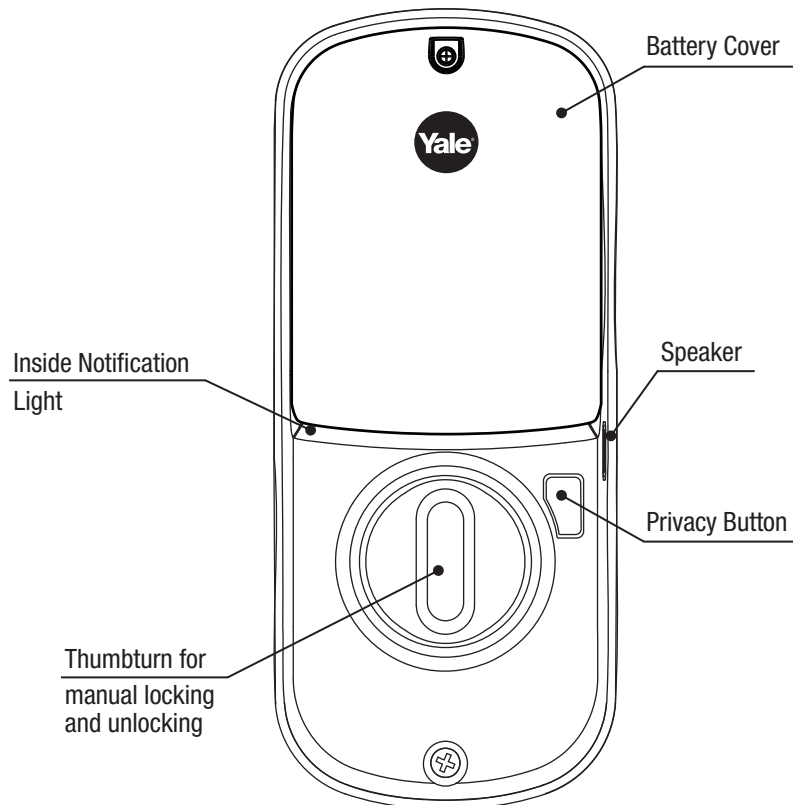

# 1

## Creating Master Entry Code

The master entry code is used to change the lock settings. A security best practice is to set your master code with 6 or more digits and create a separate code that is used daily to lock and unlock the door.

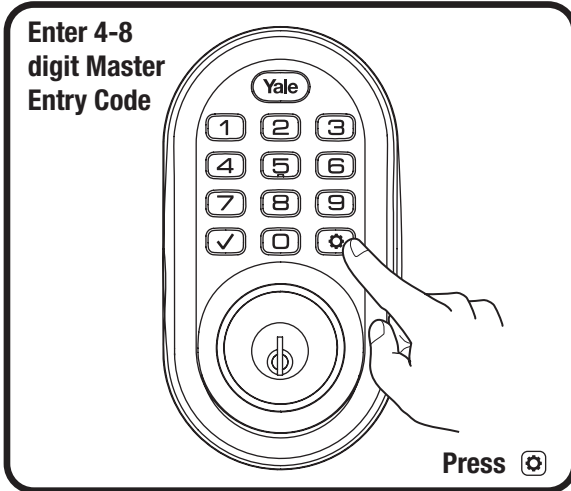

# 2

## Creating Entry Codes

Master Entry Code must be created first.

\*Max user codes = 250 with Smart Module; 25 without.

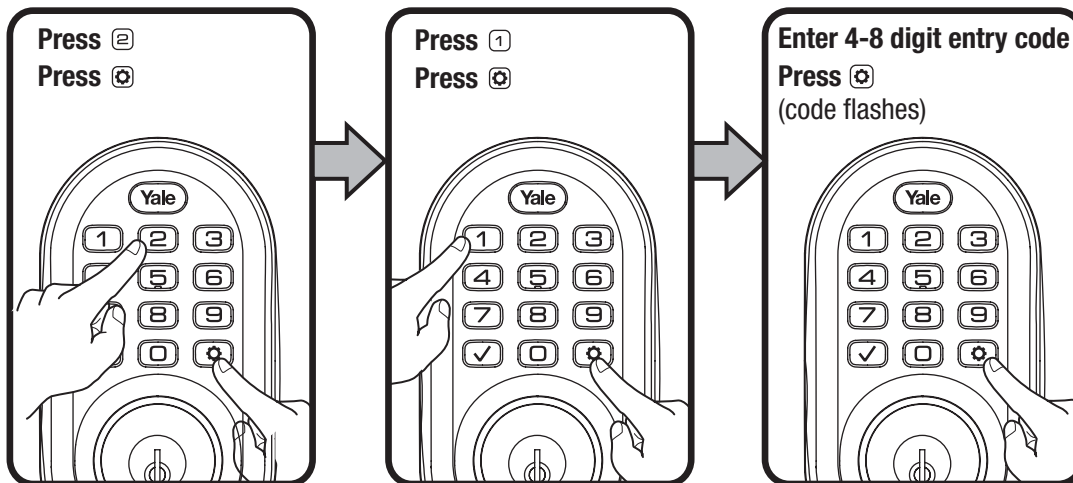
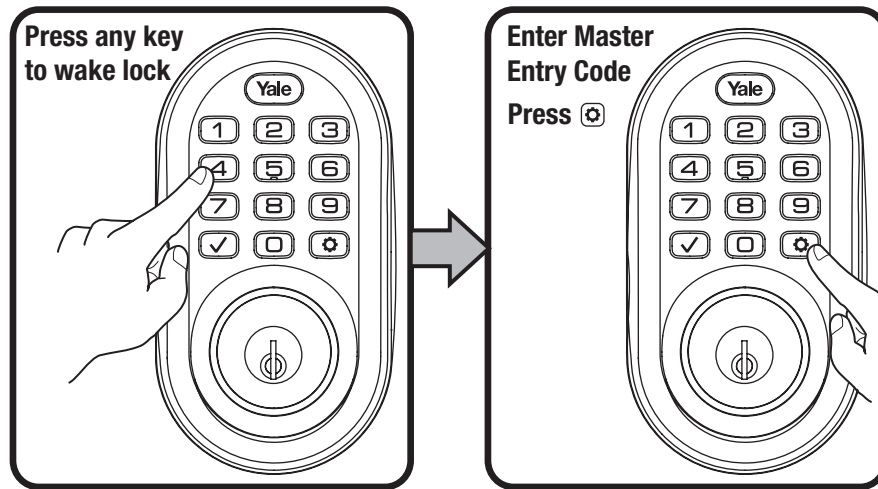

**Adding more \*User Codes:**

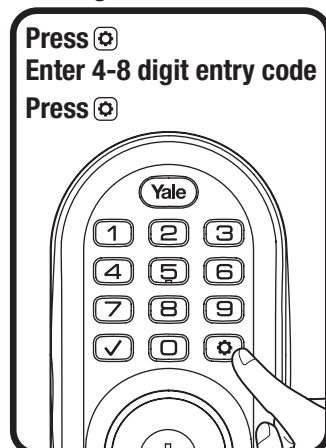

**To end programming:**



# 3

## Deleting Entry Codes

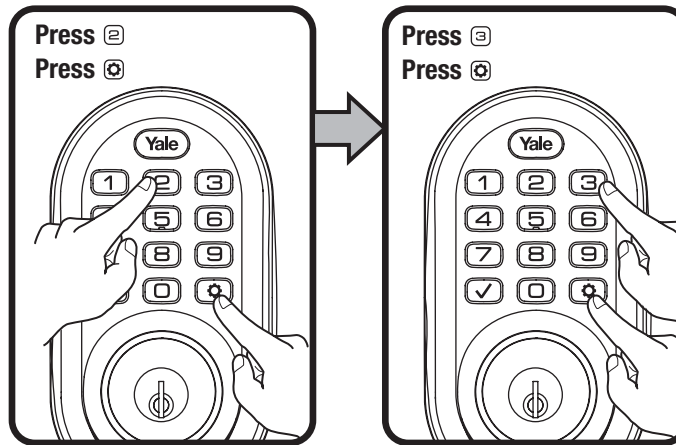
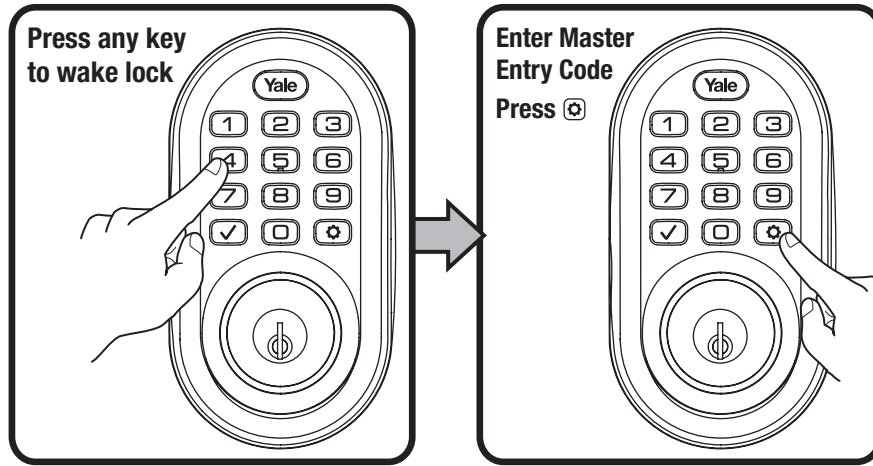

### Deleting one entry code:

To delete one entry code, you must enter the entry code you wish to delete.

### To delete all entry codes

(Does not delete Master Entry Code):

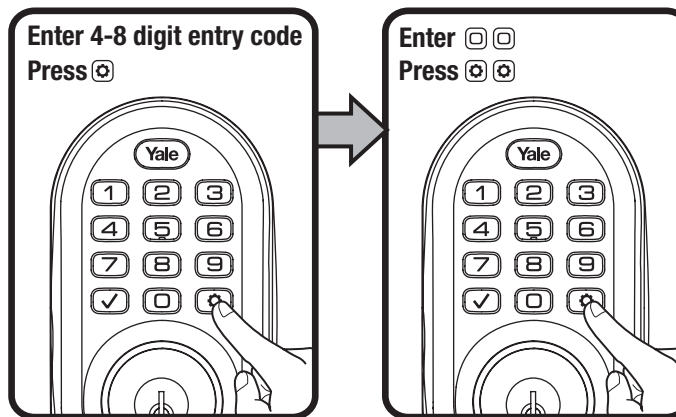



# 4

## Unlocking Door with Entry Codes

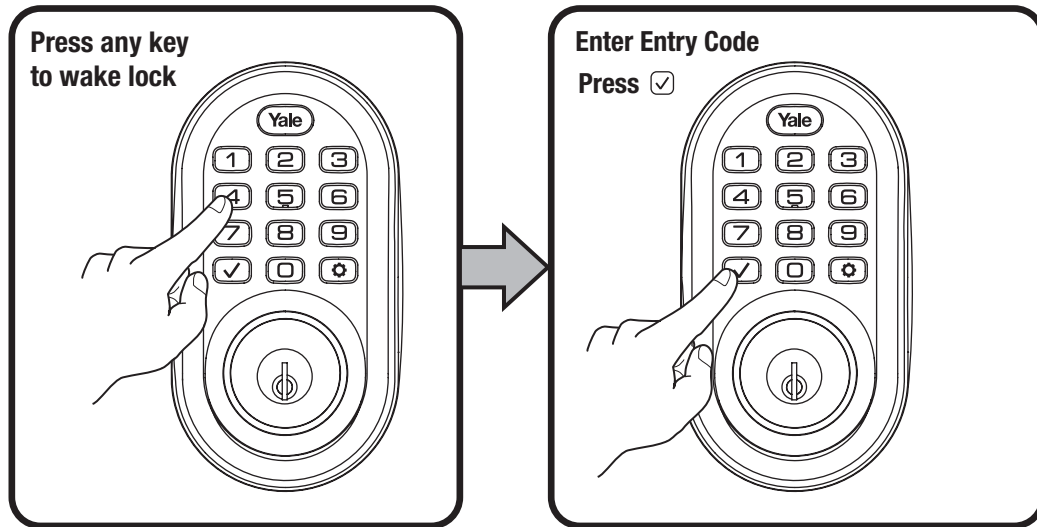

# Setting Definitions

Settings	Default Setting	Definition
Master Entry Code	Creation <b>required*</b>	The Master Entry Code is used for programming and for feature settings. <b>It must be created prior to programming the lock.</b> The Master code will also operate (unlock/lock) the lock.
All Code Lockout Mode	Disabled	This feature is enabled by the Master Entry Code. When enabled, it restricts all user (except Master) Entry Code access. When attempting to enter a code while the lock is in All Code Lockout mode, the keypad flashes 8 times and the lock beeps 3 times as well.
Audio Mode	Enabled	The audio setting for entry code verification is set to <b>enabled (1)</b> by default; otherwise it can be set to <b>disabled (3)</b> for quiet areas.
Auto Re-lock	Disabled	After a successful code entry or manual unlock with the key, the lock will automatically re-lock after each unlock in an effort to keep your home secure. This feature is optional, and can be turned off. In the ON mode, the lock will automatically re-lock after thirty (30) seconds.
Inside Indicator Light	Disabled (Off)	Located on the inside lock. Shows active status (Locked) of lock and can be enabled or disabled in the <b>Advanced Lock Settings</b> (Main Menu selection #3).
One Touch Locking	Enabled	When the latch is retracted, activating the keypad will extend the latch (during Auto Re-lock duration or when Auto Re-lock is disabled). When One-Touch Re-lock is <b>not</b> in use ( <b>disabled</b> ), any valid PIN code will re-lock the lock.
Privacy Button	Disabled	Privacy mode is disabled by default. Enable Privacy mode by pressing the privacy button for 4 seconds to put the lock in do-not-disturb mode (all pin codes are disabled).
Wrong Code Entry Limit	5 Times	After five (5) unsuccessful attempts at entering a valid entry code, the lock will shut down and not allow operation for sixty (60) seconds.
Shutdown Time	60 Seconds	The Lock will shutdown (flashing keypad) for sixty (60) seconds and not allow operation after the wrong code entry limit (5 attempts) has been met.

**\*The Master Entry Code must be created prior to any other programming of the lock.**

# Customizing Lock Through Settings Menu

## \*Master Entry Code Required



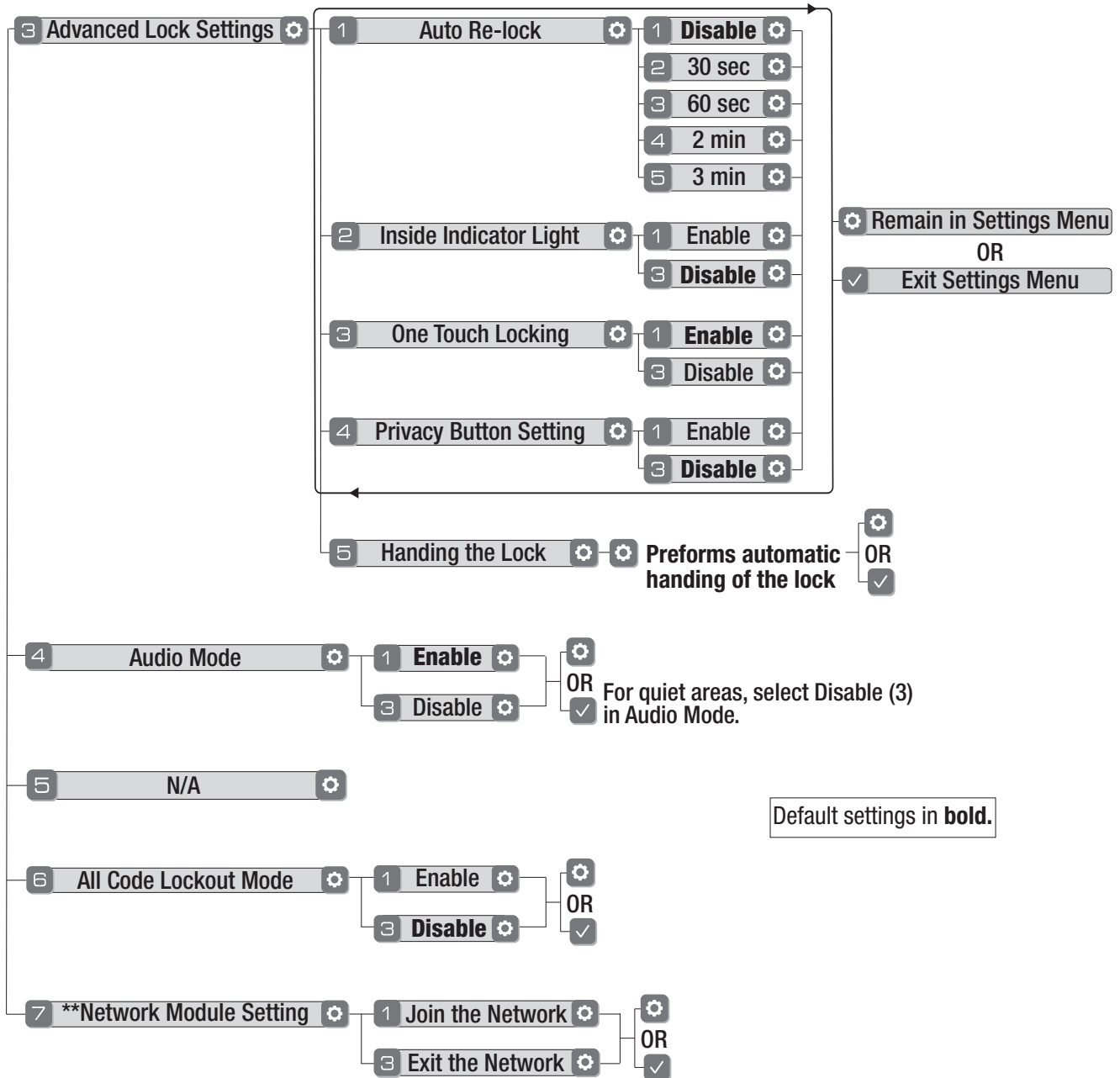



1. Press Yale logo to wake up lock .
2. Enter Master Entry Code\* followed by  icon.
3. Enter digit corresponding to the function to be performed followed by the  icon.



**Here is an example of how to set Auto Lock to 30 seconds:**  
 Master Entry Code , 3 , 1 , 2 ,

\*The Master Entry Code must be created prior to any other programming of the lock.  
 \*\*Network Module Setting function appears only with Yale Smart module installed.

# Troubleshooting

Symptom	Suggested Action
Lock does not respond – door is open and accessible.	<ul style="list-style-type: none"> <li>Yale keypad becomes active when the Yale logo is pressed. Verify contact with the logo.</li> <li>Check to see if keyed numbers respond when pressed.</li> <li>Check batteries are installed and oriented correctly (polarity) in battery case.</li> <li>Check batteries are in good condition; replace batteries* if batteries are dead.</li> <li>Check to see if keypad cable is fully connected and is not pinched.</li> </ul>
Lock does not respond – door is locked and inaccessible.	<ul style="list-style-type: none"> <li>Batteries may not have enough power. Replace batteries*.</li> <li>Use key to gain entry and replace batteries*.</li> </ul>
Lock is on for a while then shows no reaction. Lights dim.	<ul style="list-style-type: none"> <li>Batteries do not have enough power. Replace batteries*.</li> </ul>
Lock chimes to indicate code acceptance, but door will not open.	<ul style="list-style-type: none"> <li>Check the door gaps for any foreign objects between door and frame.</li> <li>Check that the cable is firmly connected to the inside lock.</li> </ul>
Lock operates to allow access, but will not automatically re-lock.	<ul style="list-style-type: none"> <li>Check to see if Auto Re-lock is enabled.</li> <li>Disable Auto Re-lock to lock the door (manually).</li> <li>If low battery indicator is lit, change batteries*.</li> </ul>
Entry codes will not register.	<ul style="list-style-type: none"> <li>Entry codes must consist of 4 to 8 digits.</li> <li>The same entry code cannot be used for multiple users.</li> <li>Management of entry codes is set by the authority of the Master Code, which is set first. Contact the Master user.</li> <li>Entry codes must be entered within 5 seconds (while keypad is active) or process will have to be restarted.</li> <li>Check  or gear  cannot be used as part of the entry code.</li> </ul>
Upon entering an entry code and pressing  key, the lock beeps and flashes red and blue 7 times and does not unlock.	<ul style="list-style-type: none"> <li>Verify entered code is a valid, previously programmed, 4 to 8 digit code.</li> <li>All Code Lockout Mode is enabled. Only the Master Entry Code can enable/disable All Code Lockout Mode. Contact the Master user.</li> </ul>
Upon entering an entry code and pressing the  key, there are different tones.	<ul style="list-style-type: none"> <li>Check to see if the lock is set to All Code Lockout Mode. Setting/managing All Code Lockout Mode is done through Master Entry Code only. Contact Master user.</li> </ul>
Lock operates, but makes no sound.	<ul style="list-style-type: none"> <li>Enable Audio Mode (see Feature #4).</li> </ul>
Lock displays intermittent RED flashes	<ul style="list-style-type: none"> <li>This is the alert to replace the batteries. Replace all four (4) batteries* with new AA Alkaline batteries.</li> </ul>
Upon entering an entry code and pressing the  key, lock beeps and flashes 3 times.	<ul style="list-style-type: none"> <li>The digits entered were incorrect or incomplete. Re-enter the correct code followed by the check  key.</li> </ul>
Deadbolt does not extend when locking the door with keypad.	<ul style="list-style-type: none"> <li>Lock was not handed properly. Rehand lock through settings menu.</li> </ul>

\* When batteries are replaced, Smart Module locks have a real time clock that will be set through the User Interface (UI); it is recommended to verify correct date and time particularly those locks operating under Daylight Saving Time (DST).

# Hardware Troubleshooting

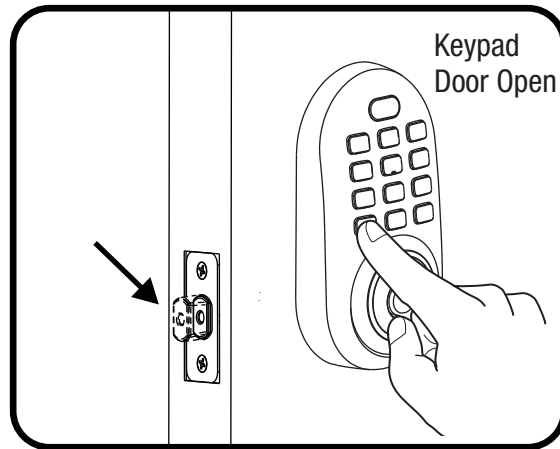
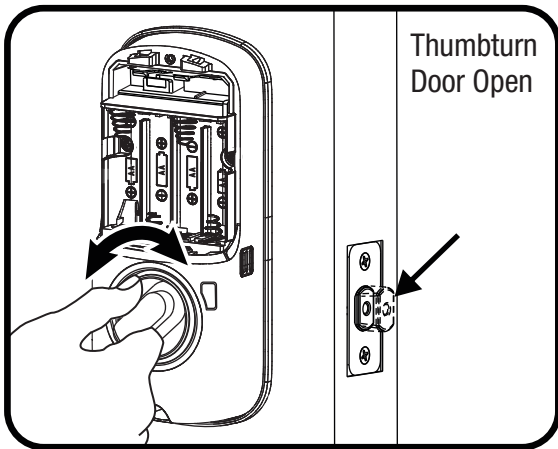

If deadbolt does not extend or retract easily when testing thumbturn and keypad operation, revisit inside and keypad installation steps. It is important that the bolt be in the retracted position during lock installations and that installation procedure is followed carefully.

## Helpful Tip:

Ensuring smooth deadbolt operation can enhance your battery life.

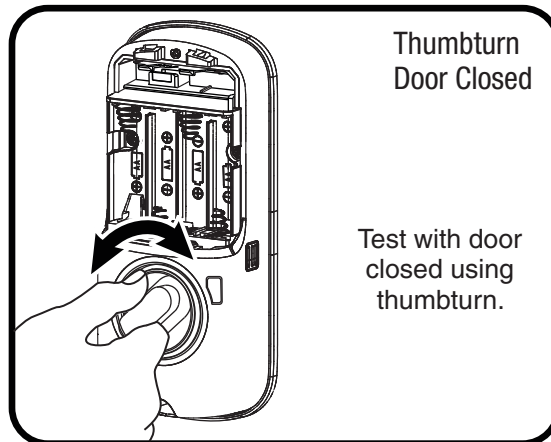

If you feel resistance, ensure deadbolt strike plate aligns with deadbolt. If deadbolt strike plate is out of alignment, please attempt to adjust knob/lever/handle set strike using steps below. The knob/lever/handle set latch engagement into the strike is the main component used for door alignment.

If deadbolt does not fully extend, consider increasing depth of deadbolt strike pocket in frame.

## To adjust Knob/Lever/Handle set strike plate:

1. Remove plate from door frame with a manual screwdriver. (Using an electric driver may strip screw heads or enlarge screw holes.)

2. Locate strike plate tab.

Bend the tab towards surface of strike. Note: a small change may be all that is required

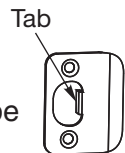

3. Reinstall strike plate using a manual screw driver and test again.

4. If door cannot be adjusted sufficiently with strike tab, both knob/lever/handle set latch and deadbolt latch could require adjustment – we suggest you contact a local locksmith for assistance.

For help with misalignments, watch our door alignment video:

<https://www.yalehome.com/en/yale/yalehome/support/yrl-electronic-lock-faqs/electronic-lock-installation/>

# Resetting Lock to Factory Default

When lock is reset to factory defaults all user codes (including the Master Entry code\*) are deleted and all programming features are reset to original default settings (see below).

1. Remove the battery cover and batteries.
2. Remove the interior side of the lock to access the reset button.
3. The reset button (see image at right) is located beside the cable adapter.
4. While pressing the reset button (minimum of 3 seconds) reinstall batteries. Release reset button.
5. Replace battery cover.

Upon reset, Master Entry Code creation is the only option available and must be performed prior to any other programming of the lock.

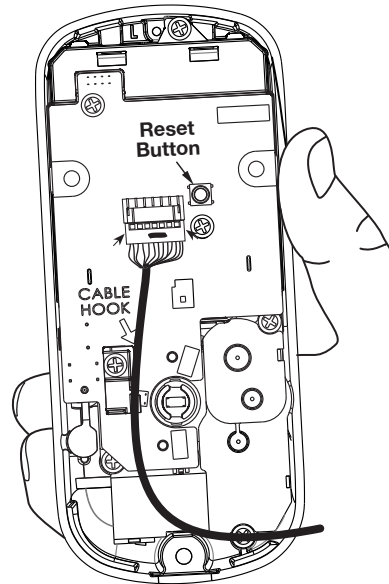

Interior Lock

# Changing Lock: Replacing Cylinder

1. To Remove cylinder:
  - A. Remove outside escutcheon from door.
  - B. Remove rubber gasket.
  - C. Remove two screws holding plastic guide in place.
  - D. Remove plastic guide.
  - E. Remove screw with washer holding cylinder in place (visible after removing plastic guide).
  - F. Remove cylinder housing by pulling cylinder tailpiece away from escutcheon.

**Before installing cylinder, be sure tailpiece is correct length (see below).**

2. To install new cylinder:
  - A. Reverse previous steps for removing cylinder.

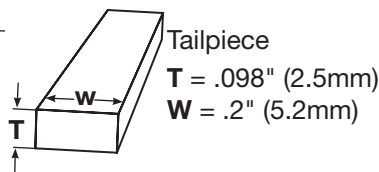
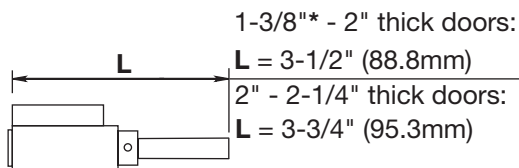
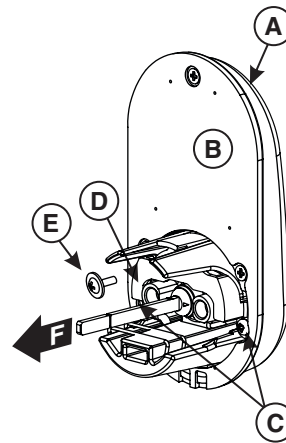

\* Requires addition of Thin Door Kit.

**FCC:***Class B Equipment*

This equipment has been tested and found to comply with the limits for a Class B digital device, pursuant to Part 15 of the FCC Rules. These limits are designed to provide reasonable protection against harmful interference in a residential installation. This equipment generates, uses, and can radiate radio frequency energy and, if not installed and used in accordance with the instructions, may cause harmful interference to radio communications. However, there is no guarantee that interference will not occur in a particular installation. If this equipment does cause harmful interference to radio or television reception, which can be determined by turning the equipment off and on, the user is encouraged to try to correct the interference by one or more of the following measures:

- Reorient or relocate the receiving antenna.
- Increase the separation between the equipment and receiver.
- Connect the equipment into an outlet on a circuit different from that to which the receiver is connected.
- Consult the dealer or an experienced radio/TV technician for help.

**Warning:** Changes or modifications to this device, not expressly approved by **ASSA ABLOY Residential Group** could void the user's authority to operate the equipment.

**Industry Canada:**

This Class A digital apparatus meets all requirements of the Canadian Interference Causing Equipment Regulations.

Cet appareillage numérique de la classe A répond à toutes les exigences de l'interférence canadienne causant des règlements d'équipement.

## Yale Locks & Hardware

Product Support Tel 1-855-213-5841 • [www.yalehome.com](http://www.yalehome.com)

Yale® and Assure Lock® are registered trademarks of ASSA ABLOY Residential Group. Other products' brand names may be trademarks or registered trademarks of their respective owners and are mentioned for reference purposes only. © Copyright 2020. All rights reserved. Reproduction in whole or in part without the express written permission of ASSA ABLOY Residential Group is prohibited.

Please use this procedure only when network primary controller is missing or otherwise inoperable.

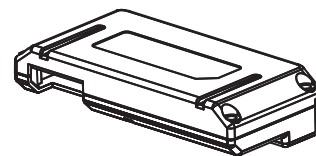

## Adding a Yale Z-Wave® Plus Smart Module to your Assure Lock & Z-Wave System

1. Install the Yale Smart Module into the slot above the battery compartment

**IMPORTANT:** The batteries must be removed before removing the Yale Smart Module:

- Remove battery cover
- Remove batteries
- Insert or remove Yale Smart Module
- Reinstall batteries
- Reinstall battery cover

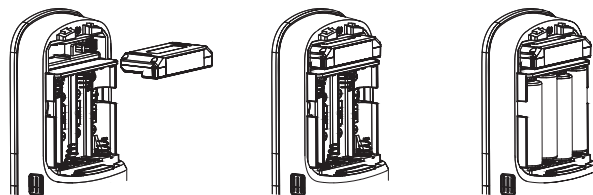

2. Open the Z-Wave system's smart home or alarm app on your smartphone or tablet

3. Follow the in-app instructions for adding a new device

4. On your lock keypad, enter your master entry code followed by the  icon

5. Press the 7 key followed by the  icon

6. Press the 1 key followed by the  icon

## Removing a Yale Z-Wave® Plus Smart Module from your Assure Lock & Z-Wave System

1. On your lock keypad, enter your master entry code followed by the  icon

2. Press the 7 key followed by the  icon

3. Press the 3 key followed by the  icon

4. Open the Z-Wave system's smart home or alarm app and follow the instructions for removing a device

5. Remove the Yale Smart Module from the slot above the battery compartment

**IMPORTANT:** The batteries must be removed before removing the Yale Smart Module:

- Remove battery cover
- Remove batteries
- Insert or remove Yale Smart Module
- Reinstall batteries
- Reinstall battery cover

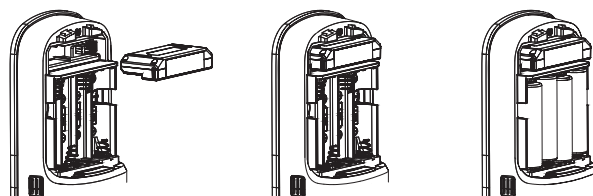

6. If you're adding a new Yale Smart Module, follow the instructions included with it





**Warning:** Changes or modifications to this device, not expressly approved by ASSA ABLOY Residential Group could void the user's authority to operate the equipment.

**This device is a security enabled Z-Wave Plus product that is able to use encrypted Z-Wave Plus messages to communicate to other security enabled Z-Wave Plus products. This device must be used in conjunction with a Security Enabled Z-Wave Controller in order to fully utilize all implemented functions. This product can be operated in any Z-Wave network with other Z-Wave certified devices from other manufacturers. All non-battery operated nodes within the network will act as repeaters regardless of vendor to increase reliability of the network.**

**FCC:**

Contain FCC ID: U4A-YRHCPZWOFM

Model: YRMZW2-US

This equipment has been tested and found to comply with the limits for a Class B digital device, pursuant to Part 15 of the FCC Rules. These limits are designed to provide reasonable protection against harmful interference in a residential installation. This equipment generates, uses, and can radiate radio frequency energy and, if not installed and used in accordance with the instructions, may cause harmful interference to radio communications. However, there is no guarantee that interference will not occur in a particular installation. If this equipment does cause harmful interference to radio or television reception, which can be determined by turning the equipment off and on, the user is encouraged to try to correct the interference by one or more of the following measures:

- Reorient or relocate the receiving antenna.
- Increase the separation between the equipment and receiver.
- Connect the equipment into an outlet on a circuit different from that to which the receiver is connected.
- Consult the dealer or an experienced radio/TV technician for help.

THIS DEVICE COMPLIES WITH PART 15 OF THE FCC RULES. OPERATION IS SUBJECT TO THE FOLLOWING TWO CONDITIONS.

(1) THIS DEVICE MAY NOT CAUSE HARMFUL INTERFERENCE, AND (2) THIS DEVICE MUST ACCEPT ANY INTERFERENCE RECEIVED, INCLUDING INTERFERENCE THAT MAY CAUSE UNDESIRE OPERATION.

Industry Canada:

Contain IC: 6982A-YRHCPZWOFM

Model: YRMZW2-US

**Section 7.1.2 of RSS-GEN** Under Industry Canada regulations, this radio transmitter may only operate using an antenna of a type and maximum (or lesser) gain approved for the transmitter by Industry Canada. To reduce potential radio interference to other users, the antenna type and its gain

should be so chosen that the equivalent isotropically radiated power (e.i.r.p.) is not more than that necessary for successful communication.

En vertu des règlements d'Industrie Canada, cet émetteur radio ne peut fonctionner avec une antenne d'un type et un maximum (ou moins) approuvés pour gagner de l'émetteur par Industrie Canada. Pour réduire le risque d'interférence aux autres utilisateurs, le type d'antenne et son gain doivent être choisies de façon que la puissance isotrope rayonnée équivalente (PIRE) ne dépasse pas ce qui est nécessaire pour une communication réussie.

**Section 7.1.3 of RSS-GEN** This Device complies with Industry Canada License-exempt RSS standard(s). Operation is subject to the following two conditions: 1) this device may not cause interference, and 2) this device must accept any interference, including interference that may cause undesired operation of the device.

Cet appareil est conforme avec Industrie Canada RSS standard exemptes de licence(s). Son fonctionnement est soumis aux deux conditions suivantes: 1) ce dispositif ne peut causer des interférences, et 2) cet appareil doit accepter toute interférence, y compris les interférences qui peuvent causer un mauvais fonctionnement du dispositif.

This radio transmitter 6982A-YRHCPZWOFM has been approved by Industry Canada to operate with the antenna types listed below with the maximum permissible gain indicated. Antenna types not included in this list, having a gain greater than the maximum gain indicated for that type, are strictly prohibited for use with this device.

Le présent émetteur radio 6982A-YRHCPZWOFM a été approuvé par Industrie Canada pour fonctionner avec les types d'antenne énumérés ci-dessous et ayant un gain admissible maximal. Les types d'antenne non inclus dans cette liste, et dont le gain est supérieur au gain maximal indiqué, sont strictement interdits pour l'exploitation de l'émetteur.

CAN ICES-3B/NMB-3B

## Yale Locks & Hardware

24/7 Tech Support : 1-855-492-0505 • [www.yalehome.com](http://www.yalehome.com)

Yale® is a registered trademark of ASSA ABLOY Residential Group. Other products' brand names may be trademarks or registered trademarks of their respective owners and are mentioned for reference purposes only. © Copyright 2019. All rights reserved. Reproduction in whole or in part without the express written permission of ASSA ABLOY Residential Group is prohibited.

## Installing the ZigBee® Module

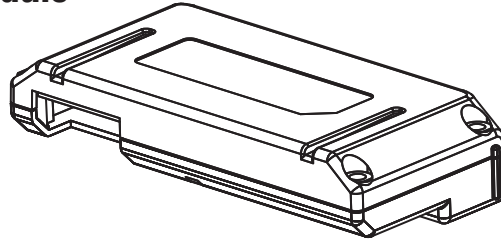

**IMPORTANT:** the batteries must be removed prior to removing and/or inserting the network module:



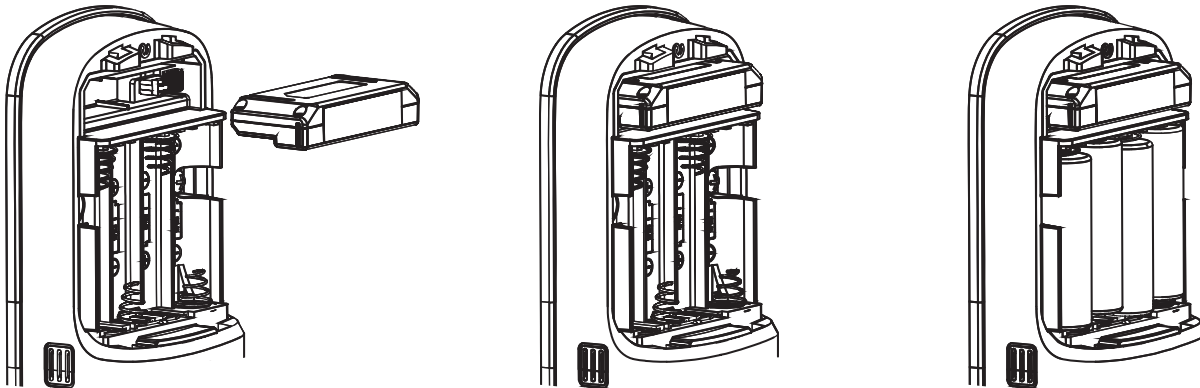

- Remove battery cover.
- Remove batteries.
- Remove and/or insert network module.
- Reinstall batteries.
- Replace cover.







## Enrolling/Unenrolling the Network Module:

This device is a security enabled ZigBee product that is able to use encrypted ZigBee messages to communicate to other security enabled ZigBee products. This device must be used in conjunction with a Security Enabled ZigBee Controller in order to fully utilize all implemented functions. This product can be operated in any ZigBee network with other ZigBee certified devices from other manufacturers. All non-battery operated nodes within the network will act as repeaters regardless of vendor to increase reliability of the network.

To Enroll the Module (Inclusion Mode):

- Enter the 4-8 digit Master PIN code followed by the  key.
- Press the  key followed by the  key.
- Press the  key followed by the  key.

To Unenroll the Module (Exclusion Mode):

- Enter the 4-8 digit Master PIN code followed by the  key.
- Press the  key followed by the  key.
- Press the  key followed by the  key.

**FCC:**

FCC ID: U4A-YRHCPZB0FM

Model: YRMZB2

This equipment has been tested and found to comply with the limits for a Class B digital device, pursuant to Part 15 of the FCC Rules. These limits are designed to provide reasonable protection against harmful interference in a residential installation. This equipment generates, uses, and can radiate radio frequency energy and, if not installed and used in accordance with the instructions, may cause harmful interference to radio communications. However, there is no guarantee that interference will not occur in a particular installation. If this equipment does cause harmful interference to radio or television reception, which can be determined by turning the equipment off and on, the user is encouraged to try to correct the interference by one or more of the following measures:

- Reorient or relocate the receiving antenna.
- Increase the separation between the equipment and receiver.
- Connect the equipment into an outlet on a circuit different from that to which the receiver is connected.
- Consult the dealer or an experienced radio/TV technician for help.

This equipment complies with FCC radiation exposure limits set forth for an uncontrolled environment. This equipment should be installed and operated with minimum distance 20cm between the radiator and your body. This transmitter must not be co-located or operating in conjunction with any other antenna or transmitter.

This device complies with Part 15 of the FCC rules. Operation is subject to the following two conditions: (1) This device may not cause harmful interference, and (2) this device must accept any interference received, including interference that may cause undesired operation. Any changes or modifications not expressly approved by manufacturer could void the user's authority to operate the equipment.

**IMPORTANT!** Any changes or modifications not expressly approved by the party responsible for compliance could void the user's authority to operate this equipment.

Industry Canada:

IC: 6982A-YRHCPZB0FM

Model: YRMZB2

This Device complies with Industry Canada License-exempt RSS standard(s). Operation is subject to the following two conditions: 1) this device may not cause interference, and 2) this device must accept any interference, including interference that may cause undesired operation of the device.

Le présent appareil est conforme aux CNR d'Industrie Canada applicables aux appareils radio exempts de licence. L'exploitation est autorisée aux deux conditions suivantes: (1) l'appareil ne doit pas produire de brouillage, et (2) l'utilisateur de l'appareil doit accepter tout brouillage radioélectrique subi, même si le brouillage est susceptible d'en compromettre le fonctionnement.

**Important Note:****Radiation Exposure Statement:**

This equipment complies with IC radiation exposure limits set forth for an uncontrolled environment. This equipment should be installed and operated with minimum distance 20cm between the radiator and your body.

**Note Importante: (Pour l'utilisation de dispositifs mobiles)****Declaration d'exposition aux radiations:**

Cet équipement est conforme aux limites d'exposition aux rayonnements IC établies pour un environnement non contrôlé. Cet équipement doit être installé et utilisé avec un minimum de 20 cm de distance entre la source de rayonnement et votre corps.

**IMPORTANT!** Any changes or modifications not expressly approved by the party responsible for compliance could void the user's authority to operate this equipment.

**IMPORTANT!** Tous les changements ou modifications pas expressément approuvés par la partie responsable de la conformité ont pu vider l'autorité de l'utilisateur pour actionner cet équipement.

CAN ICES-3B/NMB-3B

## Yale Locks & Hardware

Product Support Tel 1-855-213-5841 • [www.yalehome.com](http://www.yalehome.com)

Yale Locks &amp; Hardware is a division of Yale Security Inc., an ASSA ABLOY Group company.

Yale® and Yale Real Living® are registered trademarks of Yale Security Inc., an ASSA ABLOY Group Company.Other products' brand names may be trademarks or registered trademarks of their respective owners and are mentioned for reference purposes only.Copyright © 2017, Yale Security Inc., an ASSA ABLOY Group company.All rights reserved. Reproduction in whole or in part without the express written permission of Yale Security Inc. is prohibited.

**YALE**, with its unique global reach and range of products, is the world's favorite lock  
– the preferred solution for securing your home, family and personal belongings.

**ASSA ABLOY** is the global leader in door opening solutions,  
dedicated to satisfying end-user needs for security, safety and convenience.