

Series SPB Audio Boosters

Installation, Testing, Operation, and Maintenance Manual

Part Number P84748

Revision G

Copyright 2015 Cooper Wheelock Inc., dba Cooper Notification. All rights reserved.

About Cooper Wheelock, Inc.:

Cooper Wheelock, Inc. fulfills its mission of Helping People Take Action by providing high quality and advanced products and services for the life safety, communications, and security markets. Cooper Wheelock has served the needs of commercial, educational, industrial, health care, and government users for more than eighty-five years.

Today the company continues to focus on designing and manufacturing advanced technological products to meet the world's needs for Emergency Incident Management and Notification, Multi-Function Communications, and Mass Notification.

For more information, contact:

Cooper Wheelock, Inc.
273 Branchport Avenue
Long Branch, NJ 07740-6899
Telephone: (800) 631.2148
Fax: (732) 222.2588
Web Site: www.coopernotification.com
E-Mail: SupportMVSR-Mail@Eaton.com

Table of Contents

Chapter: 1 Foreword	1
1.1 Intended Use	1
1.2 Design Change Disclaimer	1
1.3 User Operation Assistance	1
1.4 Typographical Notation Conventions	1
Chapter: 2 Safety Precautions	3
2.1 Read This Manual	3
2.2 Operational Safety	3
2.2.1 Expected Equipment Lifecycle	4
2.2.2 Periodic Testing	4
2.3 Compliance with Applicable Codes, Regulations, Laws, Standards, and Guidelines	5
2.4 Property Insurance Recommendation	5
2.5 Audio Output Considerations	5
2.6 RF Interference	6
2.7 General	6
Chapter: 3 Overview	7
3.1 Compatibility with Existing Safepath4 Products	7
3.2 Standard Features	7
Chapter: 4 Installation	13
4.1 Introduction	13
4.2 General Installation Instructions	14
4.2.1 Unpacking and Taking Inventory (new from outline)	14
4.2.2 Mounting the Audio Booster	18
4.2.3 Installing Field Wiring Connections	18
4.2.4 Installing Audio and Auxiliary Input Connections	20
4.2.5 Installing Strobe Input Connections (SPB-80/4)	21
4.2.6 Installing Audio and Strobe Output Circuit Connections	21
4.2.7 Installing Expansion Output and Trouble Contact Connections	23
4.2.8 Installing Power and Battery Connections	24
4.3 Two-Wire Audio and Four-Wire Audio Modes	26
4.3.1 Two-Wire Audio Mode with AC Loss Reported on Main Trouble Contacts	27
4.3.2 Four-Wire Audio Mode with AC Loss Trouble Reported on Main Trouble Contacts	28
4.3.3 Two-Wire Mode with AC Loss Reported on AC TRB Contacts	29
4.3.4 Four-Wire Audio Mode with AC Loss Trouble Reporting on AC TRB Contacts	30
4.4 Wiring the Panel	31
4.4.1 Wiring Guidelines	31
4.4.2 Field Wiring Connections	31
4.4.3 Visual Notification Appliance Output Wiring (SPB-80/4 only)	31

4.4.4	Speaker Notification Appliance Output Wiring.....	32
4.4.5	Trouble Output Contact Wiring	33
4.4.6	Power Connection Requirements	33
4.5	Mounting the Panel	36
4.5.1	Locating the Panel	36
4.6	Performing System Checkout	39
4.6.1	System Control Settings	39
4.6.2	Checkout Procedure	42
4.7	Ground Fault Detection.....	42
4.8	Battery Care and Backup Battery Calculations	43
4.8.1	Caring for Sealed Lead Acid Batteries.....	43
4.8.2	Storing Batteries	43
4.8.3	Calculating Backup Battery Requirements	44
4.9	Installing AC Power and Batteries.....	45
4.9.1	Installing AC Power	45
4.9.2	Installing Batteries.....	45
Chapter: 5	Operation	51
5.1.1	Audio Notification Appliance Output Circuit Supervision.....	52
5.1.2	Visual Notification Appliance Output Circuit Supervision (SPB-80/4 only)	52
5.1.3	Amplifier Supervision	52
5.1.4	Ground Fault Supervision	52
5.2	Actions that Initiate Alarms	52
Chapter: 6	Operational Procedures	53
Chapter: 7	Periodic Testing and Maintenance	55
7.1	Introduction.....	55
7.2	Periodic Testing	55
7.2.1	Test Frequency	55
7.2.2	Equipment	55
7.3	Faulty Equipment.....	55
7.4	Qualified Personnel.....	56
Chapter: 8	Troubleshooting	57
8.1	Introduction.....	57
8.2	Troubleshooting	57
8.2.1	Procedure A.....	61
8.2.2	Procedure B.....	61
8.2.3	Procedure C	62
8.2.4	Procedure D.....	62
8.2.5	Procedure E	62
8.2.6	Procedure F	63
8.2.7	Procedure G.....	63
8.2.8	Procedure H.....	63
8.2.9	Procedure I	64
8.2.10	Procedure J	64
8.2.11	Procedure K (SPB-160 Only).....	64

8.2.12	Procedure L (SPB-160 Only)	65
8.2.13	Procedure M (SPB-80/4 Only)	65
8.2.14	Procedure N (SPB-80/4 Only)	65
8.2.15	Procedure O (SPB-80/4 Only)	66
8.2.16	Procedure P (SPB-80/4 Only)	66
Chapter: 9	Technical Data	69
9.1	Mechanical	69
9.2	Environmental	69
9.3	Electrical	70
9.3.1	Input	70
9.3.2	Battery Current Calculations	70
9.3.3	Activation Inputs	70
9.3.4	Outputs	70
9.4	Wiring Connections	71
9.4.1	End of Line Resistor (1/2W EOLR).....	71
Chapter: 10	Warranty	73
10.1	Limited Warranty	73
10.2	Limitation of Liability	74
Chapter: 11	Battery Calculation Worksheet	75
Chapter: APPENDIX A	77

This page is left blank intentionally.

List of Figures

Figure 1 SPB-80/4 Audio Booster Panel, Basic Capabilities	9
Figure 2 SPB-160 Audio Booster Panel, Basic Capabilities	9
Figure 3 SPB-320 Audio Booster Panel, Basic Capabilities	10
Figure 4 SPB-80/4 Audio Booster Panel	10
Figure 5 SPB-160 Audio Booster Panel	11
Figure 6 SPB-320 Audio Booster Panel	11
Figure 7 Location of Field Wiring Connections SPB-80/4	15
Figure 8 Location of Field Wiring Connections SPB-160/SPB-320	16
Figure 9 Removable Terminal Block	18
Figure 10 Power Limited and Non-Power Limited Wiring	19
Figure 11 Audio and Auxiliary Input Connections	20
Figure 12 Strobe Input Connections (SPB-80/4)	21
Figure 13 Audio and Strobe Output Connections (SPB-80/4)	22
Figure 14 Audio Output (SPB-160 and SPB-320) Connections	22
Figure 15 Alarm and Trouble Connections	23
Figure 16 Power and Battery Connections	24
Figure 17 Two-Wire Audio Mode with AC Loss Reported on Main Trouble Contacts	27
Figure 18 Four-Wire Audio Mode with AC Loss Reported on Main Trouble Contacts	28
Figure 19 Two-Wire Audio Mode with AC Loss Reported on AC TRB Contacts	29
Figure 20 Four-Wire Audio Mode with AC Loss Trouble Reporting on AC TRB Contacts	30
Figure 21 Wiring Diagram for Visual Only Notification Appliances (SPB-80/4 Only)	32
Figure 22 Wiring Diagram for Combination Audio/ Visual Notification Appliances (SPB-80/4 Only)	32
Figure 23 Wiring Diagram for Audio Only Notification Appliance Output	33
Figure 24 Trouble Status Relay Contacts	33
Figure 25 Input Power Connection Location, SPB Power Supply	34
Figure 26 Input Power Connection Location on the SPB Power Supply (SPB-320 only)	35
Figure 27 DC and Battery Connection on the Audio Booster Motherboard	36
Figure 28 SPB-80/4 and SPB-160 Audio Booster Panel Mounting and Grounding Location	37
Figure 29 SPB-320 Audio Booster Panel	38
Figure 30 Jumper/Switch Locations on SPB-80/4	39
Figure 31 Jumper/Switch Locations on SPB-160 and SPB-320	40
Figure 32 Battery Configuration and Wiring (SPB-320 only)	46
Figure 33 Proper Wiring for SPB-320 with and without SPLITTERS	47
Figure 34 SPB-80/4 LED Locations	59
Figure 35 SPB-160 and SPB-320 LED Locations	60

This page is left blank intentionally.

List of Tables

Table 1 Terminal Blocks Connection Definitions.....	17
Table 2 Series SPB Wiring Modes.....	26
Table 3 Jumper/Switch/Variable Resistor Functions	41
Table 4 Trouble LED Procedure Cross Reference	58

This page is left blank intentionally.

1 Foreword

1.1 Intended Use

This manual is designed to serve the installers and operators of the SPB-80/4 Audio Booster (P/N 118988), the SPB-80/4-B Audio Booster (P/N 119931), the SPB-160 Audio Booster (P/N 118989), the SPB-160/B Audio Booster (P/N 119930), and the SPB-320 Audio Booster (P/N 119918) system. All operating instructions, product illustrations, troubleshooting/error messages, and other relevant information are contained in this manual. It is the user's responsibility to ensure that all instructions in this manual are applied strictly.

1.2 Design Change Disclaimer

Due to design changes and product improvements, information in this manual is subject to change without notice. Cooper Wheelock reserves the right to change product design, including illustrations and diagrams, at any time without notice to anyone, which may subsequently affect the contents of this manual.

Cooper Wheelock assumes no responsibility for any errors that may appear in this manual. Cooper Wheelock will make every reasonable effort to ensure that this manual is up to date and corresponds with the shipped Cooper Wheelock Series SPB Audio Booster.

1.3 User Operation Assistance

Should you experience any difficulty in installing or operating your Series SPB Audio Booster product, please contact your Cooper Wheelock representative. The Troubleshooting chapter in this manual (Chapter 8) includes a list of common system problems, possible causes, and corrective operator actions. The information given here is general. Feel free to contact the Technical Support department of Cooper Wheelock at 1-800-631-2148. Hours are 8:00 a.m. - 7:00 p.m. (Eastern Standard Time), Monday through Thursday and 8:00 a.m. - 5:00 p.m. (Eastern Standard Time) on Friday.

1.4 Typographical Notation Conventions

Thank you for using our products. Use this product according to this instruction manual. Please keep this instruction manual for future reference.

Any material extrapolated from this document or from Cooper Wheelock manuals or other documents describing the product for use in promotional or advertising claims, or for any other use, including description of the product's application, operation, installation and

Foreword

testing is used at the sole risk of the user and Cooper Wheelock will not have any liability for such use.

Certain information contained in this manual has been extracted from the NFPA 72 Manual and the Life Safety Code 101™ Manual.

WARNINGS

 **WARNING:** A Warning indicates a potentially hazardous situation that, if not avoided, could result in serious personal injury or death to you or others. Warnings are set off in boldface type, within boxed rules, indented, and referenced to a warning symbol.

CAUTIONS



CAUTIONS: indicate a situation in which the equipment could be damaged or a situation in which not following the instructions correctly could result in the equipment not working properly. Cautions are set off with a stop sign symbol.

2 Safety Precautions

2.1 Read This Manual

1. Cooper Wheelock recommends that, before performing any actions to specify, apply, install, maintain, and operationally test Series SPB Audio Boosters, personnel properly qualified in the application and use of life safety equipment read this manual carefully.
2. Keep this manual with the Series SPB Audio Booster panel for reference during the life of the system. Make this manual available to all qualified personnel who operate, test, maintain, or service Series SPB Audio Booster products. It is strongly recommend that such personnel read and understand the entire manual.

2.2 Operational Safety

 **WARNING:** If safety precautions, installation, and testing instructions are not performed properly, the Series SPB Audio Boosters may not operate in an emergency situation, which could result in serious injury or death to you and/or others.

 **WARNING:** If the protective signaling system sounds and/or flashes, it is a warning that a possible serious situation requires immediate attention.

-  **CAUTION:** Series SPB Audio Booster printed circuit boards are sensitive to static electricity and have delicate components mounted on it.
- (a) Discharge any static electricity from your body by touching a grounded object, such as a metal screw, which is connected to earth ground.
 - (b) Handle the board by its edges and be careful not to twist or flex it. Install the Series SPB Audio Booster panel in a static-free area.
 - (c) Attach grounded wrist straps properly before touching any static sensitive areas.
 - (d) After handling Series SPB Audio Booster printed circuit board, test the panel as described in section 4.6 to verify that it is functioning properly.

NOTE: In areas prone to lighting strikes, using a surge protection device is recommended.

NOTE: This SPB Series Audio Booster panel **will not work** without power. The SPB Series Audio Booster panel is powered by 120VAC. 24VDC re-chargeable batteries provide backup power. If both sources of power are cut off for any reason, the SPB Series Audio Booster panel **will not operate**.

1. DO NOT assume any installation, operation and testing details not shown in this manual.

2.2.1 Expected Equipment Lifecycle

Notification equipment cannot last forever. Even though the Series SPB Audio Booster is expected to last up to ten years, any of its parts or components could fail before then.

2.2.2 Periodic Testing

1. Cooper Wheelock recommends testing of the entire protective signaling system, including the Series SPB Audio Booster panel, all notification equipment, as well as all messages and their output channel, and priority assignment, at least twice each year, or more often as required by local, state and federal codes, regulations and laws, by qualified personnel.
2. **If the notification equipment is not working properly, immediately contact the installer and have all/any problems corrected immediately.**
3. **Replace any malfunctioning components immediately; do not attempt to repair malfunctioning components.** Return malfunctioning components for factory repair or replacement. In the event you cannot contact the installer, contact the manufacturer.

 **WARNING:** For proper operation in life safety applications, perform the following: (a) Connect the Series SPB Audio Booster panel to a listed compatible and properly operating voice evacuation panel such as the Cooper Wheelock, Inc. SP40S (OR SPMNS) panel, which controls its activation. (b) Ensure that all equipment is properly interconnected and operating. (c) Make sure the installer checks the compatibility of all equipment prior to installation; otherwise, the Series SPB Audio Booster panel and/or the voice evacuation panel may be damaged and/or fail to operate in an emergency situation.

 **WARNING:** Certain hardware functions on the Series SPB Audio Booster panel are not supervised. If any such hardware functions fail, the Series SPB Audio Booster panel may not provide the intended warning and/or not indicate a trouble condition.

2.3 Compliance with Applicable Codes, Regulations, Laws, Standards, and Guidelines

Comply with all of the latest applicable codes, regulations, laws, standards, and guidelines.

- ⚠ WARNING: Ensure that for emergency, life safety applications using the Series SPB Audio Booster, installation, testing and maintenance is always performed by qualified personnel in accordance with all the latest National Fire Protection Association (NFPA), Underwriter’s Laboratory (UL), National Electric Code (NEC), Occupational Safety and Health Administration (OSHA), state, county, local, province, district, federal, and other applicable building and fire standards, guidelines, regulations, laws, and codes including, but not limited to, all appendices and amendments and requirements of the Local Authority Having Jurisdiction (AHJ).**
- ⚠ WARNING: All Electrical installations shall be in accordance with the appropriate national electrical code – CAN/ULC S524, Canadian Electrical Code, Part 1, National Building Code of Canada. Final acceptance is subject to Authorities Having Jurisdiction.**

It is recommended that the local Authority Having Jurisdiction (AHJ) inspect and approve the proposed placement of all the notification appliances.

2.4 Property Insurance Recommendation

The Voice Evacuation System containing the SPB Series Audio Booster panel is not a substitute for insurance. Make sure that you have adequate levels of life and property insurance.

2.5 Audio Output Considerations

- ⚠ WARNING: Audible signals may mask medical equipment monitoring alarms. Where medical equipment monitoring alarms are in use, do not use audible signals; provide visual notification appliances in highly visible locations.**



CAUTION: The output of the audio system may not be heard in all cases. Sound can be blocked or reduced by walls, doors, carpeting, wall coverings, furniture, insulation, bed coverings, and other obstacles that may temporarily or permanently impede the output of the audio system. Sound is also reduced by distance and masked by background noise.

The output of the audio system may not be sufficient to alert all occupants, especially those who are asleep, those who are hearing-impaired, those who are wearing devices that plug or cover the ears, and those who have recently used drugs or alcohol.

The output of the audio system may not be heard by an alert person if the output device is placed in an area which is isolated by a closed door, or is located on a different floor from the person in a hazardous situation or is placed too far away to be heard over ambient noise such as, but not limited to, running water, traffic, air conditioners, machinery or musical appliances.

If live microphone announcements, audible tones and/or voice messages cannot be readily heard and understood clearly within the protected areas as intended, increase the number and/or sound output intensity of speakers within those areas so that they are heard and understood clearly when activated.

2.6 RF Interference

The Series SPB Audio Booster panel has been tested and found to comply with the limits for a Class A digital device, pursuant to Part 15 of the FCC Rules. These limits are designed to provide reasonable protection against harmful interference when the equipment is operated in a commercial environment. This equipment generates, uses, and can radiate radio frequency energy and, if not installed and used in accordance with the instruction manual, may cause harmful interference to radio communications. Operation of this equipment in a residential area is likely to cause harmful interference in which case the user is required to correct the interference at his/her own expense.

2.7 General

Each manufacturer's fire alarm control panel and notification appliances operate differently and have different features. Before specifying, installing, operating, testing, maintaining, or servicing a system, carefully read the installation, operation, and testing manual for each piece of equipment and applicable codes.

Additional copies of this manual may be obtained from:

Cooper Wheelock, Inc.
273 Branchport Ave.
Long Branch, N.J. 07740
Tel: (800) 631-2148
Fax: (732) 222- 2588
E-mail: SupportMVSR-Mail@Eaton.com

3 Overview

The Series SPB Audio Boosters provide added power for speakers and strobes when the existing power supply's capacity is not sufficient.

The SPB-80/4 has one 80-watt audio output and two 2-amp strobe outputs for a total of 4 amps of strobe power at 27 volts of DC power.

The SPB-160 has two 80-watt audio outputs for a total of 160 watts. The SPB-160 does not provide strobe power.

The SPB-320 has four 80-watt audio outputs for a total of 320 watts. The SPB-320 also does not supply strobe power.

There is an additional 0.5 amps of auxiliary power at 27VDC that can be used to power other SafePath products. The Series SPB Audio Boosters operate from a primary power source of 120VAC and can accommodate up to a 33AH back-up battery. Up to 12Ah batteries will fit in the enclosure.

3.1 Compatibility with Existing Safepath4 Products

The Series SPB Audio Boosters are fully compatible with the SP40S (OR SPMNS), all current Audio Splitters (SP4Z-A/B and SP4-APS), the SafePath Remote Microphone (SPRM), the SafePath Volume Control (SP-SVC), the Telephone Zone Controller (SP4-TZC), and the SafePath Remote Microphone Expander (SP4-RMX).

3.2 Standard Features

Feature	SPB-80/4	SPB-160	SPB-320
Strobe Input Circuit	Power limited 8-33VDC NAC or CC strobe Activation	No Strobe Circuits.	No Strobe Circuits.
Strobe Output Circuit	<ul style="list-style-type: none">• Two - 27VDC, 2A Max regulated NAC Supervised power limited strobe outputs.• Selectable Outputs: System Wide Wheelock Sync, Pass Through, or Constant DC.• Trouble LED's for open and short output conditions.• Supervised with 10K Ohm 1/2W EOLR.	No Strobe Circuits.	No Strobe Circuits.

Audio Input Circuit	One 1.2 Watt 1V, 25V (Class 2) or 70.7V (Class 3) input.	One 1.2 Watt 1V, 25V (Class 2) or 70.7V (Class 3) input.	Two 1.2 Watt 1V, 25V (Class 2) or 70.7V (Class 3) input.
Audio Output Circuit	<ul style="list-style-type: none"> • One 80-Watt, 25V (Class 2) or 70.7V (Class 3) selectable, supervised, power limited audio output. • Trouble LEDs for open and short output conditions. • Supervised with 10K Ohm 1/2W EOLR. 	<ul style="list-style-type: none"> • Two 80-Watt, 25V (Class 2) or 70.7V (Class 3) selectable, supervised, power limited audio output. • Trouble LEDs for open and short output conditions. • Supervised with 10K Ohm 1/2W EOLR. 	<ul style="list-style-type: none"> • Four 80-Watt, 25V (Class 2) or 70.7V (Class 3) selectable, supervised, power limited audio output. • Trouble LEDs for open and short output conditions. • Supervised with 10K Ohm 1/2W EOLR.
Battery Standby Sleep Mode	<ul style="list-style-type: none"> • When Audio Booster loses AC power, the amplifier section shuts down in order to conserve battery power. <ul style="list-style-type: none"> • The Four-Wire Mode allows non-alarm functions on the SP40S (OR SPMNS). When an alarm signal sends a message to the Audio Booster, the amplifier re-energizes and broadcasts the message. • The Two-Wire Mode also shuts off non-alarm functions (BGM, TEL, etc.) on the SP40S (OR SPMNS). When a NAC/CC is sent to the AUX IN the Audio Booster will wake for broadcast. 		
Power Supply Selection	<ul style="list-style-type: none"> • 120VAC, 3.8A, 50-60Hz input • 27VDC, Up to 33Ah Battery Backup • 27VDC, 0.5A Power Output for Splitter Connections 	<ul style="list-style-type: none"> • Two separate 27VDC Power Supplies • 27VDC, Up to 33Ah Battery Backup 	
Supervision	<p>Full supervision with on-board diagnostics and trouble reporting circuits for:</p> <ul style="list-style-type: none"> Audio NAC circuit wiring — open and short conditions Ground Fault detection Strobe NAC circuit wiring — open and short conditions Amplifier — operation Input voltage/low battery 		
Trouble Reporting	Form C relay trouble contacts for external notification.		

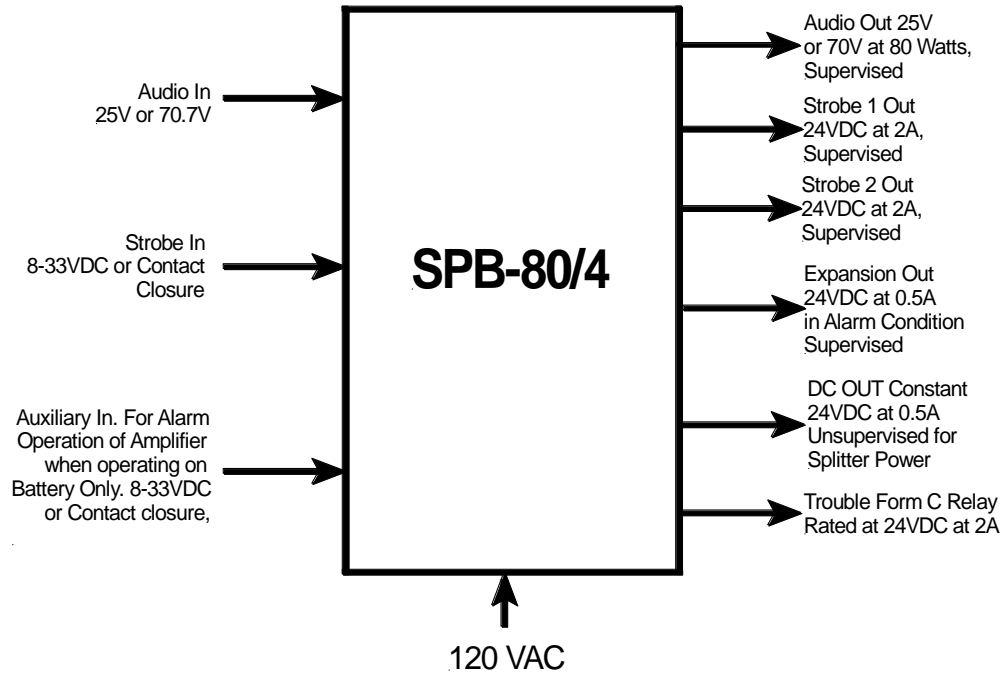
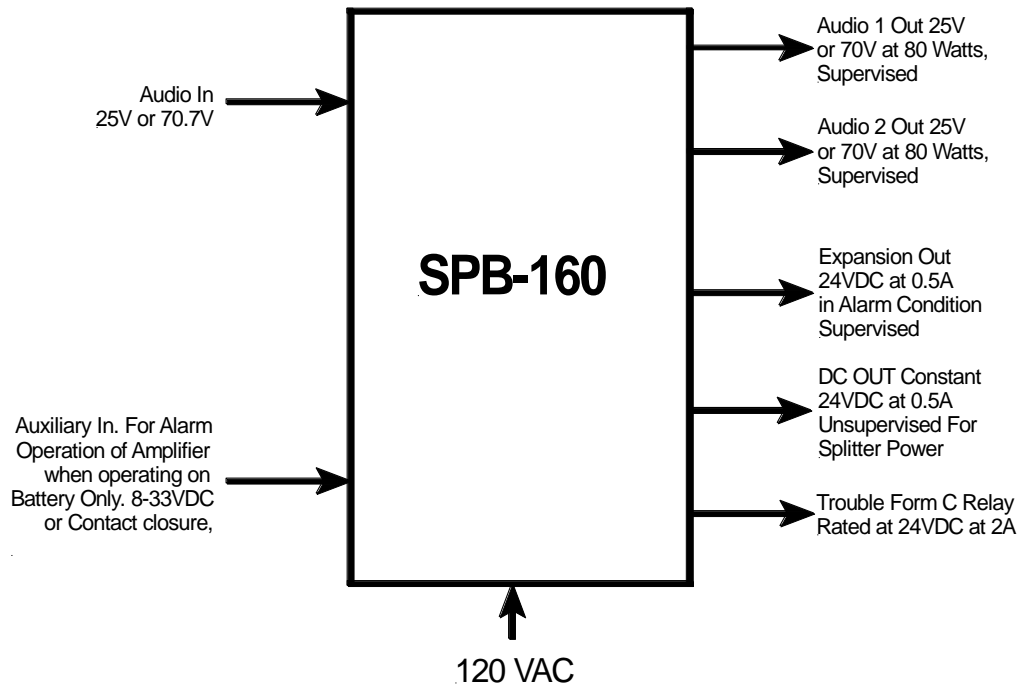
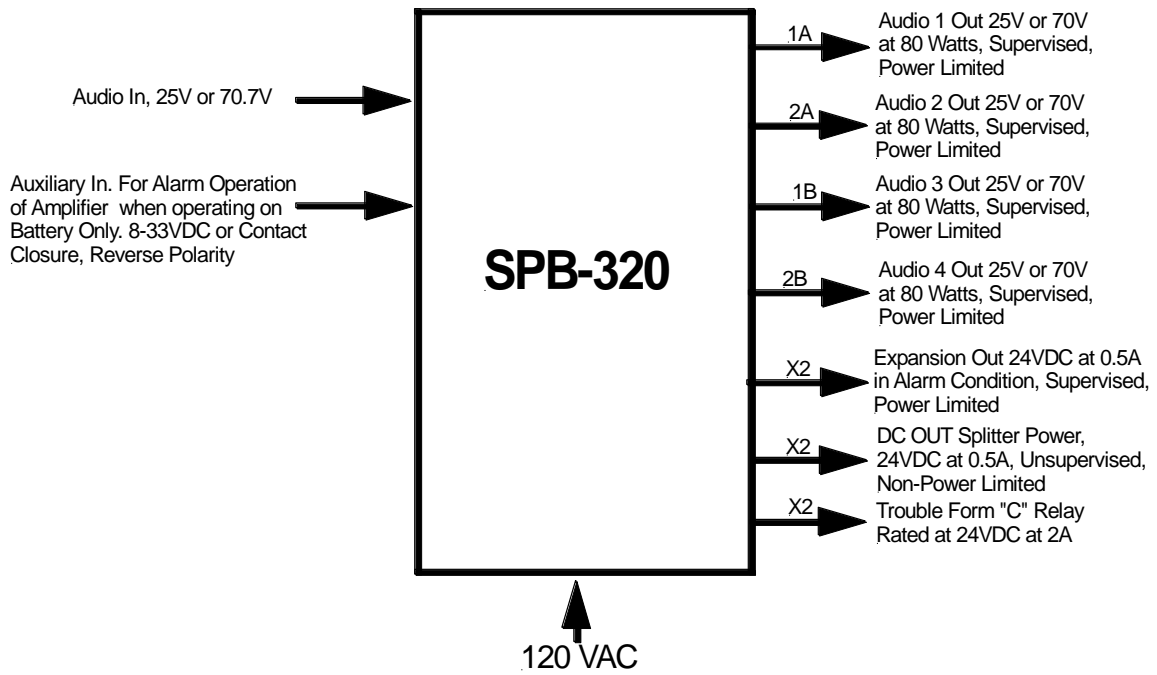

Figure 1 SPB-80/4 Audio Booster Panel, Basic Capabilities



Note 1: 25V is rated Class 2 and 70.7V is rated Class 3
 Figure 2 SPB-160 Audio Booster Panel, Basic Capabilities



Note 1: 25V is rated Class 2 and 70.7V is rated Class 3

Figure 3 SPB-320 Audio Booster Panel, Basic Capabilities

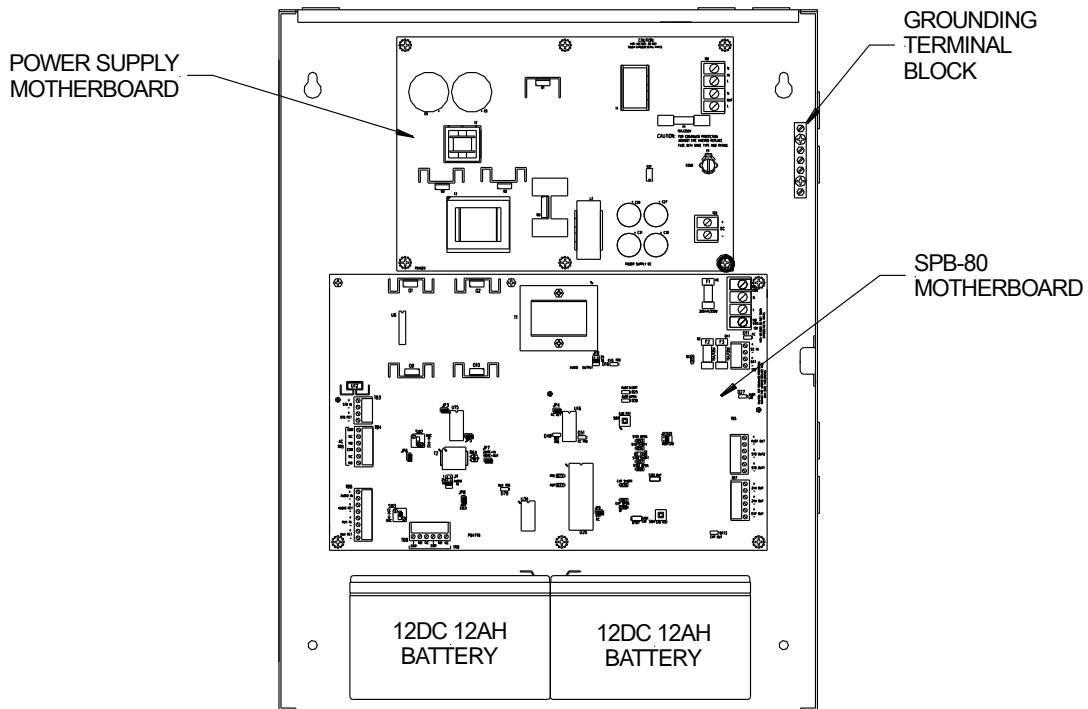

Figure 4 SPB-80/4 Audio Booster Panel

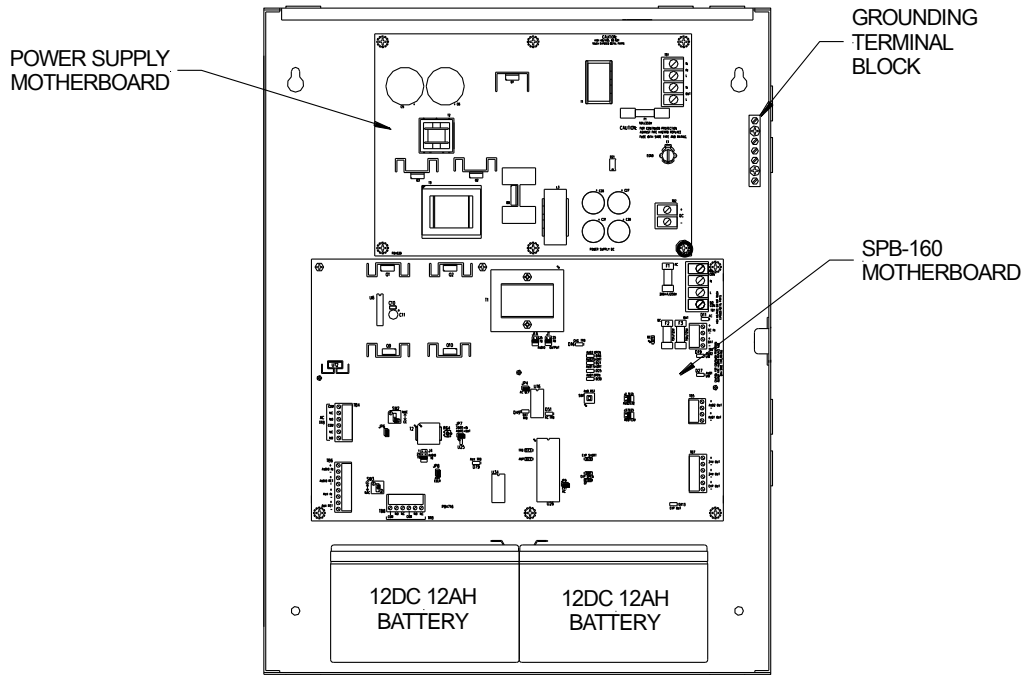

Figure 5 SPB-160 Audio Booster Panel

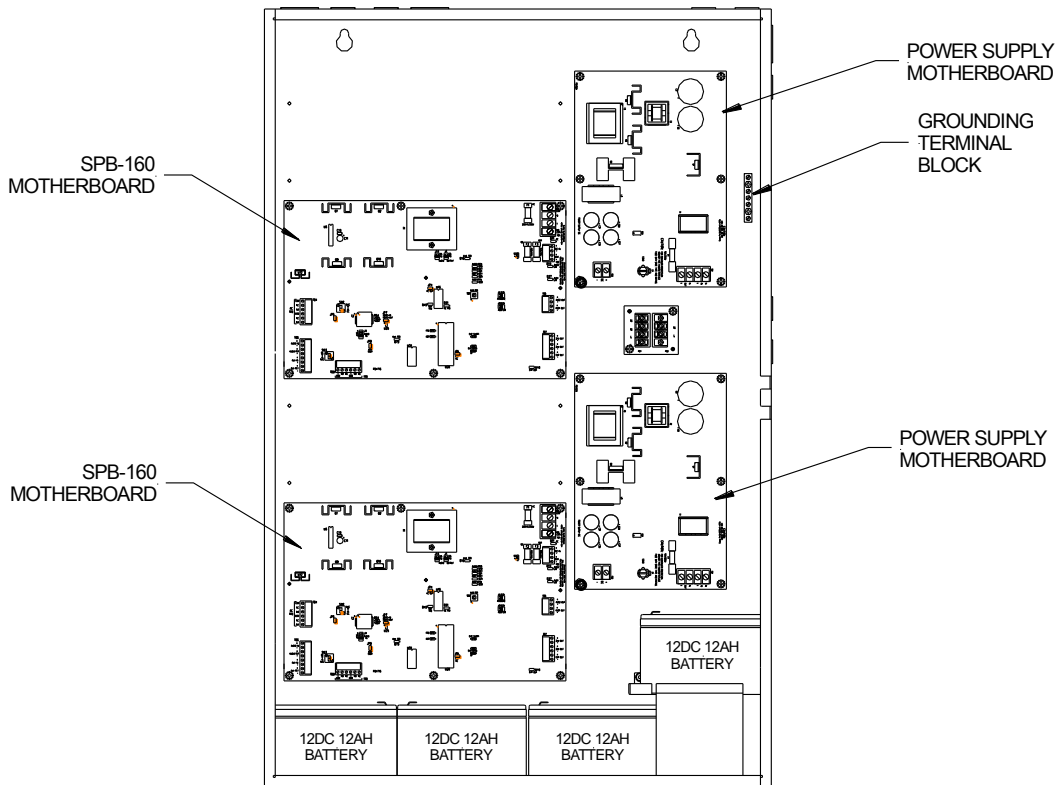



Figure 6 SPB-320 Audio Booster Panel

This page is left blank intentionally.

4 Installation

4.1 Introduction

Remember the lives of people depend upon the safe and proper installation of the voice evacuation system and the Series SPB Audio Booster Panel. Please read, understand, and follow the specific installation instructions set forth in this chapter carefully to avoid damage to the panel and equipment connected to it. Ensure that only qualified personnel in accordance with the procedures in this manual conduct the installation.

 **WARNING: Shut off all power before starting the installation. Electrical shock can cause death or serious injury.**

 **WARNING: Do not connect AC power or battery backup power until system wiring has been connected, modules have been installed, and field wiring has been inspected.**



CAUTION: The printed circuit board is sensitive to static electricity and has delicate components mounted on it. Before handling the board or any component on it, discharge any static electricity from your body by touching a grounded object such as a metal screw, which is connected to earth ground. Install the panel in a static-free area; properly attach grounded wrist straps before touching any static-sensitive areas.

If you or the installer have any questions about the installation, consult with should consult with the authorities having jurisdiction (AHJ), prior to installation.

4.2 General Installation Instructions

Figure 7 and Figure 8 show the location of wiring terminals used in the installation of each Series SPB Audio Booster. Table 1 identifies and describes the functions of the different wiring terminals.

4.2.1 Unpacking and Taking Inventory (new from outline)

Carefully unpack the panel and make sure each item described on the packing slip is present and undamaged.

1. Check the exterior of the shipping container(s) for any exterior damage, then the interior of the container(s).
2. Notify both the carrier and Cooper Wheelock immediately on the straight bill of lading (supplied by the carrier) if any damage is found both verbally and in writing; you may also request an inspection by the carrier. Such requests must usually be made within a specified time period from date of shipment. Cooper Wheelock is not responsible for damage to equipment occurring during shipping, and only furnishes replacement parts against a written purchase order. It is the customer's responsibility to file a claim with the carrier.
3. Follow any instructions Cooper Wheelock and/or the carrier may supply about possible damage.
4. If no damage is found, compare the contents of the Inventory List against the contents of the shipping container(s), to ensure receipt of all components.
5. Save all shipping materials (any "bubble wrap" or plastic) for possible future use. Store in a safe, dry location.

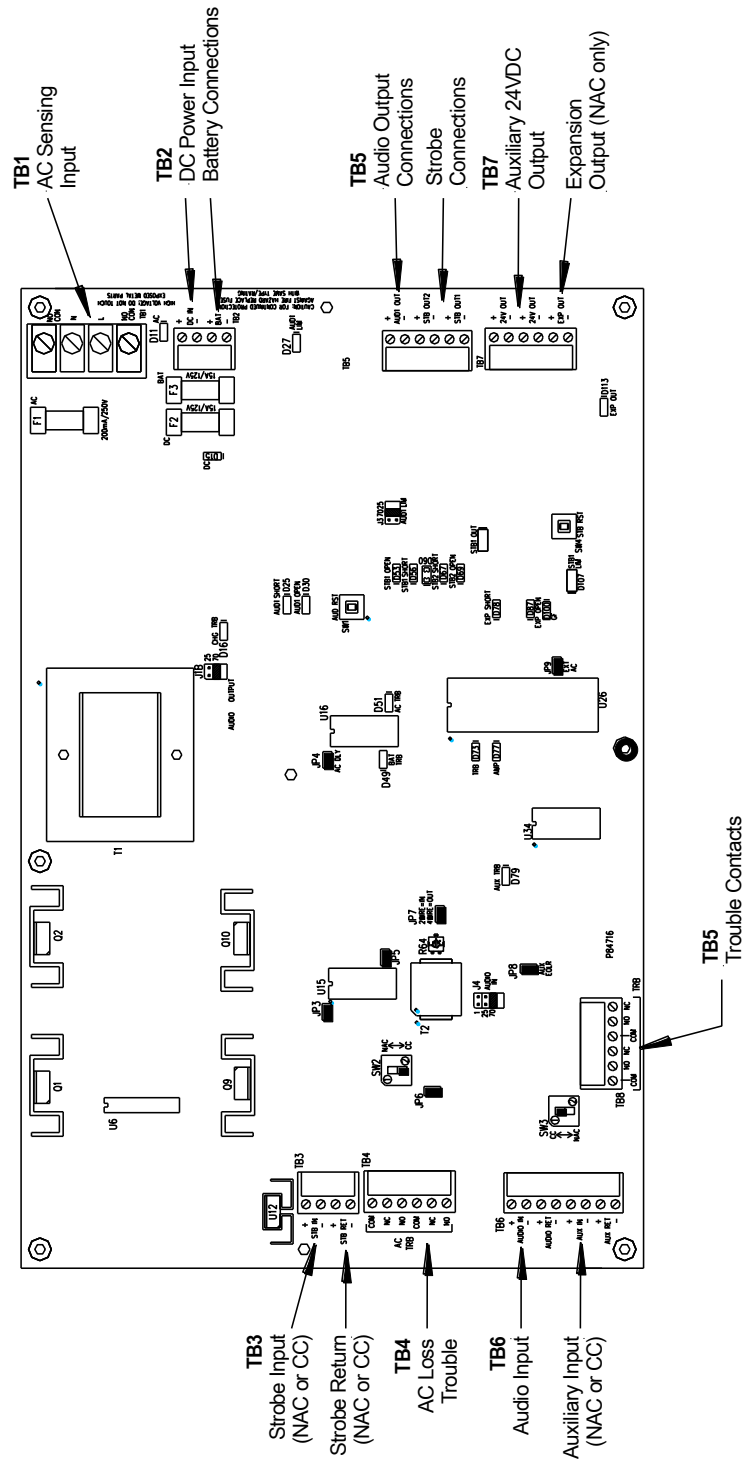

Figure 7 Location of Field Wiring Connections SPB-80/4

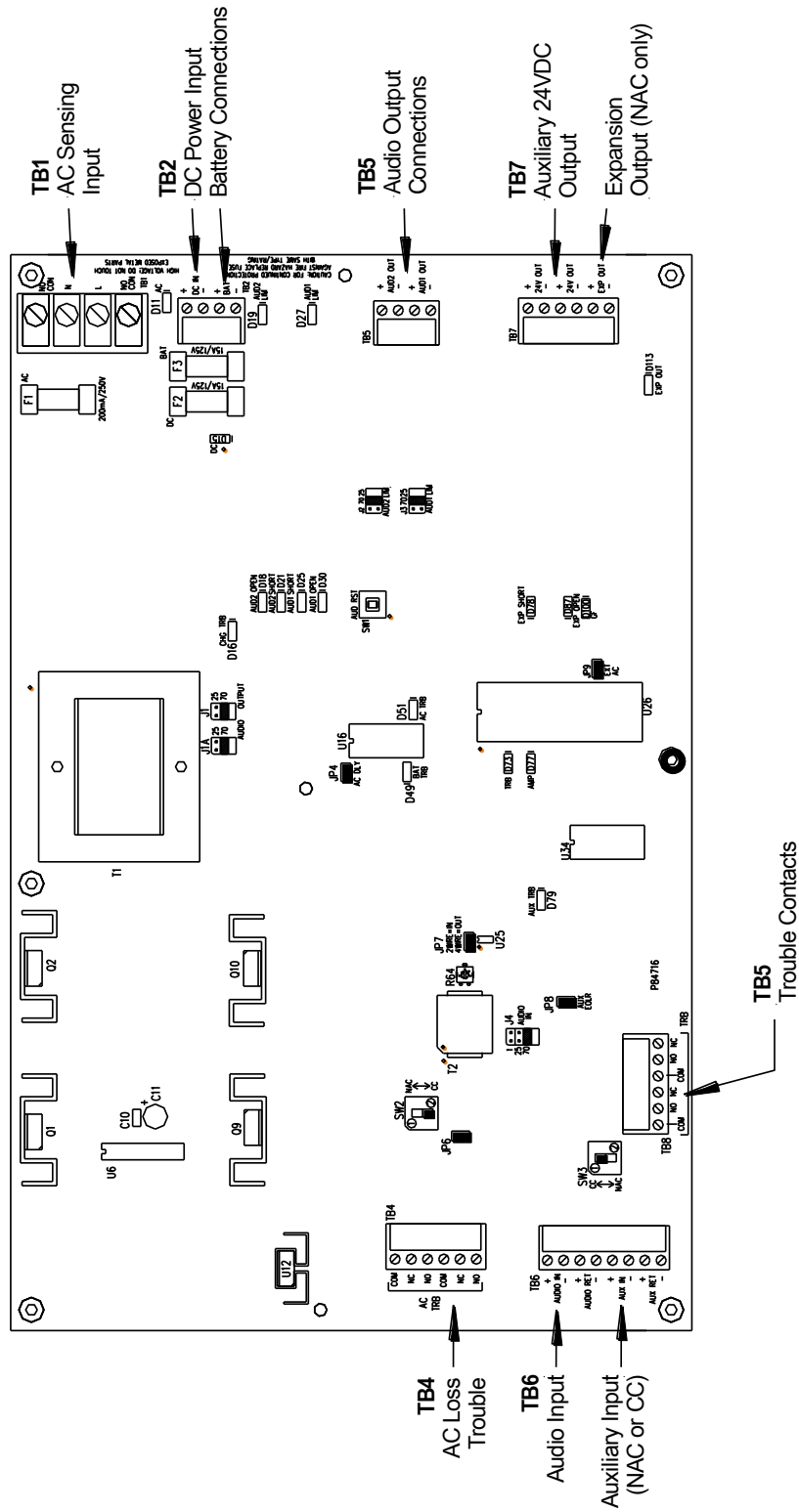

Figure 8 Location of Field Wiring Connections SPB-160/SPB-320

Table 1 Terminal Blocks Connection Definitions

	Symbol	Full Name	Definition
TB1	AC IN	AC sensing Input Connection	Factory connection senses proper AC Voltage input. Low AC or no AC input will light the AC LED and cause a trouble condition.
TB2	STB IN	Strobe Input (SPB-80/4 Only)	Power limited 8 to 33VDC (10mA) NAC power limited source or contact closure input. Initiates Strobe Outputs on the SPB-80/4 only
	STB RET	Strobe Return (SPB-80/4 Only)	Strobe Input Return - Used to continue strobe input circuit, connecting additional strobe input circuits from audio boosters, Strobe appliances or voice evacuation panel's 1/2W EOLR.
TB3	DC IN	DC Input	Factory wired 24VDC Input from power supply (SPBPS)
	BATTERY	Battery	24VDC Battery connection for battery charging and battery backup.
TB4	AC TRB	AC Trouble Reporting	Provides AC loss trouble when reporting to off-site location.
TB5	AUD2 OUT	Audio 2 Output (SPB-160 Only)	Audio Output #2 - Provides 25V or 70.7V, power limited audio output at 80 watts. Supervised using a UL Listed 10K Ohm 1/2W EOLR.
	AUD1 OUT	Audio 1 Output	Audio Output #1 - Provides 25V or 70.7V power limited audio output at 80 watts. Supervised using a UL Listed 10K Ohm 1/2W EOLR.
	STB2 OUT	Strobe 2 Output (SPB-80/4 Only)	Regulated 27VDC at 2.0A NAC power limited Supervised using a UL Listed 10K Ohm 1/2W EOLR.
	STB1 OUT	Strobe 1 Output (SPB-80/4 Only)	Regulated 27VDC at 2.0A NAC power limited Supervised using a UL Listed 10K Ohm 1/2W EOLR.
TB6 **	AUDIO IN	Audio Input	1V, 25V, or 70.7V power limited audio input. Blocking capacitor for DC Supervision. Power consumption is 1.2 Watts @ 70.7V and 0.25 Watts @ 25V.
	AUDIO RET	Audio Return	Audio Input Return. Used to continue Audio Circuit from the voice evacuation panel, connecting additional audio boosters, or voice evacuation panel's 1/2W EOLR.
	AUX IN	Auxiliary Input	8 to 33VDC (10mA) NAC power limited source or contact closure input. Used in the Four Wire mode. Applying an alarm input restores audio booster to full power from the power saver mode when panel is in battery backup mode.
	AUX RET	Auxiliary Return	8-33VDC (10mA) NAC power limited source (only) Auxiliary input return. Used to connect to additional audio boosters through the voice evacuation panel.
TB7	EXP OUT	Expansion Out	27VDC at 0.5A power limited circuit energized when a signal is applied to AUX IN or Strobe In. Reverse polarity Supervised using a UL Listed 10K Ohm 1/2W 1/2W EOLR.
	DC OUT	DC Output	27VDC at 0.5A, non-power limited used for splitter power only.
TB8	TRB	Trouble Reporting	Provides trouble reporting when not connected to SP40S (OR SPMNS).

** The default jumper setting for J4 audio input is 70 volts. Only use the 1 volt setting when wiring the SP4-RMX module. Failure to do so can cause damage to the motherboard.

4.2.2 Mounting the Audio Booster

1. Mount the panel and optional expansion modules in the desired locations as described in more detail in section 4.5.
2. Mount any additional wiring boxes or junction boxes needed to interconnect field wiring.
3. Connect conduit fittings or bushings as needed through the knockouts provided on the top and bottom of the panel.

4.2.3 Installing Field Wiring Connections

NOTE: The terminal blocks on the Series SPB Audio Booster are removable. To remove a terminal block, pull the block straight up from the circuit board, as shown in the figure below. Attach wires to the desired connections, and then plug the terminal block back on the board, being careful to match the pins.

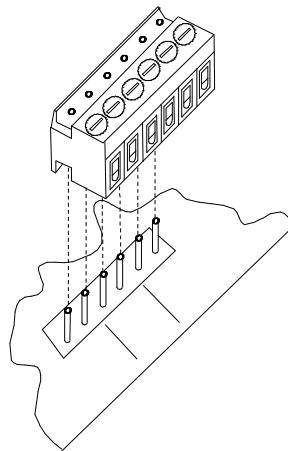

Figure 9 Removable Terminal Block

1. Install field wiring in conduit when required, following the most current National Electrical Code (NFPA-70) and local codes for the type of system being installed.
2. Make all necessary connections at any additional wiring or junction boxes.
3. Separate power limited and non-power limited wires.

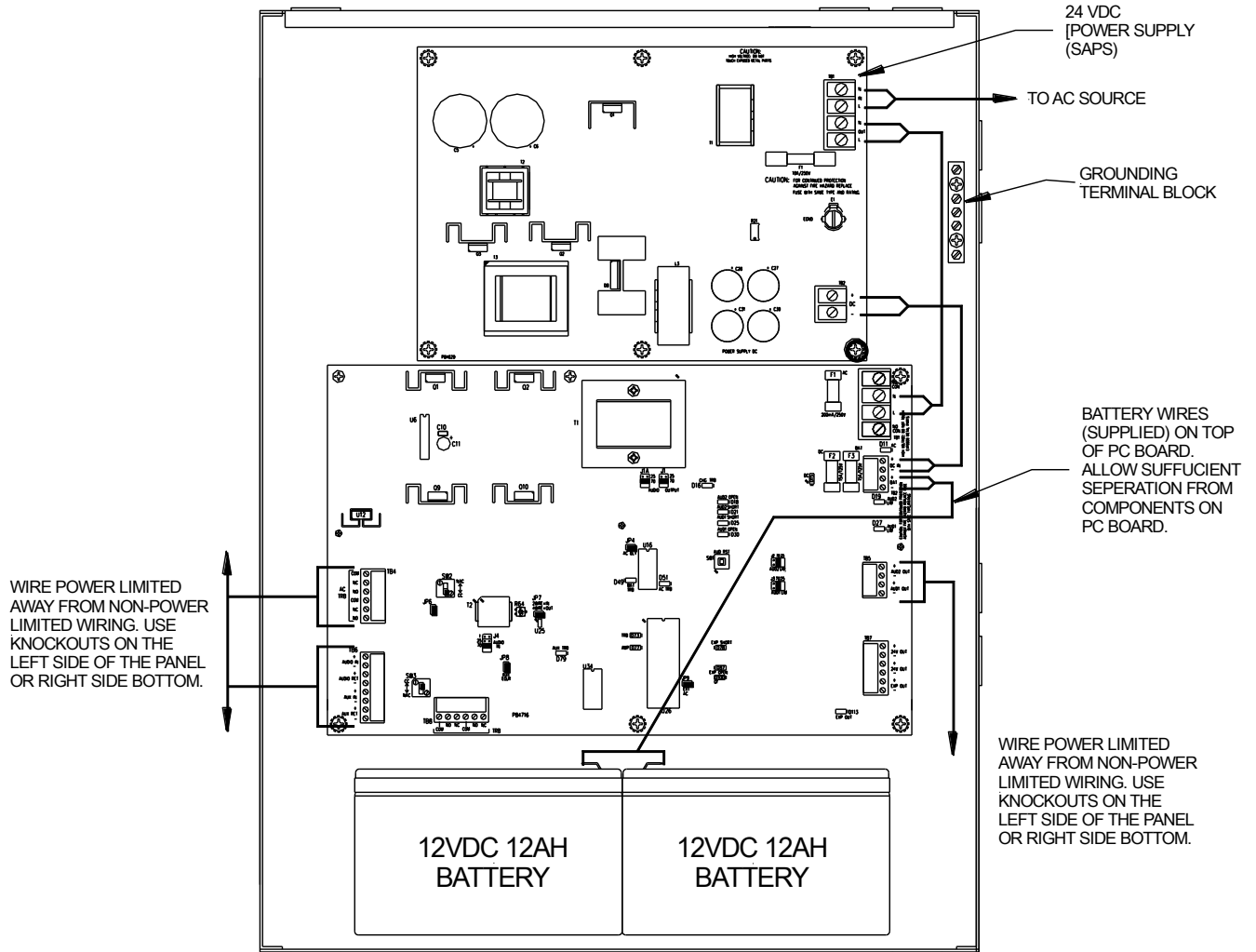

Figure 10 Power Limited and Non-Power Limited Wiring



CAUTION: Provide proper strain relief for all wiring not in conduit.

NOTE: Shielded wire is not required on any circuit. If shielded wire is used, connect the shields to the ground terminal strip.

4.2.4 Installing Audio and Auxiliary Input Connections

The audio input circuit (AUD IN) consists of either the power limited 1V, 25V, or 70.7V circuit of the SP40S (OR SPMNS) panel. The input uses a blocking capacitor for DC supervision. The audio return (AUD RET) can be used to link other Series SPB Audio Boosters to the host voice evacuation panel, additional speakers powered by the host panel, or connecting the host panel's 1/2W EOLR.

The auxiliary input circuit is used to trigger the Series SPB Audio Booster to return to full power from a reduced power mode when operating on the backup battery supply. The input can be selected to be a power-limited, 8-33VDC NAC circuit or a contact closure. This is selected by switching SW3. The AUX RET is used to link additional Audio Boosters to the Auxiliary Circuit or connecting the host panel's 1/2W EOLR.

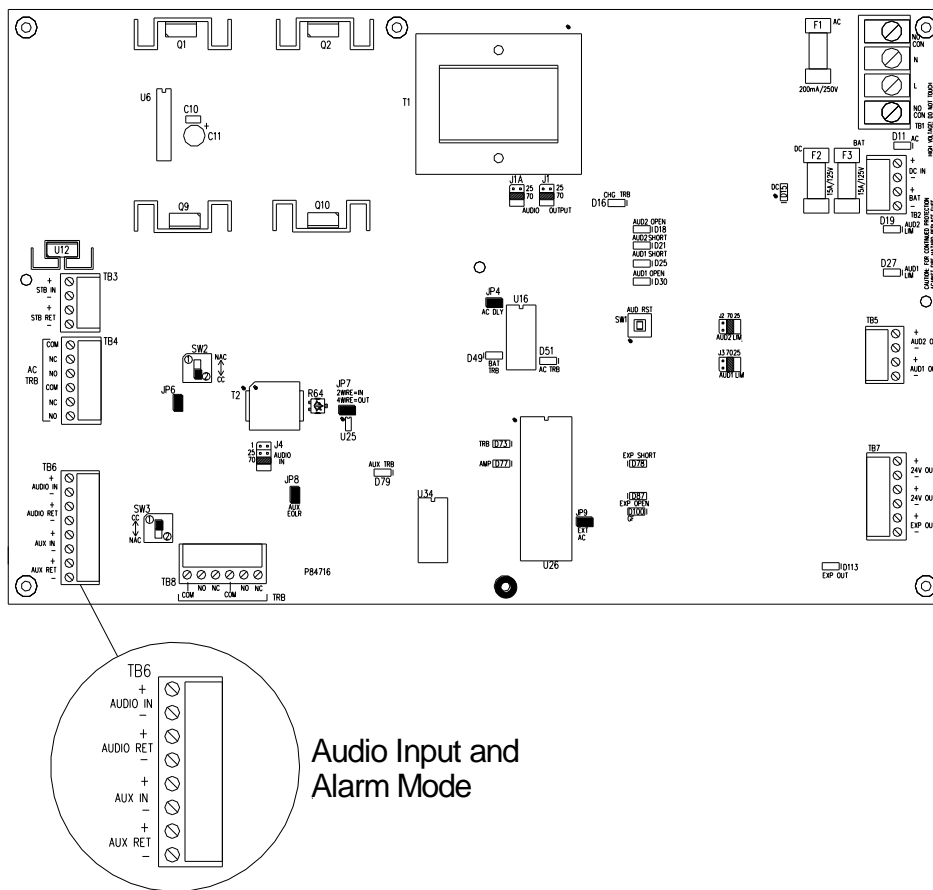

Figure 11 Audio and Auxiliary Input Connections

1. Connect the audio output from the voice evacuation panel to the AUD IN terminals. Connect the SP40S (OR SPMNS) panel's 1/2W EOLR to the AUD RET terminals.
2. Select the proper audio input voltage, using jumper J4 (Input Voltage Select). Location of the jumper is shown in Figure 30, Figure 31 and Figure 32.
3. Connect the NAC or Contact Closure input to the AUX IN terminals. Connect the voice evacuation panel's 1/2W EOLR to the AUD RET terminals.

4.2.5 Installing Strobe Input Connections (SPB-80/4)

The strobe input circuit (STB IN) consists of either a power limited 8-33VDC regulated NAC circuit input or a contact closure input. The input uses reverse polarity for supervision. The strobe return (STB RET) can be used to link other Series SPB Audio booster strobe NAC circuits to the host voice evacuation panel, additional strobes powered by the host panel, or connecting the host panels 1/2W EOLR. The strobe output provides a synchronized output for compatible Cooper Wheelock, Inc. synchronized strobes.

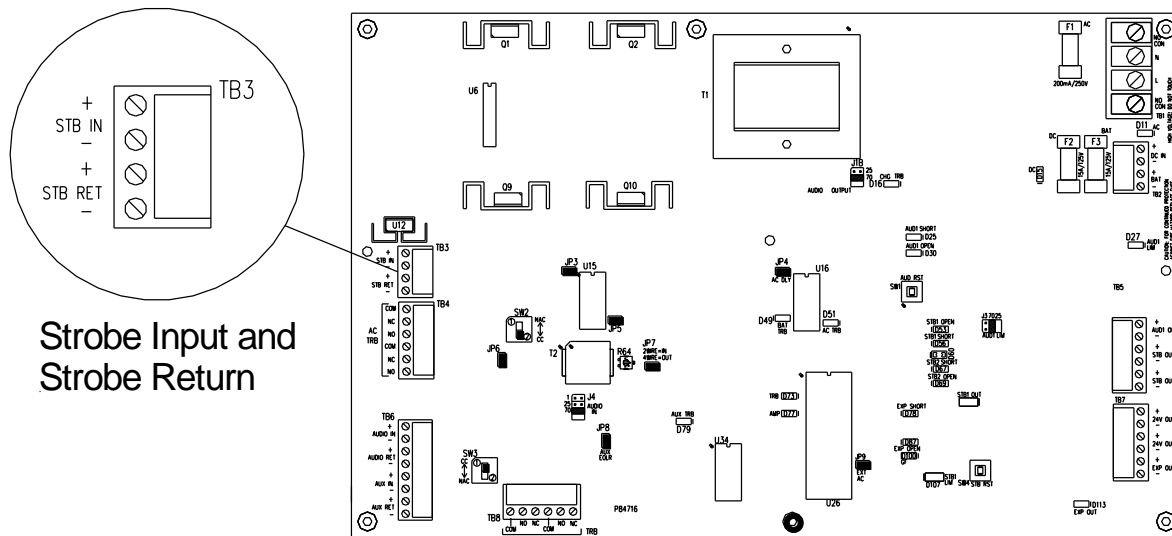

Figure 12 Strobe Input Connections (SPB-80/4)

Connect the strobe input to the STB IN terminals. Connect the proper device or connection to the STB RET.

4.2.6 Installing Audio and Strobe Output Circuit Connections

NOTE: Install a UL Listed 10K Ohm 1/2W EOLR on both AUD1 and AUD2 (SPB-160 and SPB-320 only) outputs for supervision whether they are used or not. If the audio circuit is used, place the UL Listed 10K Ohm 1/2W EOLR on the last audio appliance on the circuit. Failure to do so causes an open condition, causing the TROUBLE LED D73 to turn on as well as the respective OPEN LED to light.

NOTE: AUD1 and AUD2 are two separate 80-watt, Class B, power-limited audio output circuits. **Do not wire AUD1 and AUD2 together.**

NOTE: The maximum line impedance for the strobe circuit is 40 ohms.

NOTE: STB1 and STB2 are two separate 2-Amp, Class B, power-limited strobe regulated NAC circuits. **Do not wire STB1 and STB2 together.**

Figure 13 shows the audio and strobe output connections as they are on the SPB-80/4. Notice that there are two strobe outputs.

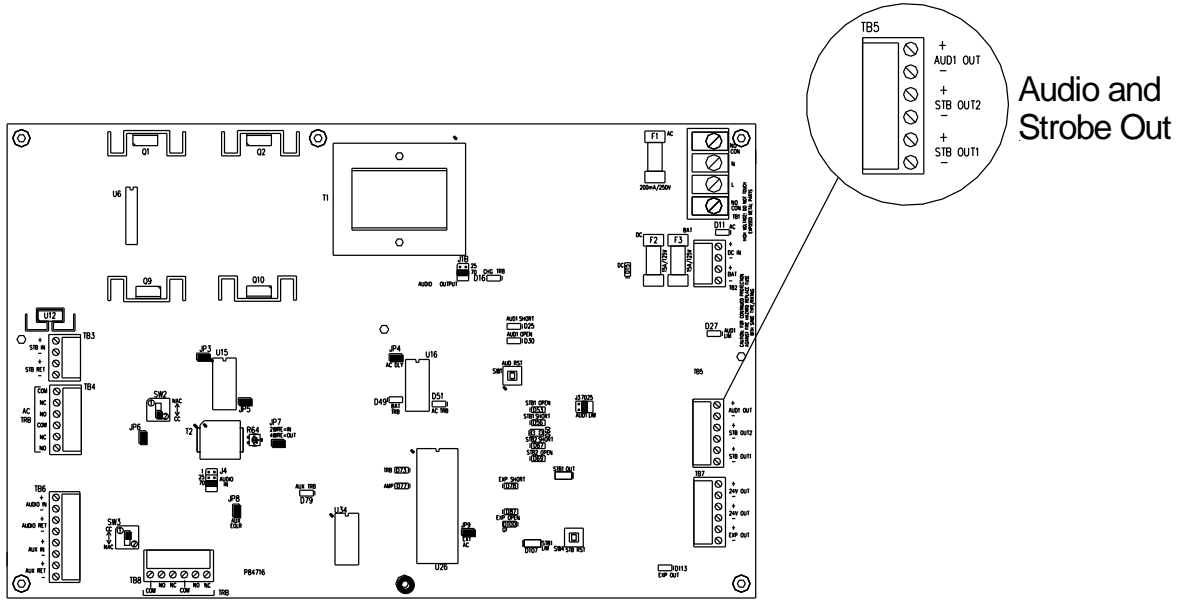

Figure 13 Audio and Strobe Output Connections (SPB-80/4)

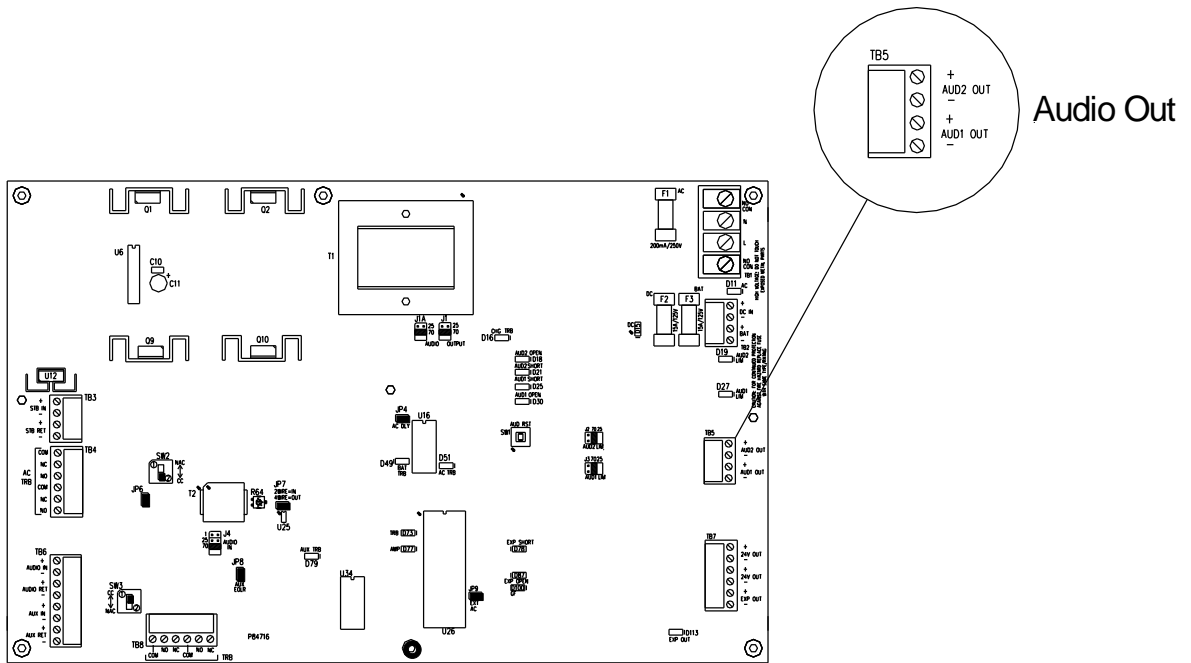

Figure 14 Audio Output (SPB-160 and SPB-320) Connections

1. Connect Audio Appliance circuit to Audio Output (AUD OUT) connection(s).
Figure 13 and Figure 14 are enlarged diagrams of the referred areas. The Audio Output(s) is supervised. A UL Listed 10K Ohm, 1/2W EOLR is required at the end of the circuit for proper supervision.
 2. For the SPB-80/4, select the proper output voltage (25V or 70V) using the Audio Output Select Jumper J1B and J3. Figure 30 for location.
 3. For the SPB-160, select the proper output voltage (25V or 70V). Use Jumpers J1A and J3 for AUD1 and Jumpers J1 and J2 for AUD2. See Figure 31 for location.
 4. Connect Strobe Appliance circuit to STB Outputs (STB1 OUT, STB2 OUT) connections. Figure 13 is an enlarged diagram of the referred area. The strobe outputs are supervised. A UL Listed 10K Ohm, 1/2W EOLR is required at the end of the circuit for proper supervision.
 5. Select the proper strobe-operating mode (Wheelock sync, Cooper Wheelock Pass through Sync, or 24VDC constant), Select Jumper JP5. See Figure 31 for location.
- Note: Both outputs of the SPB-80/4 are synchronized. If system wide synchronization is required, remove JP5 for pass-through operations.

4.2.7 Installing Expansion Output and Trouble Contact Connections

The purpose of the Expansion Output (EXP OUT) is to provide a 27VDC at 0.5A supervised, power-limited output when the Audio Booster audio output is operating. This allows additional Series SPB Audio Boosters to be connected by having the EXP OUT connect to the AUX IN of the next Audio Booster. The strobe input circuit on an SPB-80/4 does not cause the expansion output to energize.

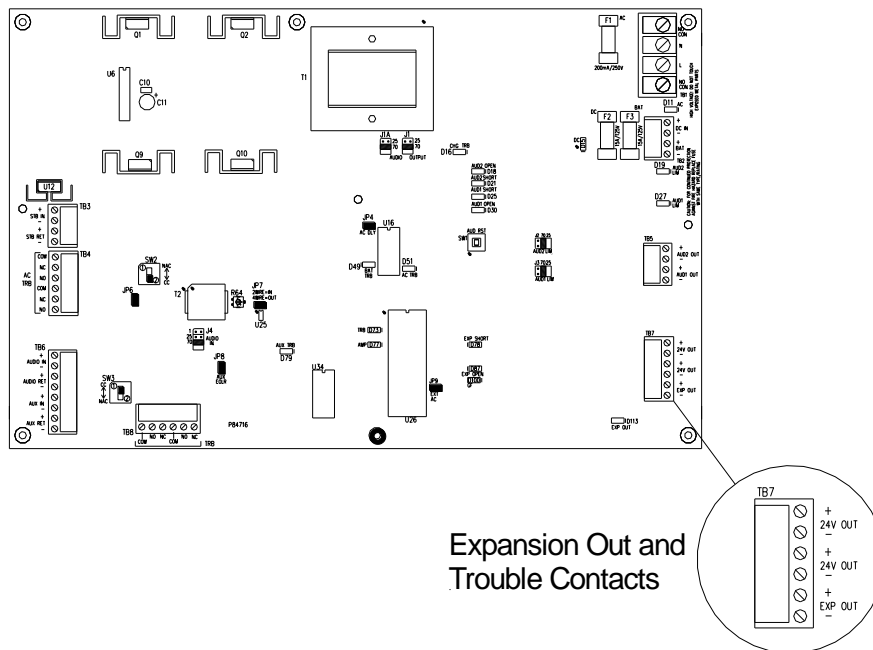

Figure 15 Alarm and Trouble Connections

The Trouble relay changes state whenever a trouble condition occurs on the Audio Booster circuit board and when the TROUBLE LED D73 lights. As shown in Figure 15, connecting to the common terminal (C) and the normally open terminal (NO) would prevent current flow through the relay contacts in the normal operating condition. A trouble condition causes the relay to switch states, allowing current to flow. When there is no power (DC IN or BATTERY) the common and normally open contacts are shorted.

1. If required, connect the Expansion Out. Ensure that a UL Listed 10K Ohm 1/2W EOLR is connected for supervision.
2. Connect External Trouble circuit to the proper Trouble (TRB) connections.
3. Connect the panel to earth ground, following the National Electrical Code (NEC) and local codes for the type of system being installed.

Wire gauge selection of the earth ground wiring should involve consideration of all factors, including maximum allowable wire resistance and length. The panel is tied to earth ground by connecting the ground terminals to an earth ground. The location of the ground terminal strip within the panel is shown in Figure 29 for both the SPB-160 and the SPB-80/4.

4.2.8 Installing Power and Battery Connections

Wiring to the DC IN is factory installed from the Power Supply Module (SPB).

BATTERY terminals are used to connect the backup batteries to the panel for recharging and backup power. The UL approved battery connection is 24VDC up to 33Ah. The enclosure can accommodate up to 12Ah. See Figure 16.

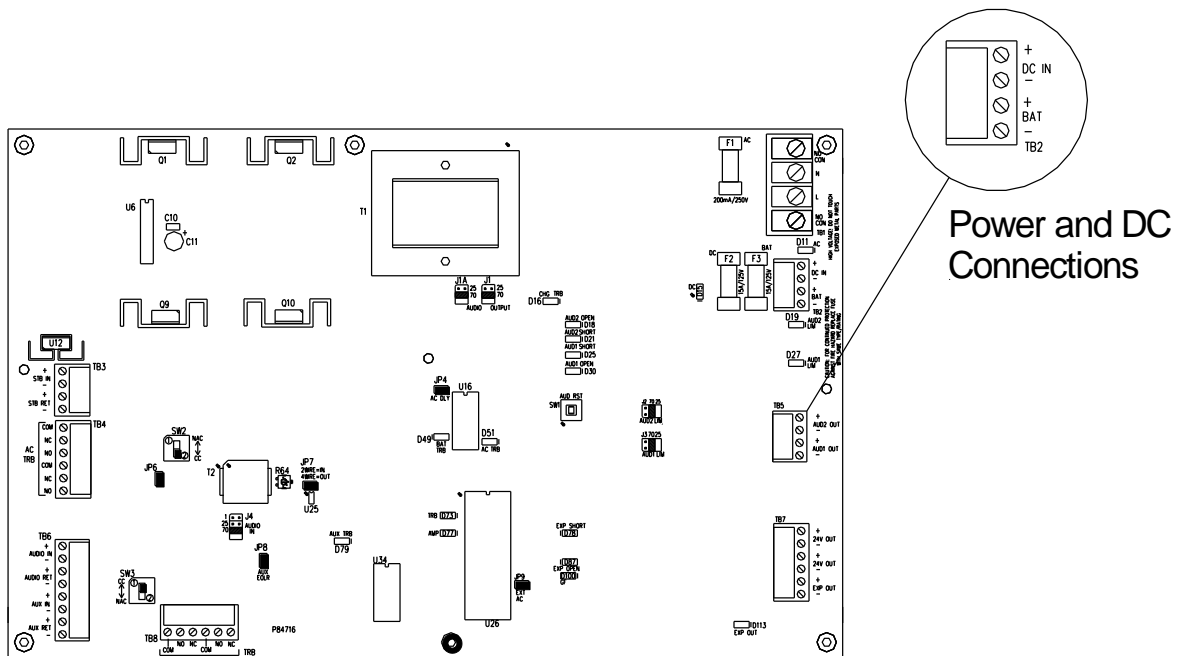

Figure 16 Power and Battery Connections

NOTE: DC OUT is a 27VDC at 0.5A output for powering splitter modules only.



CAUTION: Do not connect input voltage to any equipment until the field wiring has been tested, inspected, and approved.

1. Check the integrity of all field wiring. Confirm that specified wiring is installed, and that there is continuity between required points (no open circuits), with no unwanted shorts to other conductors, chassis, or earth ground.
 - a. Verify that the field wiring complies with the instructions of this manual and the detailed wiring diagram prepared for this installation.
 - b. Ensure that no unwanted voltages are present on circuit conductors and ground.
 - c. Test all ungrounded connectors for electrical isolation from ground.
 - d. Measure and record the resistance of each NAC circuit. Conduct this test reversing polarity.
2. Calculate and Install properly sized backup batteries as described in Sections 4.8 and 4.9. The SPB Audio Boosters are UL approved for 24VDC at a maximum of 33Ah. The enclosure can accommodate up to 12Ah. Larger batteries may necessitate a separate battery box.
3. Perform the System Checkout Procedure as described in Section 4.6.



WARNING: Two different sources of power may be connected to this unit. Disconnect both sources of power before servicing. Failure to disconnect both power sources before servicing could result in serious injury or death to you and/or others.

4.3 Two-Wire Audio and Four-Wire Audio Modes

The Series SPB Audio Booster can be connected to the SP40S (OR SPMNS) in four different modes. Refer to Table 4-1 for a description of these modes.

Table 2 Series SPB Wiring Modes

Wiring Mode	When To Use	Effects	Section
Two-Wire Mode with AC Loss reported on Main Trouble Contacts	This mode is generally used when no secondary operations (BGM, Telephone Paging, etc.) are being used on the SP40S (OR SPMNS) and the least amount of connection wires is desirable.	If one Audio Booster has any trouble, then all Audio Boosters connected to the SP40S (OR SPMNS) lose secondary operations.	4.2.1.
Four-Wire Mode with AC Loss reported on Main Trouble Contacts	This mode is generally used when secondary operations (BGM, Telephone Paging, etc.) are being used on the SP40S (OR SPMNS).	If one Audio Booster has any trouble, only that Audio Booster loses secondary operations.	4.2.2.
*Two-Wire Mode with AC Loss reported on AC TRB Contacts	This mode is generally used when no secondary operations (BGM, Telephone Paging, etc.) is being used on the SP40S (OR SPMNS).	If one Audio Booster has an AC Loss trouble, then all Audio Boosters connected to the SP40S (OR SPMNS) lose secondary operations.	4.2.3.
*Four-Wire Mode with AC Loss reported on AC TRB Contacts	This mode is generally used when secondary operations (BGM, Telephone Paging, etc.) are being used on the SP40S (OR SPMNS).	If one Audio Booster has an AC Loss trouble, only that Audio Booster loses secondary operations.	4.2.4.

* Note: One of these modes may be required by Underwriters Laboratories when system troubles need to be transmitted to an off-site location.

4.3.1 Two-Wire Audio Mode with AC Loss Reported on Main Trouble Contacts

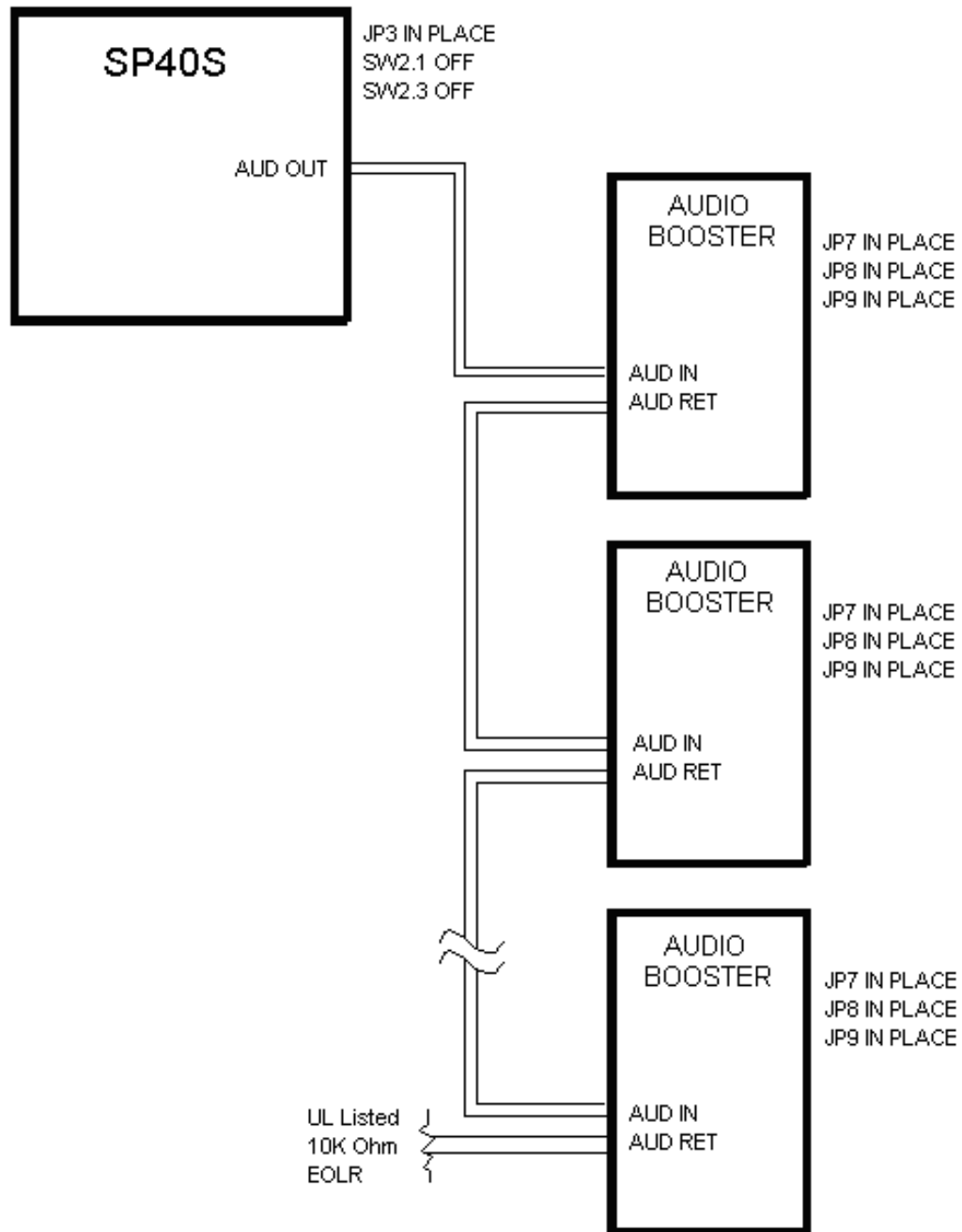

Figure 17 Two-Wire Audio Mode with AC Loss Reported on Main Trouble Contacts

4.3.2 Four-Wire Audio Mode with AC Loss Trouble Reported on Main Trouble Contacts

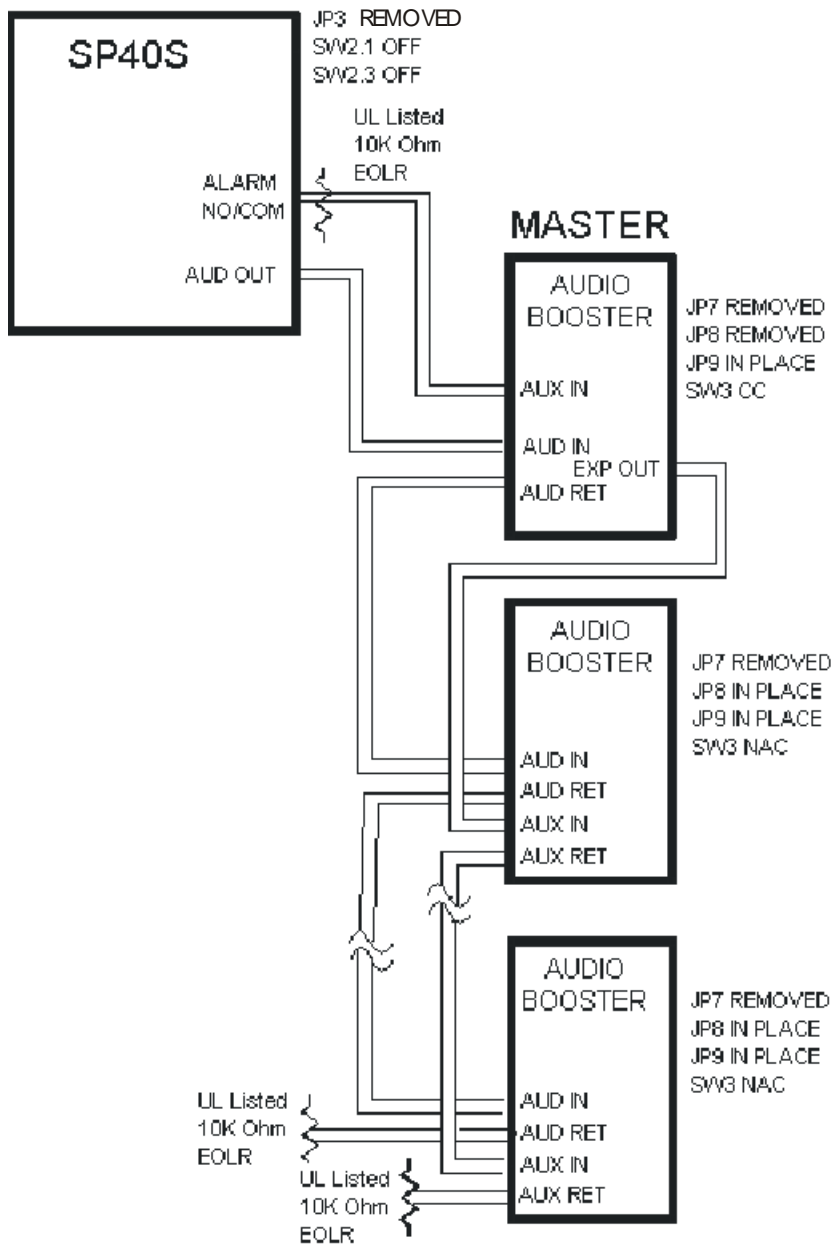

Figure 18 Four-Wire Audio Mode with AC Loss Reported on Main Trouble Contacts

4.3.3 Two-Wire Mode with AC Loss Reported on AC TRB Contacts

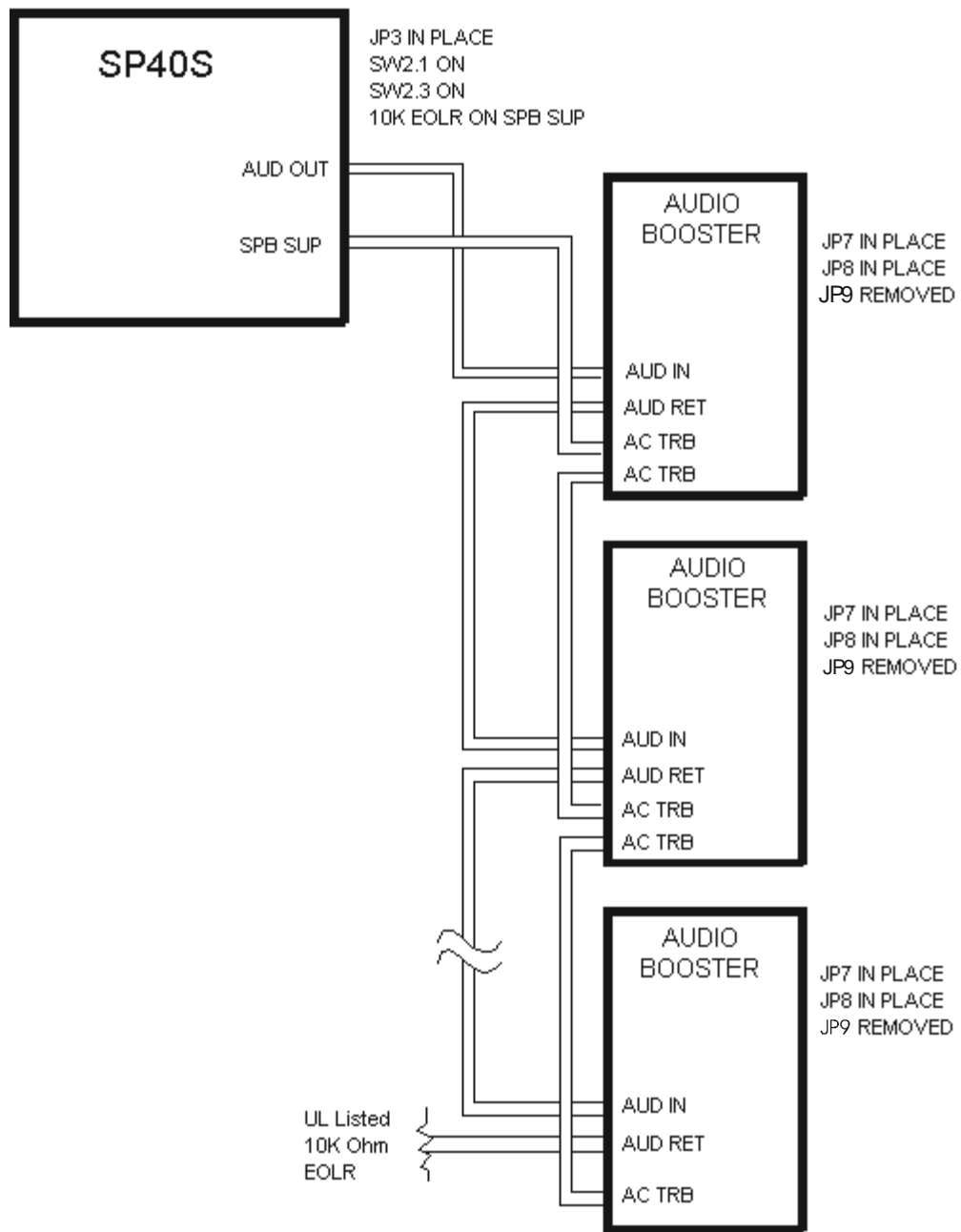

Figure 19 Two-Wire Audio Mode with AC Loss Reported on AC TRB Contacts

4.3.4 Four-Wire Audio Mode with AC Loss Trouble Reporting on AC TRB Contacts

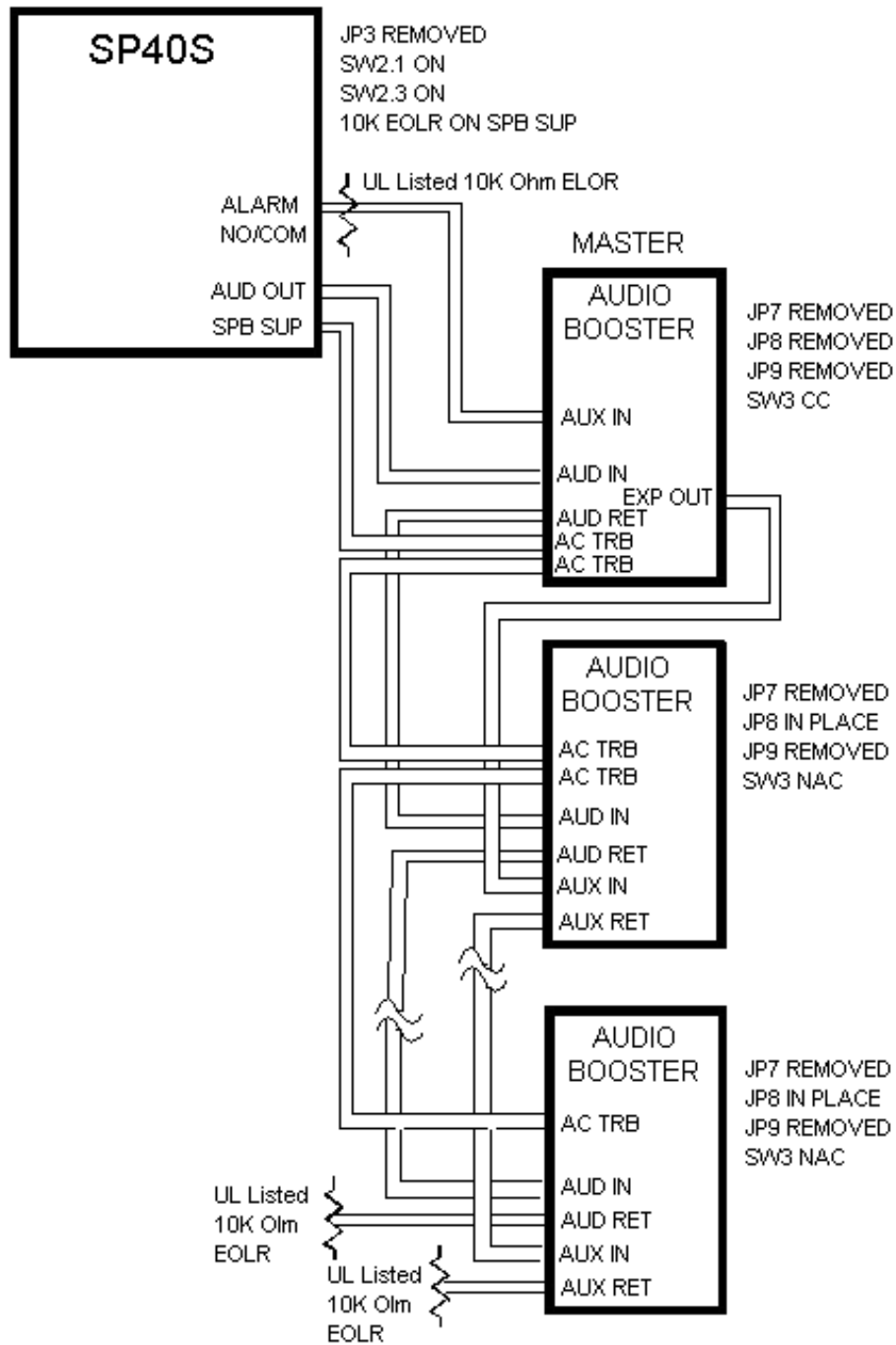

Figure 20 Four-Wire Audio Mode with AC Loss Trouble Reporting on AC TRB Contacts

4.4 Wiring the Panel

4.4.1 Wiring Guidelines

The National Electrical Code defines two types of circuits for protective signaling systems: power limited circuits and non-power limited circuits. All outputs (AUD1 OUT, AUD2 OUT, STB1-OUT, STB2-OUT and EXP OUT) are power-limited circuits.

- Connect AUD-IN with 1V, 25V, or 70.7V input and STB-IN, AUX IN and TROUBLE CONTACTS with 8VDC to 33VDC inputs to a power-limited source. AC, BATTERY and DC OUT are non-power limited circuit.

⚠ WARNING: Route all Series SPB Audio Booster audio wiring away from any high voltage or high current wiring (such as AC or DC power wiring, audio power wiring, and motor or relay actuation wiring). Failure to do so may cause electrical shock, resulting in serious injury or death to you and/or others.



CAUTION: The National Electric Code limits the maximum number of conductors that can be installed in conduit and wiring boxes depending on the size of the conduit, the volume of the boxes, and the gauge of the wire used. Make sure that wiring used for installation complies with the latest NEC, NFPA, Local, State, County or Province requirements.

4.4.2 Field Wiring Connections

All wiring terminals are designed to accept #12 AWG through #18 AWG wiring. Proper wire gauge considerations for the Notification Circuit must take into account current requirements versus length of run.

4.4.3 Visual Notification Appliance Output Wiring (SPB-80/4 only)

Wire gauge selection involves consideration of all factors including, wire loop length, maximum current draw of each appliance, number of appliances, and maximum voltage drop allowable. The SPB-80/4 has two strobe regulated NAC circuits, while the SPB-160 and SPB-320 have none.

Each strobe NAC has a regulated 24VDC, 2.0 Amps maximum output.

Strobe NAC meets Class B supervision requirements for notification appliance circuits.

For the strobe output circuit, install a UL Listed 10K Ohm, 1/2W EOLR across the last visual notification appliance. If the output is unused, place a UL Listed 10K Ohm, 1/2W EOLR across the output terminals.

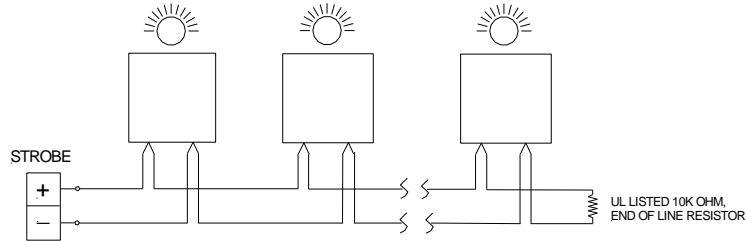

Figure 21 Wiring Diagram for Visual Only Notification Appliances (SPB-80/4 Only)



CAUTION: Do not loop wire under terminals. Break wire run to provide supervision of the connection.

4.4.4 Speaker Notification Appliance Output Wiring

Wire gauge may vary for each audio appliance output on the panel. When:

Speaker (with transformer) appliances are used with supervised audio amplifier module. Wire gauge selection should involve consideration of all factors including, wire length, appliance power ratings, and the number of appliances.

The two amplified outputs are either a selectable 25V or 70.7V audio output, rated for 80 watts maximum. The SPB-80/4 has one audio output, the SPB-160 has two, and the SPB-320 has four. For the SPB-320, both SPB-160 modules must be set up for the same voltage.

The output meets Class B supervision requirements for notification appliance circuits.

For the audio output circuit, install a UL Listed 10K Ohm, 1/2W EOLR installed across the last notification appliance. If the output is unused, place a UL Listed 10K Ohm, 1/2W EOLR across the output terminals.

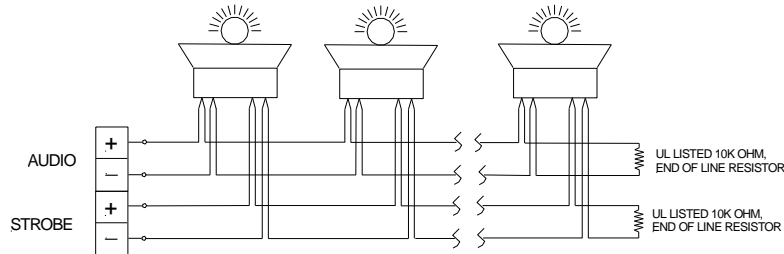

Figure 22 Wiring Diagram for Combination Audio/Visual Notification Appliances (SPB-80/4 Only)



CAUTION: Do not loop wire under terminals. Break wire run to provide supervision of the connection.

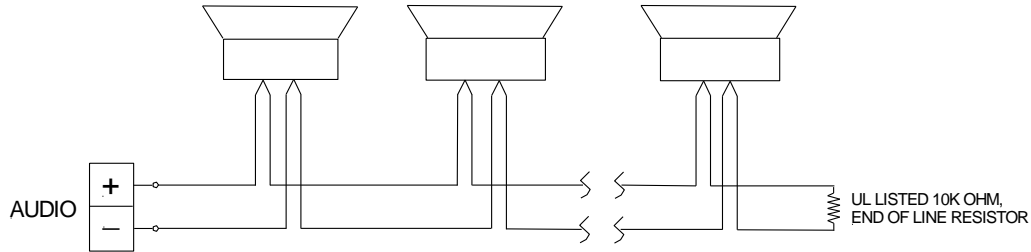

Figure 23 Wiring Diagram for Audio Only Notification Appliance Output



CAUTION: Do not loop wire under terminals. Break wire run to provide supervision of the connection.

4.4.5 Trouble Output Contact Wiring

The locations of the Trouble Status Output Connections are shown in Figure 7 (SPB-80/4) and Figure 8 (SPB-160 and SPB-320). A magnified view of this area on the motherboard is shown in Figure 24. When connected to the SP40S (OR SPMNS), troubles will be transferred via the Audio Input terminals.

Wire gauge selection of the system Trouble Status output contact wiring should involve consideration of all factors including, wire length, maximum current capacity, and maximum voltage drop allowable.

The system Trouble Status output contact is Form C, rated for 2.0 amps at 24VDC, resistive load. For a detail of the system Trouble Status output contact terminal connections (shown in the trouble position), see the figure immediately below.

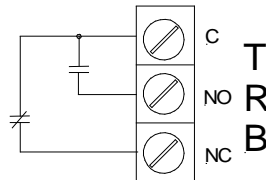

Figure 24 Trouble Status Relay Contacts

4.4.6 Power Connection Requirements

4.4.6.A SPB-80/4 and SPB-160 Power Connection Requirements

The Audio Booster Panel contains a 27VDC Power Supply (SPB). Batteries are charged from the battery charger located on the Audio Booster PC Board.

1. Connect the AC input power to the Line (L) and Neutral (N) terminals on the Power Supply PC Board (SPBPS) as shown in the figure immediately below.

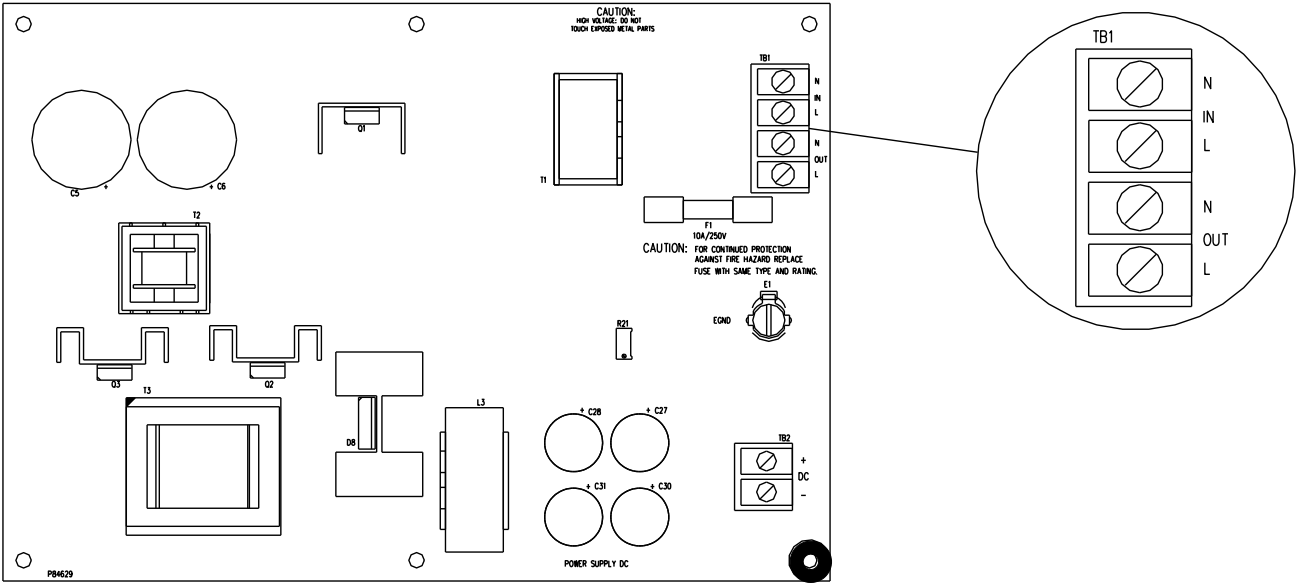

Figure 25 Input Power Connection Location, SPB Power Supply

2. Connect the battery to the BATTERY terminals on the Audio Booster PC Board shown in Figure 27. The DC OUT on the Audio Booster is used to power the splitter modules only.
3. Calculate proper backup battery requirements, using Section 4.8, Battery Care and Backup Battery Calculations. Section 4.9 is the AC and battery installation procedures.

4.4.6.B SPB-320 Power Connection Requirements

The SPB-320 Audio Booster Panel contains two 24VDC Power Supplies (SPBPS). AC input power to the Line (L) and Neutral (N) terminals on the Power Supply Motherboard is factory connected from the Terminal block. Connect the AC input power to the Line (L) and Neutral (N) terminals on the Terminal block as shown in the figure below.

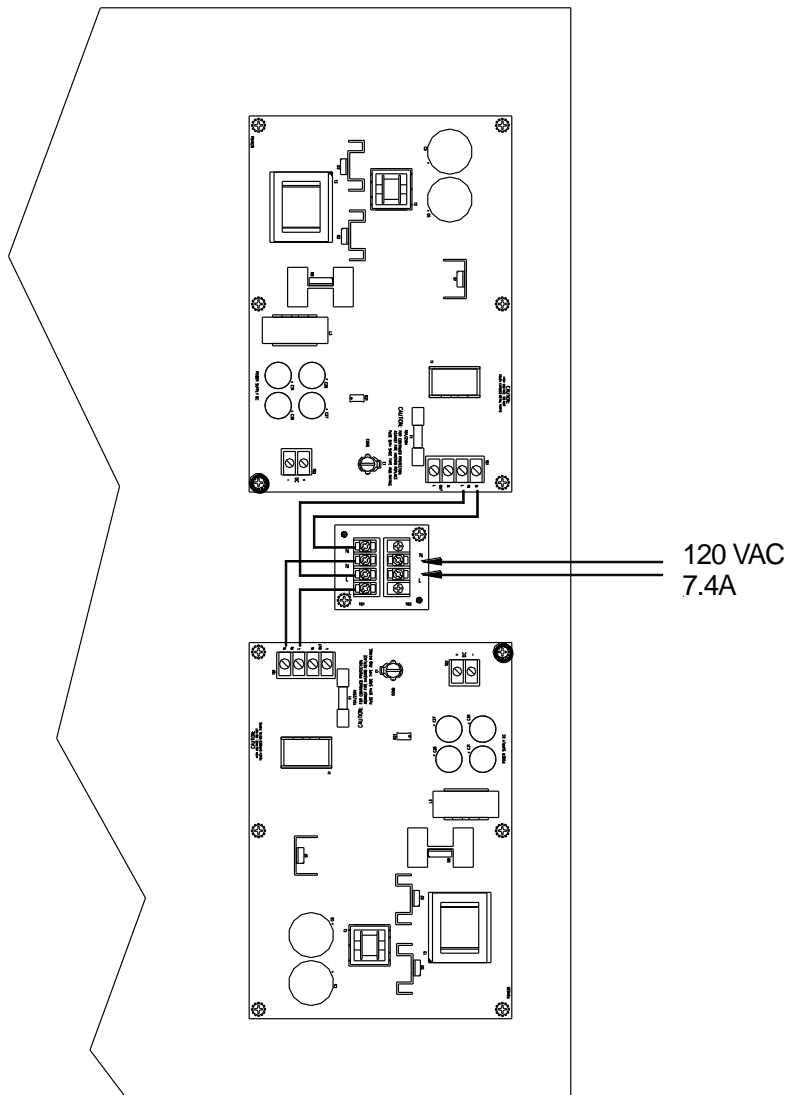

Figure 26 Input Power Connection Location
on the SPB Power Supply (SPB-320 only)

Batteries are charged from battery charger located on each SPB-160 module.

1. Connect each set of two batteries BATTERY terminals on each SPB-160 Audio Booster PC Board as shown in Figure 27.
2. Connect the RED fused wire to the (+) positive terminal.

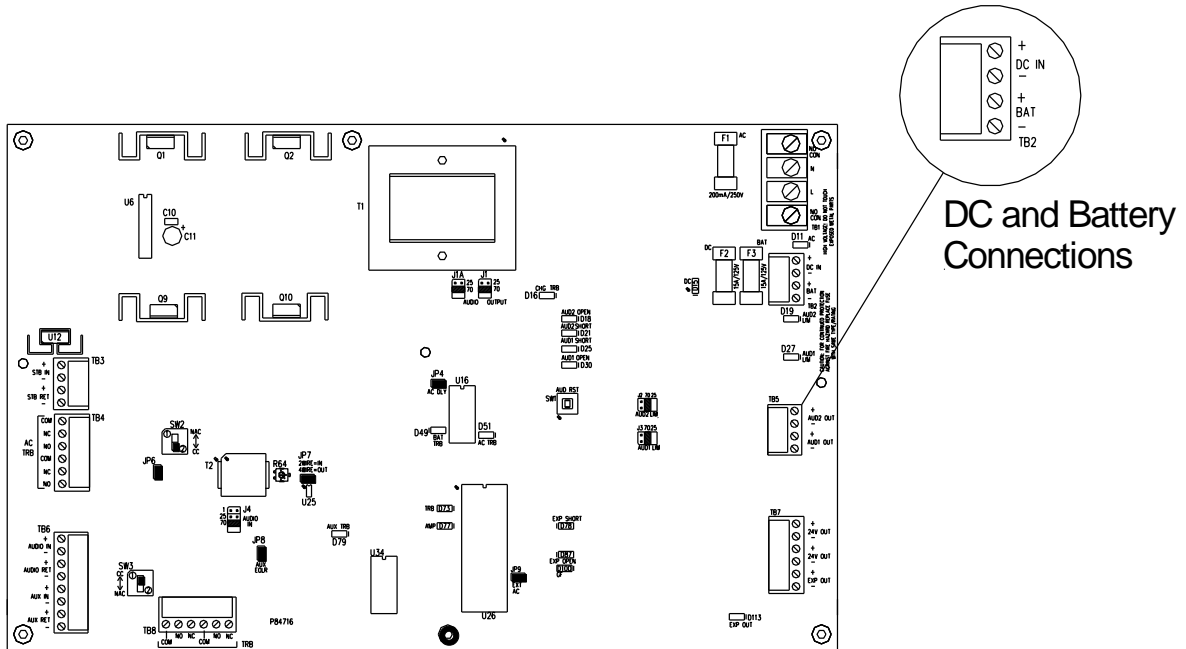

Figure 27 DC and Battery Connection on the Audio Booster Motherboard

The DC OUT on the Audio Booster is used to power the splitter modules only.

3. Calculate proper backup battery requirements, using Section 4.8, Battery Care and Backup Battery Calculations. Section 4.9 is the AC and battery installation procedures.

4.5 Mounting the Panel

4.5.1 Locating the Panel



CAUTION: Mount the panel in a location within the environmental limits specified for indoor/day control panels. **DO NOT** locate the panel in a hazardous area.

1. For the SPB-80/4 and SPB-160, see Figure 28 for panel mounting hole layout; for the SPB-320, see Figure 29.
2. Mark and drill mounting holes for appropriate screws and anchors to ensure secure mounting to the type of surface at the selected location.
3. Prevent dust and dirt contamination of the Series SPB Audio Booster panel during installation. This contamination can interfere with the operation and reduce the life of the equipment.
4. Open the door and mount the Series SPB Audio Booster panel at the selected location. **Use care to avoid damage to the module during installation.** Do not apply excessive pressure to the PC board or its components, including field wiring terminals and connectors.

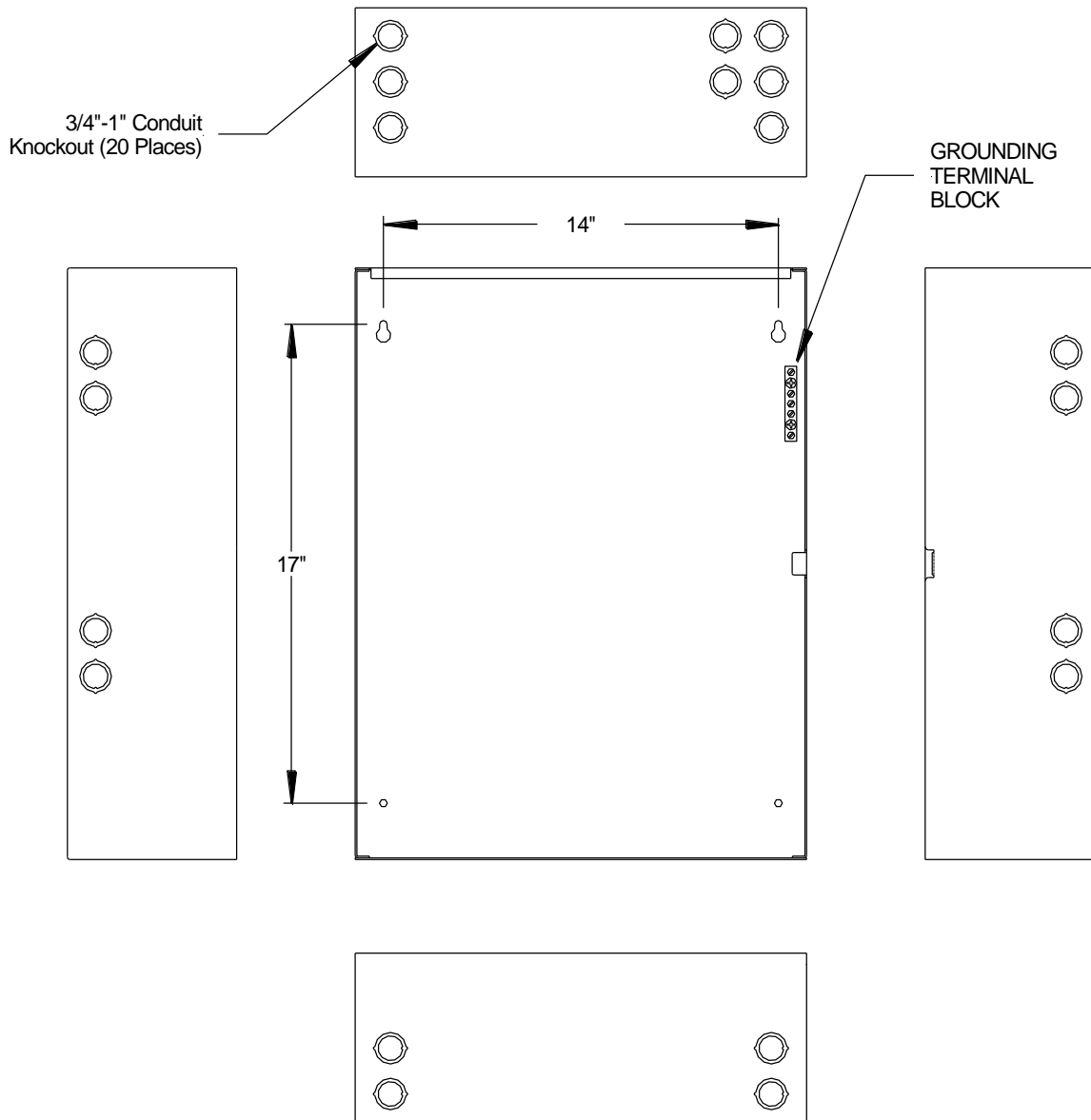

Figure 28 SPB-80/4 and SPB-160 Audio Booster Panel Mounting and Grounding Location

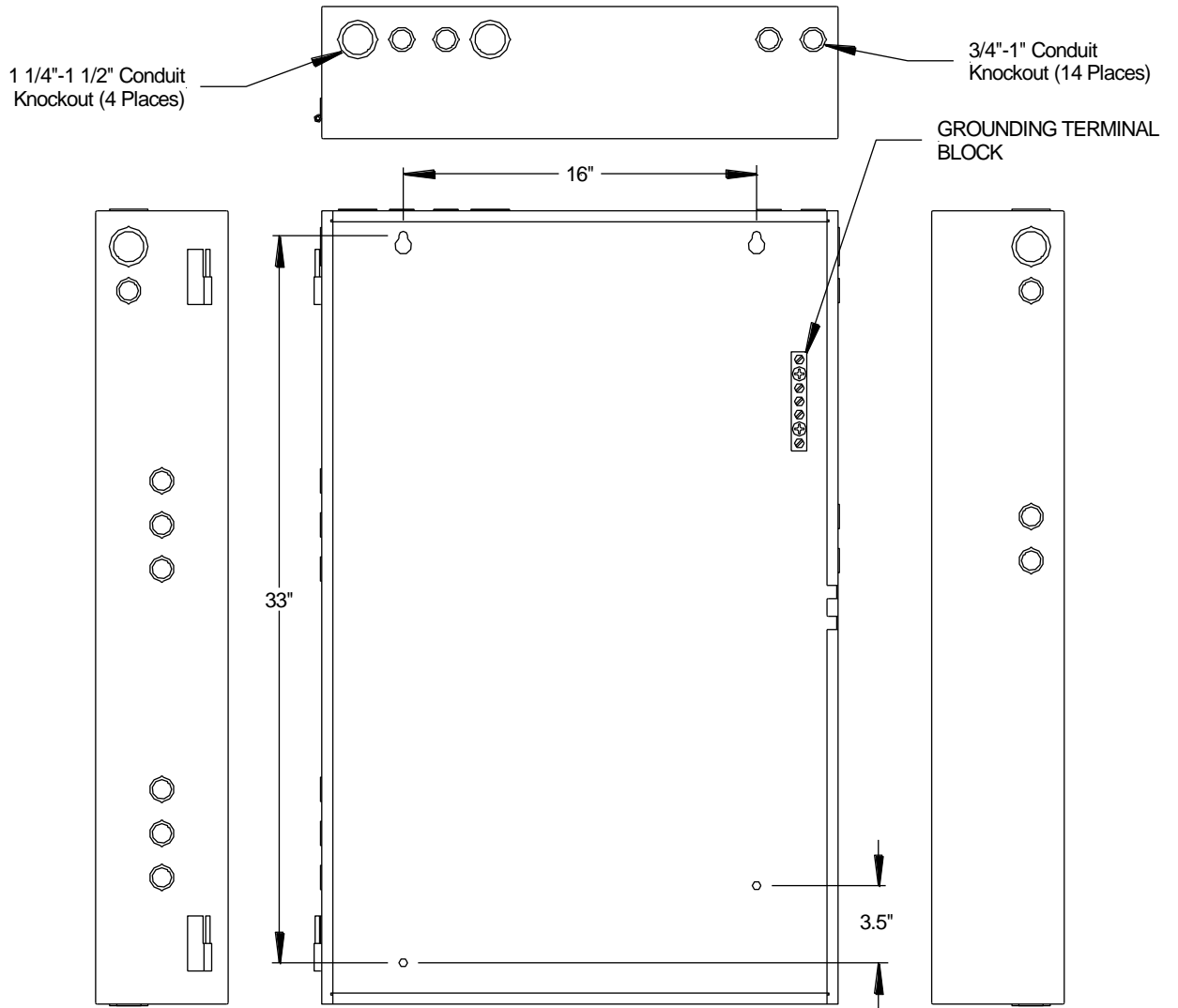

Figure 29 SPB-320 Audio Booster Panel

4.6 Performing System Checkout

For guidelines on testing notification systems, refer to the latest NFPA 72 code.

4.6.1 System Control Settings

Figure 30 and Figure 31 show the location of the different jumpers and switches used to configure the Series SPB Audio Boosters. Table 3 identifies and explains the functions of the different jumpers and switches. The following procedures are basic setup for the various panels.

1. Ensure that the AC and Battery Power are not connected.
2. Select the proper audio output (25V or 70V) by using the two jumpers (SPB-80/4 J1B and J3) (SPB-160 Audio 1 - J1A and J3, Audio 2 - J1 and J2).
3. Connect the speaker circuit(s) to terminal block TB5 AUD OUT. Verify that the speaker circuit has a UL Listed 10K Ohm, 1/2W EOLR.
4. For SPB-80/4, if applicable, connect the strobe circuit to TB5 STB1 OUT and STB2 OUT. Verify that the strobe circuit has a UL Listed 10K Ohm, 1/2W EOLR.
5. If Strobe synchronization is to be defeated, remove Jumper JP5 Strobe Synchronization Defeat. (SPB-80/4 only).

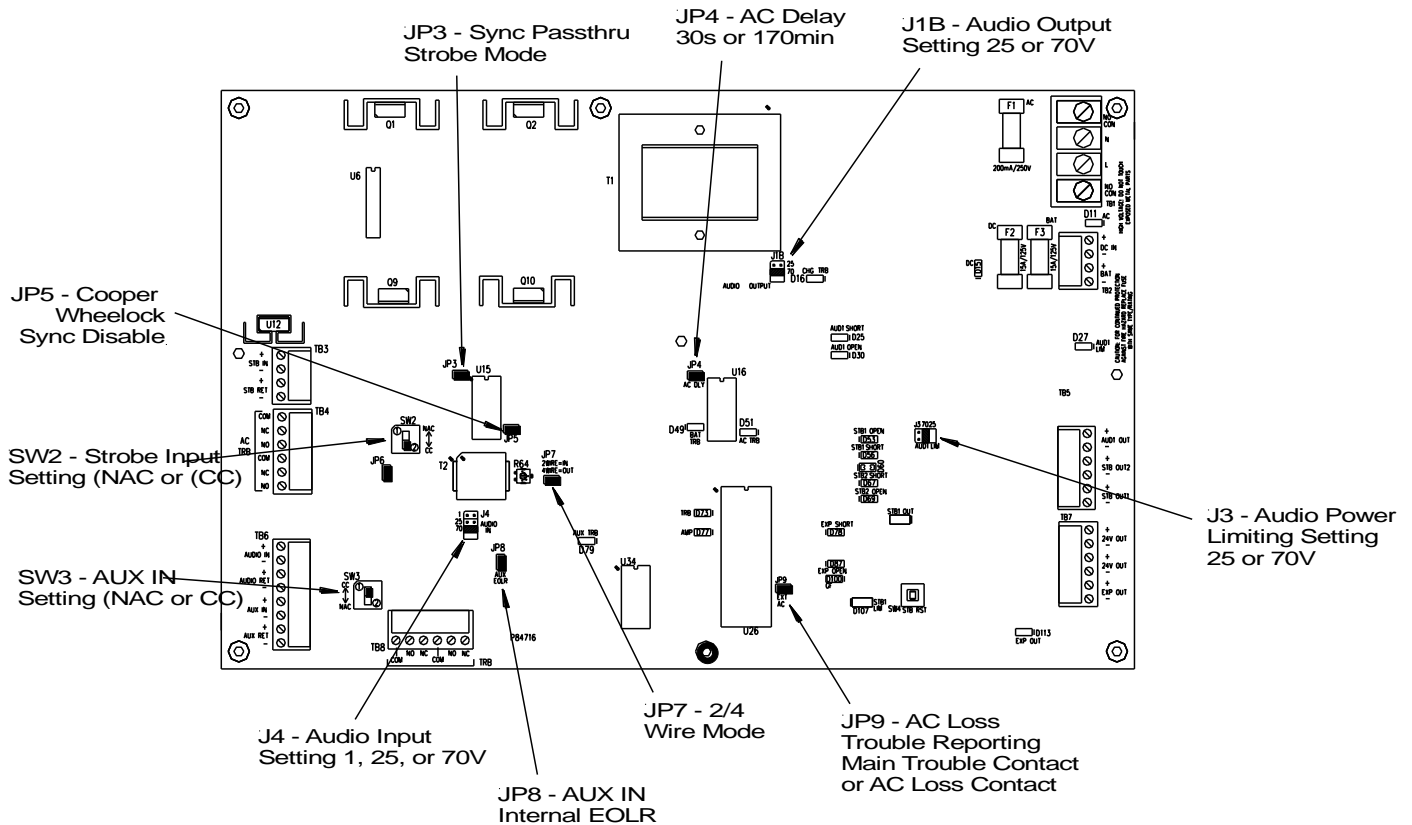

Figure 30 Jumper/Switch Locations on SPB-80/4

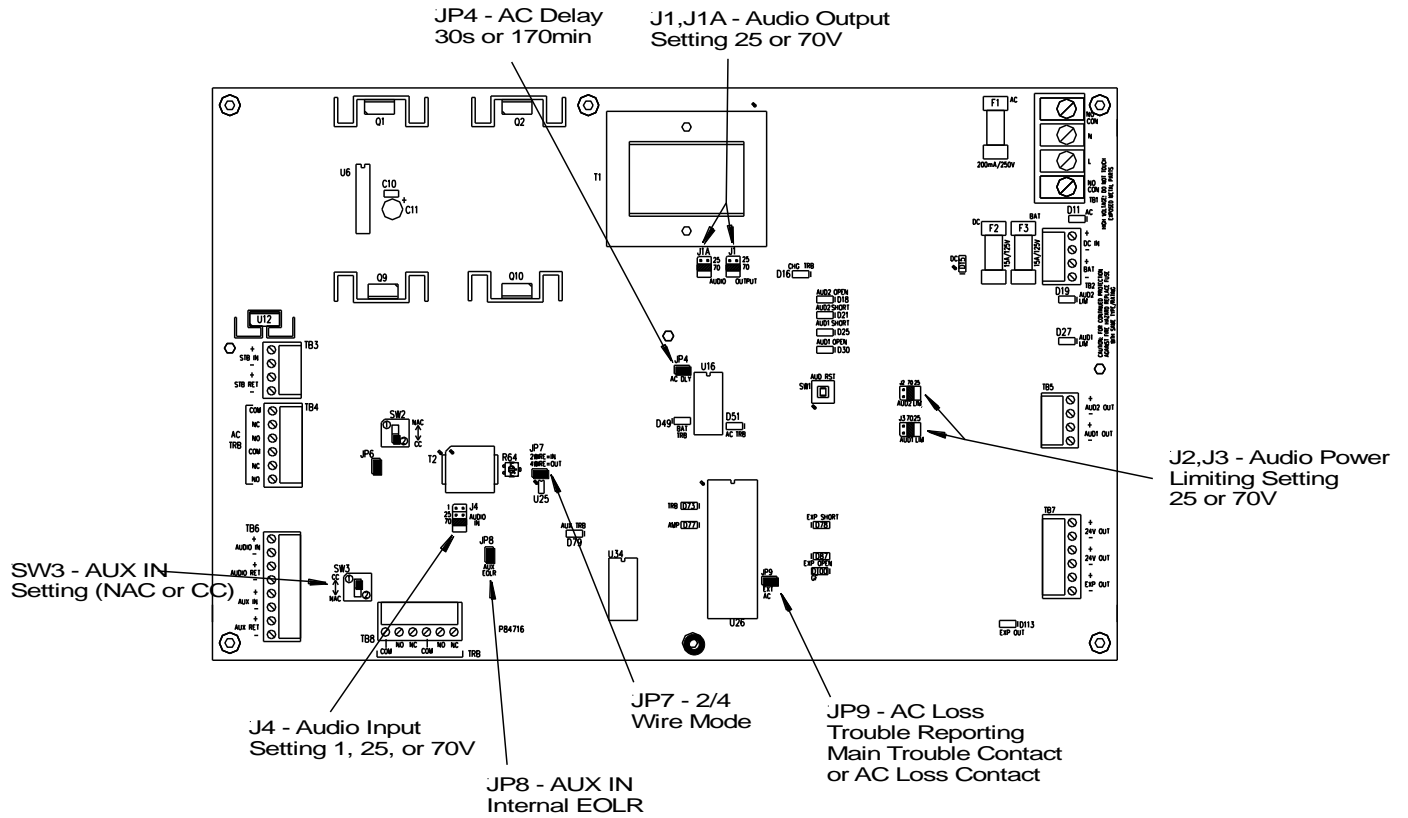

Figure 31 Jumper/Switch Locations on SPB-160 and SPB-320

Table 3 Jumper/Switch/Variable Resistor Functions

Jumpers	Name	Description
JP1	Not Used	Not Used
JP2	Not Used	Not Used
JP3	Not Used	Leave jumper in.
JP4	AC Loss Reporting Delay	<i>Jumper in place</i> – 30-second delay in reporting AC Loss trouble. <i>Jumper removed</i> – 170-minute delay in reporting AC Loss trouble.
JP5	Wheelock sync Disable (SPB-80/4 only)	<i>Jumper in place</i> – Wheelock sync enabled. <i>Jumper removed</i> – Wheelock sync disabled. Pass through sync or constant NAC enabled.
JP6	Not Used	Leave jumper in.
JP7	Two-wire or Four-Wire Mode	<i>Jumper in place</i> – Two-Wire Mode. <i>Jumper removed</i> – Four-Wire Mode.
JP8	Internal AUX RET EOLR	<i>Jumper in place</i> – Internal EOLR connected. <i>Jumper removed</i> – No Internal EOLR connected.
JP9	External AC Reporting	<i>Jumper in place</i> – AC Loss reported on main trouble contacts. Use when not reporting to off-site location. <i>Jumper removed</i> – AC Loss reported only on ACTRB contacts. Use when reporting to off-site location.
JP10	Not Used	Leave jumper in.
J1	Audio 2 Output Voltage Select	Output Voltage (25V or 70.7V).
J1A or J1B	Audio 1 Output Voltage Setting	Output Voltage (25V or 70.7 V).
J2	Audio 2 Power Limiter Setting	Set to the same setting as J1.
J3	Audio 1 Power Limiter Setting	Set to the same setting as J1A/J1B.
J4 **	Audio Input Setting	Input Voltage (1V, 25V, or 70.7V).
Switches	Name	Description
SW1	Not Used	Not Used
SW2	Strobe In NAC/CC Select (SP80/2 Only)	Selects strobe input type 8-33VDC regulated NAC or Contact Closure (CC). Switch depressed to the bottom for CC.
SW3	Auxiliary In NAC/CC Select	Selects auxiliary input type 8-33VDC NAC or Contact Closure (CC). Switch depressed to the top for CC.
SW4	Not Used	Not Used
Variable Resistors	Name	Description
R64 (LVL)	Audio Input Volume Control	Adjusts audio input volume.

** The default jumper setting for J4 audio input is 70 volts. Only use the 1 volt setting when wiring the SP4-RMX module. Failure to do so can cause damage to the motherboard.

4.6.2 Checkout Procedure

Connect AC power, and then connect batteries.

NOTE: When the AC power source is applied to the panel, the battery voltage check circuitry is activated. If batteries are not connected within 20 seconds, the panel trouble circuit activates. The battery voltage check circuitry re-checks for batteries every two minutes. If the batteries are installed during the two-minute period, the panel remains in trouble until the next re-check.

D11 AC LED (Green) should be “ON” to indicate normal operation.

If D73 TROUBLE LED (Yellow) is “ON,” a trouble condition is indicated. STOP TESTING. Refer to Chapter 8 of this manual, then troubleshoot and correct the problem before you resume testing. See Figure 34 and Figure 35 for location of LEDs.

Perform the following tests:

4.6.2.A Strobe Circuit Test (SPB-80/4 Only)

1. Switch SW2 to the CC position (depressed to the bottom).
2. Short the STB IN terminals. The Strobe Output Circuit should flash. Red LEDs D70 STB1 OUT and D57 STB2 OUT are lighted. Remove the short.

4.6.2.B Audio Output Test

Play a digital message or use the built-in microphone on the SP40S (OR SPMNS) voice evacuation panel and test the audio output circuit(s).

 **WARNING: Perform mandatory testing of all protective signaling systems as required. Test all protective signaling system equipment using qualified personnel at least twice a year for proper operation, or more often if required by codes, regulations and laws. Failure to maintain and test protective signaling system equipment can result in not detecting equipment failure that can cause serious personal injury or death to you and/or others during an emergency situation.**

4.7 Ground Fault Detection

Ground fault detection sensitivity is 600K Ohms for Class B, Style Y connections.

NOTE: The Ground Fault LED D34 may flicker while STB-IN is operated in Cooper Wheelock Pass-Through Mode (JP5 removed). This DOES NOT indicate the presence of an actual Ground Fault Trouble.

4.8 Battery Care and Backup Battery Calculations

4.8.1 Caring for Sealed Lead Acid Batteries

Sealed lead acid batteries are designed to operate in standby service for approximately five years. This is based upon a normal service condition where there is an ambient temperature of 20 degrees C (68 degrees F) and batteries are completely discharged once every three months.

Length of service life is directly affected by the number of discharge cycles, depth of discharge, and ambient temperature.

Use Guidelines

Avoid installation and/or operation in close proximity to heat sources. While the operating temperature range is 0 to 49 degrees C (32-120 degrees F), battery life is maximized at an ambient temperature of 20 degrees C (68 degrees F).

Batteries may generate ignitable gases. Because of this, install batteries in a well-ventilated location, away from spark producing equipment.

DO NOT install batteries in an atmosphere where organic solvents or adhesives may be present. DO NOT clean the batteries with oils, thinners, or similar substances. The case and cover of the batteries are ABS plastic resin, which may suffer damage from these chemicals.

DO NOT install batteries in a heavy vibration or shock location.

ALWAYS wear insulated gloves when handling batteries.

DO NOT use together batteries of different capacities, age, or manufacture.

 **WARNING: DO NOT crush, incinerate, or dismantle batteries. The electrolyte contains sulfuric acid, which can cause serious damage to eyes and skin. If contact does occur, flush with water and seek immediate medical attention.**

4.8.2 Storing Batteries

For batteries that are to be stored for an extended period of time, give a supplement charge monthly.

NEVER store batteries in a discharged condition.

The self-discharge rate of batteries is approximately 3% per month when the storage temperature is maintained at 20 degrees C (68 degrees F). The self-discharge rate varies depending upon temperature. Cooler temperatures cause the self-discharge rate to decrease. Warmer temperatures cause the self-discharge rate to increase.

4.8.3 Calculating Backup Battery Requirements

A Worksheet for assisting in calculating batteries is available in Chapter 11.

Due to the current drain on the battery, the maximum battery size for the Series SPB Audio Booster SPB-80/4 and SPB-160 is 33Ah. For the SPB-320, each SPB-160 has its own backup batteries. The enclosure can accommodate up to 12Ah. Larger batteries may necessitate a separate battery box.

It is necessary to calculate the current draw for batteries requirement. The current requirement depends on the system configuration and the appliances connected to the speaker output circuits. Batteries current has two separate calculations that are added together: Standby Current and Alarm Current.

4.8.3.A Standby Current

The standby current consumes the largest part of the storage battery capacity. The standby current of the Series Audio Booster panel is 0.120 Amps.

1. If splitters are used, calculate the amount of standby current used by the splitters and add it to the Audio Booster's standby current.
2. Multiply this value by the number of standby hours required. Normally this is 24 hours. This represents the total Standby Capacity Required in Amp-Hours for the panel.

4.8.3.B Alarm Current

The maximum alarm current for the Series SPB Booster panel is 10.1 Amps (9.6 Amps for audio, 0.50 Amps for auxiliary power).

1. Calculate strobe output current by adding the current draw of all strobes. Current draw is in Amps.
2. Calculate speaker output current by totaling all the speaker wattage settings. Multiply the sum by 0.054. The result is the current draw in Amps.
3. Add the strobe current, the speaker current, and auxiliary current together. The result is the total alarm current in Amps.
4. To operate for 5 minutes of alarm on battery power, multiply Step 2 by 0.083 hrs. To operate for 30 minutes of alarm on battery power, multiply Step 3 by 0.5 hrs. The result is the total alarm Capacity Required in Amp-Hours.

4.8.3.C Battery Calculations

Good engineering practices recommend the total Amp-hours required for backup should not exceed 90% of the Backup Battery capacity. The Audio Booster has been UL approved for up to 33Ah batteries.

1. Add the total Standby Capacity Required to the total Alarm Capacity Required.
2. Multiply Step 1 by 1.1. This is the minimum Backup Battery requirement for this panel.
3. Record results on worksheet.

4.9 Installing AC Power and Batteries

NOTE: Power-limited and non-power limited wiring **must** be separated.

 **WARNING:** Two different sources of power may be connected to this unit (SPB-80/4 and SPB-160); for the SPB-320, each module uses two different sources of power. Disconnect both sources of power before servicing. Failure to disconnect both power sources before servicing could result in serious injury or death to you and/or others.



CAUTION: Observe correct polarity requirements on all connections. Failure to do so may damage the equipment.



CAUTION: Always apply AC voltage before applying batteries voltage. Failure to do so may cause damage to the Series SPB Audio Booster panel.

4.9.1 Installing AC Power

NOTE: Power limited and non-power limited wiring **must** be separated by a minimum of 1/4".

1. For the SPB-80/4 and SPB-160, refer to Figure 25 and Figure 26, and connect the line and neutral 120VAC input wiring to the L (Line) and N (Neutral) terminals on the power supply module (SPBPS).
2. Connect the ground input wiring to the grounding terminal block on the right side of the chassis.

4.9.2 Installing Batteries

NOTE: Batteries are not supplied with this panel and must be purchased separately.

4.9.2.A Installing Batteries on the SPB-80/4 and SPB-160

Connect the supplied red battery wire to the (+) terminal and the supplied black battery wire to the (-) terminal of TB2 (BATTERY) connection.

4.9.2.B Installing Batteries on the SPB-320

NOTE: Batteries are not supplied with this panel and must be purchased separately.

The SPB-320 requires four 12V batteries UL rated up to 33Ah. The enclosure can accommodate up to 12Ah batteries. Two are wired in series to each SPB-160 module.

Run the battery wiring across the top of each power supply (SPBPS) and down the right side of the power supplies to the batteries.

Figure 32 shows the correct setup of the batteries inside the cabinet, the location of the jumper wires used to connect two batteries in series, and the location of the battery terminal connections.

Figure 33 shows the correct wiring path for the battery wiring.

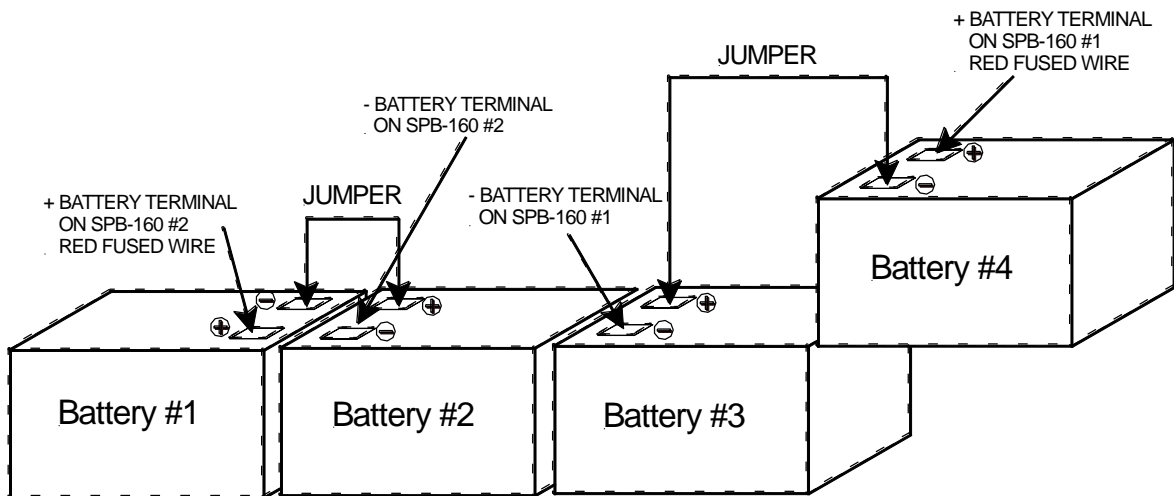

Figure 32 Battery Configuration and Wiring (SPB-320 only)

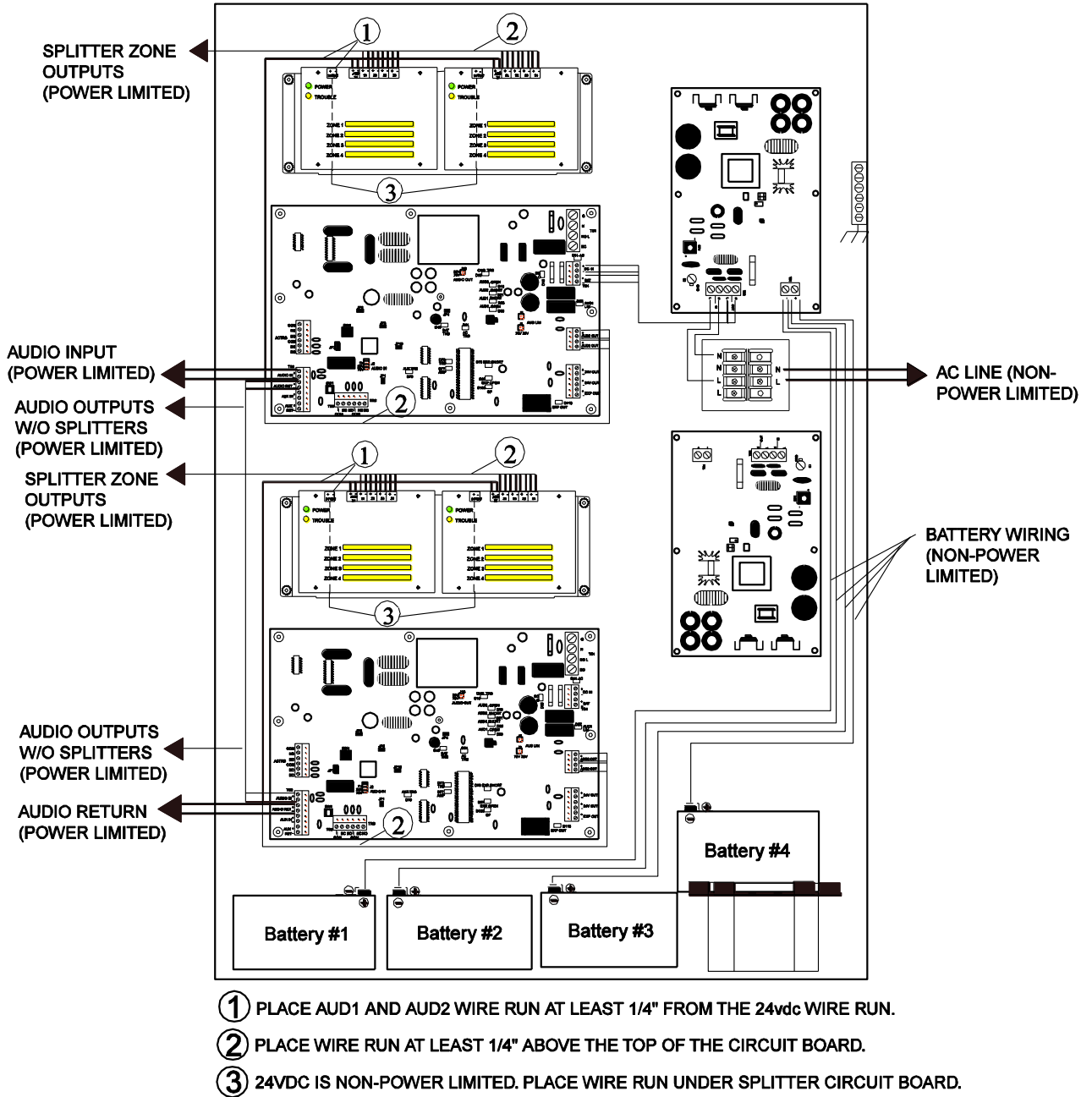

Figure 33 Proper Wiring for SPB-320 with and without SPLITTERS

1. Orient batteries #1 and #2 so that the terminals of battery #1 are on the right side of the battery and the terminals of battery #2 are on the left (See Figure 32). Connect the short YELLOW jumper between battery #1 negative (-) terminal and battery #2 positive (+) terminal.
2. Place batteries #1 and #2 inside the SPB-320 enclosure, and to the left side with the yellow jumper to the back of the enclosure (Figure 32).
3. Place battery #3 with its terminals on the left and place the battery to the right of battery #2. Attach the long YELLOW jumper to the positive (+) terminal.
4. Orient battery #4 with the terminals on the left side. Attach the other end of the long YELLOW jumper to the Negative (-) terminal. Slide the battery in its place.
5. Attach the supplied RED fused battery wire to the (+) terminal and the supplied BLACK battery wire to the (-) terminal of TB2 (BATTERY) connection on SPB-160 Module #1 and run the wire as shown in Figure 32. Attach the red wire to the positive terminal of battery #4. Do not attach the black or negative wire.



WARNING: Do not attach the black or negative wire until AC power has been applied to the SPB panel.

6. Attach the second supplied fused RED battery wire to the (+) terminal and the supplied BLACK battery wire to the (-) terminal of TB2 (BATTERY) connection on SPB-160 Module #2 and run the wire as shown in Figure 32. Attach the fused RED wire to the positive terminal of battery #1. Do not attach the BLACK or negative wire.

This page is left blank intentionally.

5 Operation

5.1 Introduction

This chapter describes the operating characteristics of the Series SPB Audio Booster Panel. Included is information about the following panel features:

Supervision

Audio Notification Appliance Output Circuit Supervision

Amplifier Supervision

Actions that Initiate Alarms

5.2 Supervision

A TROUBLE LED indicates that the supervisory functions have detected a malfunction in the panel. When a trouble condition is detected, the panel may not be able to receive and/or broadcast messages from the host voice evacuation panel.

If a trouble condition is detected by any of the supervisory functions, the internal sounder of the SP40S (OR SPMNS) voice evacuation panel operates, the audio booster Form "C" TROUBLE relay (normally energized) changes state, and the yellow TROUBLE LED turns "ON." The Trouble Status Relay may be used to provide an external audible or visual alert to indicate that the audio booster is in a trouble condition. At the same time, one of the yellow trouble location LEDs identifies the location of the trouble condition. If a trouble condition is indicated, follow the procedures in Chapter 8 "Troubleshooting."

⚠ WARNING: Do not leave the panel in a trouble condition, as it may not play warning messages from the voice evacuation panel, which could result in serious injury or death to you and/or others. If the panel indicates a trouble condition: (1) provide UL required alternative signaling and (2) have qualified service persons immediately replace unit(s) that have malfunctioned.

⚠ WARNING: Messages requested before and during a trouble condition may not be heard, which could result in serious injury or death to you and/or others. If messages requested before and during a trouble condition are still necessary, they should be repeated when the panel is returned to normal.

5.1.1 Audio Notification Appliance Output Circuit Supervision

The SPB-80/4 has one 80-watt circuit, while the SPB-160 has two 80-watt circuits. The SPB-320 has four 80-watt circuits. The audio notification appliance output circuit uses Class B, Style Y wiring, and is supervised for open and short circuits. Output circuit supervision requires installation of UL Listed 10K Ohm, 1/2W EOLR on the output circuit. A sensed open circuit trouble will illuminate D18 for AUD2 and D30 for AUD1 audio open LED. See Figure 34 and Figure 35 for LED location.

5.1.2 Visual Notification Appliance Output Circuit Supervision (SPB-80/4 only)

The SPB-80/4 has two 2-amp visual notifications circuits. The visual notification appliance output circuit on the SPB-80/4 uses Class B, Style Y wiring, and is supervised for open and short circuits. Output circuit supervision requires installation of UL Listed 10K Ohm, 1/2W EOLR on the output circuit. A sensed strobe open circuit trouble illuminates D53 for STB1, D69 for STB2. See Figure 34.

5.1.3 Amplifier Supervision

A supervisory tone plays through the amplifier section during standby for supervision purpose. Any sensed trouble illuminates D77 “AMP” LED indicator. See Figure 35 for the SPB-160 for LED indicator location.

5.1.4 Ground Fault Supervision

The panel supervises for ground fault conditions on Class B, Style Y field wiring that is not electrically isolated. The supervised wiring includes contact inputs and audio NAC circuit outputs. All other wiring is electrically isolated. If a ground fault condition exists, D100 GF LED indicator illuminates. See Figure 34 and Figure 35 for LED indicator location.

5.2 Actions that Initiate Alarms

A 1V, 25V, or 70.7V input from a voice evacuation panel initiates the voice output. On the SPB-80/4, a selection of either an 8-33 VDC NAC input or a contact closure connected to the strobe input activates the two 24VDC, 2A strobe output circuits.

6 Operational Procedures

The Series SPB Audio Boosters do not have specific operating instructions. When the Audio Booster is properly connected to the voice evacuation panel, it automatically functions properly unless there is a trouble condition. Under normal operation, the green AC LED indicator (D11) is ON, and the yellow TROUBLE LED indicator (D73) is OFF.

- The TROUBLE and AC LED indicators identify the condition of the Series SPB Audio Booster. The yellow TROUBLE LED indicator is ON whenever there is a trouble detected by the panel. If no troubles are detected, the green AC LED indicator is ON.

This page is left blank intentionally.

7 Periodic Testing and Maintenance

7.1 Introduction

- Conduct periodic testing and maintenance of the panel and all notification equipment frequently as required.
- Check local, state and federal codes, regulations and laws, for required tests.
- Make sure that only qualified personnel perform all tests and maintenance.

7.2 Periodic Testing

7.2.1 Test Frequency

- Perform mandatory testing of equipment at least twice each year, or more often as required by local, state and federal codes, regulations and laws.

7.2.2 Equipment

The following equipment needs to be tested to ensure that equipment is operating properly:

Series SPB Audio Booster

All notification appliances

7.3 Faulty Equipment

1. If the notification equipment is not working properly, contact the service representative and have problems corrected immediately.
2. If the service representative is not available, contact the manufacturer.
3. Replace any malfunctioning modules in the panel immediately. Do not attempt to repair them.
4. Return any malfunctioning modules to the manufacturer for repair or replacement.

7.4 Qualified Personnel

“Qualified personnel” are those who can evaluate proper equipment functionality and ensure its proper operation and perform all testing procedures on the panel.

 **WARNING: Provide alternative signaling means during periodic testing to assure adequate protection of people and property. Failure to provide alternative signaling may cause people to not be warned of an emergency condition which could result in serious injury or death to you and/or others.**

8 Troubleshooting

8.1 Introduction

 **WARNING:** Some electronic components store a high voltage charge, even though power is not connected, and can cause a dangerous shock if touched. Do not touch exposed circuitry on the Series SPB Audio Booster panel unless the circuitry has discharged for one hour and a safe discharge procedure is used.



CAUTION: Make sure that only qualified personnel in accordance with the procedures in this manual conduct troubleshooting and servicing. Do not attempt to make other adjustments, modifications, or repairs. Never use water, steam, cleaning liquids or sprays on the panel.



CAUTION: User servicing of the panel is limited to field-wiring changes, PC board replacement, and following the instructions in the Installation chapter (Chapter 4) and troubleshooting procedures in this chapter.

- After any troubleshooting procedure is completed, perform a complete system checkout as described in section 4.6.

8.2 Troubleshooting

The panel monitors system integrity. Items monitored for integrity are:

Visual appliance circuit field wiring (SPB-80/4)

Audio appliance circuit field wiring

Input voltage AC (120VAC, 50-60 Hz), Backup Battery (24VDC)

Battery voltage level

Battery circuit field wiring

Amplifier functionality

Battery Charge Voltage

System status is indicated to the operator via the audio supervision circuits on the voice evacuation panel, and the AC and TROUBLE LED indicators and the Trouble Form “C” relay contacts on the Series SPB Audio Booster. If a trouble condition is detected, the voice evacuation panel indicates a “short” condition on the audio or visual output circuit.

When there are no trouble conditions detected on the Series SPB Audio Booster, the AC LED and DC LED indicator always remains ON and the TROUBLE LED indicator always remains OFF.

When a trouble condition is detected, the AC LED indicator remains ON and the TROUBLE LED indicator always remains ON.

Figure 34 and Figure 35 show the location of all trouble location LED indicators within the Series SPB Audio Booster panels. Table 4 cross-references the trouble location LED indicators on the mother board to the proper troubleshooting procedure.

NOTE: When D73 TBL LED indicator is ON, indicating a panel Trouble, at least one of the other yellow LED indicators is also ON, indicating the trouble location.

Table 4 Trouble LED Procedure Cross Reference

D73 LED (Yellow)	Trouble Description	Troubleshooting Procedure
D73	Main Trouble Indicator	-----
D11 AC LED "OFF"	No DC Power to the mother Board from the Power Supply (SPBPS).	Procedure A (section 8.2.1)
D49 BAT TRB	Battery voltage is below 18.5 VDC or battery is missing.	Procedure B (section 8.2.2)
D51 AC TRB	AC power input voltage missing from TB1.	Procedure C (section 8.2.3)
D79 AUX TRB	External 1/2W EOLR missing when Jumper JP8 is removed.	Procedure D, (section 8.2.4)
D77 AMP TRB	Amplifier failure or jumpers J1 and J1A (SPB160) or J1B (SPB-80/4) are not installed incorrectly.	Procedure E (section 8.2.5)
D78 EXP SHORT	Expansion Circuit is Shorted	Procedure F (section 8.2.6)
D87 EXP OPEN	Expansion Circuit is Open	Procedure G (section 8.2.7)
D100GF	Ground Fault Trouble	Procedure H (section 8.2.8)
D25 AUD1 SHORT	Audio 1 Notification Appliance Circuit is Shorted	Procedure I (section 8.2.9)
D30 AUD1 OPEN	Audio 1 Notification Appliance Circuit is open	Procedure J (section 8.2.10)
D21 AUD2 SHORT	Audio 2 Notification Appliance Circuit is Shorted. (SPB-160 Only)	Procedure K (section 8.2.11)
D18 AUD2 OPEN	Audio 2 Notification Appliance Circuit is open. (SPB-160 Only)	Procedure L (section 8.2.12)
D56 STRB1 SHORT	Strobe Notification Appliance Circuit is shorted. (SPB-80/4 Only)	Procedure M (section 8.2.13)
D53 STRB1 OPEN	Strobe Notification Appliance Circuit is open. (SPB-80/4 Only)	Procedure N (section 8.2.14)
D67 STRB2 SHORT	Strobe Notification Appliance Circuit is shorted. (SPB-80/4 Only)	Procedure O (section 8.2.15)
D69 STRB2 OPEN	Strobe Notification Appliance Circuit is open. (SPB-80/4 Only)	Procedure P (section 8.2.16)

Before performing any of the following troubleshooting procedures, make sure that you read, understand, and follow the preliminary troubleshooting information at the beginning of this “troubleshooting” chapter.

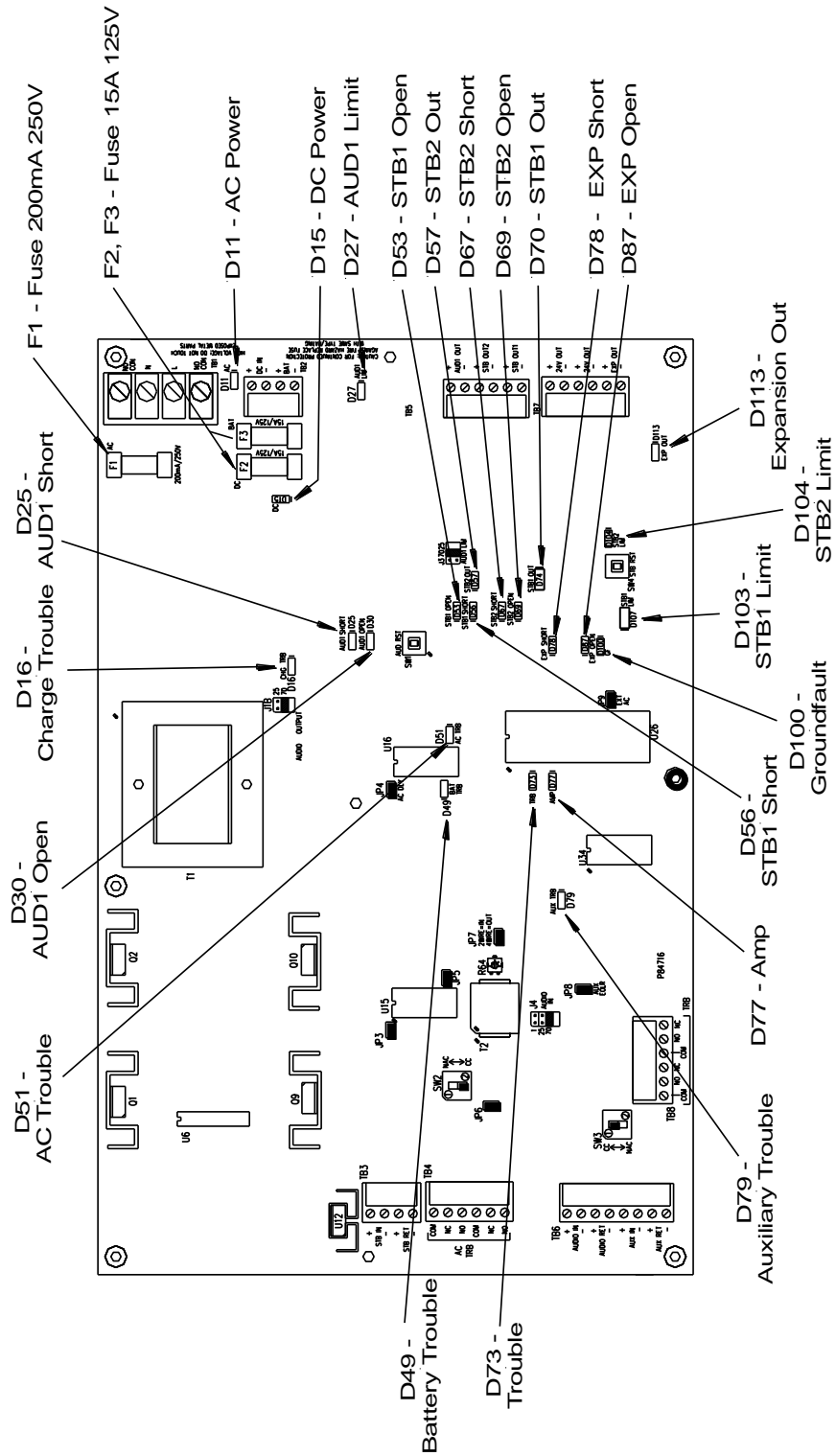

Figure 34 SPB-80/4 LED Locations

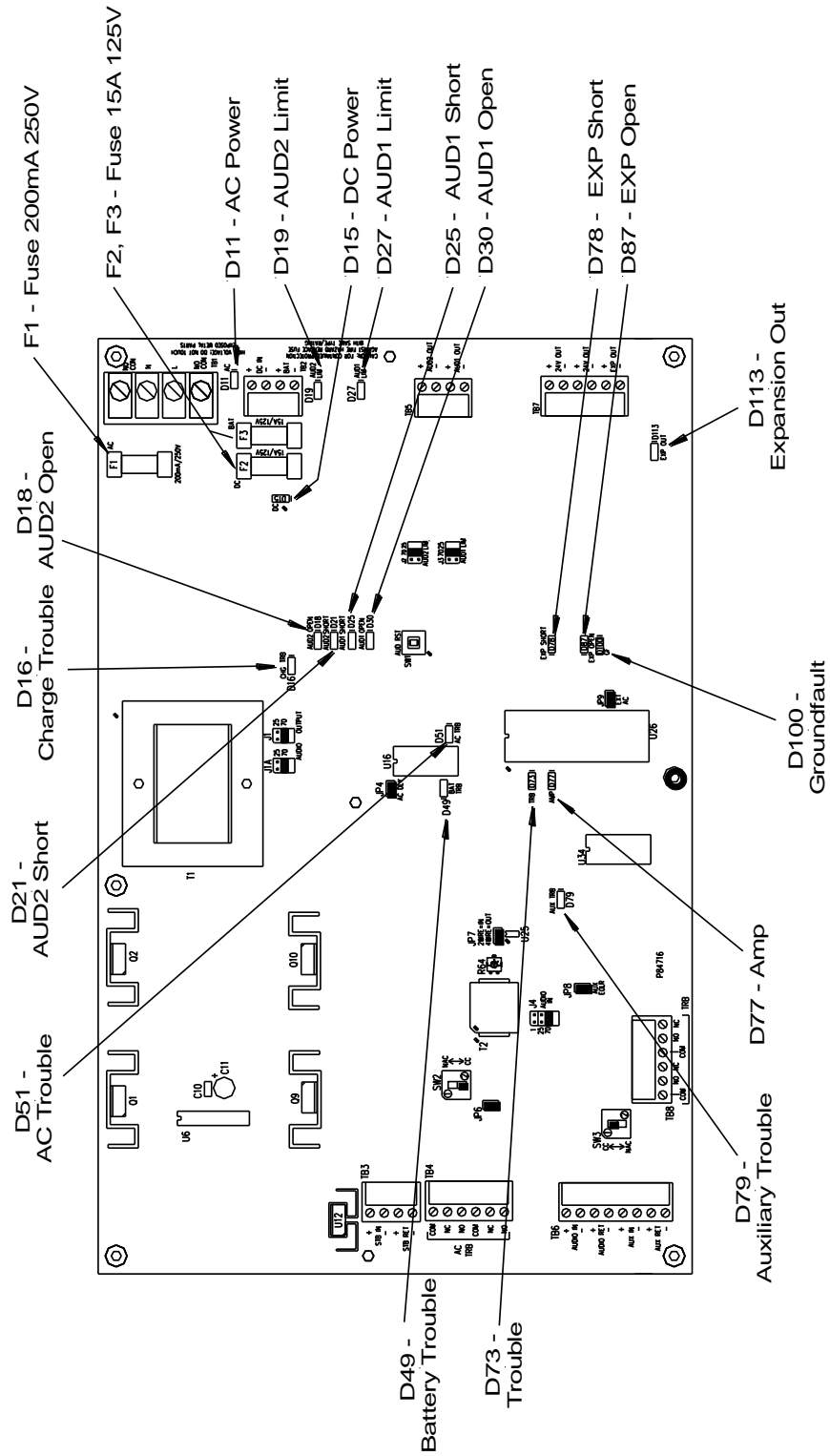

Figure 35 SPB-160 and SPB-320 LED Locations

8.2.1 Procedure A

If the green AC LED is “OFF” and all other LEDs are “OFF,” a power loss condition has occurred. A power loss condition may be caused by:

Loss of AC input voltage and battery back-up voltage.

Faulty internal wiring between the power supply module (SPBPS) and the \pm DC IN (TB4) on the mother board and batteries missing.

Faulty mother board.

Faulty Power Supply Module (SPBPS).

Perform the following:

1. Check for 24 VDC at TB2 on the mother board. Check for battery installation.
2. Check AC fuse F1.
3. If the 27VDC is present on TB2, replace the mother board.

NOTE: Mark all wires before removing components. When the trouble is repaired and before testing, replace all wires to the proper locations and replace all covers.

8.2.2 Procedure B

If the green AC LED is “ON,” the yellow TROUBLE LED is “ON,” and D49, BAT TRB LED is “ON,” Battery Voltage is below 20.4 VDC or battery is missing. A battery trouble condition might be caused by:

1. Batteries are missing.
2. Battery wiring is incorrect.
3. Batteries are defective.
4. Battery charging section of mother board is inoperable.

Perform the following:

1. Check battery compartment for the presence of batteries. If batteries are not installed, install them.
2. Ensure that the batteries are properly wired.
3. If Steps 1 and 2 are satisfied, replace the batteries.
4. Check for 24VDC at \pm BATTERY connection at TB2 on the mother board. If the voltage is below 20.4 VDC, battery-charging section of the motherboard is inoperable. Replace the motherboard (SPB-160 / SPB-80/4).

8.2.3 Procedure C

If the green AC LED is “OFF,” the yellow TROUBLE LED is “ON,” and D51, AC TRB LED is “ON,” the AC sensing circuit connected to TB1 is not operating. An AC trouble condition might be caused by:

AC input missing or low.

No AC voltage to the AC Monitor Circuit

Faulty internal wiring between the rectifier module and TB1 on the motherboard.

A faulty mother board.

Perform the following:

1. Check AC input.
2. Check fuse F1 on the mother board.
3. Check AC wiring between the power supply module (SPBPS) and TB1 on the mother board.
4. If voltage is present, replace the PC board.

8.2.4 Procedure D

If the green AC LED is “ON,” the yellow TROUBLE LED is “ON,” and D79, AUX TRB LED is “ON,” the 1/2W EOLR is missing from the AUX RET terminals when jumper JP8 is removed. An Auxiliary Trouble condition might be caused by:

Jumper JP8 removed and no 1/2W EOLR on the AUX RET terminals.

A faulty motherboard.

Perform the following:

1. If the internal 10K Ohm resistor is desired, replace the jumper JP8.
2. If a value other than 10K Ohms is desired for a 1/2W EOLR, install the 1/2W EOLR on the AUX RET terminals.
3. Replace the motherboard.

8.2.5 Procedure E

If the green AC LED is “ON,” the yellow TROUBLE LED is “ON” and the D77 AMP TRB LED is “ON,” Then the amplifier section is defective. An amplifier trouble condition may be caused by:

Missing jumpers on J1 or J1A on the SPB-160 or J1B on the SPB-80/4.

Defective amplifier

Amplifier Supervision tone missing

Perform the following:

Check jumpers J1, J1A, and J1B.

Replace the Audio Booster mother board.

8.2.6 Procedure F

If the green AC LED is “ON,” the yellow TROUBLE LED is “ON,” D78 EXP SHORT LED is “ON,” the supervision circuit is unable to read the 1/2W EOLR. This can be caused by:

Expansion circuit is shortened.

Perform the following:

Check the wiring to EXP OUT and ensure there is no short.

8.2.7 Procedure G

If the green AC LED is “ON,” the yellow TROUBLE LED is “ON,” and D87 EXP OPEN LED is “ON,” the supervision circuit is unable to read the 1/2W EOLR: This can be caused by:

Missing or Improper 1/2W EOLR.

Open or loose wiring on the EXP OUT terminals.

Open EXP OUT appliance circuit.

Perform the following:

1. Check that 1/2W EOLR is in place and is UL Listed 10K Ohm, 1/2W resistor.
2. Check the wiring to EXP OUT terminals and ensure there is no open circuit.
3. Troubleshoot the expansion circuit for incorrect wiring.

8.2.8 Procedure H

If the green AC LED is “ON,” the yellow TROUBLE LED is “ON,” and D100, GF LED is “ON,” a ground fault condition exists on the output wiring. A GF trouble condition might be caused by:

Appliance wiring touching conduit.

Improper Installation of an appliance(s).

Perform the following:

1. Disconnect appliances from the strobe and speaker connection on the motherboard.
2. Troubleshoot NAC circuits by checking for a resistance reading other than infinity between the appliance leads and the conduit.

8.2.9 Procedure I

If the green AC LED is “ON,” the yellow TROUBLE LED is “ON,” and D25 AUD1 SHORT LED is “ON,” the supervision circuit is unable to read the 1/2W EOLR: This can be caused by:

Audio appliance connected is shorted.

Shorted connection on the AUD1 OUT circuit.

Circuit installed improperly.

Perform the following:

1. Check wiring to AUD1 OUT terminals and ensure there is no short.
2. Troubleshoot audio circuit for incorrect wiring of an appliance or a failed appliance.

8.2.10 Procedure J

If the green AC LED is “ON,” the yellow TROUBLE LED is “ON,” and D30 AUD1 OPEN LED is “ON,” the supervision circuit is unable to read the 1/2W EOLR. This can be caused by:

Missing or Improper 1/2W EOLR.

Open or loose wiring on the AUD1 OUT terminals.

Open AUD1 OUT appliance circuit.

Perform the following:

1. Check that 1/2W EOLR is in place and is UL Listed 10K Ohm
2. Check the wiring to AUD1 OUT terminals and ensure there is no open circuit.
3. Troubleshoot the audio circuit for incorrect wiring.

8.2.11 Procedure K (SPB-160 Only)

If the green AC LED is “ON,” the yellow TROUBLE LED is “ON,” and D21 AUD2 SHORT LED is “ON,” the supervision circuit is unable to read the 1/2W EOLR. This can be caused by:

Audio appliance connected is shorted.

Shorted connection on the AUD2 OUT circuit.

Circuit installed improperly.

Perform the following:

1. Check the wiring to AUD2 OUT terminals and insure there is no short.
2. Troubleshoot the strobe circuit for incorrect wiring of an appliance or a failed appliance.

8.2.12 Procedure L (SPB-160 Only)

If the green AC LED is “ON,” the yellow TROUBLE LED is “ON,” and D18 AUD2 OPEN LED is “ON,” the supervision circuit is unable to read the 1/2W EOLR. This can be caused by:

Missing or Improper 1/2W EOLR.

Open or loose wiring on the AUD2 OUT terminals.

Open AUD2 OUT appliance circuits.

Perform the following:

1. Check that 1/2W EOLR is in place and is UL Listed 10K Ohm, 1/2W EOLR.
2. Check the wiring to AUD2 OUT terminals and insure there is no open circuit.
3. Troubleshoot the audio circuit for incorrect wiring.

8.2.13 Procedure M (SPB-80/4 Only)

If the green AC LED is “ON,” the yellow TROUBLE LED is “ON,” and D56 STRB1 SHORT LED is “ON,” the supervision circuit is unable to read the 1/2W EOLR. This can be caused by:

- Strobe appliance connected improperly or is shorted.
- Shorted connection on the STB1 OUT circuits.
- Circuit installed improperly.

Perform the following:

1. Check the wiring to STB1 OUT terminals and ensure proper polarity.
2. Troubleshoot the strobe circuit for incorrect wiring of an appliance or a failed appliance.

8.2.14 Procedure N (SPB-80/4 Only)

If the green AC LED is “ON,” the yellow TROUBLE LED is “ON,” and D69 STRB1 OPEN LED is “ON,” the supervision circuit is unable to read the 1/2W EOLR. This can be caused by:

- Missing or improper EOLR
- Open or loose wiring on the STB1 OUT terminals.
- Open STB1 OUT appliance circuit.

Perform the following:

1. Check that the 1/2W EOLR is in place is UL Listed 10k Ohm ½ EOLR.
2. Check the wiring to STB1 OUT terminals and make sure that there’s no open circuit.
3. Troubleshoot the strobe circuit for incorrect wiring.

8.2.15 Procedure O (SPB-80/4 Only)

If the green AC LED is “ON,” the yellow TROUBLE LED is “ON,” and D67 STRB2 SHORT LED is “ON,” the supervision circuit is unable to read the 1/2W EOLR. This can be caused by:

- Strobe appliance connected improperly or is shorted.
- Shorted connection on the STB2 OUT circuits.
- Circuit connection installed improperly.

Perform the following:

1. Check the wiring to STB2 OUT terminals and ensure proper polarity.
2. Troubleshoot strobe circuit for incorrect wiring of an appliance or a failed appliance.

8.2.16 Procedure P (SPB-80/4 Only)

If the green AC LED is “ON,” the yellow TROUBLE LED is “ON,” and D56 STRB2 OPEN LED is “ON,” the supervision circuit is unable to read the 1/2W EOLR. This can be caused by:

- Missing or improper EOLR
- Open or loose wiring on the STB1 OUT terminals.
- Open STB1 OUT appliance circuit.

Perform the following:

1. Check that the 1/2W EOLR is in place is UL Listed 10k Ohm ½ EOLR.
2. Check the wiring to STB1 OUT terminals and make sure that there’s no open circuit.
3. Troubleshoot the strobe circuit for incorrect wiring.

This page is left blank intentionally.

9 Technical Data

9.1 Mechanical

Parameter	SPB-80/4 and SPB-160	SPB-320
Dimensions (H x W X D)	21 x 16 x 6 inches	36 x 24 x 6 inches
Weight	36 lb.	100 lb.
Finish	Red	Red
Enclosure Construction Type	Enclosure Door 0.060" steel Enclosure Backbox 0.060" steel	Enclosure Door 0.075" steel Enclosure Backbox 0.060" steel
Mounting	Indoor surface mount	Indoor surface mount
Wiring Entry	Knockouts (3/4"-1") (20 total)	Top and side knockouts 14 – (3/4-1") and 4 – (1 1/4-1 1/2")
Door Lock	Standard Cooper Wheelock key-lock (SP-KEY)	Standard Cooper Wheelock key-lock
PC Boards	1 - Audio Booster mother Board (SPBMB-160 and SPBMB-80) 1 - 27VDC Power Supply (SPBPS)	2- SPB-160 Audio Booster mother board (SPBMB-160) 2- 27VDC Power Supply (SPBPS) 1- AC Input Terminal PC Board

9.2 Environmental

Parameter	Description
Operating Temperature	0 to 49 °C (32 to 120 °F)
Storage Temperature	-20 to 70 °C (-4 to 158 °F)
Humidity, Non-condensing	93 ± 5% at 30 ± 2 °C (86 ± 4 °F)

9.3 Electrical

9.3.1 Input

Parameter	SPB-80/4 and SPB-160	SPB-320
Input Voltage	120VAC, 3.8A, 50-60 Hz	120VAC, 7.4A, 50-60 Hz
Battery Backup	24VDC, Up to 33Ah	24VDC, Up to 33Ah

9.3.2 Battery Current Calculations

The current draw of the Series SPB Audio Booster is determined by the configuration being utilized. Section 4.8, Battery Care and Batteries Calculation, will assist you in developing the current requirements.

9.3.3 Activation Inputs

The panel audio output is activated by applying a 1V, 25V, or 70.7V to AUD IN. Power consumption is 1.2 Watts @ 70.7V and 0.25 Watts @ 25V.

The AUX IN is triggered using 8 – 33VDC at 10mA in NAC mode or with contact closure in CC mode.

9.3.4 Outputs

Parameter	Description
Visual Notification Appliance Output (SPB-80/4 only)	2 output circuits. 2.0 amps at 24VDC. Supervised.
Central Amplified Audio Output	(SPB-80/4) 1 output circuit. Selectable 25 or 70.7 Volt output at 80W max. Supervised. (SPB-160) 2 output circuits. (SPB-320) Selectable 25 or 70.7 Volt output at 80W max for each. Supervised.
Trouble Contact	Form C contact normally energized. Contacts transfer during trouble: 1.0 amp at 24VDC max, resistive load (see following warning). Non-Supervised.

⚠ WARNING: Do not exceed the ratings of the status contacts. Exceeding this rating may cause the relay to fail and prevent a trouble condition from being indicated.

9.4 Wiring Connections

Parameter	Description
Screw terminals	Accepts #12 to #18 AWG for single wire connection, or #16 to #18 AWG for double wire connection.

9.4.1 End of Line Resistor (1/2W EOLR)

Parameter	Description
Visual Notification Appliance Outputs (SPB-80/4 and SPB-160 only)	UL Listed 10K Ohm, 1/2W EOLR
Audio Notification Appliance Outputs	UL Listed 10K Ohm, 1/2W EOLR

This page is left blank intentionally.

10 Warranty

10.1 Limited Warranty

Cooper Wheelock, Inc. dba Cooper Notification and Cooper Notification, Inc. (each, a “Seller”) products must be used within their published specifications and must be PROPERLY specified, applied, installed, operated, maintained and operationally tested in accordance with these instructions at the time of installation and at least twice a year or more often and in accordance with local, state and federal codes, regulations and laws. Specification, application, installation, operation, maintenance and testing must be performed by qualified personnel for proper operation in accordance with all of the latest National Fire Protection Association (NFPA), Underwriter’s Laboratories (UL), National Electrical Code (NEC), Occupational Safety and Health Administration (OSHA), local, state, county, province, district, federal and other applicable building and fire standards, guidelines, regulations laws and codes including, but not limited to, all appendices and amendments and the requirements of the local authority having jurisdiction (AHJ). Seller products when properly specified, applied, installed, operated, maintained and operationally tested as provided above are warranted against mechanical and electrical defects for a period of (a) three (3) years from date of manufacture with respect to MEDC and Seller Industrial Signals and Seller Fire and Security Notification Appliances and Devices, or (b) one (1) year from date of manufacture with respect to Waves and SafePath Voice Evacuation and Mass Notification Systems (date of manufacture is determined by date code.) Correction of defects by repair or replacement shall be at Seller’s sole discretion and shall constitute fulfillment of all obligations under this warranty. THE FOREGOING LIMITED WARRANTY SHALL IMMEDIATELY TERMINATE IN THE EVENT ANY PART NOT FURNISHED BY SELLER IS INSTALLED IN THE PRODUCT. THE FOREGOING LIMITED WARRANTY SPECIFICALLY EXCLUDES ANY SOFTWARE REQUIRED FOR THE OPERATION OF OR INCLUDED IN A PRODUCT. SELLER MAKES NO REPRESENTATION OR WARRANTY OF ANY OTHER KIND, EXPRESS, IMPLIED OR STATUTORY WHETHER AS TO MERCHANTABILITY, FITNESS FOR A PARTICULAR PURPOSE OR ANY OTHER MATTER.

USERS ARE SOLELY RESPONSIBLE FOR DETERMINING WHETHER A PRODUCT IS SUITABLE FOR THE USER’S PURPOSES, OR WHETHER IT WILL ACHIEVE THE USER’S INTENDED RESULTS. THERE IS NO WARRANTY AGAINST DAMAGE RESULTING FROM MISAPPLIACATION, IMPROPER SPECIFICATION, ABUSE, ACCIDENT OR OTHER OPERATING CONDITIONS BEYOND SELLER’S CONTROL.

SELLER DOES NOT WARRANT THAT THE OPERATION OF THE SOFTWARE WILL BE UNINTERRUPTED OR ERROR-FREE OR THAT THE SOFTWARE WILL MEET ANY OTHER STANDARD OF PERFORMANCE, OR THAT THE FUNCTIONS OR PERFORMANCE OF THE SOFTWARE WILL MEET THE USER’S REQUIREMENTS.

SELLER SHALL NOT BE LIABLE FOR ANY DELAYS, BREAKDOWNS, INTERRUPTIONS, LOSS, DESTRUCTION, ALTERATION, OR OTHER PROBLEMS IN THE USE OF A PRODUCT ARISING OUT OF OR CAUSED BY THE SOFTWARE.

THE LIABILITY OF SELLER ARISING OUT OF THE SUPPLYING OF A PRODUCT, OR ITS USE, WHETHER ON WARRANTIES, NEGLIGENCE, OR OTHERWISE, SHALL NOT IN ANY CASE EXCEED THE COST OF CORRECTING DEFECTS AS STATED IN THE LIMITED WARRANTY AND UPON EXPIRATION OF THE WARRANTY PERIOD ALL SUCH LIABILITY SHALL TERMINATE. SELLER IS NOT LIABLE FOR LABOR COSTS INCURRED IN REMOVAL, REINSTALLATION OR REPAIR OF A PRODUCT BY ANYONE OTHER THAN SELLER OR FOR DAMAGE OF ANY TYPE WHATSOEVER, INCLUDING BUT NOT LIMITED TO, LOSS OF PROFIT OR INCIDENTAL, INDIRECT, CONSEQUENTIAL, SPECIAL, PUNITIVE OR EXEMPLARY DAMAGES. THE FOREGOING SHALL CONSTITUTE THE SOLE REMEDY OF THE PURCHASER AND THE EXCLUSIVE LIABILITY OF SELLER.

IN NO CASE WILL SELLER'S LIABILITY EXCEED THE PURCHASE PRICE PAID FOR A PRODUCT.

10.2 Limitation of Liability

SELLER'S LIABILITY ON ANY CLAIM OF ANY KIND, INCLUDING NEGLIGENCE AND BREACH OF WARRANTY, FOR ANY LOSS OR DAMAGE RESULTING FROM, ARISING OUT OF, OR CONNECTED WITH THIS CONTRACT, OR FROM THE MANUFACTURE, SALE, DELIVERY, RESALE, REPAIR OR USE OF ANY PRODUCT COVERED BY THIS ORDER SHALL BE LIMITED TO THE PRICE APPLICABLE TO THE PRODUCT OR PART THEREOF WHICH GIVES RISE TO THE CLAIM. SELLER'S LIABILITY ON ANY CLAIM OF ANY KIND SHALL CEASE IMMEDIATELY UPON THE INSTALLATION IN THE PRODUCT OF ANY PART NOT FURNISHED BY SELLER. IN NO EVENT SHALL SELLER BE LIABLE FOR ANY CLAIM OF ANY KIND UNLESS IT IS PROVEN THAT ITS PRODUCT WAS THE DIRECT CAUSE OF SUCH CLAIM. FURTHER, IN NO EVENT, INCLUDING IN THE CASE OF A CLAIM OF NEGLIGENCE, SHALL SELLER BE LIABLE FOR INCIDENTAL, INDIRECT, CONSEQUENTIAL, SPECIAL, PUNITIVE OR EXEMPLARY DAMAGES. SOME STATES DO NOT ALLOW THE EXCLUSION OR LIMITATION OF INCIDENTAL OR CONSEQUENTIAL DAMAGES, SO THE PRECEDING LIMITATION MAY NOT APPLY TO ALL PURCHASERS.

APPENDIX A

The following Cooper Notification products are LISTED compatible with the audio notification appliance output and the visual notification output circuits for the *SP40S* Panel. When connected to the SPB-80/4, strobe synchronization is system-wide. All strobe products can be fully synchronized.

Strobes

RSS-24MCW	RSS-24MCC	RSSP-24MCW
RSS-24MCWH	RSS-24MCCH	RSSP-241575W
RSS-241575W	RSS-24MCCHR	DC-MAXS
RSSWP-2475W	RSSP-24MCWH	
ZRS-MCW	LST/LST-C	
ZRS-MCWH	ST/ST-C	

Speaker/Strobe Combination

ET-1080-IS-24	ET70-24MCW	S8-25/70MCC
ET-1080-LS-24	ET70-24MCWH	S8-25/70MCCH
ET-1080-LSM-24	ET70-241575W	STH-2MSR
ET-1080-MS-24	E70-24MCW	STH-3MSR
ET-1080-SLM-24	E70-24MCCWH	STH-4MSR
E50-24MCW	E70-241575W	STH-2R24MCCH
E50-24MCWH	E70H-241575W	STH-3R24MCCH
E50-241575W	E70H-MCW	STH-4R24MCCH
E50H-241575W	E70H-24MCWH	STH-4M30WC
E50H-MCW	ET80-24MCW	STH-90-R24MCCH
E50H-24MCWH	ET80-24MCWH	LSPST/LSPST-C
E60-24MCC	ET80-241575W	
E60-24MCCH	E90-24MCC	
E60-24MCW	E90-24MCCH	
E60-24MCWH	ET90-24MCC	
E60-241575W	ET90-24MCCH	
E60H-24MCC	E90H-24MCC	
E60H-24MCCH	E90H-24MCCH	

Horns

LHN/LHN-C
HN/HN-C
LLFHN

Horn/Strobe Combination

LHS/LHS-C
HS/HS-C
LLFHS

The following Wheelock products are LISTED compatible with the trouble audible output.

Bells

MB-G6-24
MB-G10-24

The following devices are rated per UL 2017 and UL 864 for use with the SP40S and SPB amplifiers for the NFPA 72 low frequency tone sleeping area application

Speakers	Speaker/Strobes	
E50H	E50H-241575W	E50H-24MCW
E60H	E50H-24MCWH	E60H-24MCC
E70H	E60H-24MCCH	E70H-241575W
E90H	E70H-24MCW	E70H-24MCWH
S8-70/25	E90H-24MCC	E90H-24MCCH
LSPK	S8-24MCC	S8-24MCCH
LSPK-C	LSPST	LSPST-C
	Accessories	
	SP4Z-A/B	
	SP4-APS	
	SP-SVC	