

Features

- 4 / 8 / 16 Channel Analog Standalone Digital Video Recorder
- UTC AHD camera supported
- Up to 8TB HDD supported
- Mobile phone (iOS, Android) solutions provided
- P2P QR code UID connection for APP and Navigator
- Chrome, Edge, Firefox, IE, Opera, Safari supported

Product Overview

Internal Hard Drives Model Front View

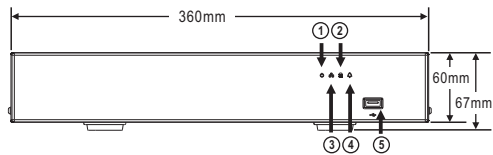

- ① Power LED, amber, lit constantly, power status indicator
- ② HDD LED, green, blinking, HDD activity indicator
- ③ LAN LED, green, blinking, network activity indicator
- ④ ALARM LED, red, blinking, alarm status indicator
- ⑤ USB port



Warning: Do not throw your product in municipal waste. This product has been designed to enable proper reuse of parts and recycling. The symbol of the crossed out wheeled bin indicates that the product (electrical and electronic equipment) should not be placed in municipal waste. Check local regulation for disposal of electronics products.

Internal Hard Drives Model Rear View

[16 Channel]

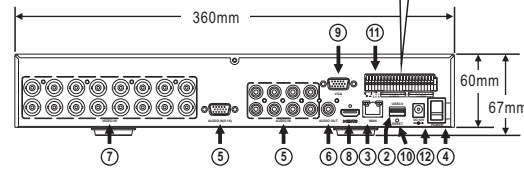
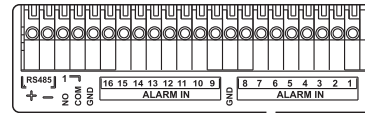

- ⑦ Video Out
- ⑧ Video input
- ⑨ HDMI output
- ⑩ VGA output
- ⑪ Power switch
- ⑫ Reset Button
- ⑬ DI/DO, RS-485 output
- ⑭ Power socket
- ⑮ Audio input
- ⑯ Audio output

Installation Instructions

Hard drives bracket

Remove the DVR top cover and loosen the screws on both sides of the hard drive bracket to take it out, install the hard drive on the bracket and secure with the included screws in the package, put the hard drive bracket back and fasten tightly. Properly attach the SATA and power cables to the connectors. Replace the DVR top cover and fasten with the screws removed previously, to complete the hard drive installation.

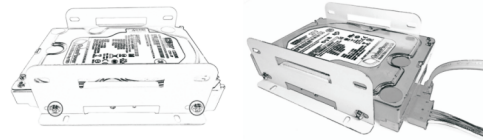

Installation Precautions

1. When installing the hard disk bracket on the base, make sure the power cable is not pressed under the hard disk:

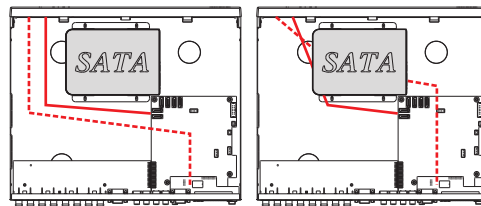

2. When installing the hard disk bracket, make sure the hard disk SATA port is facing the motherboard, to avoid hard disk reversed connection.

[16 Channel]

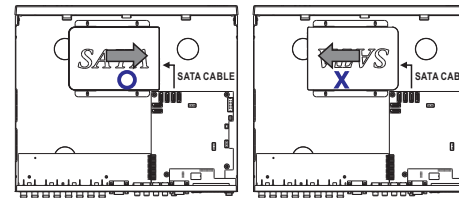

[4/8 Channel]

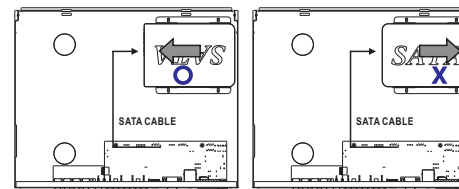

Cover

Attach the DVR top cover to the main chassis, tighten the screws on both sides and rear panel of the DVR.

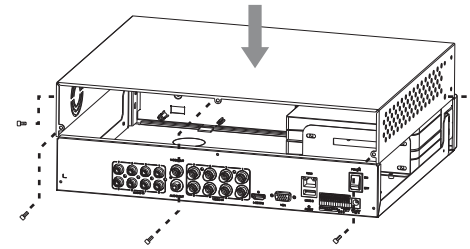

Note: The screw holes on the top cover near the front panel are located at the lower left of the four holes, and the remaining holes are for the L-bracket of the DVR cabinet.

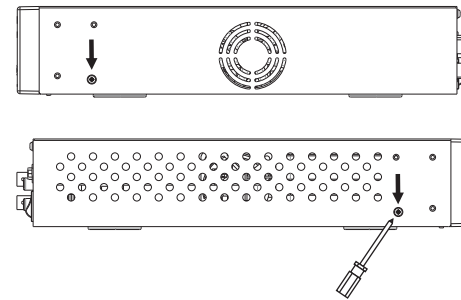

Digital Video Recorder Instructions

Please refer to below structure diagram for installation.

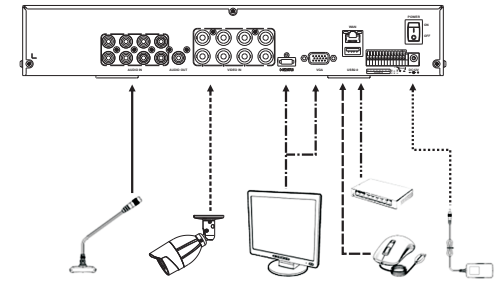

- : Adapter output to DVR power socket.
- : USB mouse to DVR USB port.
- : DVR video output (HDMI / VGA) to monitor input.
- : DVR ethernet connector to network switch.
- : Analog /AHD camera video input.
- : Audio input.

1. Plug USB mouse into DVR USB port
2. Plug adapter output into DVR power socket
3. Connect network switch, plug a network cable on DVR RJ-45 Gigabit connector, and the opposite end of the cable into network switch.
4. DVR use with DC power supply AHD camera, plug a coaxial cable on AHD camera, and the opposite end of the cable into DVR video input.
5. Plug HDMI or VGA cable on DVR, and the opposite end of the cable into monitor HDMI or VGA input.
6. After making sure all cables are properly connected, power on the DVR

Begin using the DVR

For details about DVR operation, please scan the QR code inside the package to get the operation manual.

Caution

- Do not drop or strike the equipment.
- Do not install the equipment near naked flames or heat sources.
- Do not expose this unit to rain, moisture, smoke or dusty environments.
- Do not cover the opening of the unit with cloth or plastic or install this unit in a poorly-ventilated place. Allow 10 cm between this unit and its surroundings.
- Do not continue to operate the unit under abnormal conditions such as detection of smoke, strange smell, or malfunctioned screen whilst power is turned on.
- Do not touch the power connection with wet hands.
- Do not damage the power cord or leave it under pressure.
- To avoid unnecessary magnetic interference, do not operate this unit near magnets, speaker system, etc.
- All connection cables must be grounded properly.

CAUTION

RISK OF EXPLOSION IF BATTERY IS REPLACED WITH AN INCORRECT TYPE DISPOSE OF USED BATTERIES ACCORDING TO THE INSTRUCTIONS

安裝說明

產品特色

- 4、8、16 頻道模擬高清嵌入式數位錄影機
- 支援 AHD 攝影機同軸電纜操控
- 支援 8TB 硬碟
- 行動裝置 iOS、安卓系統支援
- 行動裝置及 Navigator 點對點專用序號連線
- 多瀏覽器支援 Chrome、Edge、Firefox、IE、Opera、Safari

部件說明及尺寸

內接式硬碟機種前面板說明

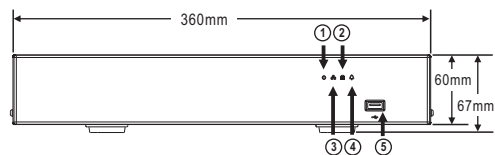

- ① 電源指示LED，橘色、長亮，顯示電源狀態
- ② 硬碟指示LED，綠色、閃爍，顯示硬碟存取
- ③ 網路指示LED，綠色、閃爍，顯示網路是否連接
- ④ 警報指示LED，紅色、閃爍，顯示警報是否觸發
- ⑤ USB 埠

[4 頻道]

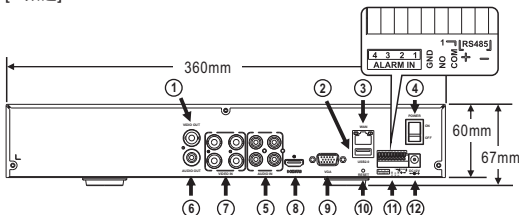

[8 頻道]

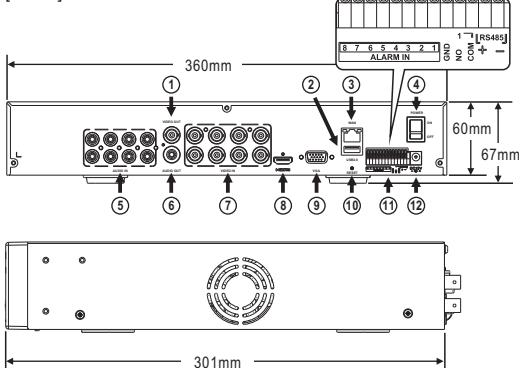

內接式硬碟機種後背板說明

[16 頻道]

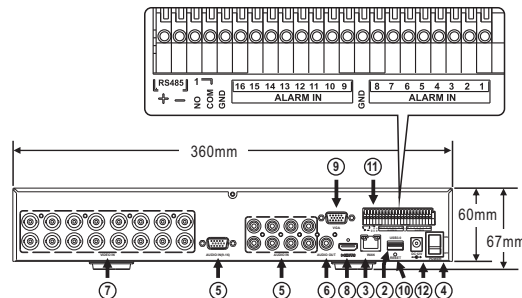

- ① 影像輸出
- ② USB 埠
- ③ RJ-45 乙太網路接口
- ④ 電源開關
- ⑤ 音源輸入
- ⑥ 音源輸出
- ⑦ 影像輸入
- ⑧ HDMI 輸出
- ⑨ VGA 輸出
- ⑩ 恢復出廠預設值
- ⑪ DI/DO, RS-485 輸出
- ⑫ 電源接頭

安裝說明

硬碟支架

卸除螺絲並移除主機殼上蓋，卸除硬碟架兩側鎖點螺絲，取下硬碟架，使用配件包中螺絲將硬碟固定於硬碟架上，並將硬碟架置回，鎖緊硬碟架兩側鎖點固定硬碟架，接上 SATA 線及電源線。

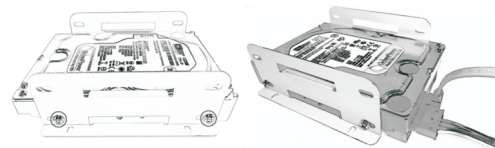

安裝注意事項

1. 安裝硬碟支架於底座時，需注意電線線材是否有壓在硬碟下方。

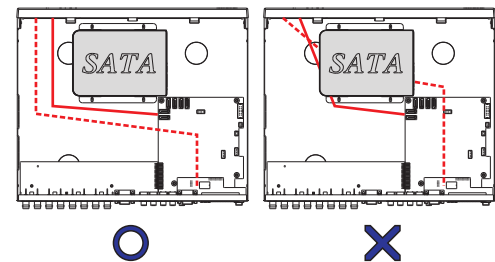

2. 安裝硬碟支架時，需注意硬碟SATA埠接口朝向主板，避免硬碟反向無法接線。

[16 頻道]

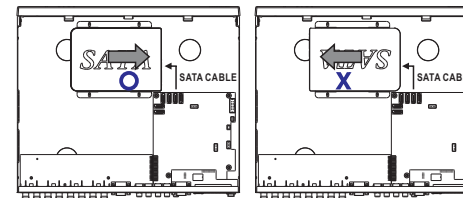

[4/8 頻道]

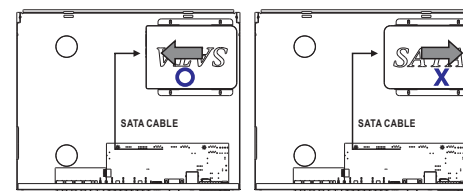

上蓋安裝

將DVR上蓋置回主機，並鎖上二側及背板螺絲。

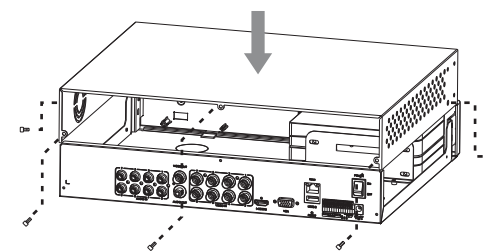

注意上蓋靠近前面板的螺絲孔位在4個孔位的左下處，其餘孔位為機櫃 L 型支架使用。

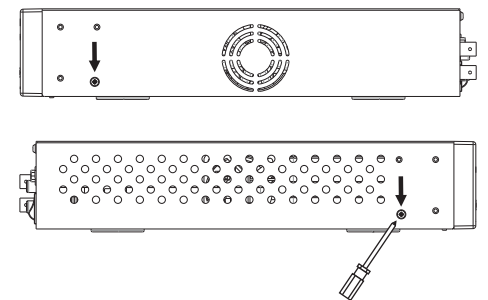

類比高清嵌入式數位錄放影機連接說明

參考下列架構連接錄放影機

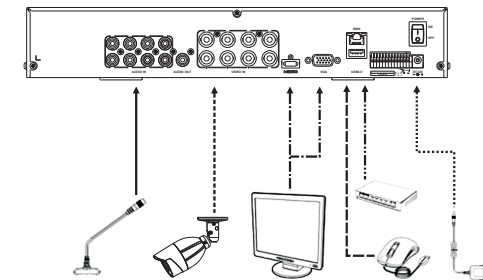

- : 變壓器至 DVR 電源接頭
- - - - : USB 滑鼠至 DVR USB 滑鼠連接埠
- - - - : DVR 影像輸出(HDMI/VGA)至螢幕輸入
- - - - : DVR/網路攝影機乙太網路接口至網路交換機
- - - - : 傳統類比/AHD 攝影機影像輸入
- : 音源輸入

1. 將 USB 滑鼠插入錄放影機的 USB 滑鼠連接埠
2. 將電源變壓器輸出或電源線接入錄放影機的電源接頭
3. 使用 RJ-45 網路線，將一端接在錄放影機的乙太網路接口，另一端接入安裝環境中的網路交換器
4. 如使用直流供電AHD類比攝影機，使用同軸電纜線，將一端接在類比攝影機的影像輸出接口，另一端接入DVR的影像輸入端
5. 使用 HDMI 或 VGA 連接線，將一端接入錄放影機的 HDMI 或 VGA 輸出埠，另一端接入螢幕的輸入埠
6. 確認上述項目都已妥善連接後開啟錄放影機電源

開始使用類比高清嵌入式數位錄放影機

關於錄放影機的使用請掃描包裝中所附 QR 圖碼(QR Code)，取得完整的說明。

注意事項

- 請勿摔落或敲打設備
- 請勿將設備安裝於火源或熱源附近
- 請勿將設備暴露於雨水、高濕度、煙霧、及高落塵的環境中
- 請勿將設備換氣孔以衣物或任何物品遮蔽，或將設備安裝於通風不良的環境中，請在設備周圍保留 10 公分的間隙
- 請立即關閉設備電源當發現有煙霧、異味、螢幕無訊號及其他異常狀況
- 操作時請保持乾燥
- 請勿凹折或重壓電源線
- 請勿將設備置遠離高磁性物體，避免不必要的干擾，如磁鐵、或高功率喇叭等等
- 請將所有連接線材妥善接地

注意

若使用錯誤的電池會有爆炸的危險，請依照指示處理廢棄的電池