

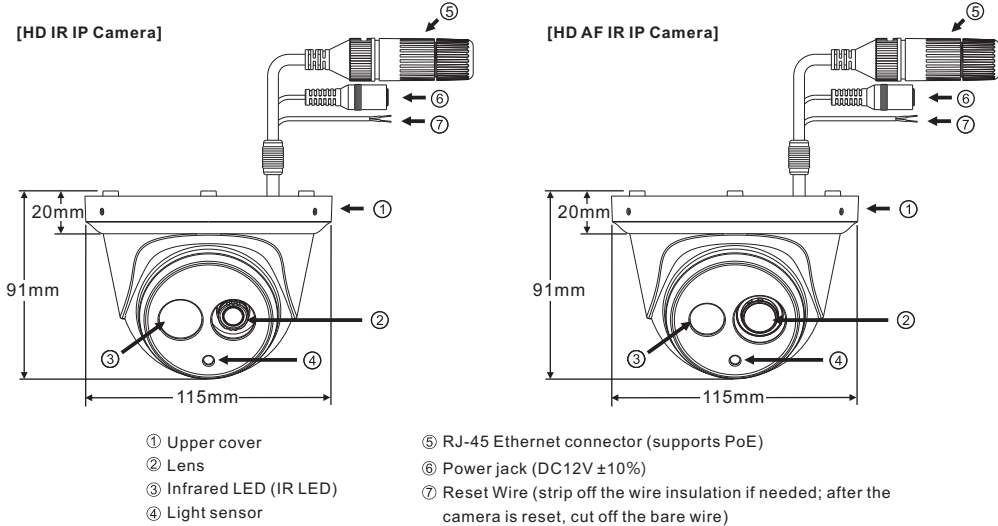

Warning: Do not throw your product in municipal waste. This product has been designed to enable proper reuse of parts and recycling. The symbol of the crossed out wheeled bin indicates that the product (electrical and electronic equipment) should not be placed in municipal waste. Check local regulation for disposal of electronics products.

### Part Description & Dimensions



### Installation

- Retrieve the camera and remove the bottom bracket from the upper cover with a hex key (FIG.1).  
 Note: For outdoor installation, it is recommended to install a waterproof junction box.

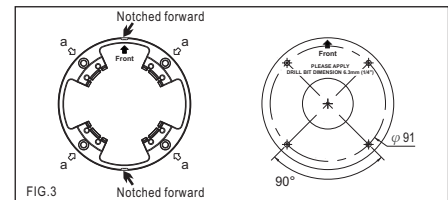
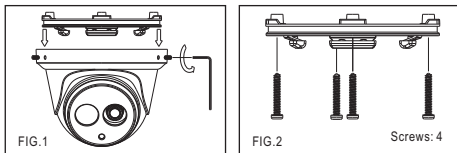

- Attach the Ethernet and power cables to the RJ-45 connector and the DC-in connector, respectively (FIG.4).

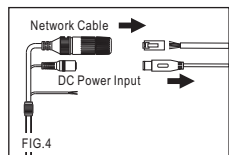

- Connect the RJ-45 Ethernet cable with a waterproof connector. First, remove the waterproof connector and unscrew the waterproof nut. Insert the Ethernet cable and connect to the RJ-45 connector with proper tools (FIG.5). Then, tighten the waterproof connector and nut before the RJ-45 connector is connected to the camera (FIG.6).

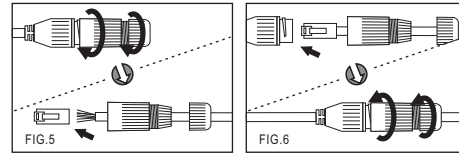

- Align the hole on the left side of the upper cover with the notch on the bottom bracket, press in and rotate to the desired location (FIG. 7). Secure the upper cover to the bottom bracket with a hex key (FIG.8).

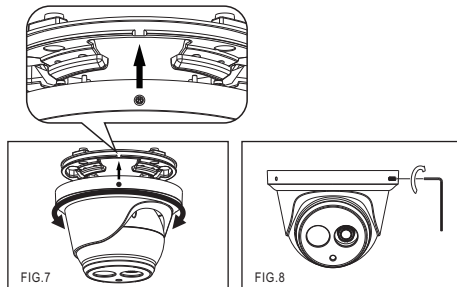

- Adjust the pan, tilt, and azimuth of the camera to the desired location (FIG.9).

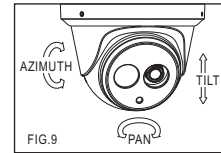

- Make sure the light sensor is at the lowest side of the camera (FIG. 1).

### System Architectures

For connecting IP Camera series to the network, please follow one of the system architectures:

- Use DC12V power adaptor and network switch connected to a network.

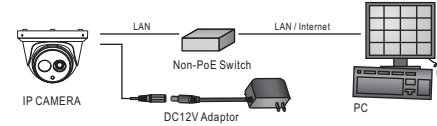

- Use with PoE of the network switch connected to the network.

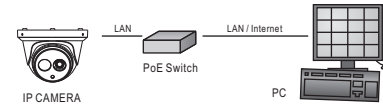

- Use PoE power injector and the network switch connected to the network.

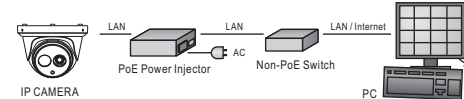

### Before Accessing IP Cameras

Before accessing the IP camera, make sure that the camera's RJ-45 network, audio, and power cables are properly connected. To set the IP address, consult your network administrator for an available IP address. The default IP address for each IP camera is 192.168.0.200. Users can use the default IP address for verifying the camera's network connection.

### Emergency Factory Default

- Short the "RESET" wire for 10 seconds before releasing.
- The camera will be restored to factory default settings after approximately 90 seconds and will reboot automatically.
- Search for the IP device using the IPScan software.
- Start the IP device via an Internet browser.
- Enter the username and password to operate.

- NOTE1:** The factory default username and password are empty, and the user can set an account for login.
- NOTE2:** The IP address will revert to the default setting of 192.168.0.200.

### Software Requirements

Universal ActiveX software components are required for web interface display of JPEG or Full HD video. When you login to the IP camera by Internet Explorer, the security warning dialog box will prompt the installation of the Universal ActiveX. Click **Install** to download it.

**Note:** This equipment has been tested and found to comply with the limits for a Class B digital device, pursuant to part 15 of the FCC Rules. These limits are designed to provide reasonable protection against harmful interference in a residential installation. This equipment generates, uses and can radiate radio frequency energy and, if not installed and used in accordance with the instructions, may cause harmful interference to radio communications. However, there is no guarantee that interference will not occur in a particular installation. If this equipment does cause harmful interference to radio or television reception, which can be determined by turning the equipment off and on, the user is encouraged to try to correct the interference by one or more of the following measures:

- Reorient or relocate the receiving antenna.
- Increase the separation between the equipment and receiver.
- Connect the equipment into an outlet on a circuit different from that to which the receiver is connected.
- Consult the dealer or an experienced radio/TV technician for help.

### Configuring IP Addresses via Web Interface

To change an IP address via web interface, type the default IP address (192.168.0.200) in the Internet browser and follow the steps below:

- Login to the Full HD IP camera with the set username and password.
- Click **Basic Mode** configuration hyperlink.
- Click **Network->General** hyperlink.
- Change the IP address, subnet mask, gateway, or HTTP port for the IP camera.
- Click **Submit** to verify the settings.

### Configuring IP Addresses with IPScan Software

To change the settings of the IP address, subnet mask, gateway, or HTTP port, you can follow the steps below:

- Run the IPScan software.
- Click **Refresh**. All available devices should be listed in the device list.
- Select your device from the list provided.
- Change the IP address, subnet mask, gateway, or HTTP port for the IP camera.
- Click **Apply** to submit the settings.
- Click **Refresh** to verify the settings.

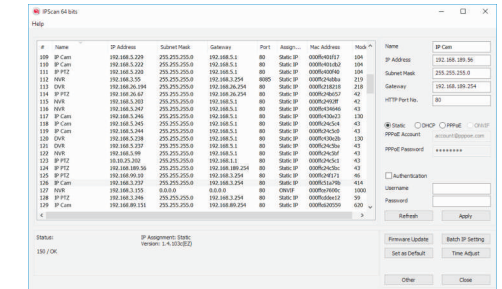

### Login

The factory default username and password are empty. To login to the Full HD IP camera, please set the username and password on the login page. Press [Login] to complete the setting and login simultaneously.



Password have to meet the following criteria:

- More than or equal to 8 characters.
- Allow uppercase letter, lowercase letter, number digit, and special character.
- Must have at least three types of character sets.

## 安裝說明

### 部件說明及尺寸

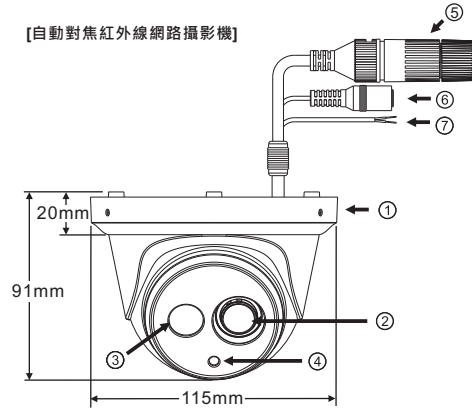
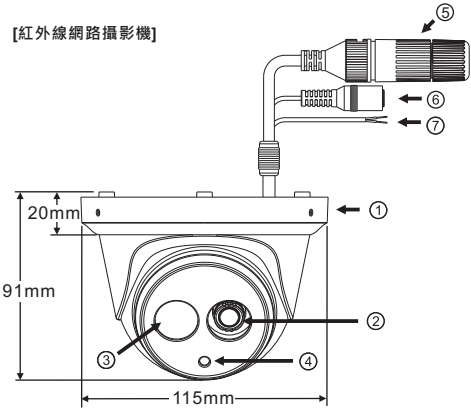

- ① 上蓋
- ② 鏡頭
- ③ 紅外線LED
- ④ 光源感應器
- ⑤ RJ-45網路接頭 (支援PoE供電)
- ⑥ 電源輸入接頭 (DC12V ±10%)
- ⑦ RESET連接線 (需要時請剝除電線外層，攝影機重設後請剪下裸露電線)

### 安裝

- 首先取出網路攝影機，使用六角板手將底座與上蓋分開 (圖1)。再取出所附的螺絲 (M4.0x25)，經由標示為 "a" 的螺絲孔，將攝影機底座固定在所需的位置上 (圖2&3)。

註：戶外建議加裝接線盒！

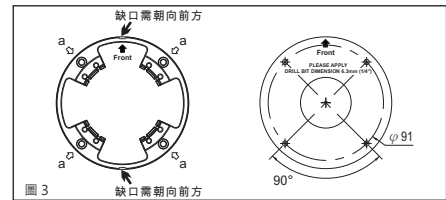
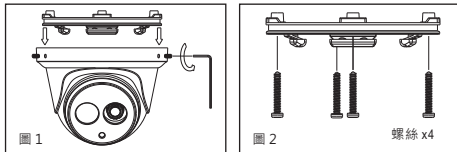

- 將網路線及電源線分別接上網路攝影機的RJ-45網路接頭與DC電源輸入接頭 (圖4)。

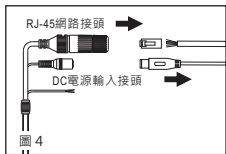

警告：此圖示，指在廢棄產品時不可直接丟棄垃圾桶，應進行拆解，並分類進行回收再利用。



- 最後，調整攝影機鏡頭的水平、垂直、傾斜攝影角度到所需監看的位置 (圖9)。

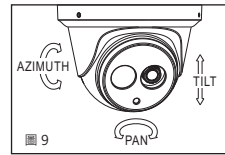

● 安裝後，請確認光源感應器位於攝影機正下方 (如圖1)。

### 系統架構

請依據下列其中一種系統架構，連結高畫質網路攝影機和您的網路。

- 使用DC12V電源變壓器和網路交換器連接網路。

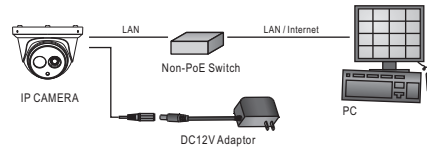

- 使用配備 PoE 的網路交換器連接網路。

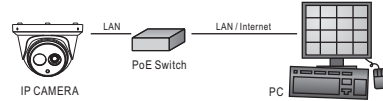

- 使用 PoE 供電裝置 (Power Injector) 和網路交換器連接網路。

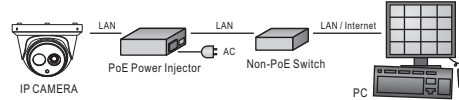

### 安裝前準備

在使用 Full HD IP 攝影機之前，請先確認攝影機 RJ-45 網路接頭和電源接頭是否接妥，並請網管人員提供一組未經使用的 IP 位址。出廠預設 IP 位址為 192.168.0.200，使用者可以先行使用該 IP 位址去更改相關網路設定。

### 回復出廠預設值

使用硬體來回復出廠預設值，請按照下列步驟：

- 短路「RESET 連接線」10 秒鐘，然後放開線路。
- 攝影機會立即還原出廠預設設定，約 90 秒後將自動重新開機。
- 使用 IPScan 軟體搜尋此 IP 設備。
- 使用網路瀏覽器開啟此 IP 設備。
- 輸入預設使用者名稱及密碼進行操作。

註1：出廠預設的使用者名稱和密碼為空白，由使用者自行設定輸入。

註2：為方便使用者起見，回復出廠預設值會回復到預設 IP 位址 192.168.0.200。

### 軟體需求

Full HD 網路攝影機需要軟體解壓縮器顯示影像，Full HD 網路攝影機的網頁介面需用該軟體。當您第一次登錄本產品，Full HD 網路攝影機的網頁介面會自動安裝 Universal ActiveX 元件，請按下「安裝」鍵安裝該元件。

### 使用 HTML 頁面來設定 IP 位址

請先在網路瀏覽器網址列，輸入預設 IP 位址 192.168.0.200，並按照下列步驟執行，使用 HTML 頁面來更改 IP 位址：

- 設定使用者名稱及密碼，登錄 Full HD IP 攝影機
- 按「組態設定」超連結
- 按「網路設定」、「一般設定」超連結
- 輸入或修改 IP 位址、子網路遮罩、網路開道 (Gateway) 或 HTTP 連接埠
- 按「確認」鍵，完成上述修改

### 使用 IPScan 軟體工具來設定 IP 位址

您可以使用 IPScan (網路設備搜尋軟體) 工具來設定 IP 位址。要更改 IP 位址、子網路遮罩、網路開道、或 HTTP 連接埠，請參照下列步驟：

- 執行 IPScan 軟體工具
- 按「更新表單」鍵，區域網路內的所有設備將顯示在設備清單欄位
- 用滑鼠點選該設備
- 編輯或修改該設備之 IP 位址、子網路遮罩、網路開道 (Gateway) 或 HTTP 連接埠等欄位
- 按「套用」鍵來更改該設定
- 按「更新表單」鍵來驗證該設定

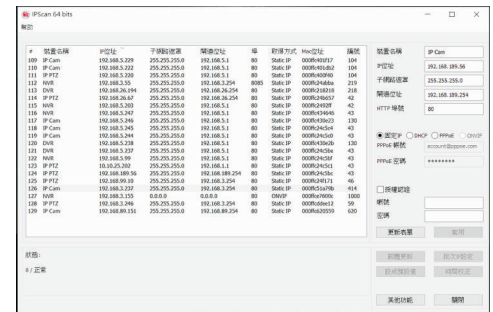

### 登入

出廠預設的使用者名稱和密碼為空白。欲登入 Full HD 網路攝影機，請在登入頁面，設定使用者名稱及密碼並按下確認鍵，可同時完成使用者設定並登入。



密碼強度要求：

- 密碼長度需要 8 個字以上。
- 密碼必須包含英文字大寫、小寫、數字及特殊符號。
- 密碼必須強制使用至少 3 種文字型態。