

Add Master Clock Controlled CD Quality Tones or Messages and Emergency Tones to Your Paging System

Viking's model **CTG-2A** is a networked clock controlled tone/message generator designed to provide accurately timed tones and/or messages over your existing paging system. This provides a cost effective way of signaling school period changes, factory shifts, breaks, lunch periods, etc. The **CTG-2A** has four programmable trigger inputs which are ideal for triggering emergency alert tones/messages to indicate fire evacuation, severe weather, lock down, all clear or can be used in store caster applications for "customer service required" announcements, etc. The **CTG-2A** can also be used as a master clock to synchronize Viking **CL Series** wireless clocks (see DOD 466).

The **CTG-2A** comes equipped with up to 6 minutes of CD quality WAV file audio storage for up to 14 different tone/messages. The unit is factory loaded with common school, business and factory tones but can be programmed with your custom tones/messages or updated from the list of WAV files from the Viking web site.

The **CTG-2A** can be programmed with up to 14 schedules and up to 1,000 events allowing you to program an entire year or multiple years of schedules in advance. The **CTG-2A's** extremely accurate time base can be manually synchronized, synchronized with 50 or 60 Hz power or can be programmed to periodically synchronize to **network or internet time**.

Features

- Up to 14 Schedules and up to 1,000 Events
- 6 minutes of CD quality WAV file record time
- Up to 14 different tones or messages
- 4 programmable trigger inputs for emergency tones, etc.
- Automatic Day Light Savings Time and leap year correction
- Programmable NTP Clock synchronization
- PC programming software included
- RS485 clock SYNC terminals for remote Master Clock control of **Viking CL Series** RF synchronized clocks
- Non-volatile memory with 4 day clock back up
- Factory loaded with school/factory tones and evacuation signals (ANSI S3.41), etc.
- Remote program via TCP/IP network
- Page trigger outputs (12VDC and DPDT relay)
- Programmable Auxiliary relay contacts (DPDT)
- 24 hour digital clock displays hours & minutes
- One mono line level pre-amp input and audio output
- Built-in 1 Watt mono audio amplifier
- One isolated audio output for PABX / dial access paging
- Master volume control
- Programmable volume control per tone/message
- Time base selection: Network, 50/60Hz or internal
- Programmable message repeat count for trigger inputs

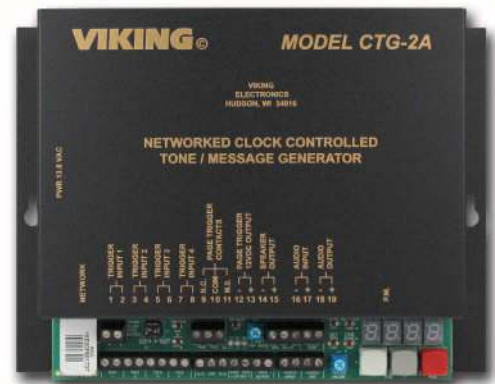

The **CTG-2A** comes with programming software and a network port to allow PC programming of timed events, schedules, clock synchronization, wave file download, message volume, day light savings time, auxiliary relay control, etc.



Installation requires the assistance of a
Network Administrator / IT Technician.

Applications

- Signal the beginning and end of class periods, breaks and lunch periods for schools
- Signal the beginning and end of shifts, breaks and lunch periods for factories/businesses
- Provide trigger controlled emergency alert messages for fire, flood, severe weather, lock down, etc.
- Provide messages at specific times for store sales, promotions, closing times, airport loading zones, etc.
- Provide Auxiliary contact activation at specific times for specific durations for controlling lights, cameras, unlocking doors/gates, etc.
- The **CTG-2A** can also be used as a Master Clock to synchronize **Viking CL Series** wireless clocks (**DOD# 466**)

Specifications

Internal Clock Backup Time: 4 days
Power: 120V AC/13.8V AC 1.25A UL listed adapter provided, max current draw: 650mA
Dimensions: 8.25" x 6.25" x 1.75" (210mm x 159mm x 45mm)
Weight: 3.2 lbs (1.5 Kg)
Environmental: 32°F to 90°F (0°C to 32°C) with 5 - 95% non-condensing humidity
Preamp (Audio 1/2) Output: 6V RMS across 600 ohms
Paging Amplifier Output: 1 watt - powers up to (2) 8 ohm or (12) 45 ohm speakers
Sound Pressure: 85 dB @ 1 meter (loud electronic warble from 25AE paging horn)
Maximum Speaker Output Wire Run: 91m (300 ft), 18 AWG
Maximum Load on Page Trigger Output: 750 ohm (15mA)
WAV File Resolution: 16 bit or 8 bit
WAV File Sampling Rate: 90 sec. of 44.1K, 3 min. of 22K or 6 min. of 11K
Time Base: 50/60 Hz or internal with NTP clock sync
Internal Time Base Accuracy: +/- 2ppm (63 seconds per year) without network time sync or manual adjustment
Connections: 29 screw terminal block positions, (1) RJ45 network jack

Features Overview

Internal 1-Watt Amp Gain Control: Adjusts speaker output volume.

Secondary Aux. Relay Output Contacts: Available on solder pads.

Page Trigger Output Contacts: DPDT relay contacts that activate when tones/messages are played. Used for triggering paging amplifier, etc.

DIP Switches (see page 18)

RS485 Clock Sync Output: Connects to CL-RFT for synchronizing time on Viking CL Series wireless clocks (DOD# 466).

Network: RJ-45 Ethernet jack for programming, uploading WAV files and NTP time syncing.

Trigger Inputs 1-4: For activating programmed tones/messages. Programmable for Normally Open (NO), Normally Closed (NC), momentary, continuous, alternate action or activate only.

Page Trigger 12VDC Output: Connect to paging amplifiers requiring a switched 12VDC signal for enabling the paging source input.

Speaker Output: 1 Watt maximum. Connect up to three 8-ohm speakers in parallel. This port is also useful for monitoring WAV file audio during programming.

Aux. Relay Output Contacts: DPDT relay contacts that can be programmed as a timed event.

Telco Page: Isolated audio output to PABX extension. For dial access paging systems or when wave files must be played only to certain zones of a multi zone paging system.

LED Display: Shows clock time, schedule, force time sync, on/off modes, sync errors, system disable, etc.

Mode Switch: Press to advance through modes (run, set time, set schedule or force time sync).

Time "+" Switch: Press to advance through time, schedules, initiate a force time sync or turn unit back on.

Time "-" Switch: Press to decrement time, select schedules or turn unit off.

Master Volume: Used to adjust overall pre-amp volume level output.

Audio Output: Line level audio output to external amplifier. This output is switched for use with existing paging or background music.

Audio Input: Line level pre-amp input for paging, background music, etc.

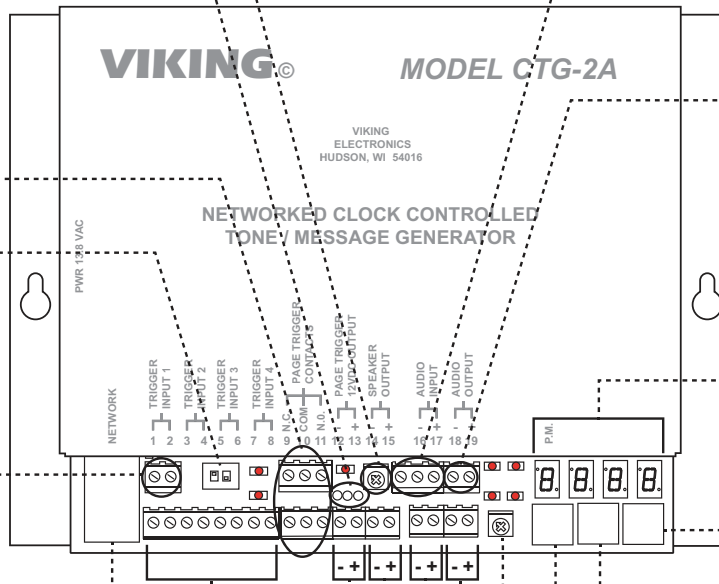

LED Overview

Run LED: Lights to indicate unit is in "RUN" (operation) mode.

Aux. Relay Active LED

Page Activity LED: Lights during tone/message playback.

Network LEDs: Lights indicating network connectivity and activity.

Audio LED: Flashes to indicate tone/message audio output.

Set Time LED: Lights to indicate unit is in "Set Time" mode.

PM LED: Lights to indicate PM time.

Time Sync LED: Lights to indicate unit is ready for a manual "Time Sync".

Set Schedule LED: Lights to indicate unit is in "Set Schedule" mode.

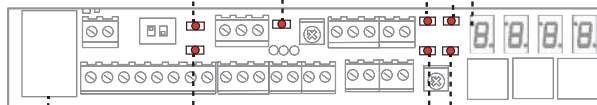

Installation

⚠ IMPORTANT: Electronic devices are susceptible to lightning and power station electrical surges from both the AC outlet and the network. It is recommended that a surge protector be installed to protect against such surges.

A. Typical Installation: Automatically Switching Paging Audio through the CTG-2A for Time Activated or Externally Triggered Messages and/or Tones

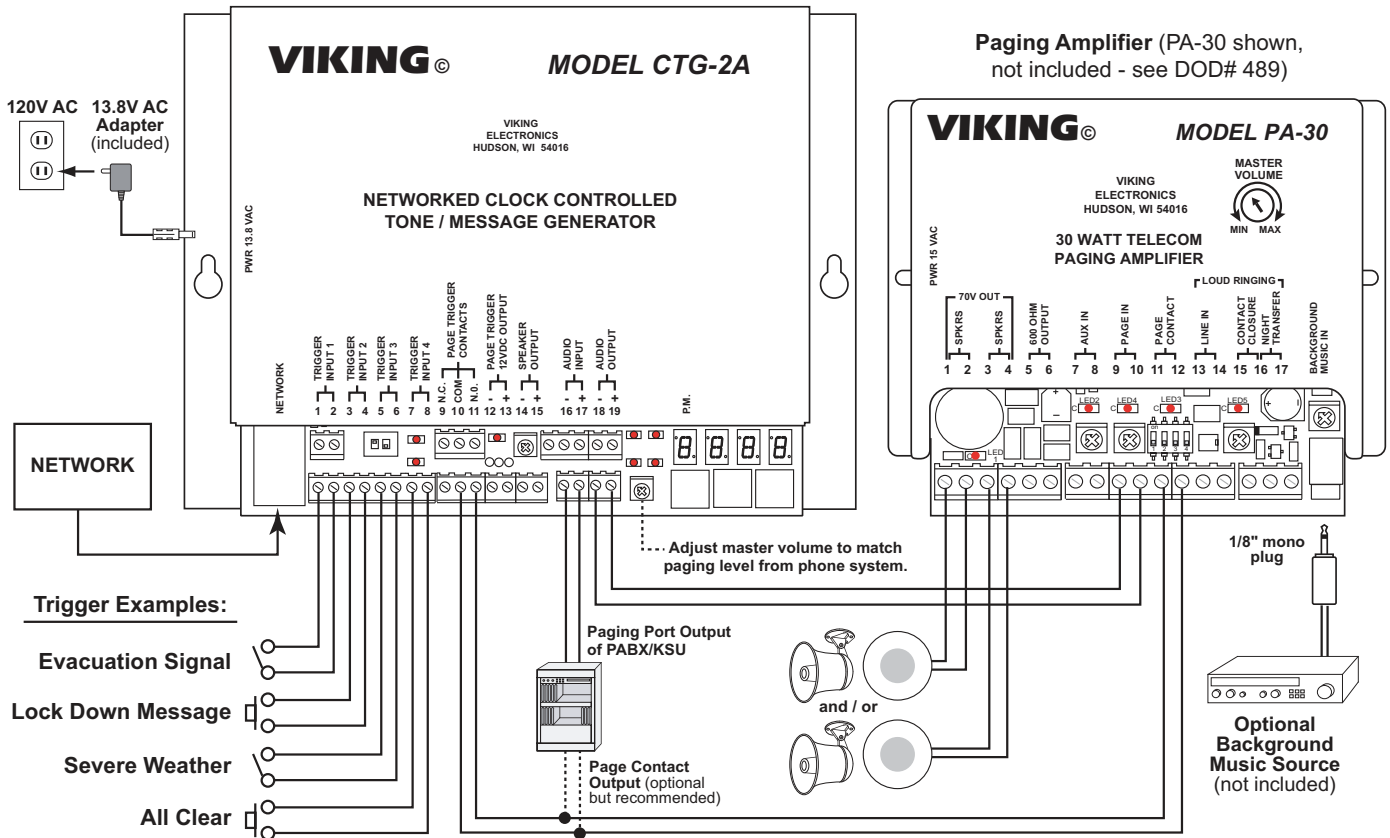

B. Using the CTG-2A as a Master Clock to Automatically Synchronize Viking's CL Series Wireless Clocks

Viking's Wireless Clock System provides reliable, accurately synchronized clocks for your entire facility. Eliminating dedicated clock wiring can save you thousands of dollars on installation and also allows for easy retrofitting of an existing installation.

The system is comprised of a **CTG-2A** master clock, a **CL-RFT** clock RF transmitter and Analog or Digital wireless clocks. Working on Viking's 915-928MHz frequency hopping technology eliminates interference with other wireless products and requires no FCC license, eliminating extraneous fees. The received signal remains strong even under the effects of noise, obstructions or long distances which tend to decrease the signal to noise ratio. Installation is a cinch for our wireless clocks, just insert the batteries or connect power and hang them. That's it.

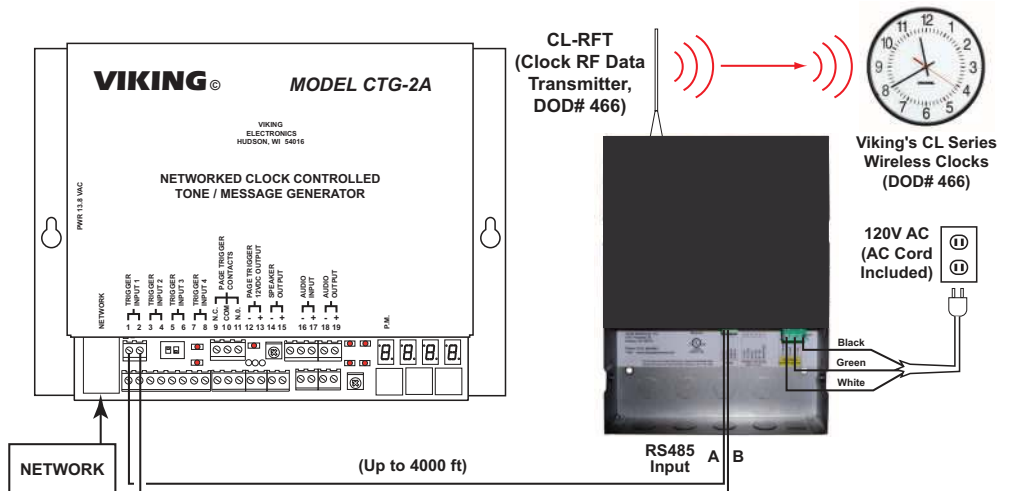

C. Connecting the CTG-2A through a PABX / Dial Access Paging System

The “Telco Page” connection allows the **CTG-2A** to seize an analog PABX extension and dial a touch tone string before playing the wave file. Useful for dial access paging systems or when the **CTG-2A** wave files must be played only to certain zones of a multi zone paging system. Another application is connecting the **CTG-2A** to the override port of a multi zone page controller, so the **CTG-2A** wave files are a higher priority than a voice page. See the “Creating Touch Tone Wave Files” application note, **DOD# 898**. Audacity can generate the required touch tones.

Notes:

1. The **CTG-2A** can only play one tone/message at a time at the top of a minute. If multiple tones or messages must play at the same time, multiple **CTG-2A**'s must be used.
2. The **CTG-2A** is limited to 14 wave file memory locations. Playing tones/messages to many different zones or zone combinations will reduce the overall number of tones/ messages that can be used.
3. When the **CTG-2A** is connected to a PABX extension and dials a touch tone string to access the paging system, the tone/message from the **CTG-2A** will not play over the speakers if the paging system is busy.

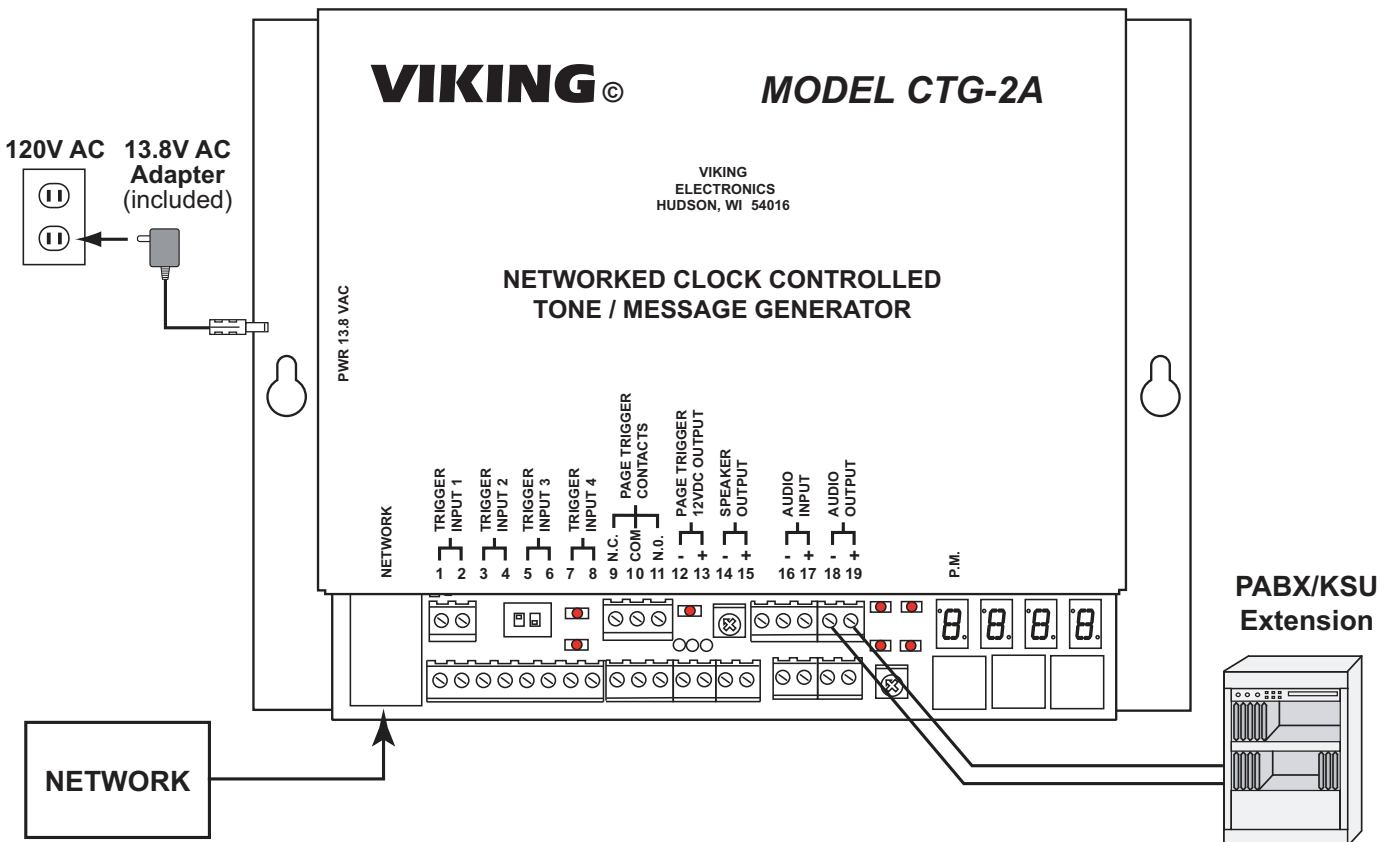

D. Playing tones/messages over certain zones or zone combinations when used with a Viking Model ZPI-4

The **CTG-2A** can play wave files to send timed tones/messages to individual zones, a combination of zones or all zones. You simply add a brief touch tone before each tone/message using Audacity or similar audio editing software. See the “Creating Touch Tone Wave Files” application note, **DOD# 898**. Audacity can generate the required touch tones.

The **CTG-2A**'s connection to the **ZPI-4** depends on the source of the voice paging. If the source of voice paging is a paging port, the **CTG-2A** is wired as shown in Diagram 1. If paging from an unused trunk port, the **CTG-2A** is wired as shown in Diagram 2. If paging from an analog extension, the two units are not directly connected together. A second analog extension can be connected to the **CTG-2A**'s “telco page” screw terminals. The **CTG-2A** would call the **ZPI-4**'s extension, pause and then dial a touch tone to select the zone or zone combination required (see section C. Connecting the **CTG-2A** through a PABX / Dial Access Paging System for more details).

1. Diagram 1 - Page Port

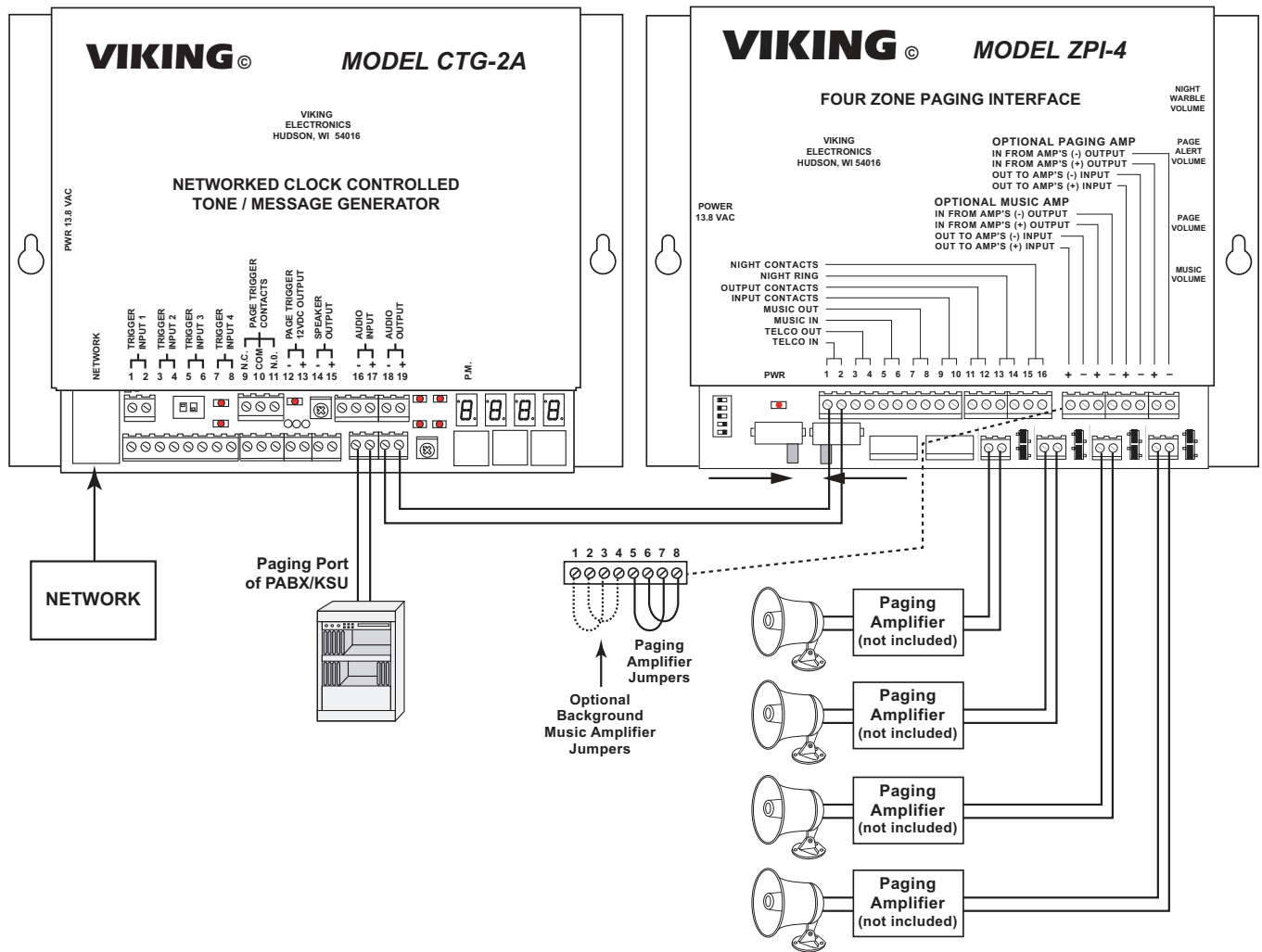

2. Diagram 2 - Unused Trunk Port

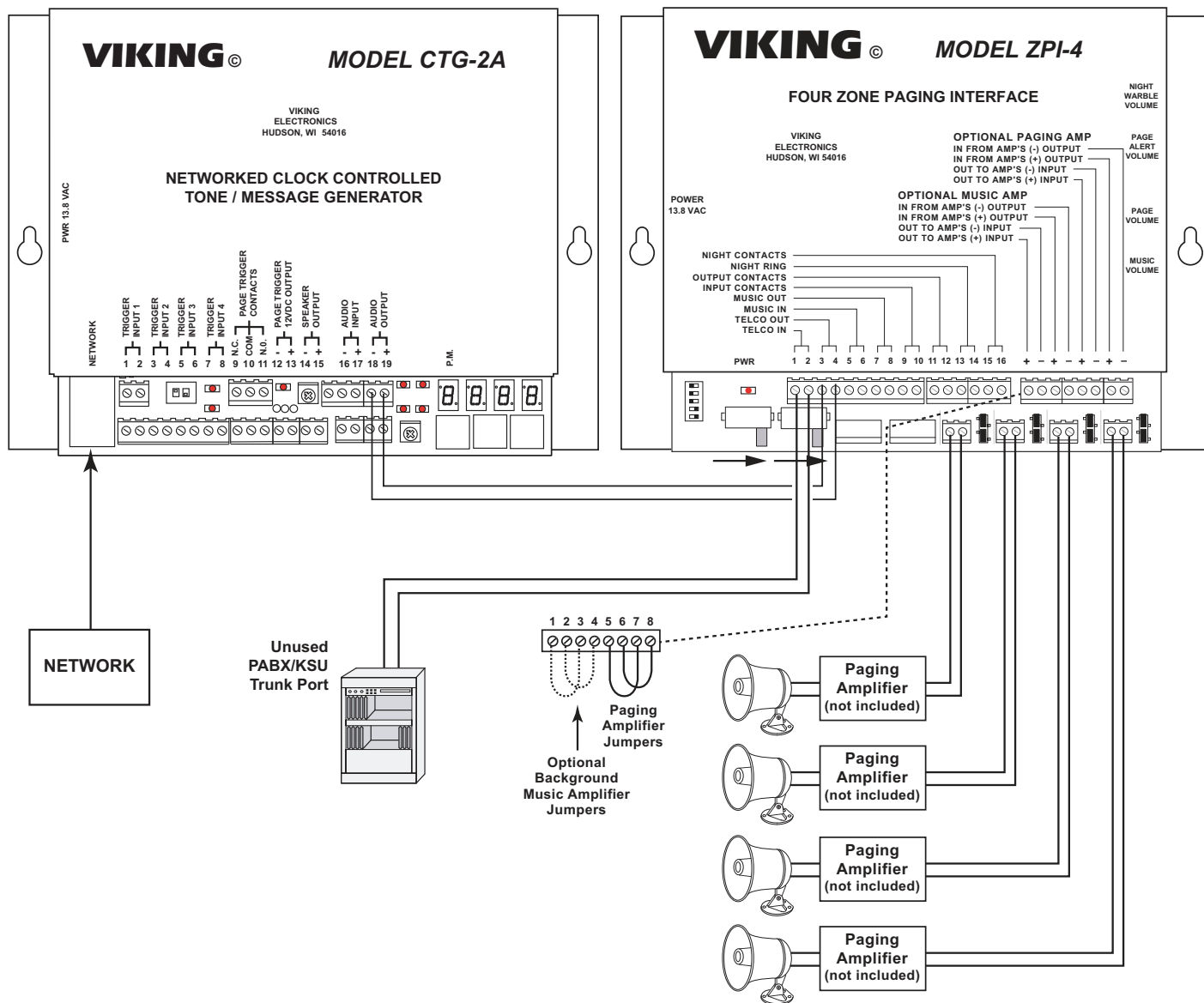

Notes:

1. The **CTG-2A** can only play one tone/message at a time at the top of a minute. If multiple tones or messages must play at the same time, multiple **CTG-2A**'s must be used.
2. The **CTG-2A** is limited to 14 wave file memory locations. Playing tones/messages to many different zones or zone combinations will reduce the overall number of tones/messages that can be used.
3. A voice page and the **CTG-2A** playing a wave file can "crash" with one another in this application, when someone voice pages and the **CTG-2A** plays a wave file at nearly the same time.
4. The operation of the **CTG-2A**'s trigger inputs is affected by this setup. The trigger inputs typically play alarm sounds (like evac signal) that are often set to repeat. When connected to the **ZPI-4**, if the trigger's wave file is set to repeat, you will hear some quiet time and the touch tone used for zone selection in between each repeat of the wave file.

PC Programming Definitions

Audio: Programming screen where you can Upload, Download, Erase, Set volume and message start delay for the wave files stored in the **CTG-2A**.

Calendar: Opens the PC programming screen “Calendar” where you can select which schedule you would like the **CTG-2A** to run on which days during the year.

Cal Err: “Cal”, “Err” will flash on the clock display any time the **CTG-2A** has lost power long enough to deplete its internal capacitor clock back up (approximately 4 days) and has one or more programmed events with specific dates or daylight savings time programmed. This can be corrected with a “Forced Time Sync” (see page 18) or enter PC programming and re-program the clock in the “Clock” screen (see page 15).

Clear Com: If you are experiencing multiple error messages while manipulating features in the “Audio” screen, select “Clear Com” and reattempt the previous programming causing the error. If this does not clear the errors, we recommend closing and reopening the program,

Conflicts: PC programming screen where you can have the software review the programmed Events and Schedule changes in your dat file to determine date or time conflicts.

Dat File: PC data file for storing CTG-2A programming data.

DHCP: Dynamic Host Configuration Protocol. It is used to automatically configure the network setting. In this procedure the network server or router takes note of a client’s MAC address and assigns an IP address to allow the client to communicate with other devices on the network.

Diagnostics: This is for use by qualified Viking Technical support personnel to view firmware memory, factory clock calibration, etc.

Download: Downloads internal programming data from the **CTG-2A** to the PC screen you have open.

Event Programming Screen: PC programming screen where you enter/program individual events to activate at specific times during the day, week or on specific dates.

Help File: Selecting the “Help” pull down menu and clicking on “Instructions” will open the “CTG-2A Help File”. Open this file for detailed instructions on PC programming of the **CTG-2A**.

MAC Address: MAC stands for Media Access Control. A MAC address, also called a hardware address or physical address, is a unique address assigned to a device at the factory. It resides in the device’s memory and is used by routers to send network traffic to the correct IP address. You can find the MAC address of your **CTG-2A** printed on a white label on the top surface of the network port.

NTP: “NTP” is the abbreviation for “Network Time Protocol”. It allows computers to synchronize time over the internet or a local network.

NTP server: The time server the **CTG-2A** should use for time syncing. It can be a local server or a server on the internet. The factory default time server is “0.viking.pool.ntp.org”.

NTP Sync: Clicking NTP Sync will activate a forced Network Clock Sync and download the current time and date. This process will take approximately 6 seconds. The current time and date will then be loaded into the **CTG-2A** and displayed under “Clock Time”. **Note:** *Unit must have internet access or be programmed for a local time server for NTP Sync.*

Off Mode: The **CTG-2A** can be placed in the “OFF” mode via push button, PC or touch tone programming. In the “Off” mode the unit will not play or activate any programming events. The unit will keep time and the 4 trigger inputs will remain functional. Unlike the “dS” (system disable) mode, in which the unit can automatically enable its self on a programmed time or date, when the unit displays “OFF” it can only be taken out of the “Off” mode manually via push button or PC programming.

Print and Print Data: Print simply prints the current screen you are working with. Print Data prints the entire Event Programming Database in a “printer friendly” format.

Save: Saves changes to the current open screen, to the PC dat file.

Snc Err: “Snc”, “Err” will flash on the clock display when the **CTG-2A** is unable to synchronize with the network. If this happens, check to make sure the **CTG-2A** has a network connection and that UDP port 123 is not blocked by your company’s firewall. Then go into PC programming under “Set Up Clock” and verify the correct time server is configured.

System Disable: This task allows you to program a specific date and/or time to disable all timed events. This is useful in schools for disabling all events during spring break, holidays, etc. Triggered inputs 1-4 will remain functional during “System Disable” times.

Programming Steps: The **CTG-2A** should be programmed in the following order:

Loading an existing dat file into a new unit

- 1 Start the software.
- 2 Connect to the new **CTG-2A**.
- 3 In the menu bar, click File, then Open.
- 4 **Check the “Open as read only” box.**
- 5 Select your file, then click Open.
- 6 If the “WARNING: Some Wave Files are not in the CTG-2A” message appears, click OK
- 7 If prompted to change your unit’s name, click Yes.
- 8 If the “Missing Wave Files” dialog appears, close it.
- 9 Click the Audio button.
- 10 If any “Lost file link” dialogs appear, click No.
- 11 In the menu bar, click File, then Open.
- 12 In the menu bar, click Tools, then Load All.
- 13 Click Close.
- 14 Click Upload.
- 15 Click Clock.
- 16 If migrating from a **CTG-2**, click Read PC’s Settings.
- 17 Click NTP Sync.
- 18 When asked to upload the clock parameters, click Yes.
- 19 Once the sync is complete, click OK.
- 20 Click Close.
- 21 In the menubar, click Tools, then Username/Password.
- 22 Enter the new username and password for this **CTG-2A**.
- 23 Check Save Username & Password if you want this computer to remember this **CTG-2A**’s login.
- 24 Click Apply, then OK.
- 25 Click Run, then Start.

Creating and programming a new dat file

- 1 Create any unique wave file sounds or messages required for your application. The **CTG-2A** is factory loaded with common school and factory shift change sounds.
- 2 Start the software and connect to the new **CTG-2A**.
- 3 In the “File” pull down menu click “New File”. Enter a name for your dat file and unit. Click Apply. If asked to clear the **CTG-2A**’s programming, click Yes. A dialog box will appear instructing you to clear wave files. Click OK.
- 4 Click on “Audio”. If any “Lost file link” dialogs appear, click No. In the menu bar, click Tools, then Erase All. Upload the wave files into the **CTG-2A**. When finished, click Save, then Close.
- 5 Program your events line by line in the “Event Programming” screen. Entering the events in chronological order is helpful during programming but not required as you can select “Sort Events” when you have finished.
- 6 Check for any programming conflicts by clicking on the “Conflicts” button.
- 7 Program the Time and Date in the “Clock” screen. Set your time zone, then click Read PC’s Settings. Do a NTP sync, uploading the clock parameters when asked.
- 8 Program Triggers 1 - 4 to play your desired wave sounds.
- 9 If more than one schedule has been programmed, click on “Calendar” to open the “Calendar” screen and select the dates that you would like to run each schedule.
- 10 Save your programming changes and upload the dat file to the **CTG-2A**.
- 11 Set a new Username and Password.
- 12 Run a specific schedule or select “Automatically Switch Schedules” to have the unit automatically switch schedules at 12:00 AM on your programmed dates.

Note: The data in the “Notes” field is not used by the **CTG-2A** and is only stored in the dat file for the convenience of the user. If the dat file is lost and a download is performed, all “Notes” will be blank.

System Requirements

- **IBM** compatible personal computer with:
 - Windows 7, 8 or 10 / Server 2012, 2016 or 2019
- Adobe Acrobat Reader 8 or higher
- **CTG-2A** hardware
- Internet connection
- Ethernet switch with available port
- Ethernet cable (NOT provided with **CTG-2A** hardware)
- 120MB minimum free hard drive space for installation
- 64MB of free physical RAM

PC Programming

Download and install the programming software

1. Go to www.vikingelectronics.com and enter **CTG-2A** in the search box
2. Click **CTG-2A** in the search results
3. Scroll down the page to Downloads, click **CTG-2A Programming Software**
4. Install the programming software by saving or opening the file and then clicking on **setup.exe**
5. Follow the prompts on your screen to complete software installation
6. To start the Viking **CTG-2A** application, click on the Viking **CTG-2A** icon on your desk top. The Main screen will appear, allowing the user to program any **CTG-2A** connected to that LAN.

Note: PC must be connected to the same LAN as the **CTG-2A**.

ATTENTION: Before using the **CTG-2A**, the **CTG-2A** application must be installed.

When you first start the program the Connect screen will appear. The software will scan the local network for the **CTG-2A** automatically when this screen is started. Select a device from the list or enter its address in the field and click "Connect". If you want to work offline, click "Work Offline" When you exit this screen, the Event Programming screen will appear.

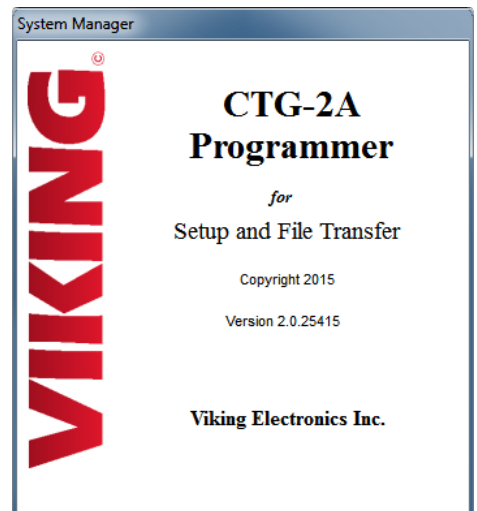

The Event Programming screen allows the user to enter/program individual events to activate at specific times during the day, week or on specific dates. Events include: Play specific Wave file, Enable or Disable the system, Activate Time Sync, Turn Aux Relay On/Off, Activate programmable timed Aux Relay and Change Schedule on specific dates. The Event Programming example shown on page 11 is factory loaded into the **CTG-2A** allowing you to get familiar with programming or modify this file for your own use.

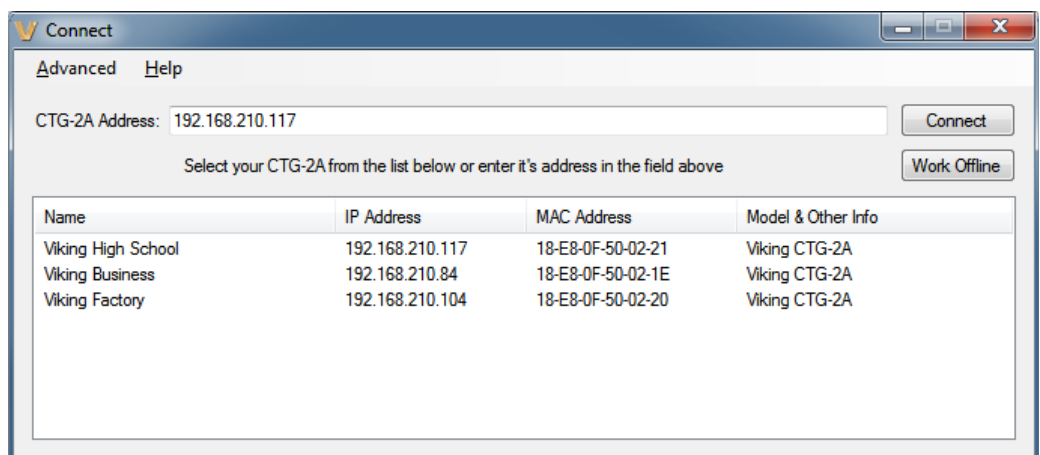

A. Downloading WAV Files (optional)

The **CTG-2A** comes factory loaded with 14 CD quality tones and emergency sounds commonly used in school and factory applications. The **CTG-2A** can be uploaded with any user edited WAV file sounds or messages. See “WAV File Guidelines” below.

WAV File Guidelines:

1. For best results, the WAV file should be 16 bit / 44.1K / mono.
2. Resolution down to 8 bits is acceptable but audio quality will not be optimal.
3. Sampling rates of 22k and 11k are also acceptable.
4. The WAV file may be stereo or multi-channel, but only the Left Channel will be loaded.
5. Each of the 14 Memory Locations can hold up to 26 seconds of recorded audio (at 11k sample rate).
6. Total recording time of 6 minutes 15 seconds available (at 11k sample rate).
7. Longer recordings are allowed to spill over into additional memory locations.

Note: If you create custom WAV files and load them in the **CTG-2A**, keep a backup copy of these custom WAV files. Burn a copy of your WAV files to a CD or copy them to a USB memory stick. If there is a catastrophic failure of the PC used to program the **CTG-2A**, these backup copies of the WAV files can be used to reload the original WAV files back into the **CTG-2A**, so all audio features can still be used. See **DOD# 899 “Capture All Data from the CTG-2A and Use the Currently Loaded Wave Files.”** Applications such as Sound Forge, Audacity, and Windows Sound Recorder can be used to generate WAV files out of Audio CD and/or MP3 audio recordings.

B. Uploading WAV Files to the CTG-2A

Audio: Clicking the “Audio” button in the “Event Programming” screen will open the “Audio” programming screen where you can Upload, Download, Erase, Set the volume and message start delay for the wave files stored in the **CTG-2A**.

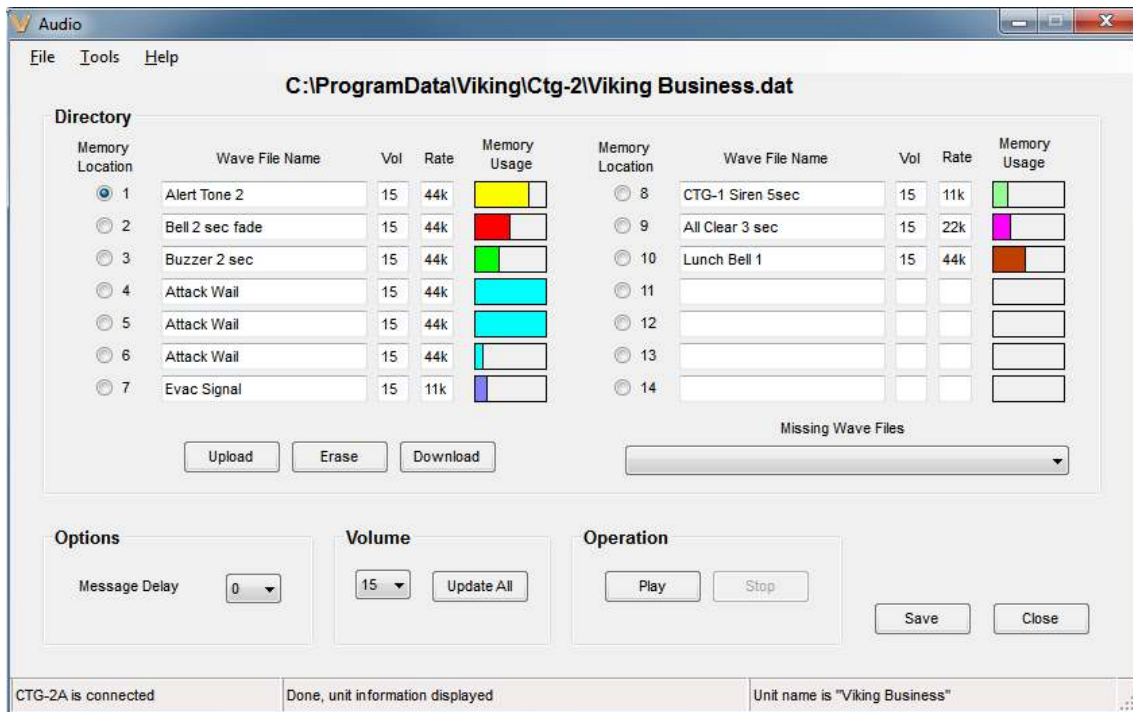

Message Delay (sec): Adjustable from 0 to 9 seconds in half sec increments. This is the delay from when the page trigger output is activated until the start of the wave file is played. Adjusting this can eliminate cutting off the first section of the wave file in applications where certain paging amplifiers require a second or two to power up and/or switch to that audio source.

Memory Usage: The **CTG-2A’s** wave file memory storage is separated into 14 memory blocks and is displayed after each wave file name under the column titled “Memory Usage”. The memory blocks will fill with color after uploading a wave file showing how much memory space was required for that file. Larger wave files will require multiple memory blocks. To conserve memory storage space you can reduce the sampling rate of the wave file from 44K to 22K or 11K. Note: Reducing the sampling rate will decrease the sound quality of the message/sound.

Missing Wave Files: If the **CTG-2A** does not have a wave file in its internal memory that is required by the PC dat file you have open, “Missing Wave Files” will be highlighted in red. To upload the missing wave file to the **CTG-2A**, open the drop down menu and click on the missing wave file. The file will then be automatically uploaded to the **CTG-2A**.

Volume: The “Volume” box allows you to adjust and set the volume level of each individual wave file. This is useful for matching the volume levels of each wave file or increasing the volume on specific wave files such as evacuation sirens, etc. **Note:** Volume cannot be changed by clicking on the volume field next to the wave file name. Select the memory location you would like to change and alter the volume using the “Volume” box at the bottom of the window.

Update All: After adjusting the wave file volume levels (adjusted volume settings will be highlighted in red) select “Update All” to save the volume settings for all wave files.

Load All: In the “Tools” drop down menu, selecting “Load All” will upload all the wave files from the currently open “Audio” screen into the correct memory locations in the **CTG-2A**. **Note:** To load all the wave files from the currently open dat file, click “Open” in the “File” drop down menu, then select “Load All” from the “Tools” drop down menu. The **CTG-2A** programmer software will then automatically erase and upload each wave file memory location in the **CTG-2A**.

Erase All: In the “Tools” drop down menu, selecting “Erase All” will erase all 14 wave file memory locations in the **CTG-2A**.

Play: Clicking on “Play” will signal the **CTG-2A** to play the selected wave file. This is useful for setting the volume levels for each wave file.

Change Rate: In the “Tools” drop down menu, clicking on “Change Rate” opens the “Rate/Size Calculator” which allows you to reduce the sampling rate of the selected wave file to reduce the memory storage capacity needed. (right) **Note:** It is not possible to reduce the rate of a file occupying only one block. **Caution:** The “Rate/Size Calculator” can only be used to reduce a wave file’s sampling rate. To increase the sampling rate, the wave file must be erased and reloaded.

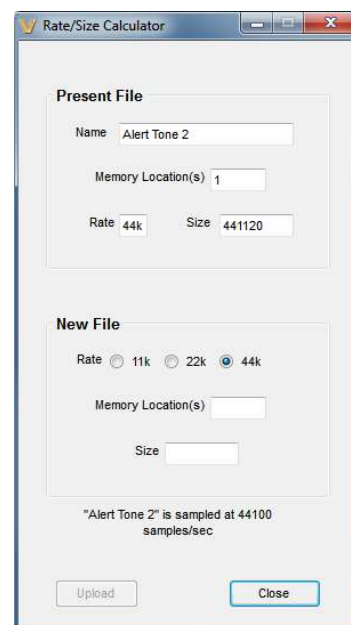

C. Event Programming

Event	Task	Aux Rly Time	Vol	Start	Time	Stop	Sun	Mon	Tue	Wed	Thur	Fri	Sat	Schedule	Notes
1	Change Schedule			1/2/2015	12:00 AM	1/19/2015	X	X	X	X	X	X	X	1-Regular	Martin Luther King Jr. Day
2	Change Schedule			1/20/2015	12:00 AM	2/16/2015	X	X	X	X	X	X	X	1-Regular	Washington's Birthday
3	Change Schedule			2/17/2015	12:00 AM	5/25/2015	X	X	X	X	X	X	X	1-Regular	Memorial Day
4	Change Schedule			5/26/2015	12:00 AM	7/3/2015	X	X	X	X	X	X	X	1-Regular	Independence Day
5	Change Schedule			7/4/2015	12:00 AM	9/7/2015	X	X	X	X	X	X	X	1-Regular	Labor Day
6	Change Schedule			9/8/2015	12:00 AM	10/12/2015	X	X	X	X	X	X	X	1-Regular	Columbus Day
7	Change Schedule			10/13/2015	12:00 AM	11/11/2015	X	X	X	X	X	X	X	1-Regular	Veterans Day
8	Change Schedule			11/12/2015	12:00 AM	11/26/2015	X	X	X	X	X	X	X	1-Regular	Thanksgiving
9	Change Schedule			11/28/2015	12:00 AM	12/24/2015	X	X	X	X	X	X	X	1-Regular	Christmas
10	Change Schedule			12/26/2015	12:00 AM	1/1/2016	X	X	X	X	X	X	X	1-Regular	New Year's Day
11	Change Schedule			1/2/2016	12:00 AM	1/18/2016	X	X	X	X	X	X	X	1-Regular	Martin Luther King Jr. Day
12	Change Schedule			1/19/2016	12:00 AM	2/15/2016	X	X	X	X	X	X	X	1-Regular	Washington's Birthday
13	Change Schedule			2/16/2016	12:00 AM	5/30/2016	X	X	X	X	X	X	X	1-Regular	Memorial Day
14	Change Schedule			5/31/2016	12:00 AM	7/4/2016	X	X	X	X	X	X	X	1-Regular	Independence Day
15	Change Schedule			7/5/2016	12:00 AM	9/5/2016	X	X	X	X	X	X	X	1-Regular	Labor Day
16	Change Schedule			9/6/2016	12:00 AM	10/10/2016	X	X	X	X	X	X	X	1-Regular	Columbus Day
17	Change Schedule			10/11/2016	12:00 AM	11/11/2016	X	X	X	X	X	X	X	1-Regular	Veteran's Day
18	Change Schedule			11/12/2016	12:00 AM	11/24/2016	X	X	X	X	X	X	X	1-Regular	Thanksgiving
19	Change Schedule			11/28/2016	12:00 AM	12/24/2016	X	X	X	X	X	X	X	1-Regular	Christmas

Connect: Located in the “Event Programming” screen’s “Tools” pull down menu. This is used if you want to connect to a different **CTG-2A** or are programming “Off Line” (**CTG-2A** not connected to PC) then want to connect to the unit and upload the updated programming data.

Unit Name: Located in the “Event Programming” screen “Tools” pull down menu, this is useful if you have several units in multiple locations with the same “dat” file. For single unit applications we recommend using the “dat” file name for the unit name.

New File: Select this to create a new Event Programming dat file (right).

Open: Select this to open an existing Event Programming dat file (right).

Import: Select this when opening an existing Event Programming dat file that was previously programmed from a different PC (right).

Add/Edit Event: Add each of your events by double clicking on any field in the next available event (except the event number field). This opens the “Edit Event” screen that is used to program or edit the one specific event (below right). If using multiple schedules and you wish to copy a complete schedule, see “Block Edit” on page 14. If using multiple schedules and the Calendar mode, you can disregard the “start date” and “stop date” when programming your events. Once all of your events and schedules are programmed, you can use the Calendar screen to decide which schedule is running each day and to disable tones on weekends, holidays, etc.

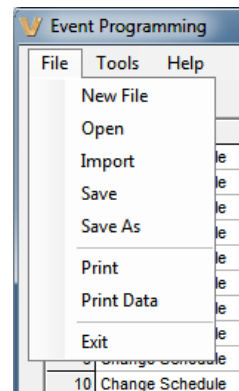

Task: This pull down menu allows you to program a specific event such as to play a preprogrammed (uploaded) wave file, Change Schedule, turn the Aux relay on or off, activate a timed Aux relay, activate an automatic Time Sync on a specific time and/or date or Start a System Disable/Enable at a specific time and/or date.

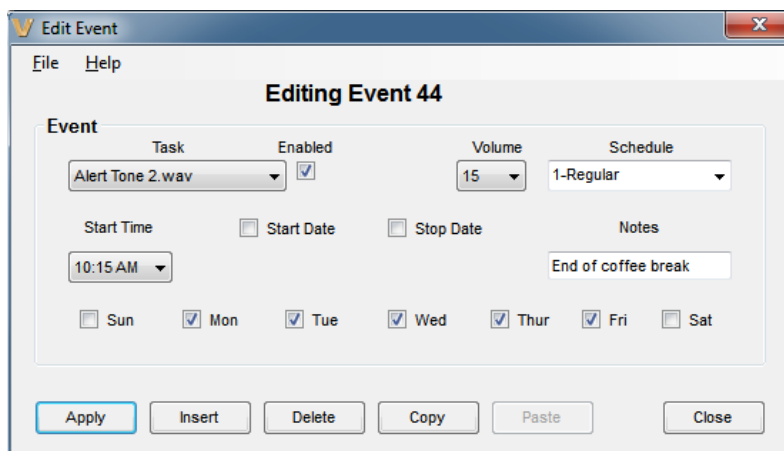

Time Sync: Located under “Task” pull down menu. This is for programming an automatic NTP synchronization event. This requires an internet connection or local time server. The CTG-2A’s internal clock accuracy is +/- 2ppm or approximately +/- 63 seconds per yr. This accuracy can be greatly increased by programming Time Sync events daily or weekly. We recommend programming the Time Sync Start Time for after hours and at an odd time to help minimize server load. Do not perform time syncs more frequent than twice an hour.

Duration: For a timed Relay event, this box sets the length of time the auxiliary relay will be actuated.

Time Dly (sec): For an Aux Relay On or Off event, this box sets the length of delay time (0.5 to 59.5 sec) before the auxiliary relay will be turned on or off.

Start Date/Stop Date: The easiest way to program start and stop dates is to program them in the “Calendar” screen. The start and stop times cannot be programmed and are fixed to 12:00am. Start and stop dates can also be programmed in the event programming screen. Double click in the event row to open the “Edit Event” screen. The Start and Stop pull down menus allow you to program Start and Stop dates for that specific event. Example: You would like to let your employees off work an hour early during the week before Christmas. Simply program an event to play your normal 5:00 end of shift tone at 4:00 with start and stop dates for the week before Christmas.

Notes: This field in the “Edit Event” screen is useful for entering notes explaining what the event is signaling such as “Period 2 Start”, “Lunch End”, “Shift 3 Start”, etc. The “Notes” field is only used for the convenience of the user and is stored in the PC dat file. The **CTG-2A** does not make use of this information. **Note:** *The first character in the “Note” field should NOT start with a number as it will right justify the text.*

System Disable: This task allows you to program a specific date and/or time to disable all timed events. This is useful in schools for disabling all events during spring break, holidays, etc. Triggered inputs 1-4 will remain functional during “System Disable” times. **Note:** *If programmed using the “Calendar” screen, start and stop times will take place at 12:00AM. If specific times other than 12:00AM are required, the “Edit Event” screen must be used. When the CTG-2A is in the “System Disable” Mode, the LED display will state “dS”.*

System Enable: If “System Disable” has been programmed via the “Edit Event” screen, a “System Enable” event can be programmed to re-enable the **CTG-2A** to activate timed events.

Upload: Uploads all data from the current open PC screen to the **CTG-2A**. **Note:** *Uploading from the main “Event Programming” menu will upload data from all programming screens to the **CTG-2A** and automatically save data from all menus to the PC dat file.*

Download: Downloads internal programming data from the **CTG-2A** to the PC screen you have open. **Caution:** *Download can be used for viewing but should not be used for editing as it does not contain information from the “Schedule” or “Notes” column of the Event Programming screen. All editing should be done by opening the dat file.*

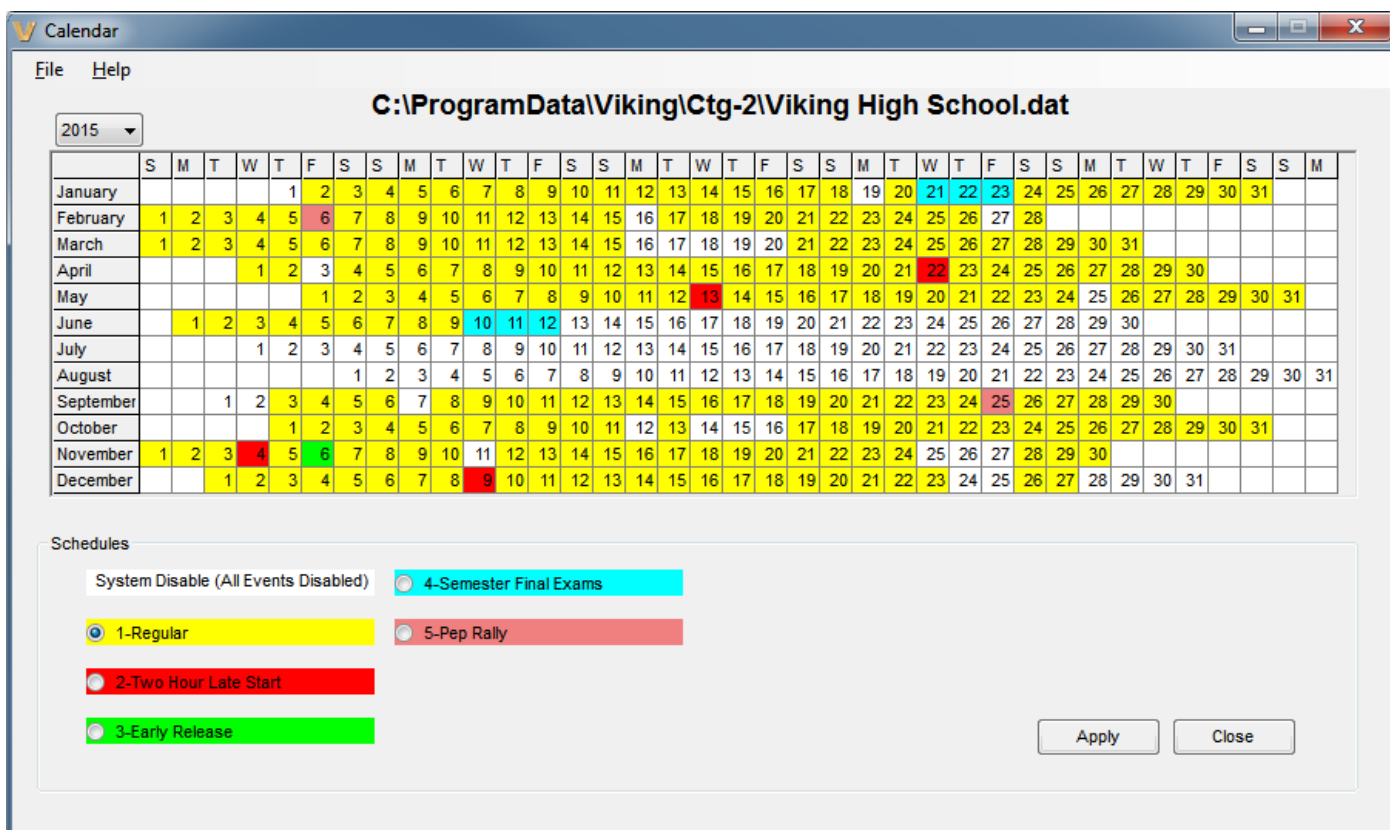

Calendar: Clicking the “Calendar” button in the “Event Programming” screen will open the “Calendar” programming screen where you can select which schedule you would like the **CTG-2A** to run on which days during the year. This is programmable out to the year 2098 allowing you to program multiple years in advance if required. Simply select a preprogrammed schedule and click on the dates you would like that schedule to run. By clicking and highlighting, multiple dates can be changed at once. When utilizing the “Calendar” schedule changes will take place at 12:00 AM. **Note:** Schedules must be programmed in the “Event Programming” menu first, and then the schedules can be programmed for specific dates utilizing the “Calendar” screen. **Note:** The **CTG-2A** will only follow schedule change events when running in Automatically Switch Schedules Mode.

Manual Schedule Changes (versus using the Calendar screen): You are allowed to program your own schedule changes instead of using the Calendar screen that automatically creates schedule changes for you. You then program the schedule changes as events, specify the schedule you are changing to and the start and stop dates for this schedule change. Additional information about manual schedule changes:

1. Multiple schedule changes on a particular day are not supported.
2. The start and stop times for all manual schedule changes is fixed at midnight and cannot be changed. The “Start Time” field on the “Edit Event” screen is grayed out (not available) when programming a schedule change event.
3. When all programming is completed (and uploaded to the **CTG-2A**) and you are ready to start the unit running, run the **CTG-2A** in the Automatically Switch Schedules mode. The **CTG-2A** will only follow schedule change events when running in Automatically Switch Schedules Mode.

Run: Click this button to exit PC programming and place the **CTG-2A** in run mode. Simply press the “Run” button, select the desired fixed schedule or Automatically Switch Schedules and press “Start”. Note: If you are starting the **CTG-2A** during a preprogrammed time for “System Disable” or “Aux Relay On”, check the appropriate boxes then click “Start”.

Automatically Switch Schedules: If more than one schedule is programmed you can run the unit in the Automatically Switch Schedules Mode. In the Automatically Switch Schedules Mode the **CTG-2A** will automatically switch on/off and to different schedules per the dates programmed in the “Calendar”. Schedule changes will take place at 12:00 AM. **Note:** Multiple schedule changes on a particular day are not supported.

Exit: Clicking “Exit” with a dat file open will prompt you “Do you want to start running?” Selecting “Yes” or “No” will exit and close the **CTG-2A** programming software. If “no” was selected the **CTG-2A** will display “OFF” and will not activate any programmed events. The 4 trigger inputs will remain functional. If “Yes” was selected the “Run” menu will appear allowing you to select the “Automatically Switch Schedules” or any preprogrammed schedule. Click on “Start” and the **CTG-2A** will begin running the selected schedule.

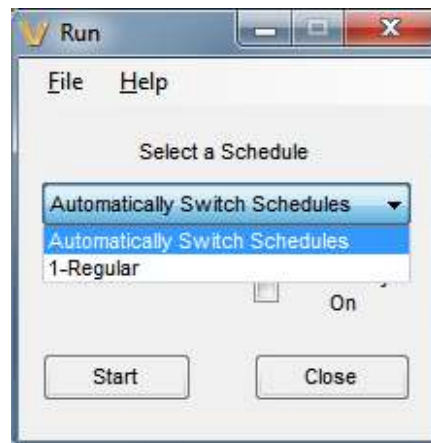

Block Edit: This screen opens after single clicking in the Event row. By clicking and highlighting, entire blocks of events can be selected. This is used to Copy, Cut, Paste, Insert or Delete single or multiple Event rows. This can be useful for copying an entire schedule then modifying the event times slightly for early release, late start, etc. (above).



Conflicts: Clicking the “Conflicts” button will open the Conflicts screen where you can have the software review the programmed Events and Schedule changes in your dat file to determine date or time conflicts. This will also check for conflicts if a wave file is not finished playing before another event is scheduled to activate. When you have finished programming your dat file, click on “Conflicts”, and select “Automatically Switch Schedules” or which schedule you would like to check for conflicts then click “Review”. The “Conflicts” screen will display all the events with conflicts and the “Event Programming” menu will highlight the events with conflicts in yellow. Make corrections to the highlighted events then review conflicts again. (below) **Note:** If using multiple schedules and Automatically Switch Schedules Mode, check each schedule for conflicts first, then check Automatically Switch Schedules for conflicts.

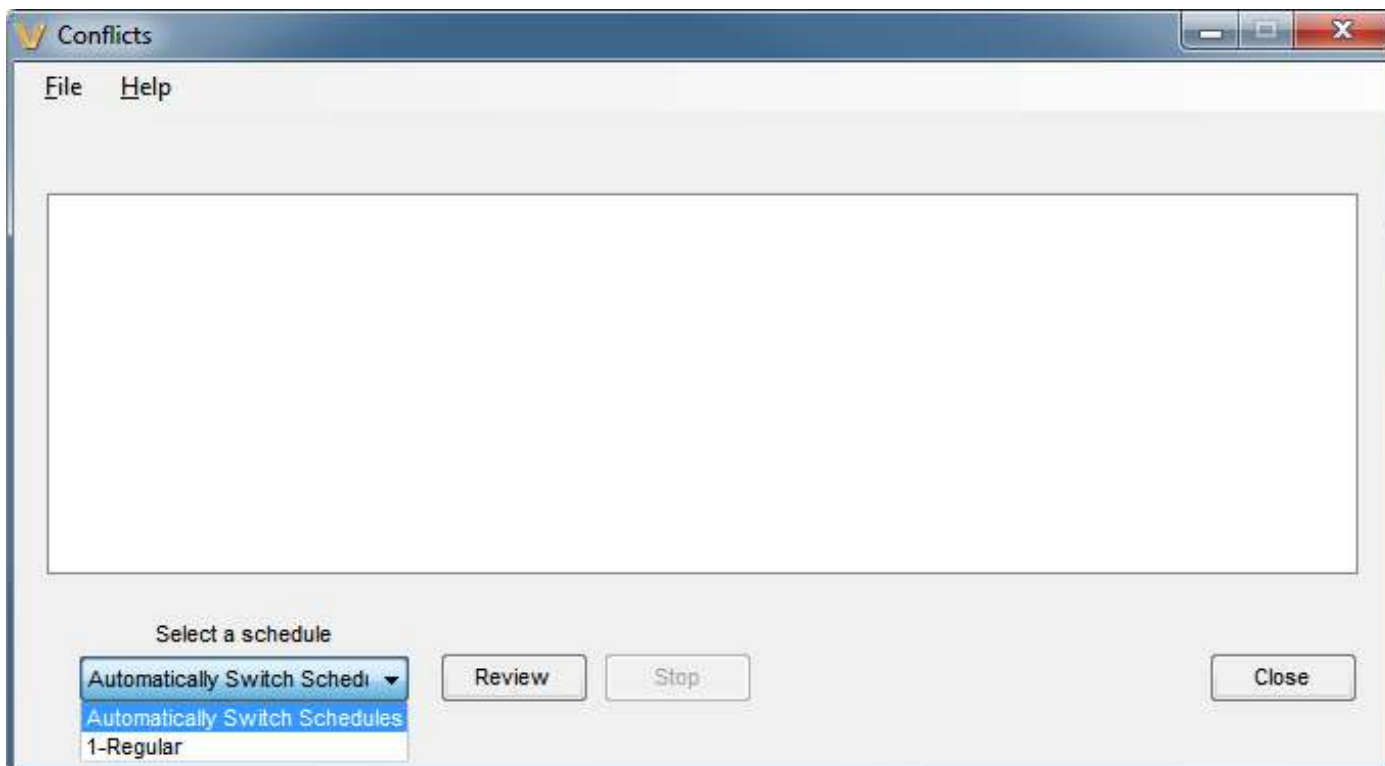

Sort Events: When you are finished programming all your events in your dat file, you can select this feature to automatically sort all of the events in chronological order starting with all your change schedules events for schedule 1. In the “Event Programming” screen select the “Tools” pull down menu and click “Sort Events”. (right) **Note:** The “Sort Events” feature is irreversible.

Username/Password: Located in the “Event Programming” screen’s “Tools” pull down menu. This feature allows you to change the username and password used to login to the **CTG-2A**. The username and password can be up to 32 characters each (fewer if non-ASCII). These fields are Unicode, thus any and all characters in any language are allowed. However usernames containing non-English or special characters must be shorter. The default username is “admin”. The default password is “viking”.

Network Settings: Located in the “Event Programming” screen’s “Tools” pull down menu. This sets the network settings for the **CTG-2A**. Do not change these settings unless instructed to by your network administrator.

Diagnostics: This section is password protected. Only access this area if directed to do so by Viking Technical Support personnel (this allows you to view firmware memory, factory clock calibration, etc.)

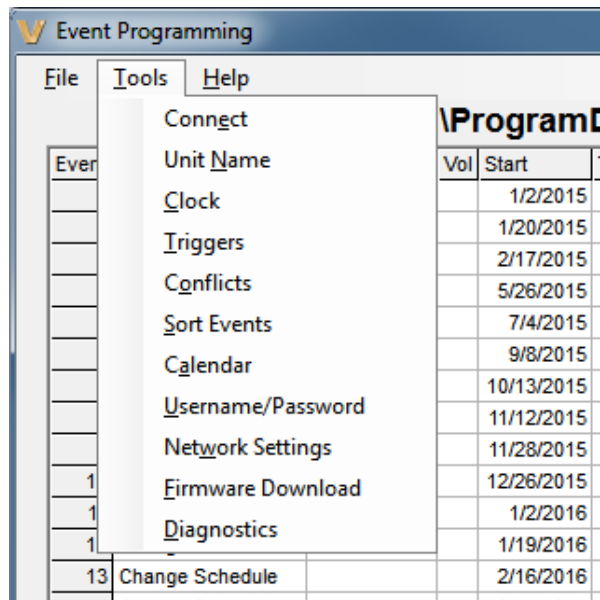

Clock: Clicking the “Clock” button will open the “Clock” programming screen where you can enter/program Clock Parameters such as Time base (Internal, 50 Hz or 60Hz), Time Zone and Daylight Savings Time, program Clock Time (Manual, PC time or NTP Sync) and program Time Server Settings. Note: It is recommended that you use the “Internal” time base which has an accuracy of 2 ppm (+/- 63 seconds per year). Additional accuracy can be achieved by programming periodic “Time Sync” events in the Event Programming screen. “AC Line 50 or 60 Hz” time base should only be used in legacy applications where the AC powered building clocks are synchronized to the AC line power frequency. **Note:** After changing the Time Base AC line frequency setting, momentarily power down the unit.

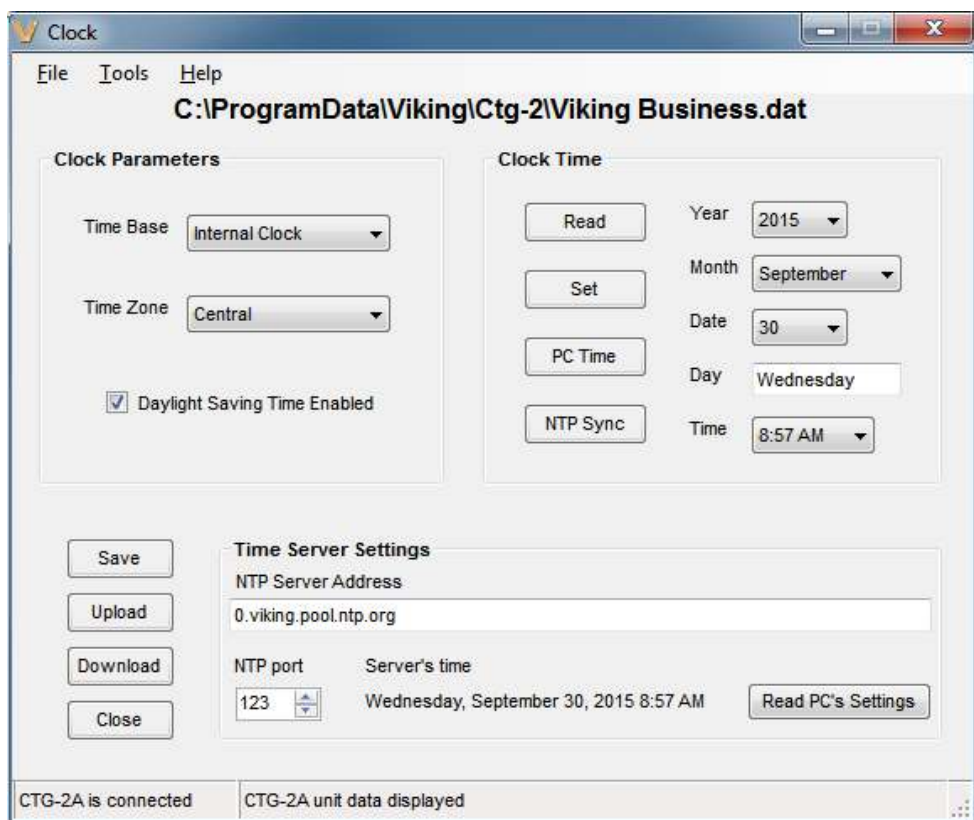

Time Base: In the “Clock” screen, click this pull down menu to select the **CTG-2A**’s time base. With “Internal Clock” selected the **CTG-2A** will base its time off its internal crystal controlled (quartz) real time clock with an accuracy of approximately 2 ppm which is +/- 63 seconds per year without NTP clock sync. **Note:** This accuracy can be greatly increased with periodic NTP Synchronization or periodic manual clock corrections. With AC Line 50 or 60 Hz selected the **CTG-2A** will base its time off the AC voltage powering the unit. The clock accuracy will then follow the power company fluctuations. This can be useful for matching the **CTG-2A** time to existing AC powered clocks.

Time Zone: Clicking this pull down menu will allow you to select the correct time zone for your region.

Daylight Savings Time Enabled: Check this field to enable automatic daylight savings time correction. The **CTG-2A's** internal clock will then be advanced 1 hour at 2:00 AM of the Starting Sunday and dropped back 1 hour at 2:00 AM of the Ending Sunday.

Read: Clicking "Read" will display the current internal **CTG-2A** clock time and date.

Set: Clicking "Set" will upload the **CTG-2A** with only the time and date parameters displayed in the "Clock Time" section of the "Clock" screen. **Note:** Clicking "Upload" will send clock time and all other parameters in the "Clock" screen.

PC Time: Clicking this will use the current time and date from your PC to set the time and date in the **CTG-2A's** internal memory.

NTP Sync: Clicking NTP Sync will activate a forced Network Time Sync. This process will take approximately 6 seconds. The current time and date will then be loaded into the **CTG-2A** and displayed under "Clock Time".

NTP Server Address: "NTP" is the abbreviation for "Network Time Protocol". It allows computers to synchronize time over the internet or a local network. The address can be an IP address or a URL, a local or a server on the internet. This field is factory loaded with the internet server pool "0.viking.pool.ntp.org". This setting is not stored in the dat file.

NTP port: This is the UDP port the time server NTP uses. Only change this value if instructed by your network admin.

Read PC's Settings: Clicking Read PC's Settings attempts to read your PC's time server settings. If it succeeds, those settings will be displayed under NTP Server Address. You will still need to click upload to apply these settings to the **CTG-2A**. This works best if the computer is a member of a domain. **Note:** This function is only available if the program is run as Administrator.

Daylight Savings Time: In the "Tools" pull down menu. This screen allows you to program the starting and ending month and Sunday for the automatic change to Daylight Saving Time. Use the pull down menus to select the starting and ending month and Sunday then click "Upload" to send the data to the **CTG-2A**. The **CTG-2A's** internal clock will then be advanced 1 hour at 2:00 AM of the Starting Sunday and dropped back 1 hour at 2:00 AM of the Ending Sunday. (below)



Triggers: Clicking the “Triggers” button in the “Event Programming” section will open the “Triggers” programming screen where you can enter/program the parameters for Trigger Inputs 1-4 such as which wave file to play, Contact (N.O./N.C.), Trigger Mode (Alt Action/Activate Only), Play Count (1-99 or Continuous), Volume setting, Type (Mom / Cont) and Playback Mode (Interrupt/stack).

Note: The **CTG-2A** is factory loaded with the following wave files for Trigger Inputs 1-4:

Trigger 1: Evac Signal.wav (ANSI S3.41/ISO 8201 Audible Emergency Evacuation Signal)

Trigger 2: All Clear 3 sec.wav

Trigger 3: Attack Wail.wav

Trigger 4: CTG-1 Siren 5sec.wav

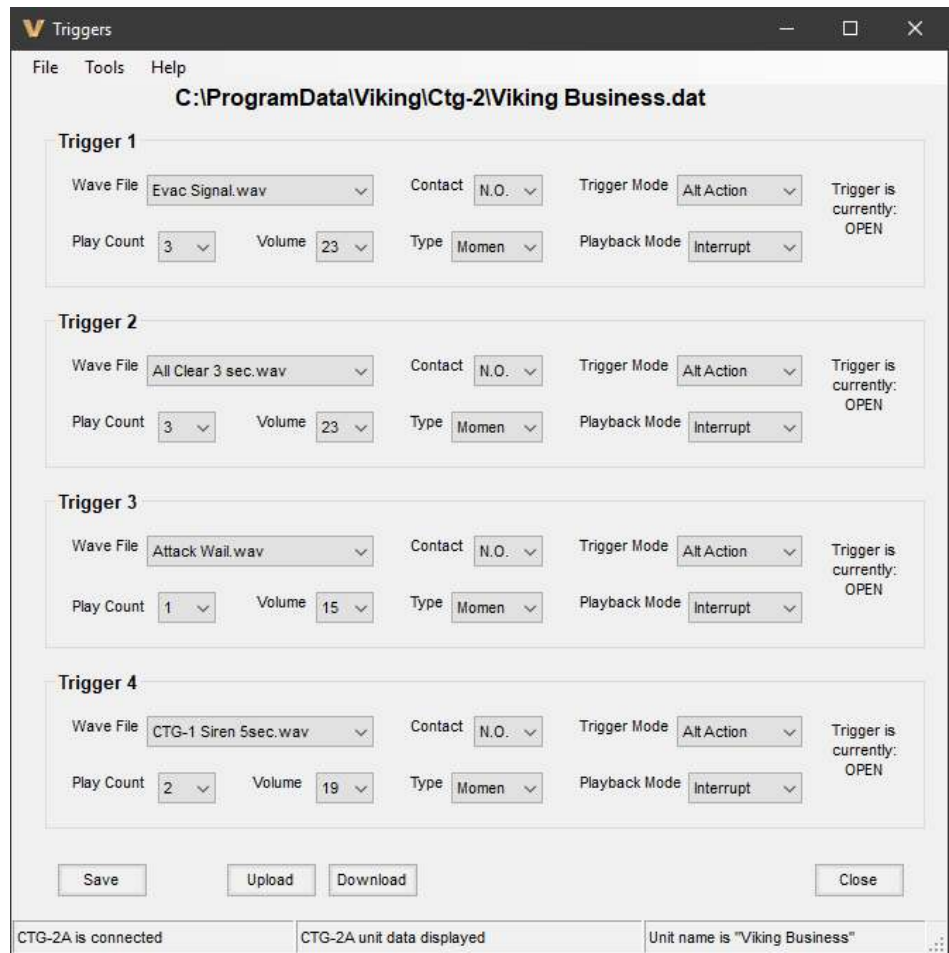

Troubleshooting Communication Errors

1. If you open the PC software with a **CTG-2A** connected, occasionally a communications error will occur between the PC and the **CTG-2A** and a message will pop up saying the **CTG-2A** is missing some of its wave files, when they are not missing. If you get this type of error message, close the software and re-open it.
2. A similar miscommunication can cause the Login prompt to appear repeatedly, if this happens, close the software and re-open it. If you are again prompted for the login, you can reset the **CTG-2A**'s login by turning DIP switch 2 to ON then back to OFF (see page 18).
3. If the **CTG-2A** displays “Pro” when the PC software is not open, momentarily power down the **CTG-2A** and the display should clear.
4. If you open the PC software and a message says: “error on directory position 15”, close the PC software and power down the **CTG-2A**. Reconnect power and open the PC software again.
5. Firewall issues: The following ports are used by the **CTG-2A** and must not be blocked or firewalled for it to function: TCP 80*, TCP 443*, TCP 9761*, UDP123*, UDP 6234 and UDP 30303.

*Can be changed in software.

Push Button Programming

The push buttons on the front of the **CTG-2A** are limited to allow you to program only the following functions: Set time, Set Schedule, Force a NTP Clock sync, Turn the unit ON (RUN) or OFF. See PC programming for all other functions.

MODE Switch: Press this to cycle through the following modes “RUN”, “SET TIME”, “SET SCHEDULE” and “ TIME SYNC”. LED’s to the left of the display will light indicating which mode the unit is in.

+/- TIME Switches

RUN Mode: Press the “-” button to place the unit in the OFF mode. Press the “+” button to place the unit in the RUN mode.

Note: *When the CTG-2A is in the OFF mode, programmed events will not be transmitted. Unit will display “OFF”, the internal clock will continue to run and the 4 trigger inputs will remain functional.*

SET TIME Mode: Use “+/-” buttons to increment or decrement clock time.

SET SCHEDULE Mode: Use “+/-” buttons to select a fixed schedule or Automatically Switch Schedules (CAL). **Note:** *If you select a specific schedule through the PC software or push button programming, the CTG-2A will only run that schedule and will not change schedules until another schedule or Automatically switch Schedules mode is set (any schedule change events are ignored).*

TIME SYNC Mode: Press the “+” button to initiate a “Time Sync” and download the current time and date. This process will take approximately 6 seconds in which time the unit will flash “Snc” on the clock display. The default time server is “0.viking.pool.ntp.org”. This is programmed on the “Clock” screen. Note: Unit must have an active internet connection or be programmed for a local time server for time sync to function.

If the **CTG-2A** was unable to sync, the display will flash “Snc”, the current time, then “Err”. If this happens, check to make sure the **CTG-2A** has a network connection and that UDP port 123 is not blocked by your company’s firewall. Then go into PC programming under “Clock” and verify the correct time server is configured.

Display	Description
cdS	Unit is in Automatically Switch Schedules Mode but is currently in “System Disable” (example: spring break, summer break, etc.)
CO 1-14	Unit is in Automatically Switch Schedules Mode and currently running schedule shown.
0 1-14	Unit is NOT in Automatically Switch Schedules Mode and will only run the schedule shown.
CAL	Displayed when setting unit in the Automatically Switch Schedules Mode.
Snc Err	Displayed when the CTG-2A is unable to synchronize with NTP server. See Time Sync Mode below.
CAL Err	Displayed when the CTG-2A has lost power for over 4 days and has dates or daylight savings time programmed. This can be corrected with a “Time Sync” (see below) or enter PC programming and reprogram the clock in the “Clock” screen (see page 15).
dS	Displayed when the CTG-2A is in the “System Disable” mode (see “System Disable” page 12).
OFF	Displayed when the CTG-2A is in the “Off” mode. In the “Off” mode, the CTG-2A will not play or activate any programmed events. Note: <i>The 4 trigger inputs will remain functional for emergency signaling, etc.</i>
Pro	Displayed when the CTG-2A is in “PC Programming”. In the “Pro” mode, the CTG-2A will not play or activate any programmed events. Note: <i>The 4 trigger inputs will remain functional for emergency signaling, etc.</i>
Snc	Displayed when the CTG-2A is in the “Time Sync” mode.

DIP Switches:

Clock Reset (DIP 1): To reset the **CTG-2A**’s clock, power down the **CTG-2A**, turn DIP switch 1 off for one second before turning it back on, then power the **CTG-2A** back up.

Network Reset (DIP 2): To reset the **CTG-2A**’s username and password, turn DIP switch 2 on momentarily before turning it back off. To reset the network settings, username and password, turn DIP switch 2 on for 5 seconds before turning it back off. Leaving DIP switch 2 on for more than 12 seconds resets the NTP Server and Unit Name as-well.

Operation

After all PC programming is completed, saved to the dat file and uploaded to the **CTG-2A**, you can now exit programming and place the unit in the “RUN” or “OFF” mode. To exit PC programming and place the unit in the RUN mode click on “RUN” in the “Event Programming” screen, select “Automatically Switch Schedules” (automatically switches schedules per Calendar programming) or select which specific “Schedule” you would like the **CTG-2A** to run. If you select a specific schedule the **CTG-2A** will only run that schedule and will not change schedules until reprogrammed. The **CTG-2A** will now display the current time with a flashing colon and light the “RUN” LED. When placed in the “RUN” mode the **CTG-2A** is now ready to play and/or activate the next scheduled event. **Note:** *Only one wave file event can be played per minute but the CTG-2A can change a schedule, play a wave file and activate the Aux relay at the same programmed time.*

To exit PC programming and place the unit in the “OFF” mode click on “Exit” in the “Event Programming” screen then click “NO”. This will close PC programming and place the **CTG-2A** in the “OFF” mode. The unit’s clock display will display “OFF”. With the **CTG-2A** in the “OFF” mode the unit will not play or activate any programmed events. The 4 trigger inputs will remain fully functional for emergency signaling, etc. The unit can be placed back into the “RUN” mode via Push Button programming or PC programming.

If you select a specific schedule through the PC software or push button programming, the **CTG-2A** will only run that schedule and will not change schedules until another schedule or Automatically Switch Schedules mode is set (any schedule change events are ignored).

Auxiliary Relay Operation

The auxiliary relay can be either timed or continuously activated through clock events. If the auxiliary relay is currently activated (because of an event) and AC power is lost even momentarily, the auxiliary relay will no longer be activated when power is restored. If this type of operation is not desirable, a UPS is recommended for the **CTG-2A** power.

If an auxiliary relay activation is missed while programming or due to power failure, connect with the **CTG-2A** and check the “Aux Relay On” checkbox on the “Run” screen when finished programming. If the “Aux Relay On” checkbox is already checked on the “Run” screen, the auxiliary relay was activated when you entered PC programming.

Compatible Products

Wireless Analog / Digital Clocks and Accessories

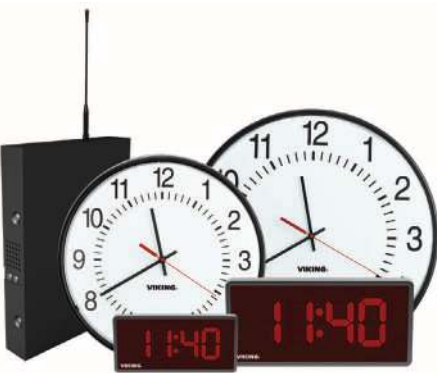

See DOD# 466 for more info

Viking's Wireless Clock System provides reliable, accurately synchronized clocks for your entire facility. Eliminating dedicated clock wiring can save you thousands of dollars on installation and also allows for easy retrofitting of an existing installation. While most wireless systems are limited to the range of the transmitter, Viking's system is not. Each clock acts as a Repeater (transceiver), meaning the secondary clocks both receive and retransmit the signal, maximizing signal transmission distances. The system is comprised of a **CTG-2A** master clock, a **CL-RFT** clock RF transmitter and Analog or Digital wireless clocks. Working on Viking's 915-928MHz frequency hopping technology eliminates interference with other wireless products and requires no FCC license, eliminating extraneous fees. The received signal remains strong even under the effects of noise, obstructions or long distances which tend to decrease the signal to noise ratio. Installation is a cinch for our wireless clocks, just insert the batteries or connect power and hang them. That's it.

Warranty

IF YOU HAVE A PROBLEM WITH A VIKING PRODUCT, CONTACT VIKING TECHNICAL SUPPORT: 715-386-8666

Our Technical Support Department is available for assistance Monday through Friday 8:00am to 5:00pm central time. So that we can give you better service, before you call please:

1. Know the model number, the serial number and what software version you have (see serial label).
2. Have the Product Manual in front of you.
3. It is best if you are on site.

RETURNING PRODUCT FOR REPAIR

The following procedure is for equipment that needs repair:

1. Customer must contact Viking's Technical Support Department at 715-386-8666 to obtain a Return Authorization (RA) number. The customer MUST have a complete description of the problem, with all pertinent information regarding the defect, such as options set, conditions, symptoms, methods to duplicate problem, frequency of failure, etc.
2. Packing: Return equipment in original box or in proper packing so that damage will not occur while in transit. The original product boxes are not designed for shipping - an overpack box is required to prevent damage in transit. Static sensitive equipment such as a circuit board should be in an anti-static bag, sandwiched between foam and individually boxed. All equipment should be wrapped to avoid packing material lodging in or sticking to the equipment. Include ALL parts of the equipment. C.O.D. or freight collect shipments cannot be accepted. Ship cartons prepaid to:

**VIKING ELECTRONICS
1531 INDUSTRIAL STREET
HUDSON, WI 54016**

3. Return shipping address: Be sure to include your return shipping address inside the box. We cannot ship to a PO Box.
4. RA number on carton: In large printing, write the RA number on the outside of each carton being returned.

RETURNING PRODUCT FOR EXCHANGE

The following procedure is for equipment that has failed out-of-box (within 10 days of purchase):

1. Customer must contact Viking's Technical Support at 715-386-8666 to determine possible causes for the problem. The customer MUST be able to step through recommended tests for diagnosis.
2. If the Technical Support Product Specialist determines that the equipment is defective based on the customer's input and troubleshooting, a Return Authorization (RA) number will be issued. This number is valid for fourteen (14) calendar days from the date of issue.
3. After obtaining the RA number, return the approved equipment to your distributor. Please reference the RA number on the paperwork being shipped back with the unit(s), and also the outside of the shipping box. The original product boxes are not designed for shipping - an overpack box is required to prevent damage in transit. Once your distributor receives the package, they will replace the product over the counter at no charge. The distributor will then return the product to Viking using the same RA number.
4. **The distributor will NOT exchange this product without first obtaining the RA number from you. If you haven't followed the steps listed in 1, 2 and 3, be aware that you will have to pay a restocking charge.**

TWO YEAR LIMITED WARRANTY

Viking warrants its products to be free from defects in the workmanship or materials, under normal use and service, for a period of two years from the date of purchase from any authorized Viking distributor. If at any time during the warranty period, the product is deemed defective or malfunctions, return the product to Viking Electronics, Inc., 1531 Industrial Street, Hudson, WI., 54016. Customer must contact Viking's Technical Support Department at 715-386-8666 to obtain a Return Authorization (R.A.) number.

This warranty does not cover any damage to the product due to lightning, over voltage, under voltage, accident, misuse, abuse, negligence or any damage caused by use of the product by the purchaser or others. This warranty does not cover non-EWP products that have been exposed to wet or corrosive environments. This warranty does not cover stainless steel surfaces that have not been properly maintained.

NO OTHER WARRANTIES. VIKING MAKES NO WARRANTIES RELATING TO ITS PRODUCTS OTHER THAN AS DESCRIBED ABOVE AND DISCLAIMS ANY EXPRESS OR IMPLIED WARRANTIES OR MERCHANTABILITY OR FITNESS FOR ANY PARTICULAR PURPOSE.

EXCLUSION OF CONSEQUENTIAL DAMAGES. VIKING SHALL NOT, UNDER ANY CIRCUMSTANCES, BE LIABLE TO PURCHASER, OR ANY OTHER PARTY, FOR CONSEQUENTIAL, INCIDENTAL, SPECIAL OR EXEMPLARY DAMAGES ARISING OUT OF OR RELATED TO THE SALE OR USE OF THE PRODUCT SOLD HEREUNDER.

EXCLUSIVE REMEDY AND LIMITATION OF LIABILITY. WHETHER IN AN ACTION BASED ON CONTRACT, TORT (INCLUDING NEGLIGENCE OR STRICT LIABILITY) OR ANY OTHER LEGAL THEORY, ANY LIABILITY OF VIKING SHALL BE LIMITED TO REPAIR OR REPLACEMENT OF THE PRODUCT, OR AT VIKING'S OPTION, REFUND OF THE PURCHASE PRICE AS THE EXCLUSIVE REMEDY AND ANY LIABILITY OF VIKING SHALL BE SO LIMITED.

IT IS EXPRESSLY UNDERSTOOD AND AGREED THAT EACH AND EVERY PROVISION OF THIS AGREEMENT WHICH PROVIDES FOR DISCLAIMER OF WARRANTIES, EXCLUSION OF CONSEQUENTIAL DAMAGES, AND EXCLUSIVE REMEDY AND LIMITATION OF LIABILITY, ARE SEVERABLE FROM ANY OTHER PROVISION AND EACH PROVISION IS A SEPARABLE AND INDEPENDENT ELEMENT OF RISK ALLOCATION AND IS INTENDED TO BE ENFORCED AS SUCH.

If trouble is experienced with the **CTG-2A**, for repair or warranty information, please contact:

Viking Electronics, Inc., 1531 Industrial Street, Hudson, WI 54016 715-386-8666

WHEN PROGRAMMING EMERGENCY NUMBERS AND (OR) MAKING TEST CALLS TO EMERGENCY NUMBERS:

Remain on the line and briefly explain to the dispatcher the reason for the call. Perform such tests in off-peak hours, such as early morning or late evenings.

PART 15 LIMITATIONS

This equipment has been tested and found to comply with the limits for a Class A digital device, pursuant to Part 15 of the FCC Rules. These limits are designed to provide reasonable protection against harmful interference when the equipment is operated in a commercial environment. This equipment generates, uses, and can radiate radio frequency energy and, if not installed and used in accordance with the instruction manual, may cause harmful interference to radio communications. Operation of this equipment in a residential area is likely to cause harmful interference in which case the user will be required to correct the interference at his own expense.

Product Support: 715-386-8666

Due to the dynamic nature of the product design, the information contained in this document is subject to change without notice. Viking Electronics, and its affiliates and/or subsidiaries assume no responsibility for errors and omissions contained in this information. Revisions of this document or new editions of it may be issued to incorporate such changes.