

EXT-1830

1.5" NPT Telescoping Extension – 18" to 30"

Product Features:

Works with VMP ceiling mounts that use or have been adapted to use 1.5" NPT pipe

Works with any manufacturer's ceiling mounts which use 1.5" NPT pipe

Adjustable from 18" to 30"

Black powder coat finish

Product Specifications:

(for Architects & Engineers)

The telescoping extension shall be the Video Mount Products (VMP) EXT-1830. The extension shall be made of 1.5" NPT pipe. The extension shall be capable of adjusting from 18" to 30". The extension shall have predrilled holes every inch. The extension shall be able to integrate with any manufacturer's mount which uses 1.5" NPT pipe.

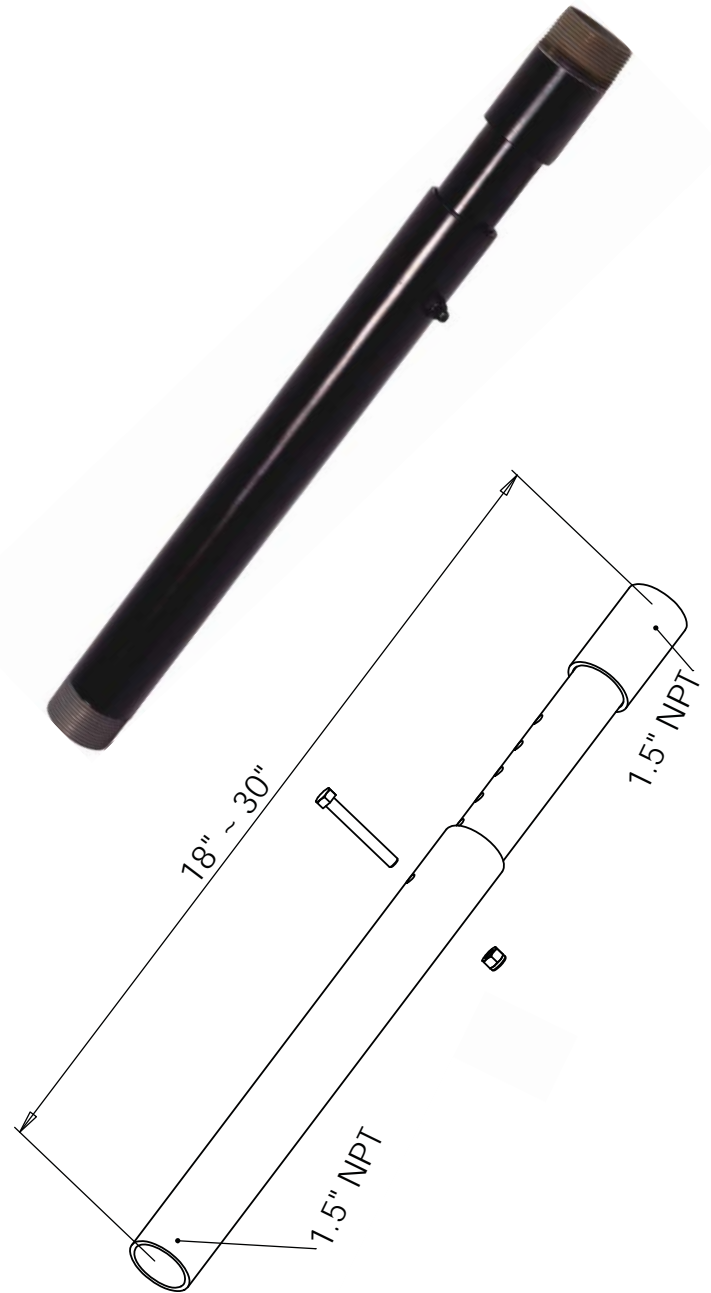

Video Mount Products

345 Log Canoe Circle

Stevensville, MD 21666

Toll Free: 877.281.2169

Telephone: 410.643.6390

Facsimile: 410.643.6615

www.videomount.com

VMP
VIDEO MOUNT PRODUCTS