

Flat-Field Mega-Pixel Lens Series

Flat-Field Mega-Pixel Lens

Flat-Field NIR Mega-Pixel Lens







Specifications and Lineup

Image	Full HD 5MP Flat-Field MegaPixel IR			Full HD 3MP Flat-Field MegaPixel IR			Full HD 3MP Flat-Field MegaPixel IR			Full HD 2MP Flat-Field MegaPixel IR	
											
Model	M118VM413IR	M118VG413IR	M118VP413IR	M13VM288IR	M13VG288IR	M13VP288IR	M13VG850IR	M13VP850IR	M13VG550IR		
Imager Size	1/1.8"	1/2"	1/3"	1/2.7"	1/3"	1/4"	1/2.7"	1/3"	1/4"	1/3" 1/4"	
Mount Type	C			CS			CS			CS	
Focal Length	4.0-13mm			2.8-8mm			8-50mm			5-50mm	
Aperture Range	F/1.5-Close			F/1.2-Close	F/1.2-360	F/1.2-Close	F/1.6-360	F/1.6-Close	F/1.6-360		
Zoom Ratio	x3.2			x2.8			x6.2			x10	
Field of View Angle (Horizontal X Vertical)	1 Wide	105.4° × 77.6°		1 Wide	124.3° × 65.2°		1 Wide	40.3° × 22.6°		1 Wide	53° × 40°
	1.8 Tele	33.0° × 24.8°		2.7 Tele	43.0° × 24.2°		2.7 Tele	6.6° × 3.8°		3 Tele	5.6° × 4.2°
	1 Wide	91.7° × 67.9°		1 Wide	100.1° × 72.9°		1 Wide	33.5° × 25.1°		1 Wide	40° × 30°
	2 Tele	29.0° × 21.8°		3 Tele	35.8° × 26.8°		3 Tele	5.6° × 4.2°		4 Tele	4.2° × 3.2°
Operation	Focus	Manual w/Lock		Manual w/Lock			Manual w/Lock			Manual w/Lock	
	Zoom	Manual w/Lock		Manual w/Lock			Manual w/Lock			Manual w/Lock	
	Iris	Manual w/Lock	DC Auto Iris	P-Iris*	Manual w/Lock	DC Auto Iris	P-Iris*	DC Auto Iris	P-Iris*	DC Auto Iris	
Focus Range	0.3m-∞			0.3m-∞			2.0m-∞			1.0m-∞	
Operating Temperature	-20 - +60°C			-20 - +60°C			-20 - +60°C			-20 - +60°C	

*Connecting the lens to a camera that does not support the P-Iris technology may cause malfunction. The lens cannot be connected to cameras that use DC auto iris or video auto iris lenses.

Image	HD Flat-Field MegaPixel		HD Flat-Field MegaPixel		HD Flat-Field MegaPixel		HD Flat-Field MegaPixel		
									
Model	M13VM246	M13VG246	M13VM308	M13VG308	M13VM550	M13VG550	M12VM412	M12VG412	
Imager Size	1/3"	1/4"	1/3"	1/4"	1/3"	1/4"	1/2"	1/3"	
Mount Type	CS		CS		CS		C		
Focal Length	2.4-6mm		3.0-8mm		5-50mm		4.0-12mm		
Aperture Range	F/1.2-Close	F/1.2-360	F/1.0-Close	F/1.0-360	F/1.4-Close	F/1.4-360	F/1.4-Close	F/1.4-360	
Zoom Ratio	x2.5		x2.6		x10		x3		
Field of View Angle (Horizontal X Vertical)	1 Wide	111.3° × 83.5°		1 Wide	92.5° × 68.2°		1 Wide	53.8° × 40.3°	
	3 Tele	47.1° × 35.4°		3 Tele	35.4° × 26.5°		3 Tele	5.5° × 4.2°	
	1 Wide	83.5° × 62.6°		1 Wide	68.2° × 50.6°		1 Wide	40.3° × 30.2°	
	4 Tele	35.4° × 26.6°		4 Tele	26.5° × 19.9°		4 Tele	4.2° × 3.1°	
Operation	Focus	Manual w/Lock		Manual w/Lock		Manual w/Lock		Manual w/Lock	
	Zoom	Manual w/Lock		Manual w/Lock		Manual w/Lock		Manual w/Lock	
	Iris	Manual w/Lock	DC Auto Iris	Manual w/Lock	DC Auto Iris	Manual w/Lock	DC Auto Iris	Manual w/Lock	DC Auto Iris
Focus Range	0.3m-∞		0.3m-∞		1.0m-∞		0.3m-∞		
Operating Temperature	-20 - +60°C		-20 - +60°C		-20 - +60°C		-20 - +60°C		

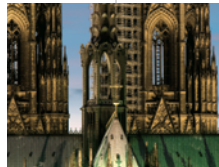
Full HD 5MP IR		M118VM413IR / M118VG413IR / M118VP413IR			
Full HD 3MP IR		M13VM288IR / M13VG288IR / M13VP288IR			
Full HD 2MP IR		M13VG550IR			
Full HD 3MP IR		M13VG850IR / M13VP850IR			
HD	M13VM246 / M13VG246				
HD	M13VM308 / M13VG308				
HD	M13VM550 / M13VG550				
HD	M12VM412 / M12VG412				
					
2.4mm	2.8mm	5mm	8mm	12mm	50mm

*Angle of view images are illustrative examples.

Delivering Uniformly High-Resolution Image from Corner to Corner

The Tamron Flat-Field Mega-Pixel Lens Series delivers Mega-pixel image quality not only in the center but also in the corners of the image fields, providing the mega-pixel resolution quality needed for image cropping and enlarging of image, irrespective of the location of the subject on the screen. This ensures that subject faces and other relevant information can be clearly identified and distinguished, making the Tamron Flat-Field Mega-Pixel Lenses an ideal solution for high-resolution network surveillance applications. In fact all lenses of the Tamron Mega-Pixel Lens Series lineup deliver Flat-Field Mega-Pixel resolution.

Screen-Wide Consistent High-Resolution and High-Contrast Image Quality

Wide Angle

Normal Lens

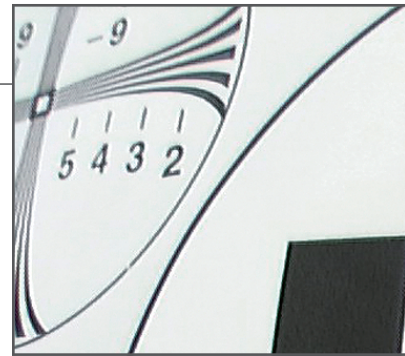
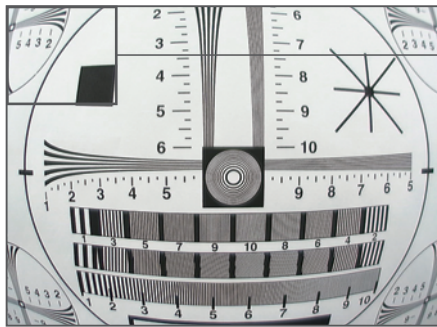

Tamron Mega-Pixel Lens

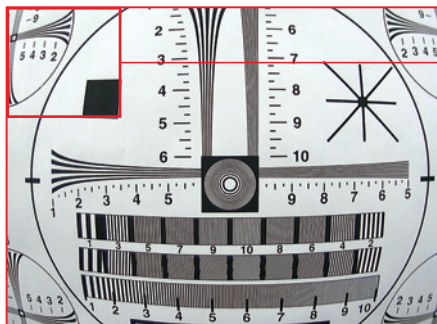

Tele Angle

Normal Lens

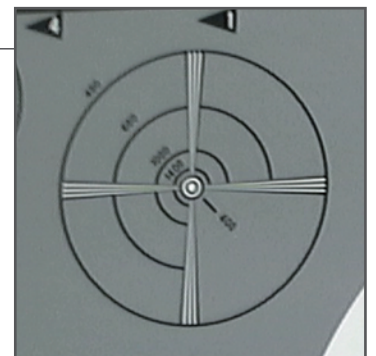
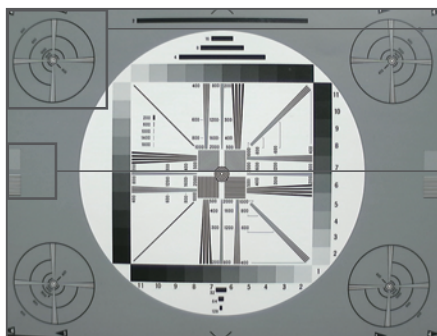

Tamron Mega-Pixel Lens

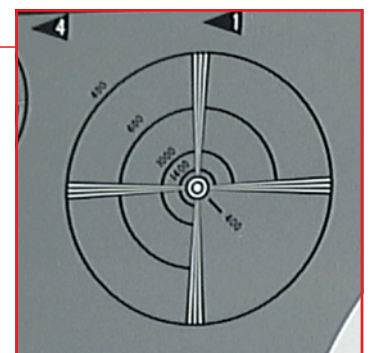
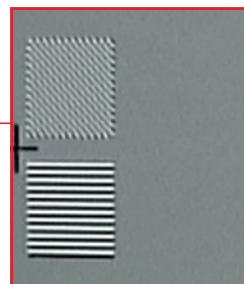
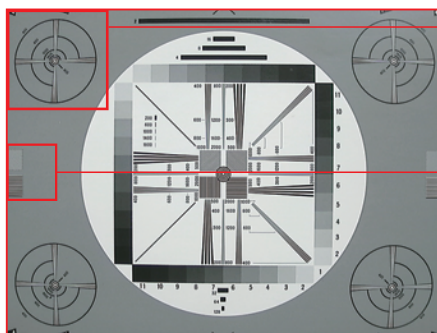

* Image taken at maximum aperture.

** Images shown are all shot using actual mega-pixel cameras and IP/CCTV lenses.

Key Mega-Pixel Technologies

Key Technologies Supporting with Mega-Pixel Compatibility

Each lens in Tamron's Mega-Pixel Vari-Focal Lens Series uses Aspherical elements to minimize optical aberrations and ensure high optical quality while maintaining a compact form. Employing innovative optical technologies, these lenses deliver high-resolution and high-contrast images that are sharp from the center to corner of the image field, and represent the ideal solution for application that uses high-quality mega-pixel cameras.

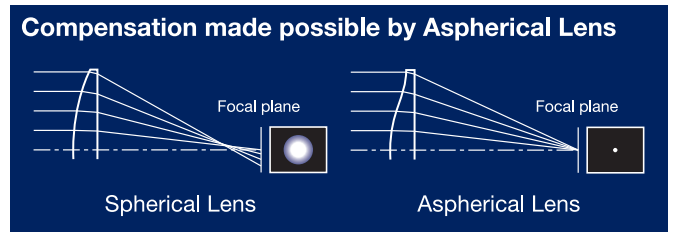

Wide Dynamic Range < M13VM308 / M13VG308 >

The fast aperture of F/1.0 makes it possible to obtain vivid color images even in dim lighting conditions such as dark rooms and corridors, or in the early morning or evening hours when the ambient light would ordinarily be insufficient to capture high-quality images. A fast lens is able to gather a large amount of light, thereby enhancing the sensitivity of the camera.



■ F/1.4

■ F/1.0

F/1.0 lens has two times light gathering power compared to F/1.4 making a 1 lux camera sensitivity into a 0.5 lux sensitivity.

Multiple-Layer Coatings

Multi-coating is applied to internal and external lens surfaces to minimize ghosting and flare in backlit situations. The result is consistently sharp contrast and excellent image quality even under unfavorable lighting conditions.



Supporting up to 1/2.7" Sensors

< M13VM288IR / M13VG288IR / M13VP288IR / M13VG850IR / M13VP850IR >

The large image circle makes it possible to match with 1/2.7", as well as 1/2.8" and 1/3" sensor sizes. Due to variance in such sensor sizes, it was essential to incorporate such design.

P-Iris < M118VP413IR / M13VP288IR / M13VP850IR >

By using a stepping motor to control the iris, these lenses are capable of adjusting the aperture at a position that does not cause diffraction, enabling an appropriate level of exposure by utilizing the camera shutter speed.* The result is that high-quality, high-contrast images can be recorded, even in bright outdoor areas. This fine tuning control will allow the user to acquire the best image quality delivering good depth of field at most installations.

* Connecting the lens to a camera that does not support the P-Iris technology may cause malfunction.
The lens cannot be connected to cameras that use DC auto iris or video auto iris lenses

Compact Design

Mega-pixel resolution is achieved while maintaining the compactness of conventional lenses.

Slip-Mount Mechanism

Each lens is equipped with a slip-mount mechanism that allows rotational adjustment of the lens after it is mounted on a camera. This allows optimal positioning of the auto-iris actuator and cable during installation.

* Except for M118VM413IR / M118VG413IR / M118VP413IR

Locking Mechanism for Each Control Ring

Each control ring for zoom, focus, and iris size* can be independently locked to prevent setting displacement after installation.
(*Manual iris only)

Large Focus Rotation Angle

The rotation angle of the focus ring has been increased to achieve easier and more precise focus adjustment for mega-pixel cameras.



Precision Manufacturing

Each component in our Flat-Field Mega-Pixel Lenses are produced and assembled using the most advanced precision manufacturing techniques to prevent image degradation due to local blur and focus shift.

Flat-Field NIR (Near-IR) Mega-Pixel Lenses

- 3MP **M118VM413IR/M118VG413IR/M118VP413IR 4.0-13mm F/1.5** Full HD IR
M13VM288IR/M13VG288IR/M13VP288IR 2.8-8mm F/1.2 Full HD IR
M13VG850IR/M13VP850IR 8-50mm F/1.6 Full HD IR
- 2MP **M13VG550IR 5-50mm F/1.6** Full HD IR

3-Mega-Pixel Quality that Meets or Exceeds Full HD 1080P in Both the Visible and NIR Spectrums

Two Lenses Cover 2.8mm to 50mm

The lenses cover wide angle 2.8mm to telephoto 50mm, which means that most applications can be covered by these two lenses. The horizontal angle of view is 124.3 degree at wide and 6.6 degree at telephoto end. (1/2.7" sensor)

Fast F Number

The full open aperture of the standard lens is F/1.2 and for the telephoto lens F/1.6. This will enable the lens to be used under low light situation yet delivering the mega-pixel resolution.

Compatible with Current Camera Design

Internal components in the vicinity of the imager are designed to minimize protrusion from the lens mount face for full compatibility with most surveillance cameras in the market.

Superb Picture Quality

Designed to minimize color aberrations, ghost, and flare for top picture quality.

3-Mega-Pixel / Full HD Resolution for 24/7 Surveillance

NIR radiation refracts differently from visible light, causing blurring in an image captured in the NIR spectrum. Tamron NIR Mega-Pixel Lenses utilize cutting-edge optical design technology and advanced low dispersion glass to converge the focal points of visible light and NIR radiation, providing 3-mega-pixel image quality 24-hours a day.

Exceptional Image Quality in the Visible and NIR Spectrums

With conventional lenses, image focus shift will occur in the surveillance camera video footage, shot under the NIR illumination. NIR wavelength will be refracted differently from the visible light, which results in out of focus image when switching to night mode. The Tamron NIR Mega-Pixel Lens Series features the latest optical design incorporating the low dispersion glass, Aspherical elements and special coating technology, which resolves the focus shift issue. As a result, the lens will provide clear image of 3-mega-pixel even in black and white mode enabling the true mega-pixel 24-hours surveillance regardless of the lighting condition.

Comparison of a Visible Light Lens and an NIR Lens

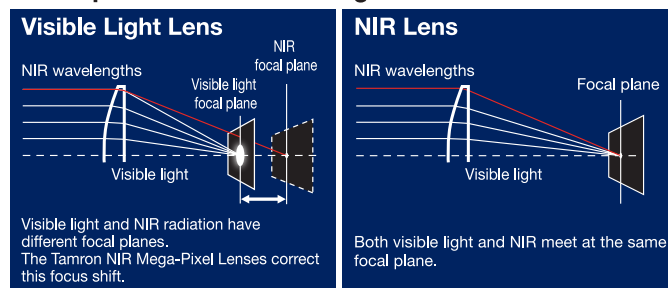

Visible Light (Color Mode)



NIR Light (B/W Mode)

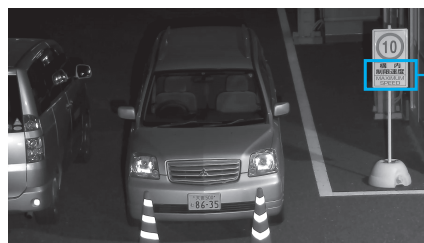

Dimensions

M118VM413IR

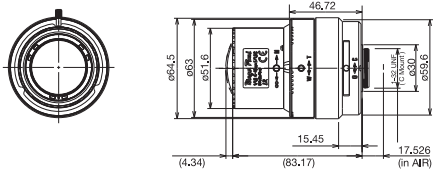

M13VG850IR

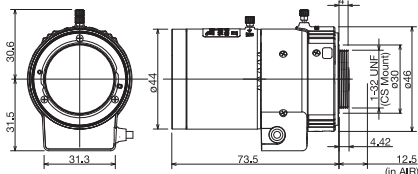

M13VG550

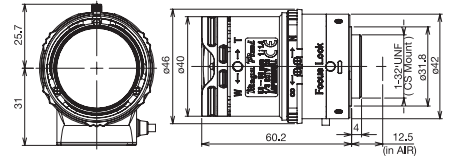

M118VG413IR

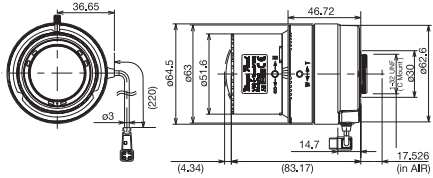

M13VP850IR

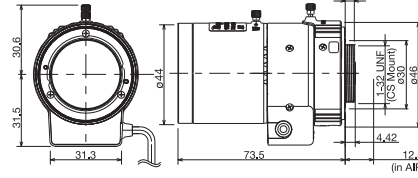

M13VM308

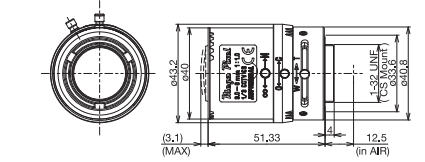

M118VP413IR

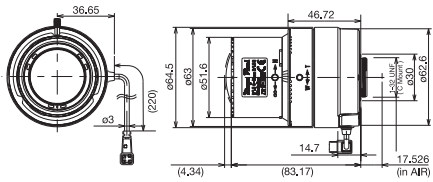

M13VG550IR

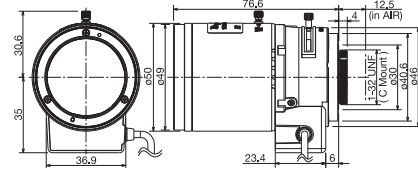

M13VG308

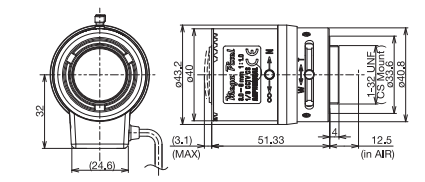

M13VM288IR

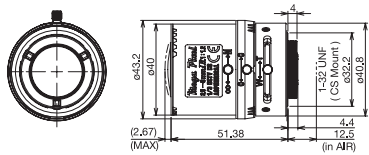

M13VM246

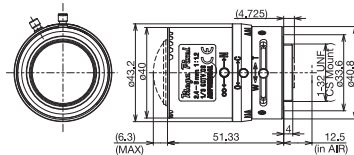

M12VM412

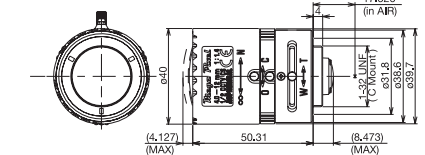

M13VG288IR

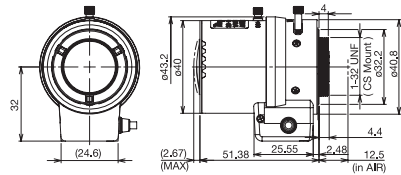

M13VG246

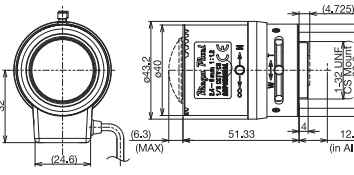

M12VG412

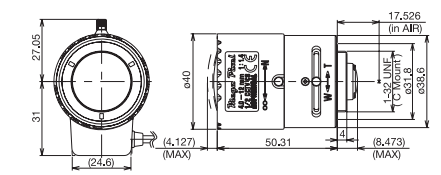

M13VP288IR

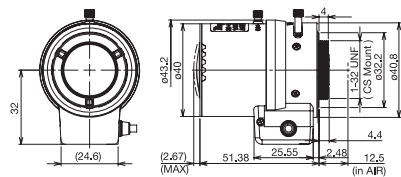

M13VM550

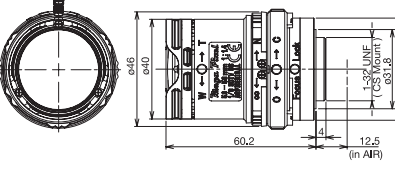

Caution: Please read the instruction manual carefully before using the lens.

TAMRON

Manufacturer of precise and sophisticated optical products for a broad range of industries.

TAMRON CO., LTD. <http://www.tamron.biz/>

1385, Hasunuma, Minuma-ku, Saitama-shi, Saitama 337-8556 JAPAN
Tel: +81-48-684-9129 Fax: +81-48-683-8594



Management on Quality and Environment

Tamron is certified with international standards: ISO 9001 for quality and ISO14001 for environmental management at its headquarters, domestic sales offices, China plant as well as three production facilities in Aomori, Japan, and is fully committed to striving for continued and sustainable improvement at all levels and facets of its business operations.

