

# Commercial Audio Guide

Whether you are installing speakers in an office, a restaurant, a house of worship, an airport, a school, or some other commercial/government/educational operation, the fundamentals of each job are the same. Each installation centers around an amplifier. The amplifier will take audio signals from a source, and send the signal and power to the speakers to get the messages/music/alarms across.



## What Is a 70 Volt Sound System & What Is It Used For?

A 70 Volt Sound System is comprised of amplifiers, speakers with transformers, microphones, volume controls, a telephone system interface and an assortment of wires used as connections. It is generally used for commercial sound applications where there is a need for electronically amplifying and distributing sound for the functions of paging, playing music and/or pre-recorded messages to a commercial environment.

## What Are The Components That Make Up a 70 Volt Sound System?

**Centralized Amplifier:** The central unit of a 70 Volt System is the amplifier that boosts the sound signal to be distributed to pre-established speakers or paging horn loudspeakers. There are power amplifiers, which are rack-mountable and have no external controls, and packaged amplifiers, which have pre-amp features such as volume controls, bass/treble controls, etc., that are built into the amplifier; making it a pre-amp and power amp all in one unit.

Amplifiers have many diverse features and input and output connections. They can feature XLR MIC Connectors or MIC terminal strip connections, auxiliary/RCA inputs for music sources, and 600 Ohm telephone inputs.

Most commercial amplifiers have speaker outputs for 4/8/16 Ohms and 70V systems. Most Speco Technologies amplifiers offer a 'Music-on-hold' output feature to allow customers on hold to hear music or prerecorded advertising.

**Speakers:** There are several different types of speakers including in-ceiling, in-wall, baffle and flush-mount cone speakers or horn loudspeakers.

Optimal speaker selection for each installation depends on the application where the speaker is being used. It can also depend upon the size of the area needed to be covered, the ambient noise level of the environment, whether the speaker will be used for foreground/background music or voice, and whether the speaker will be used indoors or outdoors.

For 70 Volt Systems in commercial applications, the speakers must have a transformer mounted on it to be used.

**Transformers:** Transformers that are used on 70 Volt System speakers are step-down transformers that convert the high-voltage/low-current coming from the amplifier to the low-voltage/high-current signal going to the speaker.

A transformer most often has multiple wattage taps that allow each speaker to be individually set as to how much wattage will enter the speaker and how loud each speaker will be. Transformers can be sold individually to be mounted on a speaker or pre-mounted on a speaker.

**Phone System Interface Device:** These systems are used to connect a phone system to the speaker system via an amplifier for paging purposes.

**Microphones:** Located in the front end of the system, they will receive the delivered sound. Microphones are typically low impedance devices that require a shielded cable so as to not interfere with the amplifier or speaker wires.

**Wires:** Generally, speaker wire is determined by the length of the run and wattage utilized: For wire runs less than 50 ft. and 50 Watts of power or less use 16 gauge wire. For wire runs more than 50 ft. or over 50 Watts of power use 14 gauge wire.

**Volume Controls/Attenuators:** Allow adjustment of volume to speakers.

## What Are The Benefits of Using a 70 Volt Sound System?

A 70 Volt System uses a basis of high voltage to result in a lower current when distributing power to a sound system. Power equals voltage times current, thus a higher voltage will result in a lower current needed to arrive at a desired power load. By not having excessive, wasted current, **long runs of wire can be prevented from overheating.** This makes 70 Volt Systems very energy efficient. Many municipalities in America actually require the use of 25 Volt transformers because certain electrical codes will classify a 25 Volt system as low voltage, thus making it safer.

Generally speaking, 70 Volt Systems are much more **cost efficient** than an 8 Ohm speaker system when dealing with volume installation of speakers.

70 Volt Systems are **easier to design** than 8 Ohm speaker systems. The impedance does not have to be matched throughout the 70 Volt system as it would on an 8 Ohm based system.

70 Volt Systems can have their speakers **daisy chained** in parallel together without worry. Because 70 Volt speakers come with transformers, **impedance is not an issue** unless an excessive amount of speakers are going to be installed together. It is recommended to use multiple wire runs back to the amplifier as opposed to a single run. This will reduce location problems that occur and make it easier to find by isolating it on individual small speaker runs.

An easy calculation is all that is needed in determining the amount of wattage needed by your amplifier. Take the total wattage requirement of the 70 Volt speakers, or "load", include a 20% safety buffer to the upside and you will obtain the minimum RMS wattage.

70 Volt Systems allow the volume of each individual speaker in a specific area to be set using wattage taps. The higher the wattage taps are set on individual speakers, the more power the speaker consumes, the louder the speaker will be.

The speaker transformer serves as a safeguard to make sure individual speakers are not damaged by excessive wattage.

## Designing a 70 Volt System: Which Type of 70V Speaker Should I Use?

**In-Ceiling Speakers:** Best utilized in 8, 10 & 12 ft. drop ceilings in professional environments with low noise levels. Great for background music and/or paging. Ceiling support brackets should be used with in-ceiling speakers.

**Wall Baffle or Wall Mount Speakers:** Best utilized when the ceiling's height is prohibitive to speaker placement and/or speakers can not be mounted on the ceiling at all.

**P.A. Horns:** Horns are usually utilized in loud environments when distinct, and powerful paging messages are needed or when large areas must be covered. In addition, most P.A. Horns are weather-resistant and are used for outdoor applications such as loading docks and sports fields.

## How Many Speakers Should I Use? Determining Proper Use Quantity For In-Ceiling Speakers:

The industry standard for calculating the proper amount of in-ceiling speakers for a specific area is to should have twice the space from the floor to the ceiling between the placement of each speaker on the ceiling, as shown in **Diagram 1:**

### Ceiling Speakers Should be Spaced Apart at Twice the Space of the Ceiling Height

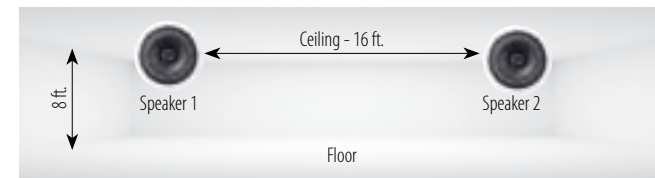

For example, if your installation involves an 8 foot ceiling, then the speakers should be placed 16 feet apart on a square footage basis which equals 256 ft. of ceiling area covered. The square area coverage chart (below) shows specific ceiling heights.

### Speaker Square Footage Coverage for Ceiling Heights

Ceiling Height	Speaker Spacing (ceiling height x2)	Square Feet Coverage per Speaker
8 ft.	16 ft.	16 x 16 = 256 ft.
10 ft.	20 ft.	16 x 16 = 400 ft.
12 ft.	24 ft.	24 x 24 = 576 ft.

You will notice, lowering the ceiling height results in the less square footage coverage per speaker, or the more speakers you will need. This is due to less downward space for sound dispersion before it reaches the listener. The following page contains a reference chart for determining the correct number of speakers needed for a specific area to assure proper dispersion of sound.

## Correct Number of In-Ceiling Speakers Needed for Proper Sound Dispersion in Room Areas

		Length of Installment Room																																																									
		10	15	20	25	30	35	40	50	60	70	80	90	100	110	120	130	140	150																																								
Width of Installment Room	10	8' Ceilings	1	1	1	2	2	2	3	4	4	5	6	6	7	8	8	9	9	10' Ceilings	1	1	1	1	2	2	2	3	3	4	4	5	5	6	7	7	8	12" Ceilings	1	1	1	1	1	2	2	2	2	3	3	4	4	5	5	6	6	6			
	15	8' Ceilings	1	1	1	2	2	2	3	4	4	5	6	6	7	8	8	9	9	10' Ceilings	1	1	1	1	2	2	2	3	3	4	4	5	5	6	6	7	7	8	12" Ceilings	1	1	1	1	1	2	2	2	2	3	3	4	4	5	5	6	6	6		
	20	8' Ceilings	1	1	2	2	2	3	3	4	5	6	6	7	8	9	10	10	11	12	10' Ceilings	1	1	1	1	2	2	2	3	3	4	4	5	5	6	6	7	7	8	12" Ceilings	1	1	1	1	1	2	2	2	2	3	3	4	4	4	4	5	5	5	
	25	8' Ceilings	2	2	2	3	3	4	4	5	6	7	8	9	10	11	12	13	14	15	10' Ceilings	1	1	1	2	2	2	3	3	4	4	5	6	6	7	8	8	9	9	12" Ceilings	1	1	1	1	1	2	2	2	3	3	3	4	4	4	5	5	6	6	7
	30	8' Ceilings	2	2	2	3	4	4	5	6	7	8	10	11	12	13	14	15	17	18	10' Ceilings	2	2	2	2	2	3	3	4	5	5	6	7	8	8	9	10	11	11	12" Ceilings	1	1	1	1	2	2	2	3	3	4	4	5	5	6	6	7	7	8	
	35	8' Ceilings	2	2	3	4	4	5	6	7	8	10	11	13	14	15	17	18	20	21	10' Ceilings	2	2	2	2	3	3	4	5	6	7	8	9	10	11	11	12	13	12" Ceilings	2	2	2	2	2	2	3	4	4	5	5	6	7	7	8	9	9			
	40	8' Ceilings	2	2	3	4	5	6	6	8	9	11	13	14	16	17	19	20	22	24	10' Ceilings	2	2	2	3	3	4	4	5	6	7	8	9	10	11	12	13	14	15	12" Ceilings	2	2	2	2	2	2	3	3	4	5	6	6	7	8	8	9	10	10	
	50	8' Ceilings	3	3	4	5	6	7	8	10	12	14	16	18	20	22	24	26	28	29	10' Ceilings	3	3	3	3	4	4	5	6	8	9	10	11	13	14	15	16	18	19	12" Ceilings	2	1	2	2	3	3	3	4	5	6	7	8	9	10	10	11	12	13	
	60	8' Ceilings	4	4	5	6	7	8	9	12	14	17	19	21	24	26	28	31	33	35	10' Ceilings	3	3	3	4	5	5	6	8	9	11	12	14	15	17	18	20	21	23	12" Ceilings	2	2	2	3	3	4	4	5	6	7	8	9	10	11	13	14	15	16	
	70	8' Ceilings	4	4	6	7	8	10	11	14	17	19	22	25	27	30	33	36	39	41	10' Ceilings	4	4	4	4	5	6	7	9	11	12	14	16	18	19	21	23	25	26	12" Ceilings	3	3	3	3	4	4	5	6	7	9	10	11	12	13	15	16	17	18	
	80	8' Ceilings	5	5	6	8	10	11	13	16	19	22	25	28	31	35	38	41	44	47	10' Ceilings	4	4	4	5	6	7	8	10	12	14	16	18	20	22	24	26	28	30	12" Ceilings	3	3	3	3	4	4	5	6	7	8	10	11	13	14	15	17	18	19	21
	90	8' Ceilings	6	6	7	9	11	13	14	18	21	25	28	32	35	39	42	46	49	53	10' Ceilings	5	5	5	6	7	8	9	11	14	16	18	20	23	25	27	29	32	34	12" Ceilings	4	4	4	4	5	5	6	8	9	11	13	14	16	17	19	20	22	23	
	100	8' Ceilings	6	6	8	10	12	14	16	20	24	27	31	35	39	43	47	51	55	59	10' Ceilings	5	5	5	6	8	9	10	13	15	18	20	23	25	28	30	33	35	38	12" Ceilings	4	4	4	4	5	6	7	9	10	12	14	16	17	19	21	23	24	26	
	110	8' Ceilings	7	7	9	11	13	15	17	22	26	30	35	39	43	47	52	56	60	65	10' Ceilings	6	6	6	7	8	10	11	14	17	19	22	25	28	30	33	36	39	42	12" Ceilings	5	5	4	5	6	7	8	10	11	13	15	17	19	21	23	25	27	29	
	120	8' Ceilings	8	8	10	12	14	17	19	24	28	33	38	42	47	52	56	61	66	70	10' Ceilings	6	6	6	8	9	11	12	15	18	21	24	27	30	33	36	39	42	45	12" Ceilings	5	5	4	5	6	7	8	10	13	15	17	19	21	23	25	27	29	31	
	130	8' Ceilings	8	8	10	13	15	18	20	26	31	36	41	46	51	56	61	66	72	78	10' Ceilings	7	7	7	8	10	11	13	16	20	23	26	29	33	36	39	42	46	49	12" Ceilings	5	5	5	6	7	8	9	11	14	16	18	20	23	25	27	30	32	34	
	140	8' Ceilings	9	9	11	14	17	20	22	28	33	39	44	49	55	60	66	72	77	82	10' Ceilings	7	7	7	9	11	12	14	18	21	25	28	32	35	39	42	46	49	53	12" Ceilings	6	6	5	6	7	9	10	12	15	17	19	22	24	27	29	32	34	37	
	150	8' Ceilings	9	9	12	15	18	21	24	29	35	41	47	53	59	65	70	76	82	88	10' Ceilings	8	8	8	9	11	13	15	19	23	26	30	34	38	41	45	49	53	56	12" Ceilings	6	6	5	7	8	9	10	13	16	18	21	23	26	29	31	34	37	39	

# Commercial Audio Overview

Once the proper quantities of speakers are determined, they should be set in the ceiling with an alternating pattern as shown in Diagram 2:

Diagram 2: Ceiling Speaker Layout on Ceiling

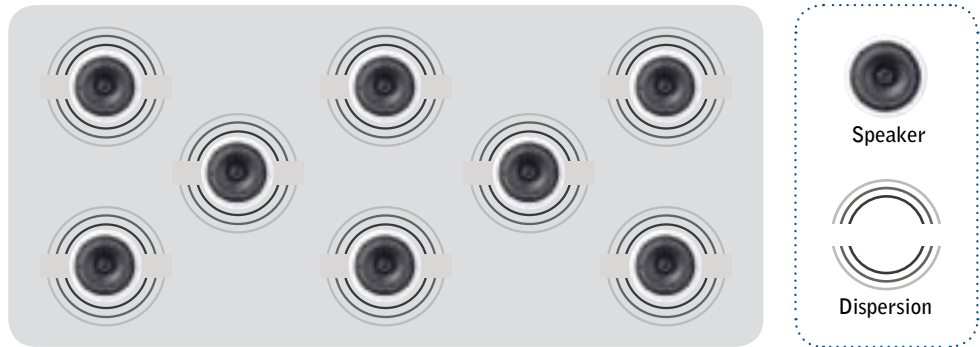

## Determining Proper Quantity of Wall Baffle Speakers:

The amount of Wall Baffle Speakers needed for an installation is calculated by taking the square footage of the area that needs coverage and dividing it by 600 square feet:

$$\text{Area of Square Footage Required} \div \text{Divided by \%} \text{ 600 Square Feet} = \text{Number of Wall Baffle Speakers Required}$$

600 ft. is an average estimate and is arrived at, by taking the usual side sound dispersement of a wall baffle speaker, (10 ft. to each side) while taking into consideration the usual sound projection outward (30 ft. outward) as detailed by Diagram 3:

Diagram 3: Wall Baffle Speaker Dispersement View from Ceiling

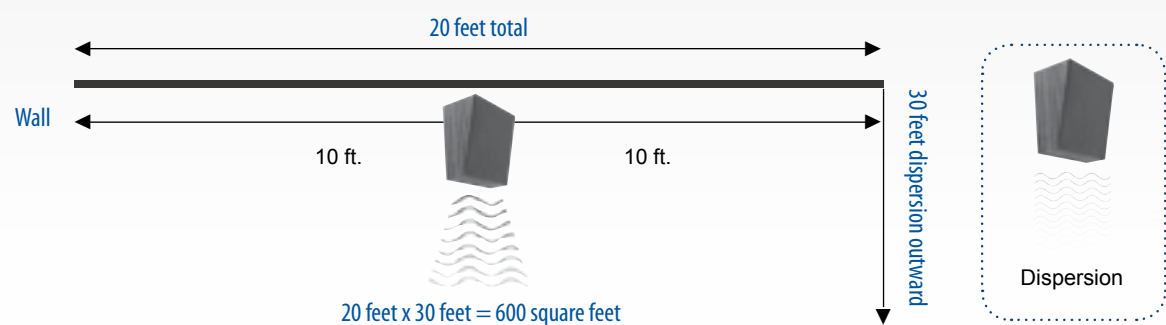

Wall Baffle Speakers should, whenever possible, be pointed in the same direction. It is very important that wall baffle speakers should not be positioned directly across from each other on opposing walls when covering a large area of space as shown in Diagram 4:

Diagram 4: Correct and Incorrect Placement of Wall Baffle Speakers

### A) Correct Wall Baffle Speaker Placement (view from ceiling)

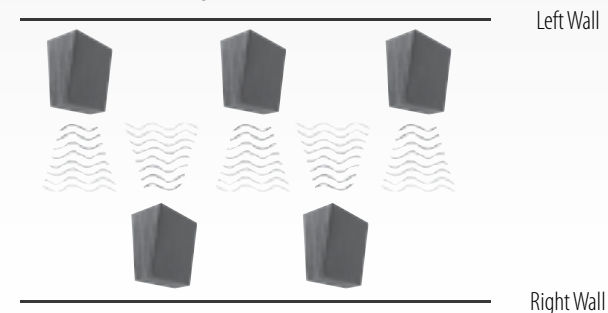

In scenario A there is proper dispersion and correct alignment.

### B) Wrong Wall Baffle Speaker Placement (view from ceiling)

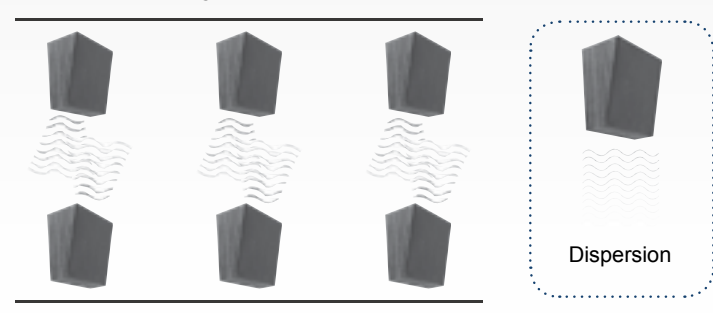

In scenario B there is an overlap of sound dispersion and distortion.

# Commercial Audio Overview

## Determining Proper Quantity Use For P.A. Horn Speakers:

The correct number of P.A. Horn Speakers can be determined by cross-referencing the square footage requirement and the type of noise environment. See chart below.

Desired Square Footage of Coverage

Environment	dB Class	Example	1	2	5	10	15	20	25	30	35	40	45	50	55	60	65	70	75	80	85	90	95	100	125	150	200	225	250	300
Quiet Areas	<70 dB	Restaurant Department Store	1	1	1	3	4	5	6	8	9	10	11	13	14	15	16	18	19	20	21	23	24	25	31	38	50	56	63	75
Noisy Areas	71-85 dB	Factory Assembly Line	1	1	2	4	6	8	10	12	14	16	18	20	22	24	26	28	30	32	34	36	38	40	50	60	80	90	100	120
Extremely Noisy Areas	>85 dB	Printing Press Metal Shop	1	2	4	8	13	17	21	25	29	33	38	42	46	50	54	58	63	67	71	75	79	83	104	125	167	188	208	250

P.A. Horns should be placed at a height of 15 feet and positioned at a 60 degree angle towards the ground. P.A. Horns should NEVER be positioned facing each other. When multiple P.A. Horns are needed in a line, what is known as a "diamond pattern" should be used as shown in Diagram 5:

Diagram 5: Proper Placement of P.A. Horns in "Diamond Pattern"

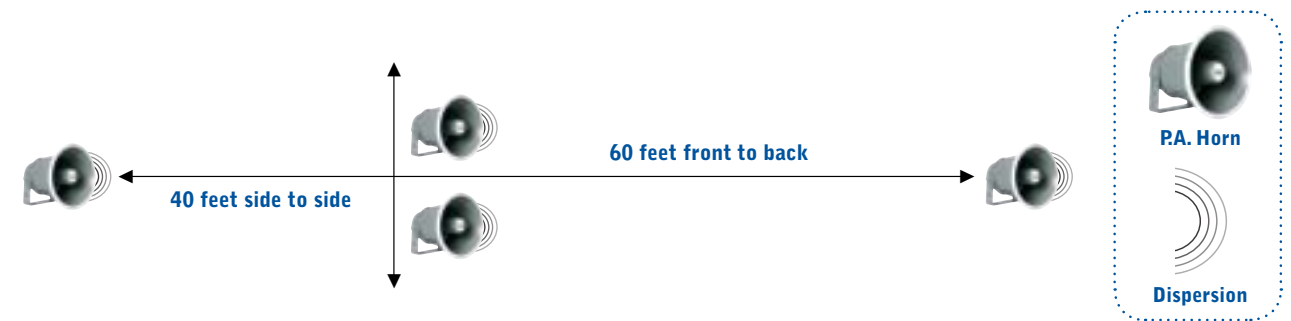

## What Is The Purpose of a 70V Transformer on a Speaker?

A 70V transformer protects the speaker and only allows a certain wattage to pass through the transformer to activate the speaker depending on the sound requirement. The higher the wattage tap is set or wired, the louder the speaker will be. In addition, this transformer based system is current efficient by protecting the system from getting overheated from wasted power. Finally, a 70V transformer based system only requires the installer to make a quick calculation to obtain the required wattage needed for the system. Each speaker in the system is individually set at a certain tap. The wattage calculation requires adding all the tap requirements and then adding an increase of 20% as a safety buffer.

## How Do I Wire a 70V Speaker?

Wiring a speaker with a 70 Volt transformer involves finding the correct colored wire extending from the transformer that corresponds with the desired wattage tap. Each colored wire's individual wattage tap should be marked on the transformer. Once the proper wire is found, connect it to the positive wire running from the amplifier. Then find the common wire extending from the transformer, usually black, and connect it with a wire running back towards the amplifier.

Some speakers have a transformer dial for selecting a desired wattage. This makes setup very easy by already providing one positive wire and one common wire for connections. All that's needed is to simply turn the transformer dial to the desired watt setting.



70V Transformer (T70255)



Transformer Dial



## Which Wattage Tap Should I Set My Horn or Speaker To?

The chart to the right shows a basic guideline for wattage tap setting. This is simply for general reference. Each job must be looked at individually as there are many factors that go into determining the best wattage tap settings.

Noise Level	Decibel	Environment	Wattage Tap*
Low	55dB-64dB	Corporate Office	0.25-2.5
		Doctor's Office	0.5
		Classroom	0.5-5
		Convenience Store	1
		Department Store	1-2.5
Medium	65dB-74dB	Restaurant	2
		Warehouse	2-10
		Hospital	2-5
		Supermarket	2-5
High	75dB-84dB	Bar	5-20
		Factory	7.5-40
		Assembly Line	15-50
Maximum	85dB+	Printing Press	30+
		Metal Shop	40+

\*taps vary depending on ceiling height and ambient noise

## How Do I Wire a Commercial Run of Speakers?

Commercial Speakers should be wired in a "PARALLEL RUN", meaning the positive outbound connection of the amplifier or receiver should run to the positive terminal of the first speaker. Then from that positive terminal the wiring should proceed to the next speaker's positive terminal as detailed in Diagram 5 below. The return wiring from each common terminal goes to the next speaker on the return run's common terminal and finishes at the amplifier/receiver.

## Diagram 6: Wiring Speakers in Parallel

Large runs with many speakers should be broken down into several smaller runs coming from the amplifier. If one speaker stops working it is easier to locate the problem if shorter runs are used instead of one continuous run.

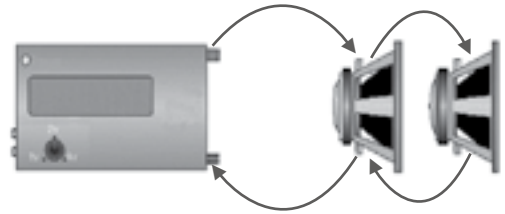

## Diagram 7: Proper Layout of Speaker Runs

This is the correct way to wire commercial speakers. If one speaker does not perform, the remaining speakers will still work and the problem will be easier to isolate.

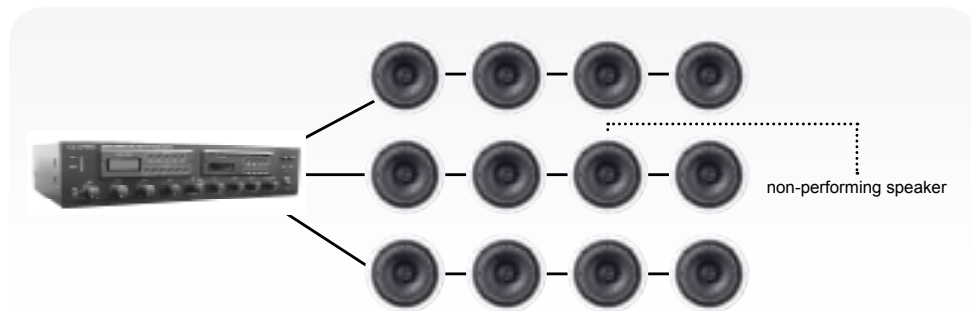

## What Wire Should I Use?

Generally, speaker wire is determined by the length of the run and the wattage utilized:

- Wire runs less than 50 feet and utilizing 50 Watts of power or less use 16 gauge wire.
- Wire runs more than 50 feet and/or over 50 Watts of power use 14 gauge wire.

When selecting your wire and line loss for length of speaker run, other specifications to consider are: UL Listing, Plenum Rating, weatherproofing, etc.

Speco Technologies has provided this information as an educational introduction to commercial sound systems. Speco Technologies assumes no liability for any information within this guide section and/or any action that is taken based on the information contained here. Please consult licensed professionals when performing commercial sound installations.

## Which Wattage Amplifier Do I Need?

Normally, to arrive at the necessary wattage requirement for an amplifier in a particular location, you will need to take the total sum of wattage you need, (considering all speakers, horns and their wattage tap settings) then add a 20 percent safety buffer. The worksheet to the right will aid in calculating this requirement.

## Determining Your Amplifier Needs for Sounds Systems

**Step 1:** Fill out Wattage Tap Requirement Chart (at right) to determine the number of speakers that will be used at each wattage tap for the amplifier.

**Step 2:** Multiply the number of speakers by each wattage tap to determine total wattage requirement per tap setting (See Ex. A).

**Step 3:** Add all the figures in the shaded area to determine the total wattage requirement for the amplifier.

**Step 4:** Match the total wattage requirement to the chart on the next page "Recommended Amplifier Wattage Chart" to determine acceptable RMS wattage the amplifier should have.

**Step 5:** Repeat this process for each amplifier system.

## Wattage Tap Requirement Chart

	Set Wattage Taps	X	Number of Speakers at Set Tap	=	Total Wattage Requirement per Tap
Example	5	x	10	=	50W
	60	x		=	
	30	x		=	
	20	x		=	
	15	x		=	
	10	x		=	
	7.7	x		=	
	5	x		=	
	4	x		=	
	3.75	x		=	
	2.5	x		=	
	2	x		=	
	1.50	x		=	
	1.25	x		=	
	1.00	x		=	
	0.50	x		=	
	0.25	x		=	
	0.125	x		=	

Total Sum of Shaded Area Represents Total Wattage Requirement

## Recommended Amplifier Wattage Chart

Sum Wattage Total	Acceptable Amplifier RMS Wattage			
	15 Watt	30 Watt	60 Watt	120 Watt
If Sum Wattage Total is 12 Watts or Less	X	X	X	X
If Sum Wattage Total is between 13 and 24 Watts	X*	X	X	X
If Sum Wattage Total is between 25 and 48 Watts	X*	X*	X	X
If Sum Wattage Total is between 49 and 96 Watts	X*	X*	X*	X
If Sum Wattage Total is between 97 and 204 Watts	X*	X*	X*	X*
If Sum Wattage Total is between 205 and 216 Watts		X*	X*	X*
If Sum Wattage Total is between 217 and 240 Watts			X*	X*
If Sum Wattage Total is between 241 and 288 Watts				X*

\* RMS Amplifier used in conjunction with Speco Technologies' P500A Power Booster Amp

# Audio Product Warranties



## AMPLIFIERS

These products are warranted against manufacturing defects in material and workmanship for **five (5) years** including parts and labor.



## INDOOR SPEAKERS

These products are warranted against manufacturing defects in material and workmanship for the **lifetime** of the product, including parts and labor.



## OUTDOOR SPEAKERS

These products are warranted against manufacturing defects in material and workmanship for **five (5) years** including parts and labor.



## P.A. HORNS, MICROPHONES & VOLUME CONTROLS

These products are warranted against manufacturing defects in material and workmanship for **two (2) years** from date of purchase including parts and labor.



## MEGAPHONES, SPEAKER DISTRIBUTION CENTERS & SPEAKER SELECTORS

These products are warranted against manufacturing defects in material and workmanship for one **(1) year** including parts and labor.



## OTHER AUDIO ITEMS NOT COVERED ABOVE:

These products are warranted against manufacturing defects in material and workmanship for ninety (90) days including parts and labor.

We warranty all products to be free from any manufacturing or material defects. This warranty will not extend to any products which have been subjected to misuse, neglect, accident, or improper installation, used in violation of instructions furnished by us; or to units which have been repaired or altered outside of the factory. This limited warranty does not apply to broken cases, batteries, or other physically damaged parts. Upon request by the customer, the company will at the customer's expense repack merchandise in new cartons, replace missing accessories, and return in resalable condition. Unless requested, the company will replace and return all merchandise in the packaging in which it was received. This warranty is in lieu of all expressed warranties, expressed or implied, and of all obligations or liability on our part, and we neither assume nor authorize any representative or other person to assume for us any obligation or liability. In no event shall we be liable for incidental or consequential damages arising from the use of the product, or for any delay in the use of this product do to causes beyond our control. Some states do not allow limitations of how long an implied warranty lasts and/or do not allow the exclusion or limitation of consequential damages. The above limitations on implied warranty and consequential damages may not apply to you.

This warranty gives you specific legal rights. You may have other rights which vary from state to state. See actual warranty statement included with product for limitations and exclusions where applicable. This limited warranty extends to products listed in the company's current price schedule.

## RETURNS

A written return authorization must be obtained prior to shipment. Label(s) must appear on all packages and return must be ship prepaid.

Defective in-warranty products will be returned prepaid. Defective out-of-warranty products will be repaired at a nominal charge for parts and labor and returned with shipping charges added to the invoice. If you require an estimate before repair, please request.

## RETURNED GOODS POLICY

1. RETURNS SENT WITHOUT PRIOR APPROVAL WILL NOT BE ACCEPTED. CREDIT WILL BE ISSUED UPON INSPECTION OF RETURNED UNITS.
2. No discounted item may be returned for credit or exchange.
3. An order of \$3.00 for every \$1.00 to be returned must accompany a request for return for stock adjustment.
4. There will be a minimum charge of 15% for handling and repacking where necessary. Merchandise returned for credit or exchange with missing or damaged packaging or accessories will be charged accordingly. Merchandise returned for repair will be shipped back repaired but in the same physical condition as when received by us. If repacking or refurbishing is requested, where possible, you will be charged accordingly.
5. If a credit is issued, current best quantity price or price when purchased, whichever is lower, will prevail.