

Frame Construction Ceiling Installation

1

Take the cutout template from the packaging box and punch out along the larger perforated circle. Place the cutout template against the bottom of the ceiling and trace the inside of it. Carefully cut out the ceiling material along the circle.

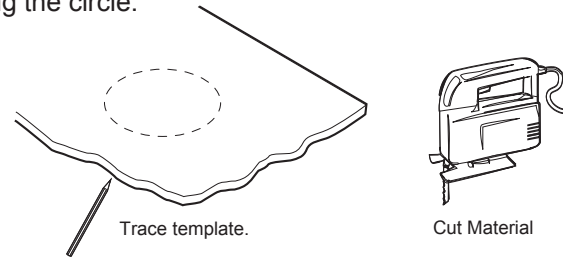

2

Remove the top cover to access the speaker connector. Attach the speaker wires to the 4-pole captive screw connector. Insert the 4-pole captive screw plug into the connector on back of the speaker. Install the conduit and secure the connections.

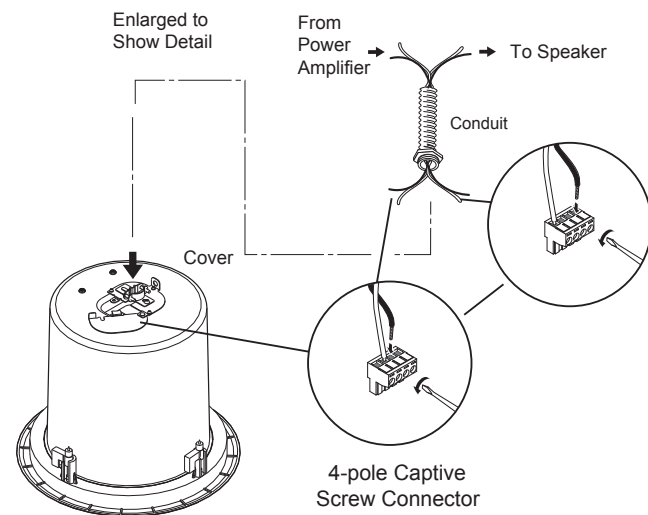

3

Replace the top cover and tighten the screws. Insert the speaker through the bottom of the hole in the ceiling.

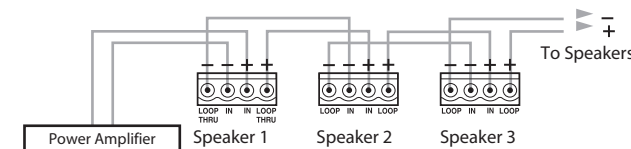

Parallel Hookup Wiring Diagram

4

Loosen the four screws on the front baffle(counter clockwise) 1/2 turn. Then tighten the screws (clockwise) until the dog legs clamp the speaker to the ceiling.

CAUTION Do not over tighten screws.

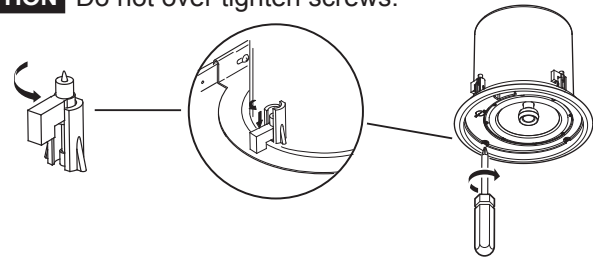

5

Connect a secondary support line from the seismic tab to a secure support point. Set the rotary tap selector and install the speaker grille.

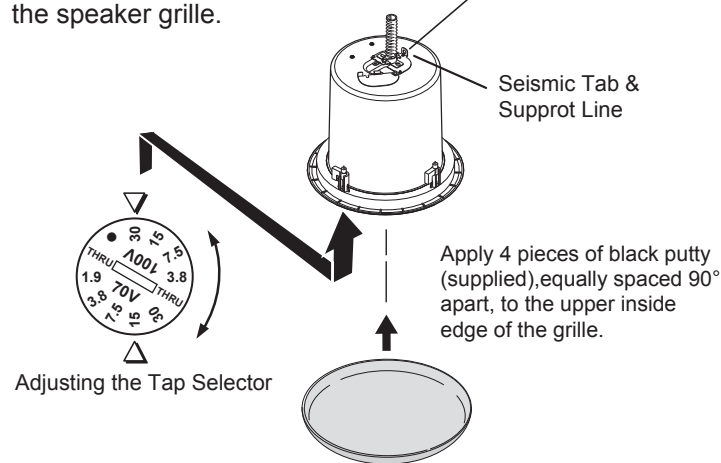

Specifications:

Acoustic & Electrical

Speaker type.....	2-way, ceiling speaker with metal back can
Frequency range.....	65 Hz to 20 kHz,
Power handling.....	60 Watts RMS 120 Watts PEAK
Nominal sensitivity.....	88 dB, 1W@1m
Nominal coverage angle.....	110° conical coverage
Nominal impedance	8 ohms
Transformer taps	70V: 30W, 15W, 7.5W, 3.8W, 1.9W, 8 ohms 100: null, 30W, 15W, 7.5W, 3.8W, 8 ohms
Woofers.....	6.5" (165 mm) polypropylene cone with moisture resistant coating
Tweeter.....	3/4" (19 mm) silk dome
Overload protection.....	Full range power limiter with the 8 ohm direct input only, protecting the tweeter, woofer, and crossover.

General

Temperature/humidity	Storage: -40 to +158 °F (-40 to +70 °C) / 10% to 90%, noncondensing Operating: +32 to +122 °F (0 to +50 °C) / 10% to 90%, noncondensing
Listings	UL1480
Compliances	CE
Warranty.....	1 years parts and labor

NOTE: All nominal level are at ±10%.
NOTE: Specifications are subject to change without notice.

Suspended Ceiling Installation

1

Remove the ceiling tile where the speaker is to be installed

2

Cut the hole in the tile. See step 1 of the **Frame Construction Ceiling Installation** section on the back.

3

Bring the speaker cable through the hole of the cut tile, then reinstall the tile.

4

Remove the adjacent tile. Place 2 V-rails and 1 C-ring across the tile where speaker is to be installed. Insert the speaker through the bottom of the hole in the ceiling tile.

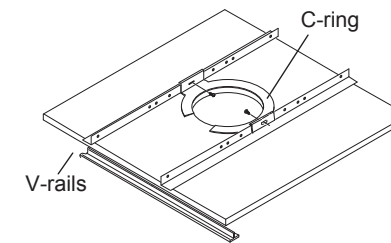

5

Connect the wires to the speak terminal clips (see step 2 on the back).

6

Loosen the four screws on the front baffle (counter clockwise) 1/2 turn. Then tighten the screws(clockwise) until the dog legs clamp the speaker to the ceiling.

CAUTION Do not over-tighten screws!

7

Connect a secondary support line from he seismic tab to a secure support point (see step 5 on the back).

8

Apply 4 pieces of black putty (supplied),equally spaced 90° apart, to the upper inside edge of the grille (see step 5 on the back).

Install the speaker grille.

Painting the Speaker Baffle

Cut along the smaller perforated line of the cutout template, marked as paint shield. Push it into the front baffle of the speaker. Paint the front. Remove the paint shield after the paint has dried.

Application diagram

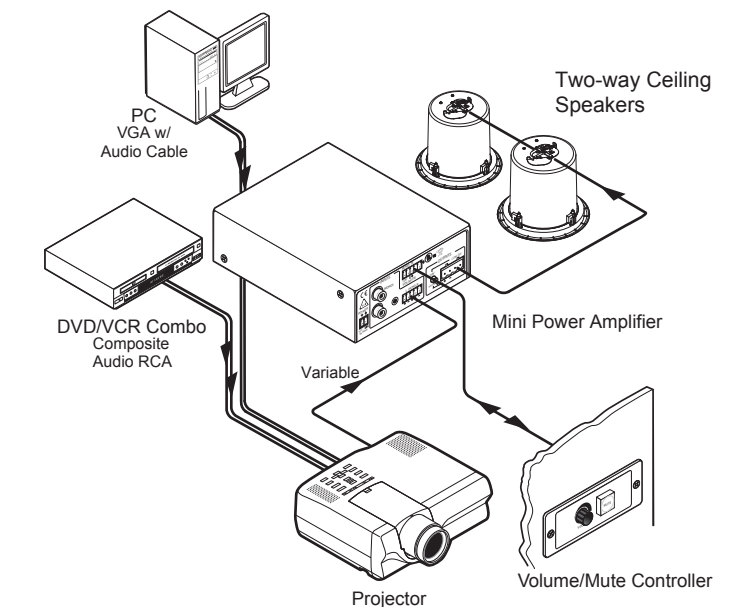

Packaging

