

STI SPEAKER GUARDS

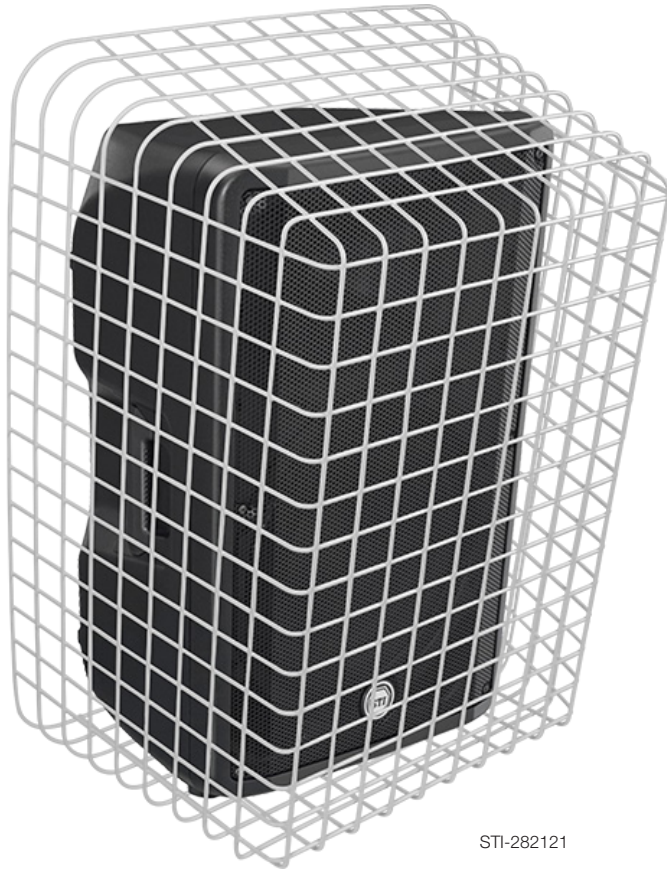

STI-282121

PRODUCT OVERVIEW

These members of the STI Wire Guard Team were created in response to multiple requests from STI customers. Constructed of 9-gauge steel wire coated with corrosion resistant polyester. The size and sturdy steel construction make the multi-use wire guards an easy choice for protecting speakers and a wide variety of sensitive equipment.

BACKED BY A THREE YEAR GUARANTEE

Constructed of tough steel wire that is coated with corrosion resistant polyester. It is not surprising STI backs them with a three year guarantee against breakage in normal use. These Stoppers are highly recommended for areas where abuse is severe or it is imperative that important devices continue to operate.

KEY FEATURES

General Information

- Guards protect speakers and a wide variety of devices against theft and vandalism.
- May be spray painted once prior to installation to match décor.
- Three year guarantee against breaking in normal use.

Construction

- Constructed of 9-gauge coated steel wire.
- Coated with corrosion resistant polyester.

Installation

- Fast and easy installation with all brackets, screws and anchors provided.

STI Speaker Guards

Dimensions and Technical Information

MODELS AVAILABLE

- STI-241416** Speaker Guard 24" x 14" x 16"
- STI-282121** Speaker Guard 28" x 21" x 21"

WARRANTY

Three year guarantee against breakage in normal use.

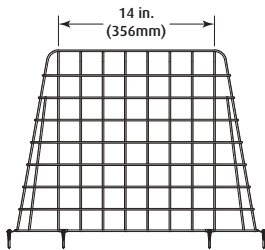
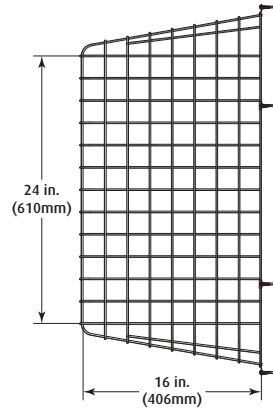
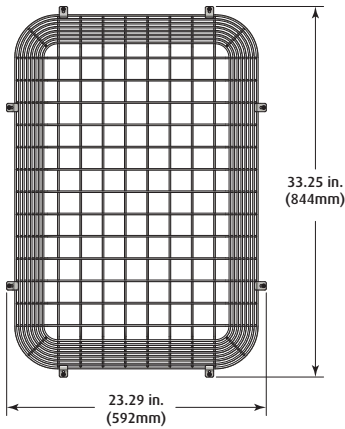

STI-241416

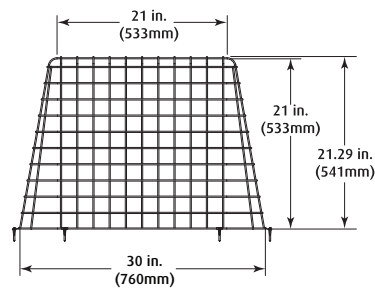
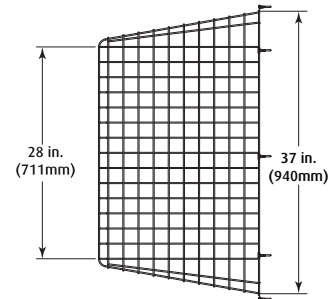
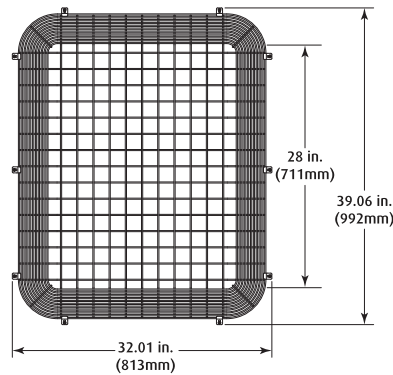

STI-282121



**Safety Technology
International**

2306 Airport Road
Waterford, Michigan
48327, USA

Tel: 248-673-9898
Fax: 248-673-1246
info@sti-usa.com
www.sti-usa.com

Taylor House
34 Sherwood Road
Bromsgrove, Worcestershire
B60 3DR, England

Tel: +44 (0)1527 520 999
Fax: +44 (0)1527 501 999
info@sti-emea.com
www.sti-emea.com