

TAKEX PASSIVE INFRARED SENSOR

PA-4810E (WIDE ANGLE) • PA-4820E (LONG RANGE)

Instruction Manual

We appreciate your purchase of a TAKEX passive infrared sensor. This sensor will provide long and dependable service when properly installed. Please read this Instruction Manual carefully for correct and effective use.

Please Note : This sensor is designed to detect intrusion and to initiate an alarm ; it is not a burglary-preventing device.

TAKEX is not responsible for damage, injury or losses caused by accident, theft, Acts of God (including inductive surge by lightning), abuse, misuse, abnormal usage, faulty installation or improper maintenance.

1 PARTS DESCRIPTION

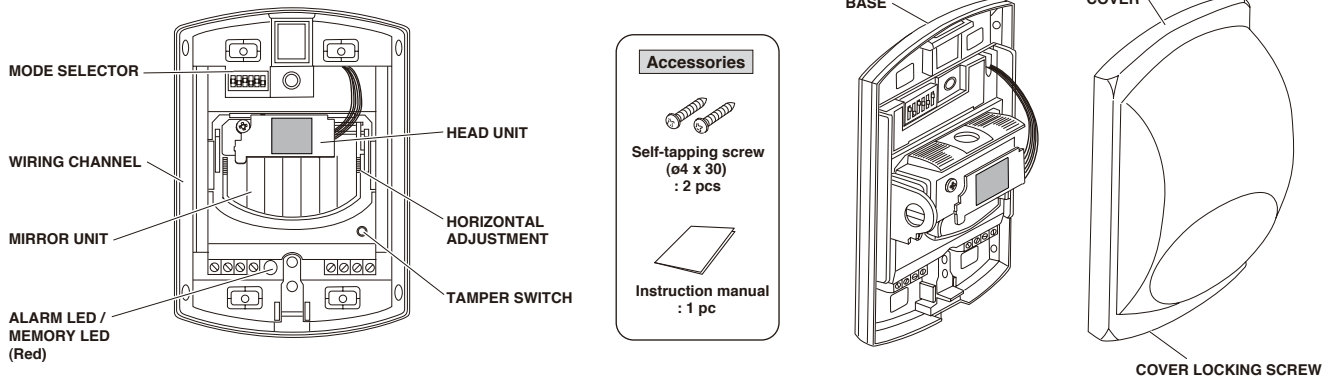

2 PRECAUTIONS Be sure to observe

• This manual describes precautions by classifying them based on degrees of danger and damage that would be generated if using the unit incorrectly.

Warning This indicates the possibility of severe injury, and even death, if ignored or a user handles the unit incorrectly.

Caution This indicates the possibility of minor injury and/or damage to properties, or of a notification delay in your system due to false operations and/or non-detection, if ignored or a user handles the unit incorrectly.

• We categorize these precautions throughout the manual using the following symbols.

⊘ A prohibited action, you must not do.

ⓘ An action you must do, and information you should keep in mind

Warning

⊘ Do not disassemble or modify this device. This may cause a fire, electrical shock, or malfunction of the device.

ⓘ If the following events occur, turn off the power of the unit immediately, and ask the place of purchase for repair. Failure to follow this may result in fire, electric shock, and/or malfunction.

- Smoke, abnormal odor, and/or sound are found
- Liquid, such as water, and/or foreign material has entered the unit
- The unit has deformed and/or damaged parts

ⓘ Mount the unit on a solid ceiling or wall surfaces where reinforcement materials are used. If you mount the unit on non-wood materials of plaster board or concrete, securely mount it using anchors and mounting screws that match the wall materials. Unstable mounting may result in injury and/or property damage if the unit falls.

⊘ Do not install this device in a location that cannot support its weight. This may cause the device to fall and cause an injury or malfunction of the device.

⊘ Do not use the unit with power voltage levels other than those specified. Failure to follow this may result in fire, electric shock, and/or malfunction.

ⓘ Use the sensor lock to fix the sensor unit for operation. This can prevent injuries, and/or damage to the unit if the unit falls, as well as prevent the sensor from being tampered.

⊘ Do not connect devices that exceed the indicated capacity to the output contact of the unit. Failure to follow this may result in electric shock, fire, and/or malfunction.

⊘ Do not touch terminals with wet hands. Failure to follow this may result in electric shock.

Caution

⊘ Do not apply impact to the unit. Strong impact may result in performance deterioration and/or damage to the unit.

ⓘ The unit may not operate properly near devices that generate a strong electric or magnetic field. Also, devices near the unit may not operate properly due to the magnetic field and/or magnetism generated from the unit. Make sure to confirm before operation.

ⓘ Make sure to perform a sufficient operation check on the whole system before operation.

ⓘ Avoid installing the unit in the following places. Otherwise, non-detection and/or false detection may occur.

- Places subject to strong direct or reflected light (sunlight, spotlight)
- Places subject to rapid temperature fluctuations (air outlets of air-conditioning equipment, etc.)
- Places where moving objects are included in the protection area (plants, laundry, etc.)
- Places subject to strong vibration and/or electric noise
- Places where pets, such as dogs and cats, and/or automatic cleaning robots may pass
- Places where shielding objects (including glass and transparent resin, etc.) are included in the protection area (shading parts will not be detected)
- Places that people can easily touch.

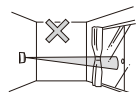

Facing the window

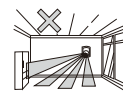

Refrigerator



Plants/Curtain

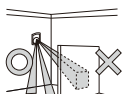

Shielding objects

ⓘ Refer to the protection area figures, and select the installation location. Then, check the actual operation, and adjust the appropriate area.

ⓘ Make sure to check operation when you move tables and partitions and change the layout in protected rooms.

ⓘ Passive infrared sensors are designed to catch changes of far-infrared ray energy. Energy changes largely when the human body moves across the protection area, which is easy to detect. However, energy does not change greatly when the human body comes closer in a straight line, or stops, which may be difficult to detect. In addition, if the protection area environment generates similar changes due to certain factors, the unit will set off an alarm without being able to judge properly.



⊘ Do not install the unit in places subject to oil smoke or steam, high humidity, and/or a lot of dust. Electricity that travels through these substances may result in fire, electric shock, and/or false operation.

ⓘ Ask qualified personnel for any electrical work necessary for installation, if required. Failure to follow this may result in fire and/or electric shock.

ⓘ Securely conduct installation work according to the instruction manual. Also, make sure to use the supplied accessories and specified components. Failure to follow this may result in injury and/or property damage in the event of fire, electric shock or fall of the unit.

ⓘ This unit is for indoor use. Do not use the unit in places subject to water and/or high humidity. Failure to follow this may result in malfunction if water gets into the unit.

ⓘ This unit is not a waterproof (moisture proof/rainproof) or dust-proof structure. Do not use the unit in places subject to water and/or high humidity, such as bathrooms, and/or subject to large amounts of dust or sand. Failure to follow this could result in malfunction.

⊘ Do not perform aerial wiring of power and signal cables. Failure to follow this may result in electric shock, fire, and/or malfunction.

⊘ Do not install the sensor directly on the ceiling (When installed on ceiling, use optional attachment BCW-401)



3 COVERAGE

WIDE ANGLE (PA-4810E)

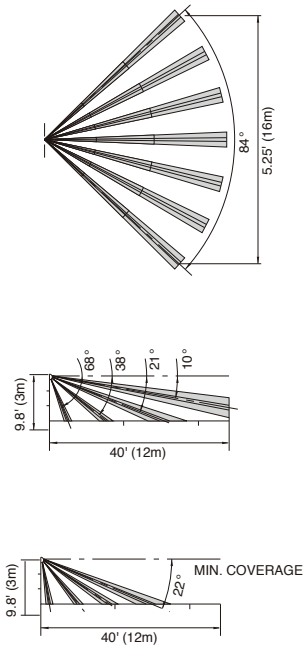

LONG RANGE (PA-4820E)

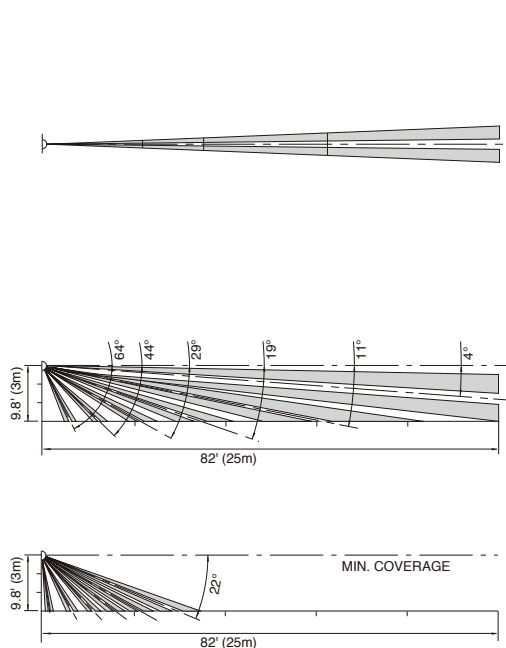

4 INSTALLATION

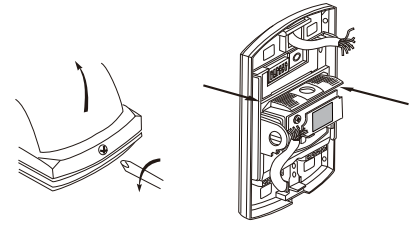

(1) Detach the cover. Loosen screw until cover slips.

CAUTION : Do not remove screw from cover. This will prevent locking nut from falling out and becoming lost.

(2) Connect wires.

*Break the knockout and pull in the wire through it. When using the upper wiring knockouts, route wires along wiring channel on either side (→ portion) of plastic frame of P.C. Board.

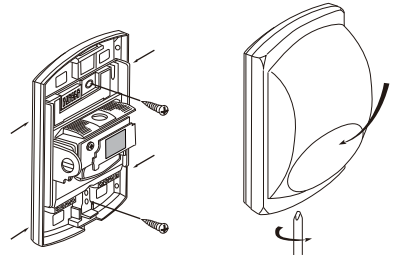

(3) Install the base on the wall. Knockout appropriate wiring and mounting screw holes. Feed wire through knockout.

*Two mounting pitches are available for mounting to a single gang box.

*When installed on wall corner, make use of 4 mounting knockouts on sides.

(4) Attach the cover, and check operation.

5 WIRING

(TERMINAL ARRANGEMENT)



- | | |
|---|--|
| 1 2 POWER (non-polarity)
9.5V to 28V DC | } 25mA Max. |
| 3 4 ALARM OUTPUT
Dry contact (semi-conductor) | |
| 5 VACANT | } LED Control |
| 6 L/C | |
| 7 8 TAMPER OUTPUT
Dry contact | } N.C. contact
Operation : Open when cover is detached.
30V DC 0.1A Max. |
| | |

(BASIC CONNECTION)

[When two units are used]

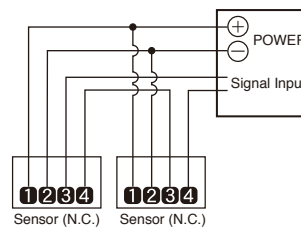

(ALLOWABLE WIRING DISTANCE BETWEEN SENSOR AND POWER SOURCE)

Size of wire used	Distance at 12VDC	Distance at 24VDC
AWG 22 (Dia.0.65mm)	3800ft (1160m)	2200ft (6700m)
AWG 18 (Dia.1.0mm)	5900ft (1800m)	3400ft (10400m)
AWG 16 (Dia.1.25mm)	9300ft (2840m)	5500ft (16500m)

Note : 1) Maximum wiring distance, when two or more sets are connected, is the value above divided by numbers of sets.

2) The signal line can be wired to a distance of 3,280 ft (1,000m) with AWG 22 (0.65mm dia.) wire.

* Allow approx. one minute for warm-up after power is applied. (Alarm LED is flashing) In the meantime, no alarm is initiated.

* After the one minute has passed the unit will be in the armed condition and will trigger when detecting a human body.

6 AREA SETTING

Adjust/check detection area visually in the following procedure when operation check shows improper area adjustment.

ADJUSTMENT OF THE FIELD VIEW

When operation check shows improper area setting, check visually its area setting.

- Slide the head unit to bring the sensor unit into aiming position. Slip to the arrow direction and it will be automatically locked at testing position.
- Adjust the coverage by moving the mirror so that LED on the head unit is visible through mirror from location to be protected.

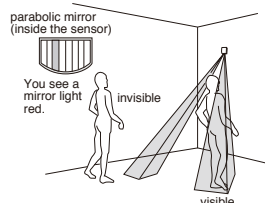
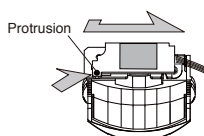

ADJUST UNDER AIMING POSITION

VERTICAL ADJUSTMENT

- Adjust with parabolic mirror rotating by hands. Do not touch the mirror surface.

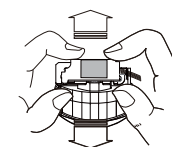

HORIZONTAL ADJUSTMENT

- Hold parabolic mirror by hands and push for horizontal adjustment.

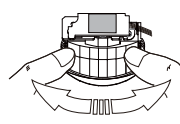

- After adjustment is completed, lightly push head unit. It will replace to the armed position automatically.

* When head unit is placed at testing position, alarm LED lights and alarm output continuously outputs (Trouble alarm).

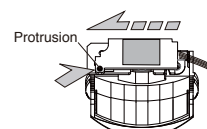

7 SENSOR FUNCTIONS

Sensor operation can be adjusted to fit the environments / applications with the built-in mode selector.

ALARM LED

The alarm LED will light up, synchronized with the alarm contact, if you set the mode selector at ON.

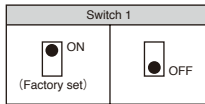

LED CONTROL

LED CONTROL FUNCTIONS

Wire terminal 6 (L/C) through an external control contact switch with Power (-).

OPERATION

Turn the Mode selector 1 OFF.
When the switch is turned ON, the alarm LED lights at alarm.
When the switch is turned OFF, the alarm LED does not light.

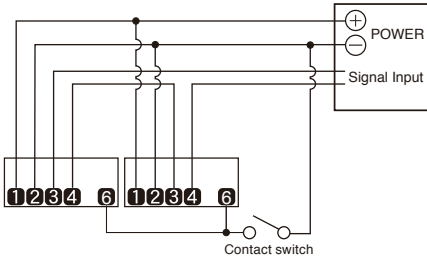

ALARM MEMORY

Memory LED will inform you which sensor initiated an alarm during alert conditions when two or more sensors are connected on the same line.

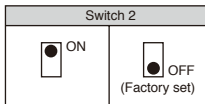

When this setting is "ON". Memory is always stored when sensor is armed. When an alarm has been activated, the memory LED flashes for 3 min. and then remains lit for 47 min. It automatically reset and memory is also canceled.

NOTE : Same LED is used to indicate both alarm and alarm memory.

ALARM CONTACT CHENGEOVER

Change alarm contact to N.O. when sensor is used for an application except security purpose, such as light control.

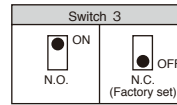

SETTING OF SENSITIVITY

When operation check shows you high sensitivity of sensor, change setting of sensitivity with mode selector and re-check operation.
Four settings are available.

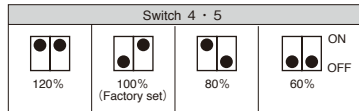

FINE MOTION DETECTION

Make use of the fine motion detection (motion of hands or body) at narrow range.

NOTE : This mode is so sensible to detect even a slight motion that the performance to discriminate small animals might be low.

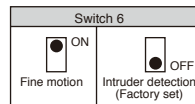

FACTORY SET

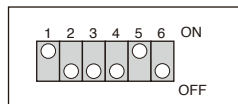

Built-in CPU automatically checks/monitors sensor unit function, regardless of mode settings except a part of features.

TROUBLE ALARM

This function checks / monitors sensor unit itself in accordance with built-in program.
When trouble is found out as a result of the check / monitor, alarm LED lights and an alarm signal also continuously outputs.

1 : Unit trouble

Trouble alarm outputs when inner circuit / wiring is damaged / broken.
See 9, troubleshooting and remedy table.

NOTE : The monitor functions regardless of mode settings but an alarm is not indicated in case of setting alarm LED at OFF position.
When power is reset during the alarm status, trouble alarm stops only for warming up time.

2 : Low voltage

When power voltage of sensor drops down (approx. 8.5V DC or less), trouble alarm outputs before sensor operation comes to be unstable due to low voltage.
See troubleshooting and remedy table.

NOTE : The monitor functions regardless of mode settings but an alarm is not indicated in case of setting alarm LED at OFF position.
When power voltage recovers to normal level during the alarm status, trouble alarm stops.

3 : Failure to replace

Trouble alarm outputs to prevent failing to replace sensor head unit which is set for aiming. Alarm stops when the sensor head unit is replaced to alert position.

NOTE : The monitor functions regardless of mode settings, but an alarm is not indicated when alarm LED is set to OFF position.

8 OPERATION CHECK

When installation is completed, turn the power "ON" and check operation, after about 1min. warming up time, as follows:

1. Make sure that alarm LED finishes flickering.
2. Walk test in the protected area to check if an alarm is initiated. Check alarm LED and control panel for sensor operation.
3. After correct operation has been confirmed, use the mode selector switch to disable the alarm LED, if required.

9 TROUBLESHOOTING

Analyze possible problems according to the following table. If normal operations cannot be restored by this means, contact either the dealer from whom you bought the unit or TAKEX.

Trouble	Possible cause	Corrective action
Completely inactive.	●Either power is OFF (including broken cable) or power voltage is too low.	●Check the power cable and adjust power voltage properly.
	●Not yet 1 min. after power turned on. (Is alarm LED flickering ?)	●Allow for warm-up time.
	●There is an obstacle in front of the detection area.	●Remove the object.
	●Improper detection area adjustment.	●Readjust the detection area setting.
Sometimes inactive.	●Improper detection area adjustment .	●Readjust the detection area setting.
	●Cover surface soiled.	●Clean cover with a soft cloth. (Do not use thinner, etc.)
	●The detection range exceeds. 40ft. (12m) (Wide angle) 82ft. (25m) (Long range)	●Reposition so that the range is less than 40ft. (12m) (Wide angle) or 82ft. (25m) (Long range)
Activated when no person has passed.	●Improper power supply.	●Correct power supply.
	●Something moving in protected area or too rapid temperature variations.	●Remove the cause.
	●A source of electrical noise (broadcasting station, amateur radio etc.) nearby.	●Change the installation location.
	●Strong sunlight reflection or direct light hitting the unit.	●Change the installation location. ●Shield sunrays with a blind.
Alarm LED lights, though connected units are inactive.	●The detector reacts to passersby outside.	●Readjust the detection area.
	●Poor contact output connection or broken wire.	●Check the wiring.
	●Connected units are damaged.	●Check connected units.
	●Damaged alarm contact.	●Check alarm output terminals with tester.
Alarm LED continues to light and alarm continues to be initiated. (Trouble alarm)	●Head unit fails to be replaced.	●Replace to armed position.
	●Too low power voltage.	●Adjust power voltage properly.
	●Trouble alarm initiated again after warming-up period, though power is reset.	●There is a possibility of inner broken wire/damage.

MAINTENANCE

- To clean the device, use a soft, wet cloth and then wipe off any water drops.
- If the device is particularly dirty, dip the soft cloth in the water that contains a weak neutral detergent. Wipe the device gently with the cloth, then wipe off any detergent that remains. Do not use substances such as thinner or benzene. (The plastic parts may deform, discolor or change their properties.)
- Perform operation checks on a regular basis.

10 SPECIFICATIONS

Passive infrared sensor	
Model	PA-4810E PA-4820E
Detection system	Passive infrared (QUAD)
Coverage	Wide angle protection 40' (12m) Max. Long range protection 82' (25m) Max.
Sensitive zone	72 (18 pairs) 24 (6 pairs)
Supply voltage	9.5 to 28V DC (non-polarity)
Current consumption	25mA Max. (N.C./N.O. contact)
Alarm output	Dry contact (Semi-Conductor) Reset : Approx. 2 sec. (N.C./N.O. selectable) 30V DC (24V AC) 0.25A Max. (protective resistor 3.3Ω)
Tamper output	Dry contact (type N.C.) Open when cover is detached 30V DC 0.1A Max.
Alarm memory	3min. -Flickering, 47min. -Lighting
Fine motion detection	Sensitive zone : 36 pairs Sensitive zone : 12 pairs
LED (Red)	Alarm LED Flickering (every 0.5 sec.) : Warming-up Lighting (approx.2sec.) : Alarm Flickering (every 0.25 sec.) : Trouble indication Continuous lighting : Trouble alarm (Disabled is LED except trouble indication) Memory LED Flickering : Memory activated Lighting : Memory indicated
Trouble signal	Unit trouble : Monitoring inner circuit and wiring damage ●Operation : Trouble alarm Low voltage trouble : Monitoring low voltage ●Operation : Trouble alarm Positioning trouble : Monitoring failure to replace view finder ●Operation : Trouble alarm
Ambient temperature range	+14°F to +122°F (without dewdrops) (-10°C to +50°C)
Mounting position	Indoor (wall / pillar)
Wiring connections	Terminals
Weight	5.82oz (165g)
Appearance	resin (White)
Adjustment range	Vertically 20° Horizontally ±5°

The specifications are subject to change without notice.

11 EXTERNAL DIMENSIONS

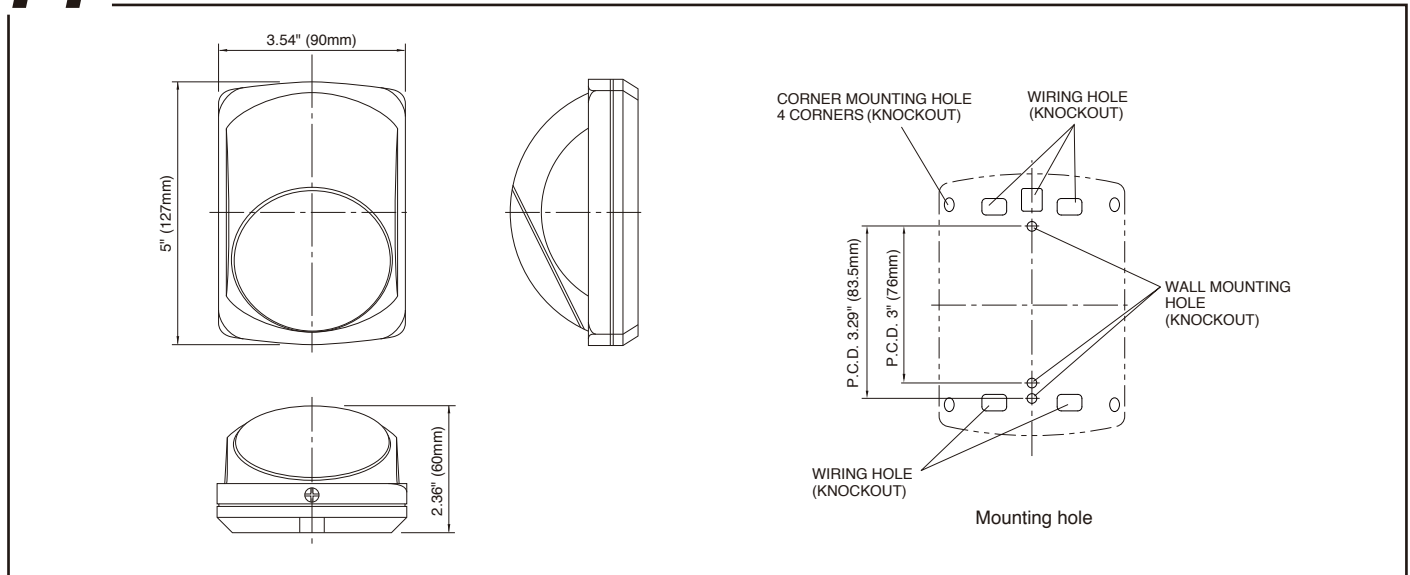

Limited Warranty :

TAKEX products are warranted to be free from defects in material and workmanship for 12 months from original date of shipment. Our warranty does not cover damage or failure caused by natural disasters, abuse, misuse, abnormal usage, faulty installation, improper maintenance or any repairs other than those provided by TAKEX. All implied warranties with respect to TAKEX, including implied warranties for merchantability and implied warranties for fitness, are limited in duration to 12 months from original date of shipment. During the Warranty Period, TAKEX will repair or replace, at its sole option, free of charge, any defective parts returned prepaid. Please provide the model number of the products, original date of shipment and nature of difficulty being experienced. There will be charges rendered for product repairs made after our Warranty Period has expired.



In Japan
Takenaka Engineering Co., Ltd.
 83-1, Gojo-sotokan,
 Higashino, Yamashina-ku,
 Kyoto 607-8156, Japan
 Tel : 81-75-501-6651
 Fax : 81-75-593-3816
<http://www.takex-eng.co.jp/>

In the U.S.
Takex America Inc.
 151 San Zeno Way
 Sunnyvale,
 CA 94086, U.S.A
 Tel : 408-747-0100
 Fax : 408-734-1100
<http://www.takex.com>

In Australia
Takex America Inc.
 4/15 Howleys Road, Notting Hill,
 VIC, 3168
 Tel : +61 (03) 9544-2477
 Fax : +61 (03) 9543-2342

In the U.K.
Takex Europe Ltd.
 Aviary Court, Wade Road,
 Basingstoke, Hampshire. RG24 8PE, U.K.
 Tel : (+44) 01256-475555
 Fax : (+44) 01256-466268
<http://www.takex.com>