

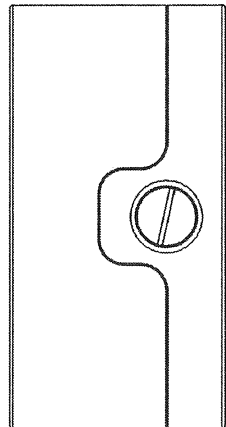

VSA-2 System

VAULT SOUND ALARM SYSTEM

INSTALLATIONS MANUAL and USER'S GUIDE

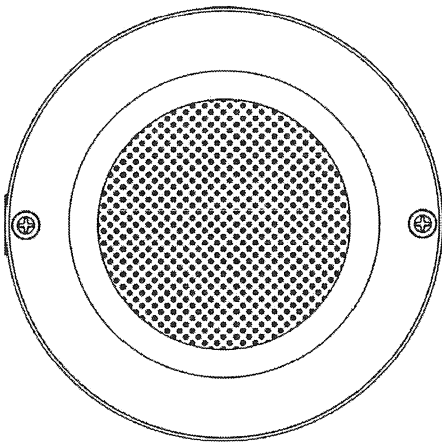

Potter Electric Signal Company
2081 Craig Road, St. Louis, Mo 63146
Phone (800) 325-3936, Fax (314) 878-7264
<http://www.pottersignal.com>

#5403551 Rev. B

General Information

Thank you for purchasing POTTER VSA VAULT SOUND ALARM SYSTEM. Please read this manual thoroughly before making connections and operating the unit. The instructions in this manual will enable you to obtain optimum performance from the system. Please retain this manual for future reference.

The Vault Sound Alarm (VSA) is a sound detection system conforming to the requirements of Underwriters' Laboratories, Inc. for the primary protection of reverberant and non-reverberant vaults such as bank and mercantile vaults. The VSA system must be used with an appropriate UL listed control unit where UL certification is required.

The VSA contains a microprocessor driven DC differential balance control which is adjusted so that the impedance of the microphone circuits are balanced with the internal impedance of the differential circuit. The VSA will alarm through its SPDT alarm relay contacts if the microphone circuit impedance changes over a certain threshold.

The standard VSA-2K package consists of one VSA-1 Control Unit / Microphone, one VSM microphone, and one Remote Test Annunciator (RTA) for the installations in vaults up to 24' x 12' size. Up to 9 additional VSM microphones can be installed per one VSA-1 Control Unit / Microphone for the installations in larger vaults. For vaults smaller than 12' x 12' the VSA Control Unit / Microphone may be used as a stand-alone unit. The installations can be either surface mount or flush mount using optional VFM flush mounting kit. The VSA requires the Remote Test Switch (RTA) for the applications requiring an alarm indicator and test switch outside the vault.

Features

- **Sound Detection System** satisfying requirements of Underwriters' Laboratories, Inc. for the primary protection of reverberant and non-reverberant Vaults
- **Coverage expandable** by adding up to nine (9) additional microphone units (VSM): total ten (10) microphones including one VSA-1 Control Unit
- **Automatic self sensitivity test** feature to provide early detection of system failure
- **Built-in Test Sounding Device (VSA-1)**
- **Manually adjustable sensitivity** to detect all attacks set forth in UL 639 and UL 681 for sound detectors.
- **Built-in Accumulating Pulse Counter** permitting 0-9 accumulated signals before alarm is signaled to prevent false alarm.
- **Enclosure:** High Impact PC/ABS alloy based enclosures with tamper
- **Input Power:** 9.0 VDC to 16.0 VDC, 12 VDC Nominal
- **Outputs:** 1 Form C for alarm relay, 2.0 Amps @ 30 VDC
1 Form B for tamper relay, 2.0 Amps @ 30 VDC
- **Connections:** Wiring connections through two 1/2" conduit openings
- **Components:** VSA-2K: One VSA-1, One VSM, and One RTA packaged as a system
VSA-1K: Control Unit / Amplifier and Microphone w/ RTA
VSA-1: Control Unit / Amplifier and Microphone
VSM: Additional Microphone for VSA-2 System
- **Accessories:** RTA: Potter remote annunciator
VFM: VSA flush mounting adapter
- **Retrofit:** may be used inconjunction with existing Potter PSM microphone

Complete Kit Parts List

VSA-2K Package includes: One VSA-1 Control Unit / Microphone, One VSM additional Microphone, One Remote Test Annunciator, Four mounting screws, Manual

VSA-1K Single Package includes: One VSA-1 Control Unit / Microphone, One Remote Test Annunciator, Two Mounting Screws, Manual

System Controls and Names

Refer to System Installation and Setup for detailed use.

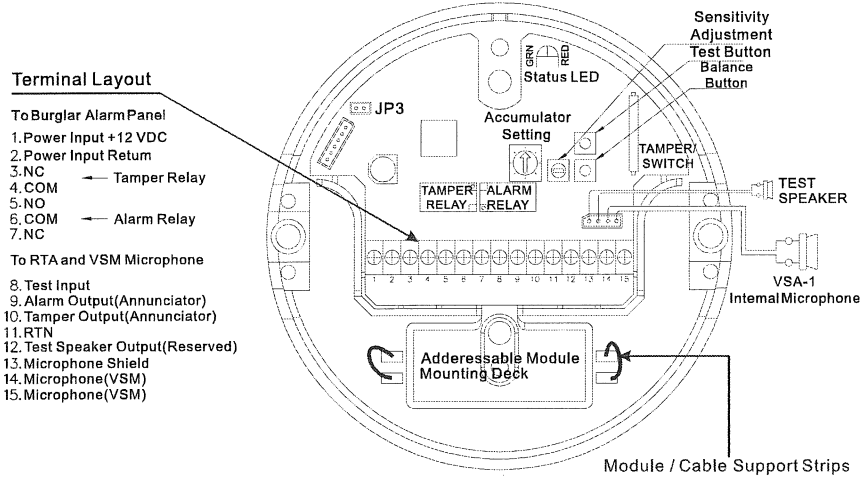

Item	Description
Status LED	Bi-color LED status indicator (refer to Table 1)
Balance Button	On-board button for balancing the installation
Test Button	On-board test button for testing installation
Jumper (JP3)	Self Sensitivity Testing feature enable / disable Jumper Jumper ON: Self-testing Enable Jumper OFF: Self-testing Disable. *This feature is not evaluated by UL.
Relay Contacts	Alarm relay: Form C COM: common signal connection NC: normally closed to COM with normal conditions and control operation NO: normally open to COM with normal conditions and control operation Tamper relay: Form B COM: common signal connection NC: normally closed to COM with normal conditions and control operation.
Accumulator Setting	Switch for enabling and setting the number of accumulated alarm events before VSA-2 signals and alarm condition. (0~9)
Sensitivity Adjustment	Adjustment potentiometer for setting the sensitivity of the VSA-2 system. (Clockwise more sensitive)
Addressable Module Mounting Deck	A deck to place an ID Addressable module if intended. The black support strips can be used to hold the addressable module or cables in place "Addressable module not to be used with this U.L. Listed Product"

[Table 1] VSA-2 Operation States: Status LED

Mode	Color/State	Meaning	Alarm Contact	Tamper Contact
Steady	Green	Normal	COM-NC	Closed
Blinking	Green/Red	System Auto-Balancing, Alarm and Tamper Conditions	COM-NO	Open
Blinking	Green	System Balanced, Tamper Condition	COM-NC	Open
Steady	Red	Alarm Condition	COM-NO	Closed
Steady	Amber	Tamper Condition	COM-NC	Open
Blinking	Red	Self Sensitivity Testing Failure	COM-NC	Open
Blinking	Red/Amber	Alarm and Tamper Conditions Simultaneously	COM-NO	Open
Steady	Off	No power to VSA-2	COM-NO	Open

[Table 2] RTA LED Status Table

Mode	Color/State	Meaning	Alarm Contact	Tamper Contact	RTA: Alarm Red LED	RTA: Tamper Yellow LED
Steady	Red	Alarm Condition	COM-NO	Closed	On	Off
Steady	Amber	Tamper Condition	COM-NC	Open	Off	On
Steady	Red/Amber	Alarm and Tamper Conditions	COM-NC	Open	On	On
Steady	Off	No power to VSA-2	COM-NO	Open	Off	Off
Steady	Off	System Normal	COM-NC	Closed	Off	Off

Important Notes before the Installations

- Always use approved UL components together
- Sensitivity of the VSA must be set:
 - after the unit is completed mounted on the intended locations
 - with enclosure covers closed
 - under the conditions as close as the normal operating environments of the vaults
 Proper sensitivity cannot be acquired if the enclosure covers are opened.
- It is not recommended to use the VSA in a fur vault: Absorption of sounds by furs may decrease sensitivity of VSA depending on the volume of furs in the vault.
- Recommended coverage of one VSA Microphones (VSA-1, VSM)
 - It is recommended to install at least one VSA-1 or VSM in every 12' X 12' area. Refer to the typical microphone layout below. Exact layout may need to be adjusted based on the physical conditions of the individual vault.
- Each detector must be tested at least once per year.
- The maximum wire run between the VSA-1 and the farthest VSM is 250 feet.
- All the wiring between the VSA-1 and VSM must be in 1/2" conduit.

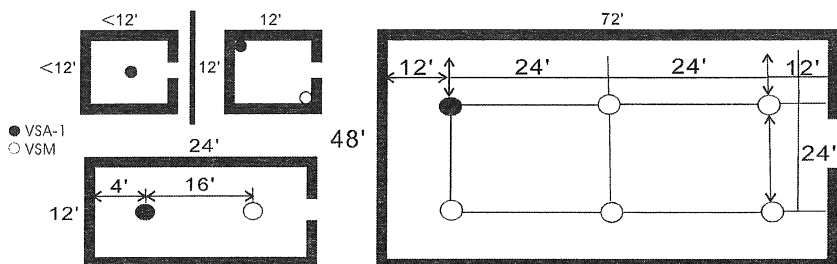

System Installations and Setup

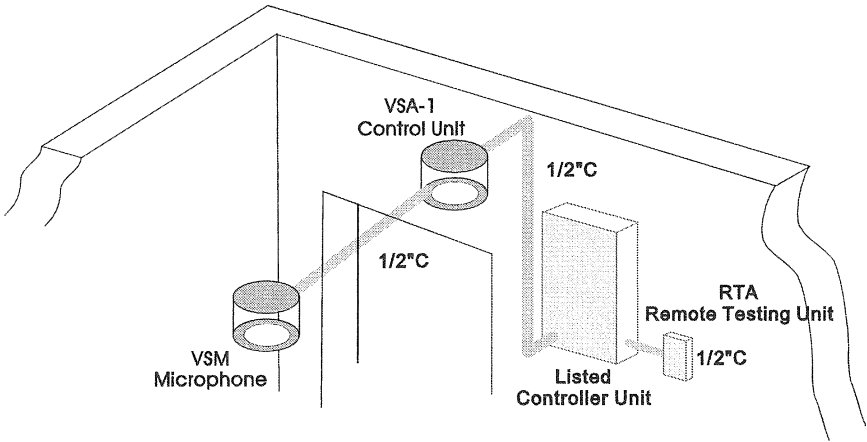

**The RTA does not connect to the alarm control panel.
The RTA is connected directly to the VSA-1. The RTA uses
the control panel as a junction box in this example.*

Installation Example

1. Installations of VSA-1 Control Unit and VSM Microphone

- 1) Open the enclosure cover and conduit hole cap (Fig. 1).
- 2) Mount the base on the intended location. Connect the conduit pipes and draw the wires through the conduit pipes (Fig. 2).
- 3) Install the additional VSM Microphones as 1)~2) above if necessary.
- 4) Make the wiring connections according to the wiring diagram (Fig. 5). All the wiring between the VSA-1 and VSM must be in 1/2" conduit.
Make sure to remove the jumper wire (Terminal 14 and 15) in case of using VSM microphones. Arrange the wires per (Fig. 3), using 18AWG-22AWG shielded wire. (Belden 8761 or similar alternate is recommended.)
- 5) Perform the setups as described in "2. System Setup" herein below, and close the cover (Fig. 4).

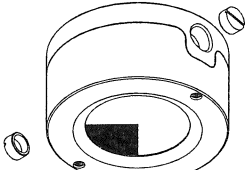

Fig1

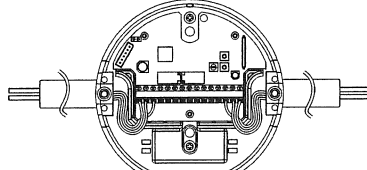

Fig3

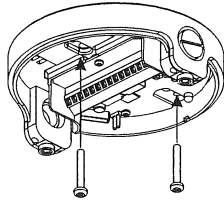

Fig2

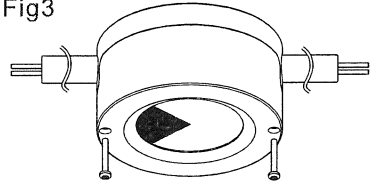

Fig4

Installation of the VSA-1 Control Unit and PSM Microphones

**The VSA-1 is U.L> listed with the PSM series microphones (PSM, PSM-F) for retrofitting an original VSA system.*

- 1) Open the enclosure cover and conduit hole cap (Fig. 1)
- 2) Mount the base on the intended location. Connect the conduit pipes and draw the wires through the conduit pipes. (Fig. 2)
- 3) Install the additional PSM Microphones as 1)~2) above, if necessary.
- 4) Make the wiring connections according to the wiring diagram (Fig. 6). All the wiring between the VSA-1 and the PSM's must be in 1/2" conduit.
Use only 18AWG-22AWG shielded wire.(Belden 8761 or similar alternate is recommended.)
- 5) Perform the setup as described in "2. System Setup" and close the cover.(Fig. 4)

Fig. 5 Wiring Diagram

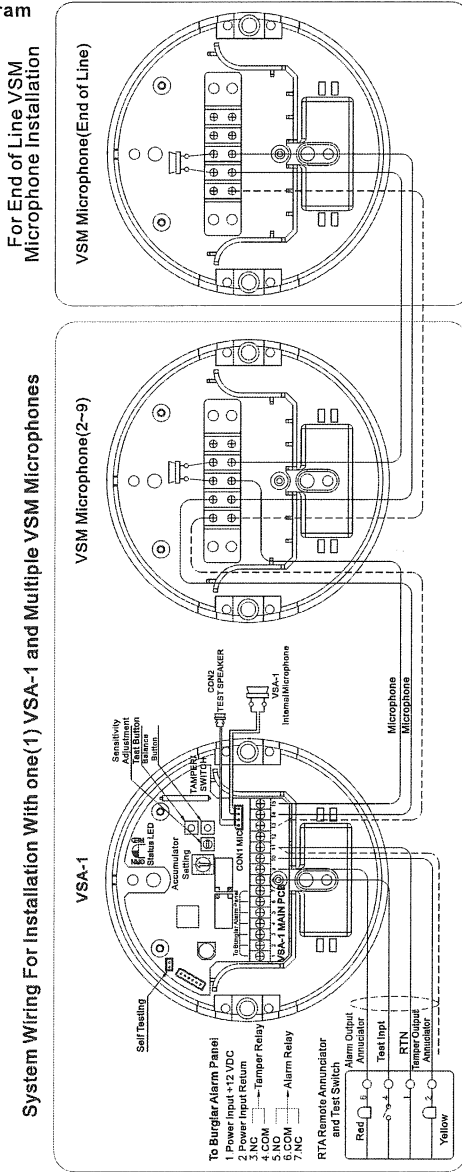

WARNING - Incorrect connections may result in damage to the unit

Fig. 6 Wiring Diagram(When installation with legacy PSM microphones)

For End of Line PSM
Microphone Installation

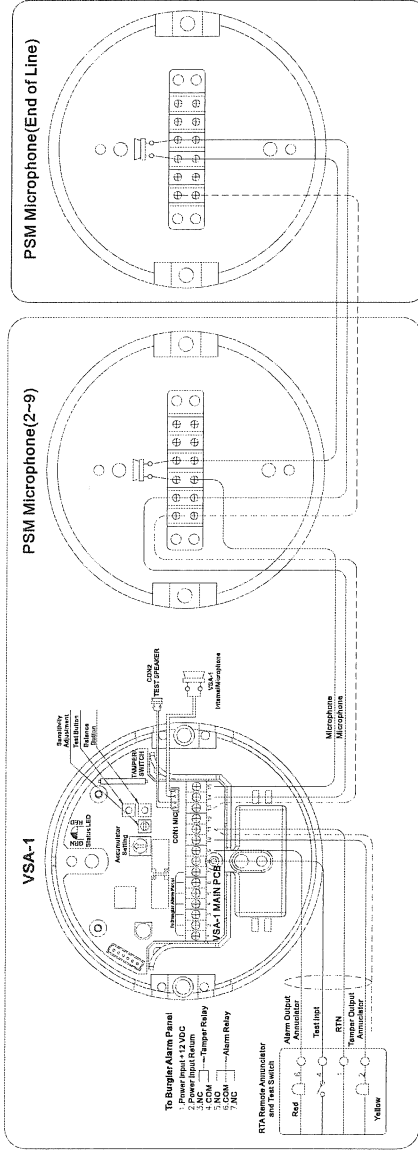

2. System Setup

Balancing

After installation and when the system is in a non-alarm condition, press the balance button once to initiate the self-balancing process and to adjust the system's impedance in accordance with the installation environment. *When pressing SW1, the balancing process is initiated with a single beep and status LED will alternately blink RED/GREEN. The balancing process is completed by the microprocessor within 4 seconds acknowledged by a double beep tone and a GREEN on status LED.* LED will blink green if the VSA-1 is in a tamper condition. A magnet can be placed near the top of the tamper to place the system in normal condition.

Sensitivity Adjustment

Adjust the sensitivity level using Sensitivity Adjustment VR1. The RED LED will not indicate when the sensitivity pod is set at 1/3 or below.

Strike the vault surface with a plastic mallet and adjust the sensitivity control to provide desired protection. (rotate clockwise for more sensitivity). **When testing, make sure the enclosure cover is closed and the microphone grill is not blocked for precise adjustment.**

Caution: Extreme care should be exercised so that the protected surfaces are not marred or damaged while performing the attack tests.

Testing

Pressing the test button on front of the VSA-1 applies a test signal to the built-in sounding device causing the VSA to go into an alarm condition, which is indicated by a RED LED adjacent to the test button. (The RED LED will not indicate when sensitivity pod is set at 1/3 or below).

If system will not test properly, increase sensitivity control setting until reliable manual tests are obtained. Verify that reliable tests are obtained at RTA remote test unit too.

When performing the annual system test, use the internal test button on the VSA-1

The tamper may be tested by removing the cover and observing the LED status.(see table 1)

Accumulator Setup

The integrated pulse accumulator accumulates up to nine (9) alarm conditions and will only alarm after the specified number of alarms takes place within a ten (10) minute span. Setting the accumulator to zero disables accumulation feature.

IF A SINGLE PULSE EXCEEDS THE ALARM THRESHOLD THE UNIT WILL ALARM.

Self Sensitivity Testing Setup(This feature not evaluated by U.L)

VSA-2 is designed to validate the system's performance by automatically testing the system's performance, daily, using its built-in test sounding device. This feature enables the user to be informed of possible system degradation due to severe environmental changes in the vault.

- Disconnect the power once, and **connect the power again while simultaneously pressing the test switch SW2 or the RTA test button.** Hold the test button until the generated tone silences. The system will save the current response characteristics into the system's memory by collecting electrical information against a self-generated testing sound for several seconds.

- Setup is done. The system will execute the auto-test every 24 hours. If the test fails the system will re-execute the test up to four times again with the interval of 30 minutes to validate actual system degradation. Upon failure of five consecutive tests (including the first failure) the system will a. Trigger the tamper failure signal to the control panel, and b. the status LED will blink red.

- Note: You can Enable / Disable the feature using JP3 (On=Enable / Off=Disable).

3. Installations of VSA with VFM flush mounting kit

For flush mounting the VSA-1 or the VSM, an optional VFM flush mounting kit is required.

- (1) For flush mounting of VSA users need to provide gang holes of 6.6" x 6.6" with 2.9" depth.
- (2) Using the screws provided, mount VSA bottom cover and VFM bracket together (Fig. 6)
- (3) After completing the "2. System Setup", mount the VFM cover to VFM bracket using the screws provided with VFM (Fig. 7).
- (4) For best results, use the Caddy Snap On Fixture / Box Hanger(512A)

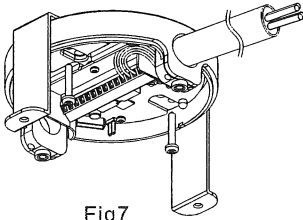

Fig7

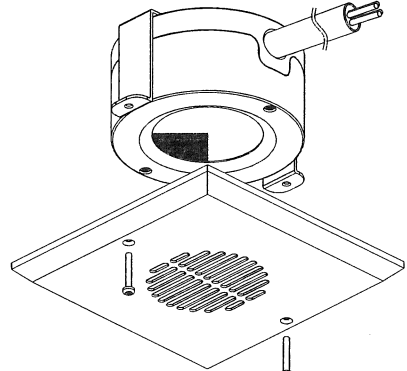
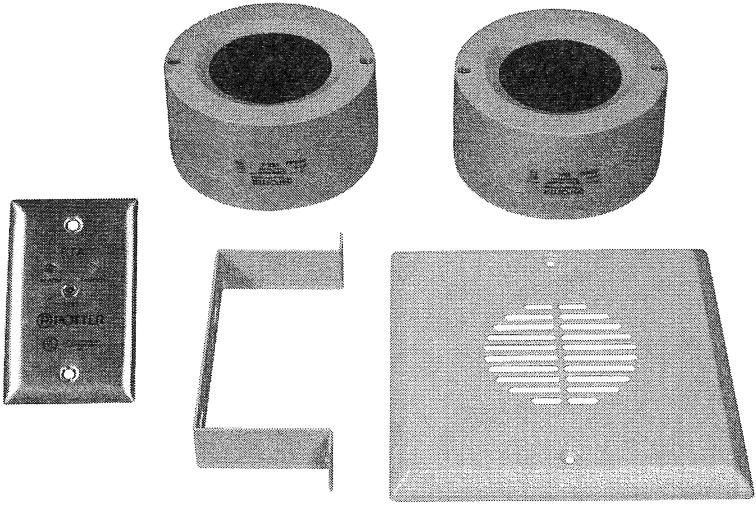

Fig8

Specifications

Dimensions	∅ 5.12" x 3.43"
Weight	VSA-1 - 1.1lb VSM - 0.9lb
Ambient temperature	32°F to 120°F (0°C ~ 49°C)
Output contacts	1 Form C for alarm relay, 2.0 Amps @ 30 VDC 1 Form B for Tamper relay, 2.0 Amps @ 30 VDC
Annunciators	On-board Status LED (not visible through enclosure)
Remote Annunciator: Testing	LEDs for displaying system status and test switch for remote testing.
Testing	Remote connections to a test switch initiates system test for users. On-board test button to facilitate installation.
Accumulator	Integrated into VSA-1 control unit permitting 0-9 accumulated signals.
Balancing	Automatic balancing by pressing a Balancing button
Sensitivity	Manually adjustable to detect all attacks set forth in UL 639 and UL 681 for sound detectors.
Input Power	9.0 VDC to 16.0 VDC, 12 VDC Nominal
Operating current	50mA nominal / 250mA maximum (at test sound generation)
Enclosure	Halogen-free High Impact PC/ABS alloy based enclosures with tamper (VSM don't use tampers as wiring supervisions are provided by VSA-1)
Electrical Connections	Two 1/2" conduit openings
Humidity	85%



® P POTTER
The Symbol of Protection