

EC-3000C/U Series EthernetConnect™ Extender

1, 4, 8, OR 16 PORTS WITH TRUE POE TO 30 WATTS, LOCAL OR REMOTE

Product Features

- Transmits Individual Ethernet Data Channels with Power over Ethernet Plus (PoE+) Power Injection and Pass-Through PoE+ over Standard Cat5/Cat5e/Cat6 UTP Cable or Coaxial Cable
- Extends Ethernet up to 914 m (3,000 ft) at 10 Mbps or 610 m (2,000 ft) at 100 Mbps over Cat5/Cat5e/Cat6 UTP Cable
- Extends Ethernet up to 1,524 m (5,000 ft) at 10 Mbps or 549 m (1,800 ft) at 100 Mbps over Coaxial Cable
- Extended Temperature Operation from -40° to 75°C (-40° to 167°F)
- Extended Pass-Through PoE Meets the IEEE802.3at Standard for Power over Ethernet
- Full 10/100 Mbps Bandwidth
- Supports Multicast, Unicast, and Jumbo Frame
- Symmetric Bandwidth Provides Consistent Upload and Download with Virtually Zero Packet Loss over the Total Usable Distance
- Type Tested to RFC-2544 TCP/IP Network Bandwidth Packet Transmission Standards
- User-Selectable Data Rate for Maximum Bandwidth and Transmission Distance Utilization
- Complies with all Major IEEE Standards and RFC Network Protocols for UDP, TCP/IP, HTTP/HTTPS



- Tested and Certified by an Independent Laboratory for Full Compliance with the Environmental Requirements (Ambient Operating Temperature, Mechanical Shock, Vibration, Humidity with Condensation, High-Line/Low-Line Voltage Conditions, and Transient Voltage Protection) of NEMA TS-1/TS-2 and the Caltrans Specification for Traffic Signal Control Equipment
- LED Status Indicators Confirm Operating Status
- Available in Small Unit Size, Interchangeable Stand Alone, or 1 RU Rack Mounted-Models
- Designed and Manufactured in the USA

The **EC-3000C Series** is ideally suited for applications where the existing coaxial cable needs to be leveraged for transmission of IP signals. For UTP applications, the **EC-3000U Series** is an effective Cat5/Cat5e/Cat6 UTP extender device beyond the 100 m (328 feet) limit of traditional Ethernet. In addition, for system configurations that have a single cable connected to the camera, the **EC-3000C/U Series** can become a true PoE device and source PoE to the powered device. This eliminates the need for midspans or PoE-enabled Ethernet switches to provide a fully 802.3at compatible application. Designed to be a cost-effective, advanced-use product, the **EC-3000C/U Series** provides maximum flexibility in these applications without any programming.

The EthernetConnect™ **EC-3000C/U Series** is used to extend Ethernet over copper (EoC). The **EC-3000C Series** extends up to 16 channels of 10/100 Mbps Ethernet with PoE+ power injection and pass-through PoE+ over coaxial cable. The **EC-3000U Series** extends up to 16 channels of 10/100 Mbps Ethernet with PoE+ power injection and pass-through PoE+ over twisted pair cable (Cat5/Cat5e/6 UTP). With the ability to connect directly to a PoE+ switch or the ability to generate PoE+ power with a 48 V input to either the local or remote ends, these units provide the ultimate flexibility for extending a powered device (PD) over long distance copper.

A complete set includes both a local and a remote module. Remote modules are small unit size in either a one- or four-channel configuration. Local modules are also available in the small unit size in one- or four-channel configuration as well as available in a 1 RU rack size for larger channel counts. All application configurations should be verified at the time of ordering to facilitate ease of installation.



by Schneider Electric

International Standards
Organization Registered Firm;
ISO 9001 Quality System



C3977 / NEW 3-10-14

TECHNICAL SPECIFICATIONS

TYPICAL APPLICATIONS

Note: Coaxial applications use EC-3000C modules; UTP applications use EC-3000U modules.

PoE PASS-THROUGH MODE



REMOTE PoE INJECTION MODE

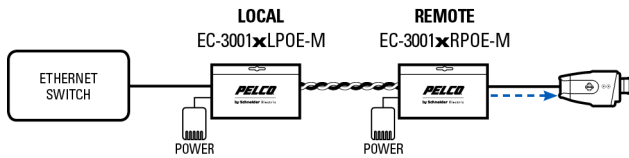

LOCAL PoE INJECTION MODE

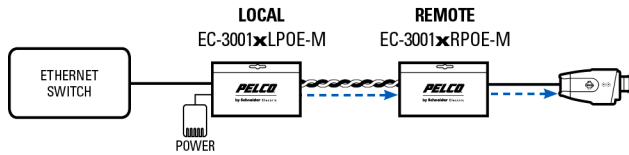

MULTICHANNEL PoE APPLICATION

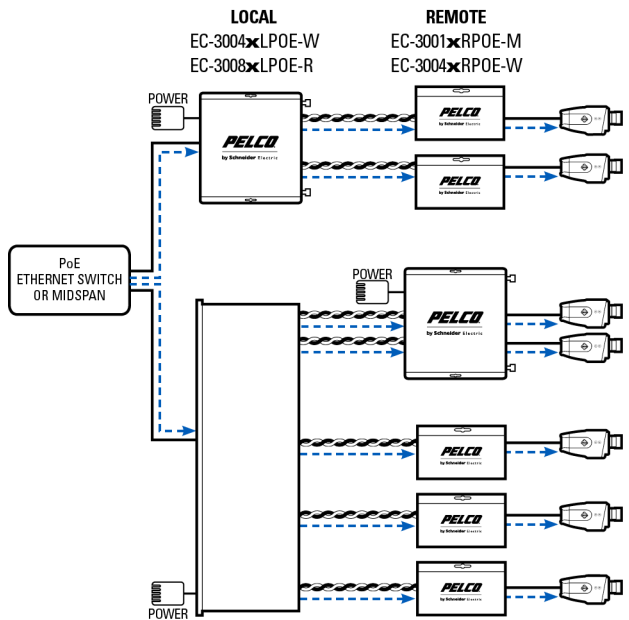

IMPORTANT NOTE. PLEASE READ. The network implementations are shown as general representations only and are not intended to show detailed network topologies. Your actual network will differ, requiring changes or perhaps additional network equipment to accommodate the systems as illustrated. Please contact your local Pelco representative to discuss your specific requirements.

TECHNICAL SPECIFICATIONS

ELECTRICAL

| | |
|----------------------|---------------------------------------------------------------------------------------------|
| Operating Voltage | |
| Pass-Through Mode | |
| 1 CH | N/A; Optional input voltage 12 to 32 VDC or 18 to 32 VAC |
| 4 CH | 12 VDC, 5W; 9 VDC† when in a USRACK or EURACK |
| 8 CH | 12 VDC, 10 W |
| 16 CH | 12 VDC, 20 W |
| Power Injection Mode | |
| 1 CH | 48 to 56 VDC, 30 W |
| 4 CH | 48 to 56 VDC, 120 W |
| 8 CH | 48 to 56 VDC, 240 W |
| 16 CH | 48 to 56 VDC, 480 W |
| Current Protection | Automatic resettable solid-state current limiters |
| MTBF | >100,000 hours |
| LED Indicators | Operating power; PoE power; Ethernet link and activity; extended link and activity |

DATA

| | |
|----------------|---------------------------------------------------------------------------------------------------|
| Data Interface | 10/100Base-T Ethernet |
| Data Rate | DIP switch selectable 10/100 Mbps; full data rate/full-duplex up to the maximum rated distance |
| RFC | 2544 TCP/IP packet transmission |
| Standards | |
| PoE+ | IEEE802.3af/at |
| RFC | 768 UDP, 2068 HTTP, 793 TCP, 791 IP, 1783 TFTP, 894 IP over Ethernet |

Maximum Transmission Distances

| Media | COAX-RG59/U | | | | UTP, 4 Pair | | | |
|------------------------------------------------------------|-----------------------|-------------------|---------------------|-------------------|---------------------|-------------------|---------------------|-------------------|
| | 10 Mbps | | 100 Mbps | | 10 Mbps | | 100 Mbps | |
| Camera Data Rate | 10 Mbps | | 100 Mbps | | 10 Mbps | | 100 Mbps | |
| Source Power | 15 W | 30 W | 15 W | 30 W | 15 W | 30 W | 15 W | 30 W |
| Non-PoE Camera* | 1,524 m (5,000 ft) | | 549 m (1,800 ft) | | 914 m (3,000 ft) | | 610 m (2,000 ft) | |
| Remote Injection* | 1,524 m (5,000 ft) | | 549 m (1,800 ft) | | 914 m (3,000 ft) | | 610 m (2,000 ft) | |
| PoE CLASS2 Camera (6.5 W)* | 914 m (3,000 ft) | | 549 m (1,800 ft) | | 914 m (3,000 ft) | | 610 m (2,000 ft) | |
| PoE CLASS3 Camera (13 W)* (10 W in pass-through mode) | 259 m (850 ft) | 259 m (850 ft) | 259 m (850 ft) | 259 m (850 ft) | 259 m (850 ft) | 259 m (850 ft) | 259 m (850 ft) | 259 m (850 ft) |
| PoE CLASS4 Camera (25.5 W)* (22 W in pass-through mode) | N/A | 102 m (335 ft) | N/A | 102 m (335 ft) | N/A | N/A | N/A | N/A |

*Distance figures are based on a 50 V PSE PoE power source, and external power supplies for the extenders. Distance figures are obtained using in-house testing mirroring installations. Factors such as coaxial and copper cable quality, the number of connectors and splices in the cable run, the use of PoE, and environmental conditions encountered within the installation might affect the actual transmission distance and should be taken into consideration.

MECHANICAL

| | |
|--------------------|------------------------------------------|
| Connectors | |
| Ethernet | RJ-45 |
| Extended Interface | |
| Coaxial | Female BNC |
| UTP | RJ-45 |
| Operating Power | Powered by PoE or two-pin screw terminal |

GENERAL

| | |
|-----------------------|------------------------------------------------------|
| Dimensions | |
| 1 CH | 8.4 x 6.4 x 2.8 cm (3.3" D x 2.5" W x 1.1" H) |
| 4 CH | 15.5 D x 13.5 x 2.8 cm (6.1" x 5.3" W x 1.1" H) |
| 8 CH | 15.5 x 48.26 x 4.45 cm (6.1" D x 19" W x 1.75" H) |
| 16 CH | 15.5 x 48.26 x 4.45 cm (6.1" D x 19" W x 1.75" H) |
| Operating Temperature | -40° to 75°C (-40° to 167°F) |
| Storage Temperature | -40° to 80°C (-40° to 176°F) |
| Relative Humidity | 0% to 95%, noncondensing |
| Shipping Weight | |
| 1 CH | <0.5 kg (1 lb) |
| 4 CH | <0.9 kg (2 lb) |
| 8 CH | <2.3 kg (5 lb) |
| 16 CH | <2.3 kg (5 lb) |

CERTIFICATIONS/RATINGS

- CE, Class A
- FCC, Part 15, Class A
- UL/cUL Listed
- C-Tick
- Designed to meet NEMA TS-1/TS-2 and the Caltrans traffic signal control equipment environmental standards

RECOMMENDED ACCESSORIES

| | |
|------------------|-----------------------------------------------------------------------------------------------------------------------------------------------------------|
| ECPS-12VDC-0.5A† | EthernetConnect 12 VDC, 0.5 A power supply for non-pass-through mode applications |
| ECPS-12VDC-3A† | EthernetConnect 12 VDC, 3 A power supply for non-PoE pass-through mode applications on EC-3008CLPOE-R, EC-3008ULPOE-R, EC-3016CLPOE-R, and EC-3016ULPOE-R |
| FEXTPS-48V† | EthernetConnect 48 VDC, 1.36 A power supply for power injection mode applications |
| ECPS-48VDC-5A† | EthernetConnect 48 VDC, 5 A power supply for power injection mode applications |
| ECPS-48VDC-10A† | EthernetConnect 48 VDC, 10 A power supply for power injection mode applications |
| USRACK† | Rack-mount chassis, 14-slot, 9 VDC, 6.5 A, internal power supply, US power cord |
| EURACK† | Rack-mount chassis, 14-slot, 9 VDC, 6.5 A, internal power supply, EU power cord |
| RACK1B | Single-width blank module for empty rack slots |

†Contact Pelco pre-sales support, or refer to the appropriate installation and operation manual when configuring and specifying power for a deployment.

TECHNICAL SPECIFICATIONS

MODELS

EC-3000C SERIES (COAXIAL CABLE)

Local

| | |
|----------------|-------------------------------------------------------------------------------------------------------------------------------------|
| EC-3001CLPOE-M | EthernetConnect local single-port coaxial extender with true PoE to 30 W, EoC using coaxial cable, mini case, 12 VDC/48 VDC, 24 VAC |
| EC-3004CLPOE-W | EthernetConnect local 4-port coaxial extender with true PoE to 30 W, EoC using coaxial cable, wall-mount |
| C-3008CLPOE-R | EthernetConnect local 8-port coaxial extender with true PoE to 30 W, EoC using coaxial cable, 1 RU rack-mount |
| EC-3016CLPOE-R | EthernetConnect local 16-port coaxial extender with true PoE to 30 W, EoC using coaxial cable, 1 RU rack-mount |

Remote

| | |
|----------------|--------------------------------------------------------------------------------------------------------------------------------------|
| EC-3001CRPOE-M | EthernetConnect remote single-port coaxial extender with true PoE to 30 W, EoC using coaxial cable, mini case, 12 VDC/48 VDC, 24 VAC |
| EC-3004CRPOE-W | EthernetConnect remote 4-port coaxial extender with true PoE to 30 W, EoC using coaxial cable, wall-mount |

EC-3000U SERIES (UTP CABLE)

Local

| | |
|----------------|---------------------------------------------------------------------------------------------------------------------------------------|
| EC-3001ULPOE-M | EthernetConnect local single-port UTP extender with true PoE to 30 W, EoC using Cat5/Cat5e/Cat6 UTP, mini case, 12 VDC/48 VDC, 24 VAC |
| EC-3004ULPOE-W | EthernetConnect local 4-port UTP extender with true PoE to 30 W, EoC using Cat5/Cat5e/Cat6 UTP, wall-mount |
| EC-3008ULPOE-R | EthernetConnect local 8-port UTP extender with true PoE to 30 W, EoC using Cat5/Cat5e/Cat6 UTP, 1 RU rack-mount |
| EC-3016ULPOE-R | EthernetConnect local 16-port UTP extender with true PoE to 30 W, EoC using Cat5/Cat5e/Cat6 UTP, 1 RU rack-mount |

Remote

| | |
|----------------|----------------------------------------------------------------------------------------------------------------------------------------|
| EC-3001URPOE-M | EthernetConnect remote single-port UTP extender with true PoE to 30 W, EoC using Cat5/Cat5e/Cat6 UTP, mini case, 12 VDC/48 VDC, 24 VAC |
| EC-3004URPOE-W | EthernetConnect remote 4-port UTP extender with true PoE to 30 W, EoC using Cat5/Cat5e/Cat6 UTP, wall-mount |

FRONT AND REAR PANEL LAYOUTS (COAXIAL)

SINGLE-CHANNEL COAXIAL UNITS

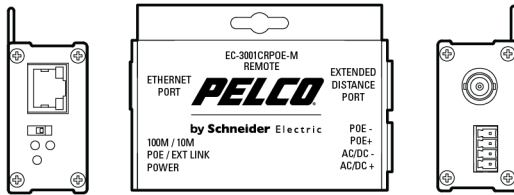

FRONT AND REAR PANEL LAYOUTS (UTP)

SINGLE-CHANNEL UTP UNITS

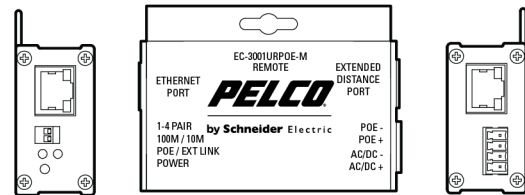

FOUR-CHANNEL SURFACE OR RACK MOUNT COAXIAL UNITS

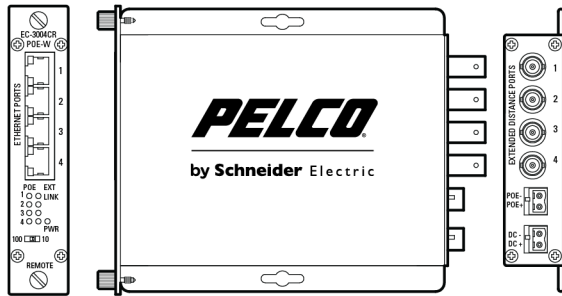

FOUR-CHANNEL SURFACE OR RACK MOUNT UTP UNITS

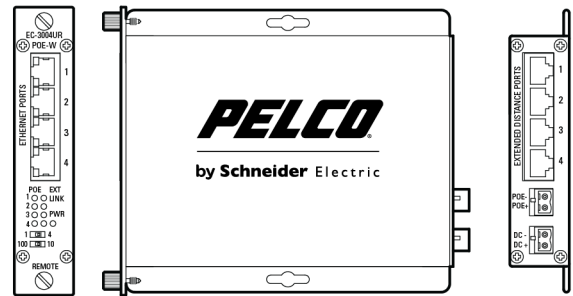

MULTICHANNEL RACK COAXIAL UNITS

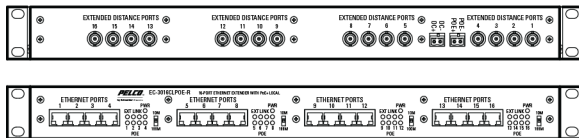

MULTICHANNEL RACK UTP UNITS

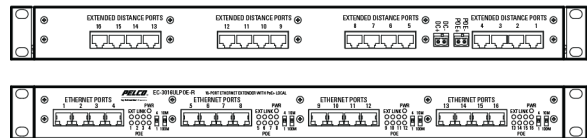

Pelco by Schneider Electric

3500 Pelco Way, Clovis, California 93612-5699 United States
USA & Canada Tel (800) 289-9100 Fax (800) 289-9150
International Tel +1 (559) 292-1981 Fax +1 (559) 348-1120
www.pelco.com www.pelco.com/community

Pelco, the Pelco logo, and other trademarks associated with Pelco products referred to in this publication are trademarks of Pelco, Inc. or its affiliates. ONVIF and the ONVIF logo are trademarks of ONVIF Inc. All other product names and services are the property of their respective companies. Product specifications and availability are subject to change without notice. ©Copyright 2014, Pelco, Inc. All rights reserved.