



BOSCH

FLEXIDOME IP starlight 6000 VR

NIN-63013 | NIN-63023

Installation manual

en

english

Table of contents

1	Safety	4
1.1	Safety precautions	4
2	Short information	5
3	System overview	6
3.1	Performance	6
3.2	Using the camera	6
3.3	Application variants	7
4	Planning information	8
4.1	Unpacking	8
4.2	Contents	8
5	Installation	9
5.1	Preparation	9
5.2	Local storage	9
5.3	Wiring	10
5.3.1	Cable tree	10
5.3.2	Earthing	10
5.3.3	Network (and PoE power)	10
5.3.4	Auxiliary power	11
5.3.5	Alarm	11
5.3.6	Audio	11
5.3.7	Video	11
5.4	Mounting the camera module	12
5.4.1	Mounting flush to ceiling	12
5.4.2	Mounting to ceiling with SMB-IP	13
5.5	Camera positioning and field-of-view	14
5.5.1	Pan	14
5.5.2	Tilt	14
5.5.3	Twist	15
5.6	Local set-up	15
5.6.1	Using the install wizard	15
5.6.2	Reset	16
5.7	Mount inner and outer dome	16
6	Connection via web browser	18
7	Configuration	19
8	Troubleshooting	20
8.1	Resolving problems	20
8.2	Testing the network connection	21
8.3	Customer service	21
9	Maintenance	22
9.1	Cleaning	22
9.1.1	Lens cleaning	22
9.2	Repair	22
10	Decommissioning	23
10.1	Transfer	23
10.2	Disposal	23
11	Technical data	24

1 Safety

**Caution!**

Indicates a hazardous situation which, if not avoided, could result in minor or moderate injury.

**Notice!**

Indicates a situation which, if not avoided, could result in damage to the equipment or environment, or data loss.

1.1 Safety precautions

**Caution!**

The Low Voltage power supply unit must comply with EN/UL 60950. The power supply must be a SELV-LPS unit or a SELV - Class 2 unit (Safety Extra Low Voltage - Limited Power Source).

**Caution!**

Installation should only be performed by qualified service personnel in accordance with the National Electrical Code (NEC 800 CEC Section 60) or applicable local codes.

Read, follow, and retain for future reference all of the following safety instructions. Follow all warnings before operating the device.

1. Clean only with a dry cloth. Do not use liquid cleaners or aerosol cleaners.
2. Do not install device near any heat sources such as radiators, heaters, stoves, or other equipment (including amplifiers) that produce heat.
3. Never spill liquid of any kind on the device.
4. Take precautions to protect the device from power and lightning surges.
5. Adjust only those controls specified in the operating instructions.
6. Operate the device only from the type of power source indicated on the label.
7. Unless qualified, do not attempt to service a damaged device yourself. Refer all servicing to qualified service personnel.
8. Install in accordance with the manufacturer's instructions in accordance with applicable local codes.
9. Use only attachments/accessories specified by the manufacturer.
10. Protect all connection cables from possible damage, particularly at connection points.
11. Connect the yellow/green earth wire of the camera to the system earth of the installation to ensure correct safety and EMC/RFI protection.

2 Short information

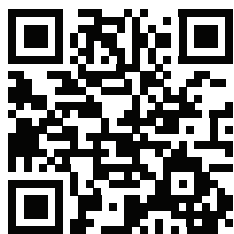

http://www.boschsecurity.com/catalog_overview.htm

This manual has been compiled with great care and the information it contains has been thoroughly verified. The text was correct at the time of printing, however, the content can change without notice. Bosch Security Systems accepts no liability for damage resulting directly or indirectly from faults, incompleteness or discrepancies between this manual and the product described.

For more information please contact the nearest Bosch Security Systems location or visit www.boschsecurity.com

All hardware and software product names used in this document are likely to be registered trademarks and must be treated accordingly.

3 System overview

3.1 Performance

This camera provides clear images 24/7 – even at night or under low-light conditions. The exceptional starlight sensitivity enables this camera to work with a minimum of ambient light. The extended dynamic mode provides detailed images in scenes with challenging lighting.

The camera is available in 1080p or 720p resolution versions and provides up to 60 images per second.

The aesthetic vandal-resistant housing makes the camera suitable for indoor or outdoor installation.

3.2 Using the camera

Use a web browser to access the camera features and to view the camera streams live. Use the same browser interface to access and change the camera configuration parameters and recording/storage functions (including local alarm recording, and recording to iSCSI-based systems).

Refer to the software manual for more information on the browser interface.

The web browser is the most direct way of using the camera, however, the Bosch download store provides several other free applications (listed below) for viewing and controlling the camera.

Download store

Download the latest applications and firmware from:

<http://downloadstore.boschsecurity.com/>



Video Security Client

The Video Security Client is a free, easy-to-use video-surveillance application provided by Bosch for local and remote monitoring of IP cameras and appliances. The software supports up to 16 cameras.

Bosch Video Client

The Bosch Video Client is a free Windows application to view, operate, control, and administer surveillance cameras and installations at remote locations. It offers a user-friendly interface for easy live viewing of multiple cameras, playback, forensic search and export.

IP Helper

The IP Helper tool is a free PC application that makes it easy to detect Bosch cameras and devices on your network.

Video security app

The Bosch video security mobile app has been developed to enable Anywhere access to HD surveillance images allowing you to view live images from any location. The app is designed to give you complete control of all your cameras, from panning and tilting to zoom and focus functions. It's like taking your control room with you.

This app, together with the separately available Bosch transcoder, will allow you to fully utilize our dynamic transcoding features so you can play back images even over low-bandwidth connections.

3.3 **Application variants**

The camera has a choice of application variants that set up the camera for optimum performance in a specific environment. Select the application variant best suited to your installation.

The application variant must be selected before any other changes are made, as the camera reboots automatically and resets the factory defaults when the application variant is changed.

This camera has the following application variants:

- Starlight mode (default) – to continue viewing in color at very low light levels
- Extended Dynamic mode - simultaneously see details in very bright and very dark objects in the same scene

4 Planning information

4.1 Unpacking

This equipment should be unpacked and handled with care. If an item appears to have been damaged in shipment, notify the shipper immediately.

Verify that all parts are included. If any items are missing, notify your Bosch Security Systems Sales or Customer Service Representative.

The original packaging is the safest container in which to transport the unit and can be used if returning the unit for service.

4.2 Contents

The packaging contains:

Quantity	Component
1	FLEXIDOME IP camera
1	T-25H security torx bit
3	Screws (5 REF pozidrive DIN7505-B 50 mm)
3	Wall plugs (8 x 40 mm)
1	Installation Guide
1	Identification label sheet
1	RJ45 shielded coupler
1	Desiccant sachet

The version of the camera with surface mount box contains:

Quantity	Component
1	Surface mount box with RJ45 connection box
3	Screws (M5 x 16 mm)
1	Rubber grommet for RJ45 connection box

5 Installation

5.1 Preparation

To separate the different parts of the camera:

1. Remove the outer dome by unscrewing the 3 attachment bolts.
2. Remove the inner dome by gently pulling it from its mount seal.
3. Store the domes in a safe place where the outer dome cannot become scratched.
4. Remove the camera module from the surface mount box by unscrewing the 3 screws.

To remove the desiccant sachet:

1. Slide the sachet out of its storage slot in the camera.
2. Dispose of the sachet in an environmentally friendly way.

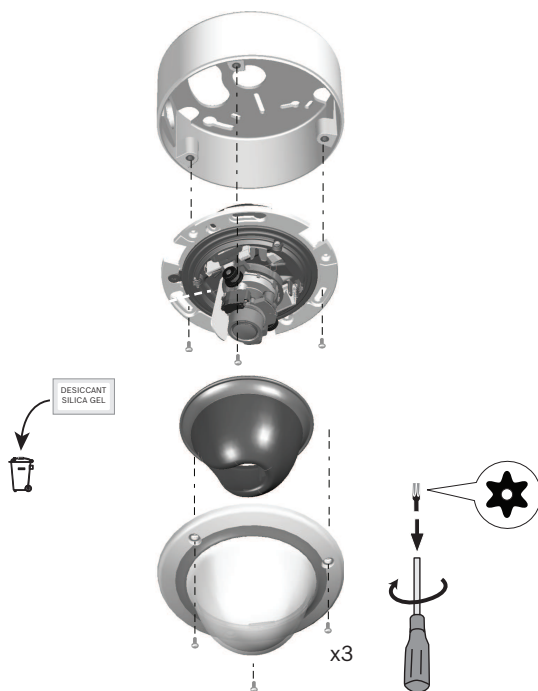

5.2 Local storage



Notice!

Local storage on memory cards should only be used for alarm recording. To minimize the risk of losing information, use multiple, redundant recording systems and a procedure to back up all digital information.

To insert a memory card:

1. Slide the memory card into the slot.
2. Press it firmly until it latches into place in the slot (when removing the card, press it down firmly again until it unlatches).

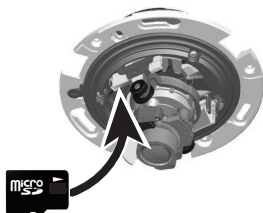

5.3 Wiring



Caution!

The unit has connection terminals on flying leads. In wet or outdoor installations, use a field wiring box with NEMA Type 4X or IP66 protection level or better. After connections are made, ensure the watertight compartment is tightly closed and cables and conduits are properly sealed to prevent water ingress.



Notice!

Use proper surge suppression on cables that are routed outdoors, or close to large inductive loads or electrical mains supply cables.

5.3.1

Cable tree

Use the following table to identify the wires in the cable tree:

Wire color	AWC	Signal
Red	26	+12 VDC
Brown	26	-12 VDC
Yellow / Green	24	Earth
Black / Orange	28	Alarm Out A
White / Orange	28	Alarm Out B
White / Violet	28	Ground (Alarm In)
Orange / Violet	28	Alarm In 1
Violet	28	Alarm In 2
White	28	Audio In
(Shield)	28	Ground (Audio)
Black	28	Audio Out
BNC connector		CVBS analog

5.3.2

Earthing



Caution!

This device must be connected to earth (ground).

Safety (power) ground is indicated by the  symbol.

Connect the yellow/green wire of the camera to the system earth of the installation to ensure correct safety and EMC/RFI protection.

5.3.3

Network (and PoE power)

Connect the camera to a 10/100 Base-T network:

- Use STP Category 5e cable with RJ45 connectors (the camera network socket is Auto MDIX compliant).
- Power is supplied to the camera via the Ethernet cable compliant with the Power-over-Ethernet standard.

**Notice!**

Use only PoE approved devices.

Power-over-Ethernet can be connected at the same time as a 12 VDC power supply. If auxiliary power (12 VDC) and PoE is applied simultaneously, the camera selects PoE and shuts off the auxiliary input.

5.3.4**Auxiliary power**

Connect a SELV-LPS or a SELV Class 2 power supply with a rated supply voltage of 12 VDC as follows:

- Cut back 7 mm (0.28 in) of insulation.
- Connect the power wires (red+ , brown-) to the external power supply.

**Caution!**

Use **only** a +12 VDC power supply as an auxiliary power source.
The auxiliary power supply unit must be isolated from earth.

5.3.5**Alarm**

Use the stranded and solid wires with maximum diameter AWG 22-28; only cut back 5 mm (0.2 in) of insulation.

Alarm out:

Use the alarm output for switching external devices such as lamps or sirens.

The alarm output switching capability has max. voltage 30 VAC or +40 VDC; max. 0.5 A continuous, 10 VA.

Alarm in:

Use the alarm input to connect external alarm devices such as door contacts or sensors:

- TTL logic, +5 V nominal, +40 VDC max, DC coupled with 50 kOhm pull-up to +3.3 V.
- Configurable as active low or active high.

Use a zero potential make-contact or switch as the actuator (with a bounce-free contact system).

5.3.6**Audio**

Connect audio devices to the audio input and audio output connectors.

The unit has full-duplex mono audio for two-way communication between a speaker or door intercom system. The audio input signal is transmitted in sync. with the video signal.

Audio input:

Line input level (not suitable for direct microphone signal); impedance 18 kOhm typical; 1 Vrms maximum input voltage.

Audio output:

Line output level (not suitable for direct speaker connection); impedance 1.5 kOhm minimum; 0.85 Vrms maximum output voltage.

Use shielded audio connection cable with advised maximum cable lengths for audio line input and output levels.

5.3.7**Video**

Use the composite video connector (CVBS) on the camera to connect an analog monitor for setting up the camera or as a permanent analog output for viewing or recording:

- To connect a monitor for set-up, use the optional 3 m cable (NBN-MCSMB-30M) to connect directly to the CVBS connector of a monitor.
- For a permanent analog output, use the optional 0.3 m cable (NBN-MCSMB-03M) to connect to a high quality coax cable.

5.4 Mounting the camera module

5.4.1 Mounting flush to ceiling

To mount the camera flush to the ceiling:

1. Mark out the recess hole and the three mounting holes. The mounting holes are equally spaced around a diameter of 133 mm (5.25 in).
2. Cut out the inner recess hole: Ø105 mm (4.13 in).
3. Use a 8 mm (0.31 in) bit to drill the three mounting holes
4. Insert the supplied mounting plugs (8 x 40) into the mounting holes.
5. Use the supplied screws (DIN7505-B 50mm) to securely mount the camera to the ceiling surface; if the ceiling is too thin, use appropriate ceiling bolts (not supplied).

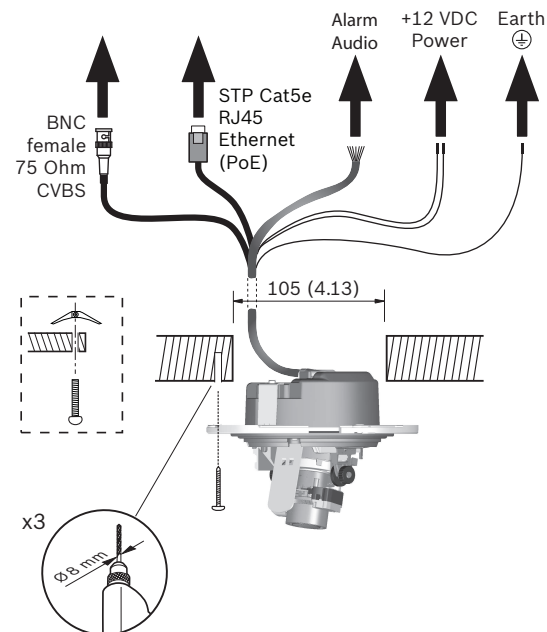
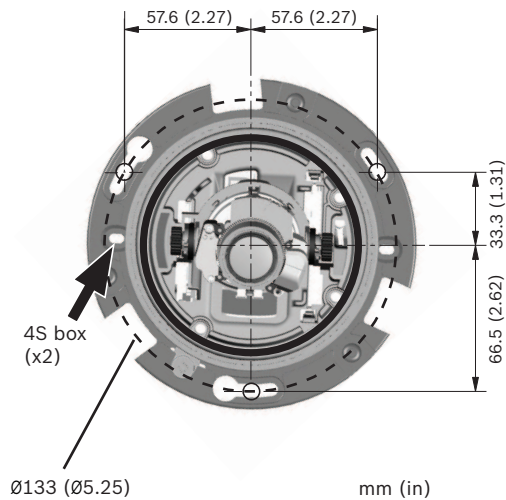

Note:

If using a recessed 4s mounting box, attach the camera to the box using two screws and washers (M4 x 14).

5.4.2 Mounting to ceiling with SMB-IP

To mount the camera using a Surface Mount Box and cable conduit:

1. Use the SMB to mark out the cable hole in the ceiling and to mark the three mounting holes. The mounting holes are equally spaced around a diameter of 133 mm (5.25 in).
2. Cut out the cable hole in the ceiling, and use a 8 mm (0.31 in) bit to drill the three mounting holes.
3. Insert the supplied mounting plugs (8 x 40) into the mounting holes.
4. Use the supplied screws (pozidrive DIN7505-B 50mm) to securely attach the SMB to the surface.
5. Feed the Ethernet RJ45 cable from source through the ceiling into the SMB
6. Remove the cover from the SMB cable conduit and slide out the rubber seals at either end.
7. Thread the Ethernet cables from the camera and source through the seals (they can be pulled open to fit the cables). If required, use the larger bore seal (supplied in parts package) to fit thicker cables.
8. Slot the seals (with cables) into either end of the conduit.
9. Connect the Ethernet cables inside the conduit using the supplied RJ45 shielded connector.
10. Close the cover on the conduit and position the conduit inside the SMB.
11. Feed the other camera cabling through the cable hole in the SMB.
12. If IP66 water ingress protection is required, connect the camera cabling to the source cabling inside an IP66 approved box.
13. Mount the camera to the SMB using the 3 supplied screws (M5x16mm torx).

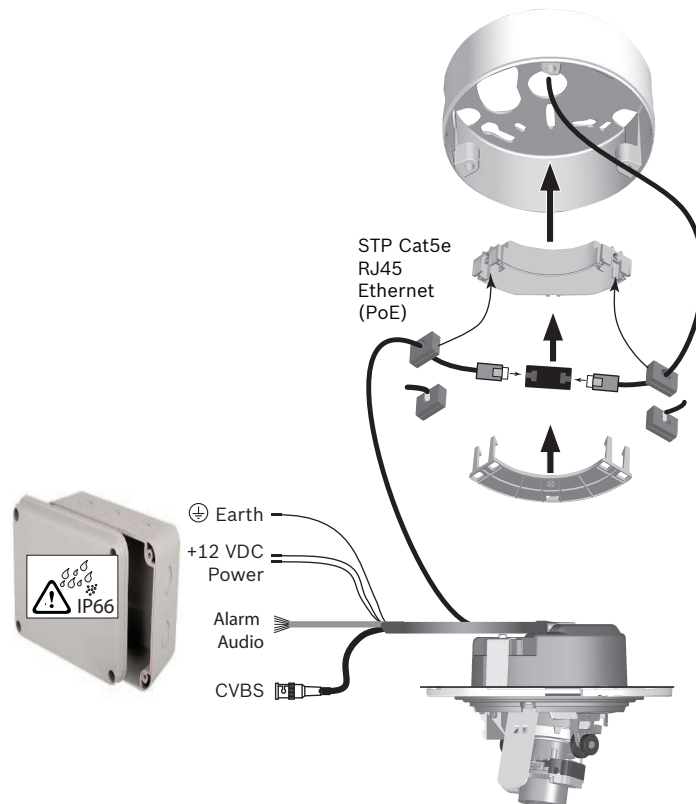

5.5 Camera positioning and field-of-view

The camera module position can be adjusted along three axes and several zoom positions can be selected.

To help position the camera and set the field-of-view:

1. Connect a monitor to the 2.5 mm jack using the optional monitor cable (S1460) which provides a CVBS signal (for installation purposes only).
2. Apply power to the camera.
3. After power-up, wait a little (about 20 seconds).
4. Press the Menu button. This stops the IP video stream and enables the service video analog output.

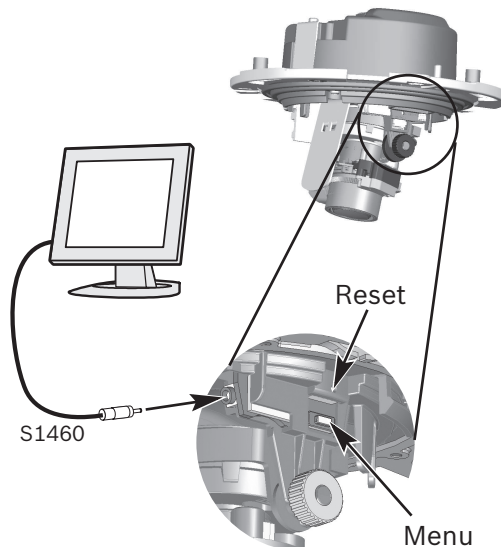

Notice!

Do not expose the image sensors to direct sunlight.

5.5.1

Pan

For horizontal adjustment (pan):

1. Rotate the camera module (1) in the base. Do not rotate more than 180° in either direction.
2. Tighten the locking screw (2) with the supplied screwdriver bit.

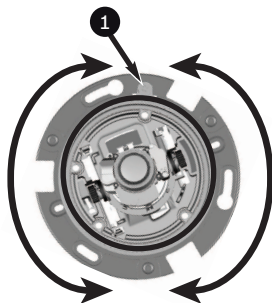

5.5.2

Tilt

For vertical adjustment (tilt):

1. Loosen the two thumbwheels (1).
2. Swing the camera module between the wings. Do not rotate more than 90°.

3. Tighten the two thumbwheels (1).

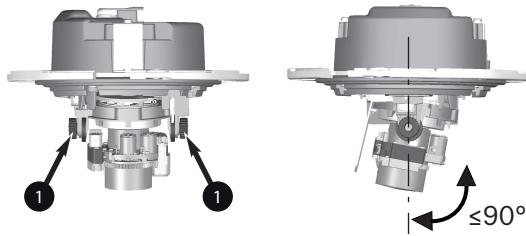

5.5.3

Twist

To obtain a horizontal horizon (for tilted ceilings or sidewall mounting), twist the camera module to align the picture shown on the monitor.

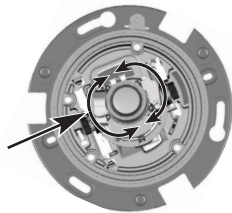

5.6

Local set-up

The **Menu** button on the control panel is used to access the camera install wizard. When there is a choice in the wizard, the options are selected by either a short press (less than 2 s) or a long press (more than 2 s) of the **Menu** button.

Use the install wizard for the following functions:

- Choose application variant
- Change image orientation
- Activate automatic back focus
- Choose analog output

Note:

The zoom and focus are adjusted again later (with the dome bubble in place) via the web browser. This optimizes picture sharpness in both bright and low-level lighting.

5.6.1

Using the install wizard

To perform the set-up:

1. Power-up the camera and wait briefly until all LEDs show green.
2. Open the camera install wizard by pressing the **Menu** button.
3. To change the variant, briefly press **Menu** a number of times until the desired variant is shown (remember that changing the variant will reboot the system and may eventually need a reset to return to factory defaults).
4. To confirm the selected variant, press **Menu** for a longer time.
5. To rotate the image 180°, press and hold **Menu** until the image flips.
6. Briefly press the **Menu** button to set the start position for the automatic motorized focus adjustment.
 - You will hear the motorized automatic back focus process running.
 - The progress is shown on the monitor.
7. Briefly press the **Menu** button again and again to scroll through the preset zoom positions.
 - The selection loops back to the beginning when you reach the last one.

8. When you reach the desired zoom position, use a long press of the **Menu** button to set the zoom position and to re-focus.
9. If the camera is not in focus, press **Menu** for a longer time to re-run the auto focus.
10. If the camera is correctly focused, briefly press the **Menu** button to access the video analog output format screen.
11. Briefly press **Menu** to change the video analog output format as required.
12. When the correct format is shown, press **Menu** for a longer period to exit the wizard.

5.6.2

Reset

Use the factory reset button to restore the unit to its original settings. Any changes to the settings are overwritten by the factory defaults. A reset may be necessary, for example, if the unit has invalid settings that prevent it from functioning as desired.

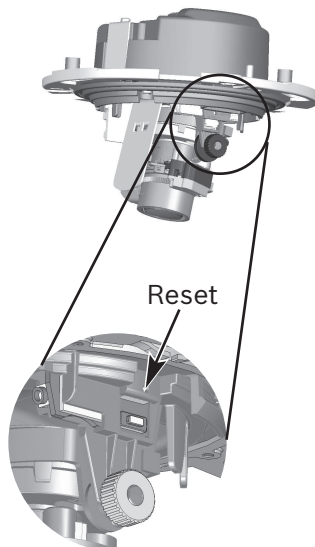

5.7

Mount inner and outer dome

When the camera position is set and all adjustments have been made, disconnect the service cable from the video jack.

To attach the inner and outer dome:

1. Place the desiccant sachet inside the inner dome to prevent damp.
2. Align the inner dome fin with the slot in the camera frame, and gently click the inner dome into place in its mount seal
3. Check that the lens can move freely in the dome opening.
4. Mount the outer dome by screwing in the 3 attachment bolts.

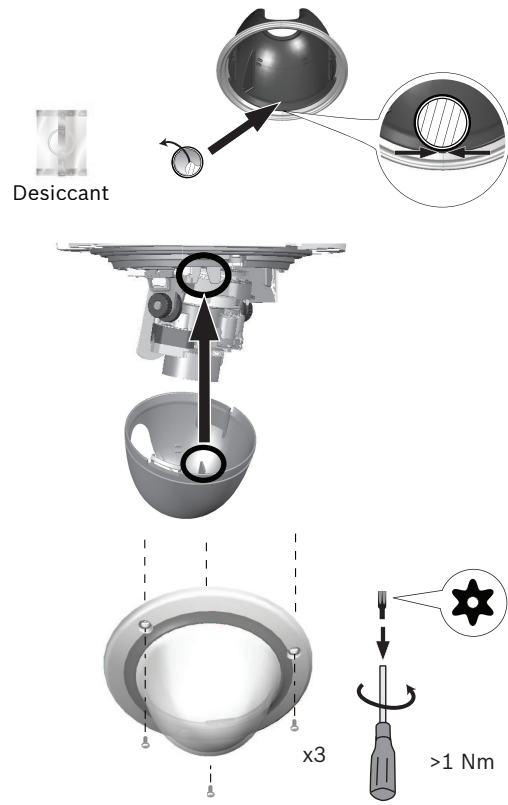

6 Connection via web browser

The unit must have a valid IP address and a compatible subnet mask to operate on your network. By default, DHCP is pre-set at the factory to **On** and so your DHCP server assigns an IP address. With no DHCP server the default address is 192.168.0.1

To view the camera in your web browser:

1. Start the Web browser.
2. Enter the IP address of the unit as the URL.
3. During initial installation, confirm any security questions that appear.

Note:

To see live images in your browser it might be necessary to download and install the MPEG-ActiveX from the Bosch download store.

Protected Network

If a RADIUS server is used for network access control (802.1x authentication), the unit must be configured first. To configure the unit, connect it directly to a computer using a network cable and configure the two parameters, **Identity** and **Password**. Only after these have been configured can communication with the unit via the network occur.

IP Helper tool

Alternatively, use the IP Helper tool to detect Bosch devices on the network:

1. Access the Bosch download store (<http://downloadstore.boschsecurity.com/>).
2. Download and install IP Helper.
3. Choose your specific camera from the list of cameras shown in the table on the left of the screen
4. Click **Open in browser** to view the camera interface.

7 Configuration

The camera normally provides an optimal picture without the need for further adjustments. However, you can use a web browser via the network to access a menu to change camera settings such as user modes, passwords, picture settings and network settings.

Configuration options using the menu system on the camera itself are limited to basic setup via the Wizard.

1. Open the camera in the web browser.
2. Click **Configuration** in the title bar.
3. Select **Camera >> Installer Menu** from the side bar.
4. Select the application variant before any other changes are made, as the camera reboots automatically and resets the factory defaults when the application variant is changed.

If required, configure the parameters in other menus to suit your working environment (for example, ID, passwords, date and time). Refer to the operation manuals of the software for more information.

8 Troubleshooting

8.1 Resolving problems

The following table is intended to help identify the causes of malfunctions and correct them where possible.

Malfunction	Possible causes	Solution
Unit does not operate.	Power failure.	Check power supply.
	Faulty cable connections.	Check all cables, plugs, contacts and connections.
No connection established, no image transmission.	Incorrect unit configuration.	Check all configuration parameters (reset to factory default if necessary).
	Faulty installation.	Check all cables, plugs, contacts and connections.
	Wrong IP address.	Check the IP addresses (ping).
	Faulty data transmission within the LAN.	Check the data transmission with ping.
	The maximum number of connections has been reached.	Wait until there is a free connection and call the transmitter again.
No audio transmission to remote station.	Hardware fault.	Check that all connected audio units are operating correctly.
	Faulty cable connections.	Check all cables, plugs, contacts and connections.
	Incorrect configuration.	Check audio parameters on the Audio configuration and LIVE page functions pages.
	The audio voice connection is already in use by another receiver.	Wait until the connection is free and then call the sender again.
The unit does not report an alarm.	Alarm source is not selected.	Select possible alarm sources on the Alarm sources configuration page.
	No alarm response specified.	Specify the desired alarm response on the Alarm connections configuration page; if necessary change the IP address.
The unit is not operational after a firmware upload.	Power failure during programming by firmware file.	Have the unit checked by Customer Service and replace if necessary.

	Incorrect firmware file.	Enter the IP address of the unit followed by /main.htm in your Web browser and repeat the upload.
Web browser contains empty fields.	Active proxy server in network.	Create a rule in the local computer's proxy settings to exclude local IP addresses.

8.2 Testing the network connection

The ping command can be used to check the connection between two IP addresses. This allows testing whether a device is active in the network.

1. Open the DOS command prompt.
2. Type `ping` followed by the IP address of the device.

If the device is found, the response appears as "Reply from ... ", followed by the number of bytes sent and the transmission time in milliseconds. Otherwise, the device cannot be accessed via the network. This might be because:

- The device is not properly connected to the network. Check the cable connections in this case.
- The device is not correctly integrated into the network. Check the IP address, subnet mask, and gateway address.

8.3 Customer service

If a fault cannot be resolved, please contact your supplier or system integrator, or go directly to Bosch Security Systems Customer Service.

The version numbers of the internal firmware can be viewed on a service page. Please note this information before contacting Customer Service.

1. In the address bar of your browser, after the unit IP address, enter: `/version` for example: `192.168.0.80/version`
2. Write down the information or print out the page.

9 Maintenance

9.1 Cleaning

It is generally sufficient to use a dry cloth for cleaning, but a moist lint-free cloth or leather shammy may also be used.

Do not use liquid cleaners or aerosol cleaners.

9.1.1 Lens cleaning

It is important to keep the lens clean to ensure optimum performance. Dust, grease, or fingerprints should be removed from the lens surface. When cleaning the lens, take extra care not to damage the special coating used to reduce light reflections.

- Remove dust with a blower-brush or grease-free soft brush.
- Wipe water drops off the lens with a clean soft lint-free cloth and dry the lens surface.
- Use special lens cleaning paper or cloth treated with lens cleaning fluid to gently wipe off any remaining dirt (wipe spirally from the lens center towards the edge).

9.2 Repair

**Notice!**

Never open the casing of the unit

The unit does not contain any user-serviceable parts. Refer all repairs to suitable qualified specialists.

10 Decommissioning

10.1 Transfer

The unit should only be passed on together with this installation guide.

10.2 Disposal



Disposal - Your Bosch product was developed and manufactured with high-quality material and components that can be recycled and reused. This symbol means that electronic and electrical appliances, which have reached the end of their working life, must be collected and disposed of separately from household waste material. Separate collecting systems are usually in place for disused electronic and electrical products. Please dispose of these units at an environmentally compatible recycling facility, per *European Directive 2012/19/EU*.

11 Technical data

Power	
Input voltage	Power-over-Ethernet (48 VDC nominal) and/or +12 VDC \pm 10% (auxiliary)
PoE IEEE standard	802.3af (802.3at Type 1) Power level: Class 3
Power Consumption	7.2 W max.
Current draw (PoE)	200 mA max.
Current draw (12 VDC)	600 mA max.
Mechanical	
Dimensions (D x H)	158 x 124 mm (6.22 x 4.89 in)
Weight	0.85 kg (1.87 lb) 1.28 kg (2.82 lb) with SMB
Mounting	Flush mount or surface mount
Color	White (RAL9010) trim ring with black inner liner
Adjustment range	360° pan, 90° tilt, \pm 90° twist
Dome bubble	Polycarbonate, clear with UV blocking anti-scratch coating
Trim ring	Aluminum
Environmental	
Operating temperature	-30 °C to +55 °C (-22 °F to +131 °F) for continuous operation; -34 °C to +74 °C (-30 °F to +165 °F) according to NEMA TS 2-2003 (R2008), para 2.1.5.1 using fig. 2.1 test profile
Cold start temperature	-20 °C (-4 °F)
Storage temperature	-50 °C to +70 °C (-58 °F to +158 °F)
Operating humidity	5% to 93% relative humidity
Storage humidity	Up to 98% relative humidity
Impact protection	IK10
Water/dust protection	IP 66 and NEMA Type 4X (with appropriate installation standards)

Dimensions

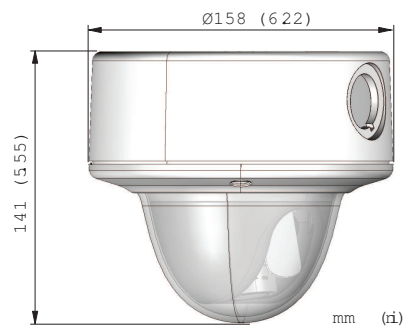
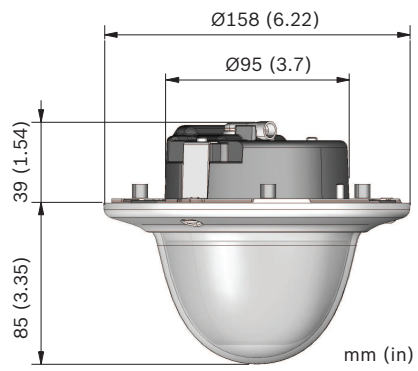



Bosch Security Systems B.V.

Torenallee 49

5617 BA Eindhoven

Netherlands

www.boschsecurity.com

© Bosch Security Systems B.V., 2019