



BEAMS & ENCLOSURES



ACTIVE INFRARED — PERIMETER DETECTION



Active Infrared

PHOTOELECTRIC BEAM DETECTORS



FIRST LINE OF DEFENSE

Security starts at the perimeter, or the 'A Zone', and OPTEX has built its reputation on a proven first line of defense. Our point-to-point photoelectric detection solutions give you full protection, creating a virtual trip wire at the perimeter. With multiple options and features for all threat levels, including battery-powered beams that require no trenching or wiring and tower enclosures for stacking and hiding beam height and location, OPTEX provides you with flexibility and choice based on your perimeter security needs.



PHOTOBAM PART NUMBER GUIDE



	Twin Beam	Single channel frequency	
S L - 2 0 0 T N R			
	Four channel frequency		Ready for wireless, battery-powered (Batteries included, accepts most manufacturers' wireless transmitters)
A X - 2 0 0 T F R			
	Quad Beam		
S L - 2 0 0 Q D P			
	Detection range in feet		
S L - 3 5 0 Q F R i			iSeries wireless, battery-powered (Inovonics EN1941 transmitter & batteries included)
	Detection range in feet		
S L - 6 5 0 Q D M			
Slimline design		Dual modulation	



FEATURES & VALUE

QUICK FEATURES GUIDE

Beam detection range shouldn't be the only feature you look at when selecting an OPTEX photobeam. Review the additional features below to find the right detector for your photobeam application.

“Beam alignment over long distances is troublesome.”

Solution: Sniper Viewfinder & BAU-4 Auto Alignment Unit

The **Sniper viewfinder** includes x2 magnification over conventional photobeam models. This allows for high visibility during the alignment process, even over long distances. The optional **BAU-4** Auto Beam Alignment Unit automatically and accurately adjusts the optical access to peak performance, allowing one technician the ability to align long distances beams without additional help.

For All SL Models

“I want to stack my photobeams for added protection.”

Solution: Four Channel Selectable Beam Frequencies

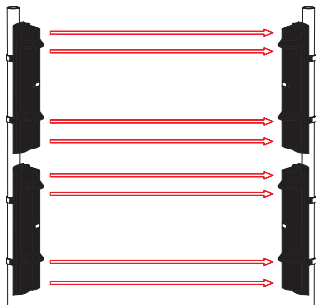

Require extra protection at the perimeter? Choose a photobeam detector that has four channel selectable frequency and stack two of them on a pole or better yet, in an AX-TW200 Beam Enclosure.

AX-100TF, AX-200TF, AX-100TFR, AX-200TFR, AX-100TFRI, AX-200TFRI, SL-350QFR, SL-350QFRI, SL-200QDP, SL-350QDP, SL-650QDP, SL-200QDM, SL-350QDM, SL-650QDM

“Getting power to perimeter is too expensive.”

Solution: Battery-Operated Models

To combat costly trenching and labor, or in situations where power is not available, choose one of OPTEX's wireless ready, battery operated models. Mount them in the AX-TW200 beam tower for a completely wireless and secure perimeter.

AX-100TFR, AX-200TFR, AX-100TFRI, AX-200TFRI, SL-350QFR, SL-350QFRI

“Fog, snow, & heavy rain can be an issue at my job site.”

Solution 1 : D.Q. Output (Environmental Disqualification)

D.Q. output will send a trouble signal when the beam strength is below acceptable levels, for more than 20-40 seconds, due to fog, snow or heavy rain.

AX-100TF, AX-200TF, AX-100TFR, AX-200TFR, AX-100TFRI, AX-200TFRI, SL-350QFR, SL-350QFRI, SL-350QDP, SL-650QDP, SL-350QDM, SL-650QDM

Solution 2 : A.T.C.P. (Automatic Transmit Power Control)

The A.T.C.P. feature automatically controls, adjusts and optimizes the power of the beam and maintains optimal performance. It decreases false and missed alarms caused by fog, frost, cross talk and signal saturation.

SL-350QDM

Hardwired Beam Considerations

Keeping these tips in mind will greatly reduce false and missed alarms caused by improper installation.

Distance

The longer the distance, the bigger the voltage drop. Drops in voltage can lead to missed and false alarms. For longer runs, use thicker gauge wire. (Max 18 gauge)

Power Supply

When selecting your photobeam's power supply, make sure to choose one with the correct Amps to cover the beam's current consumption.

Wiring

Choose the correct wiring conductor based on the outputs you want monitored. (Tamper, Alarm, D.Q. Circuit, Power; varies by model)

Zoning

Although photobeams can be installed in series, home runs are always recommended. This allows for easier troubleshooting and zones to be identified when an alarm occurs.

Battery-Powered Value

Cost

In the majority of cases, applications such as utility substations and large parking lots can be too expensive or labor intensive to trench.



Power

Battery-Powered beams can be installed in areas where power is not readily available, such as roof tops or remote locations.

Installation Downtime

Because of the significant drop in installation time and the fact that no trenching is required, end-users are less inconvenienced. Businesses and residents can operate as usual during the install.

Flexible

In environments where storage conditions may change, such as construction sites and storage facilities, battery-powered beam options allow the detection area to move accordingly with minimal effort.



Upgrade

Battery-powered beam options can easily be added on to existing security, video or access systems.

PHOTOELECTRIC BEAM DETECTORS

PROFESSIONAL MODEL SL-200QDM / 350QDM / 650QDM



- High power quad beam
- Double modulation
- Beam power control selector
- Automatic transmit power control
- Integrated alignment status comm
- Upper/lower beam selection button
- Beam power control selector

Model	SL-200QDM	SL-350QDM	SL-650QDM
Detection range	60m/200ft.	100m/350ft.	200m/650ft.
Beam frequencies	4ch selectable		
Current consumption	Normal 26mA / Max. 40mA		30mA / 43mA
Operating temperature	-13°F to 140°F (-25°C to +60°C) -30°F(-35°C) w/ HU-3 Heater		
Water protection	IP65		
Dimensions H x W x D	17.6 x 3.1 x 3.8 in (448 x 79 x 96 mm)		
Weight	88.2oz (2500g)		

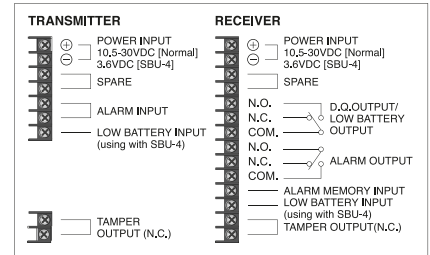

ADVANCED LEVEL SL-200QDP / 350QDP / 650QDP



- High power quad beam
- Double modulation
- Upper/lower beam selection button
- Beam power control selector

Model	SL-200QDP	SL-350QDP	SL-650QDP
Detection range	60m/200ft.	100m/350ft.	200m/650ft.
Beam frequencies	4ch selectable		
Current consumption	Normal 17mA / Max. 24mA	22mA / 33mA	
Operating temperature	-13°F to 140°F (-25°C to +60°C) -30°F(-35°C) w/ HU-3 Heater		
Water protection	IP65		
Dimensions H x W x D	17.6 x 3.1 x 3.8 in (448 x 79 x 96 mm)		
Weight	84.6oz (2400g)		

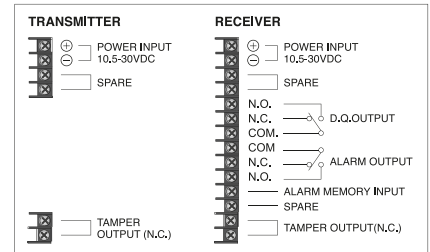

STANDARD MODEL SL-200QN / 350QN / 650QN



- High power quad beam
- Smart design — slim body & vivid interior color

Model	SL-200QN	SL-350QN	SL-650QN
Detection range	60m/200ft.	100m/350ft.	200m/650ft.
Beam frequencies	-		
Current consumption	38mA	39mA	40mA
Operating temperature	-13°F to 140°F (-25°C to +60°C) -30°F(-35°C) w/ HU-3 Heater		
Water protection	IP65		
Dimensions H x W x D	448 (17.6) x 79 (3.1) x 96 (3.8) mm (inch)		
Weight	84.6oz (2400g)		

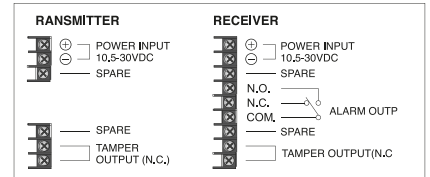

PROFESSIONAL MODEL ADVANCED MODEL SL-350QFRI & SL-350QFR

powered by **inovonics**



- Long distance 350ft (100m)
- Long battery life — 4 to 8 years
- Spacious back box for wireless transmitter
- Inovonics EN1941 included on SL-350QFRI model

Model	SL-350QFRI	SL-350QFR
Detection range	100m/350ft.	100m/350ft.
Beam frequencies	4ch selectable	
Power source	3.6 V, 13.0Ah LSH20 lithium batteries manufactured by SAFT Operating range: 3.2 V - 4.0 V Lithium batteries Transmitter: 2 or 4 units; Receiver: 2 or 4 units (A total of 4 batteries are included)	
Wireless Transmitter	Inovonics EN1941 Included	Not Included
Current consumption	745µA	
Operating temperature	-4°F to 140°F (-20°C to +60°C)	
Water protection	IP65	
Dimensions H x W x D	17.9 x 3.3 x 5.4 in (452 x 83 x 138 mm)	
Weight	116.4oz (3300g)	

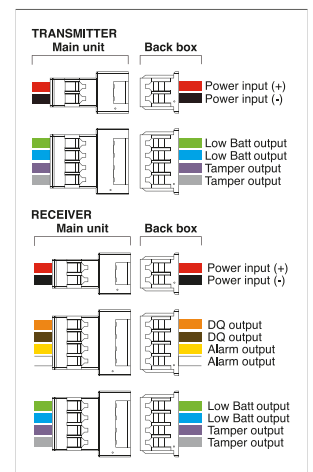

*Transmitters shown not included
*2 batteries per side included
*2 additional batteries per side can be added

SL SERIES FEATURES

High Immunity Against False Positives & Missed Alarms

Sniper Viewfinder™

X2 Magnification Lens

The new telescope lens has a high level of visibility for optical alignment work. Even over long distances, a perfect installation and stable performance can be achieved in a short period.



A.T.P.C. – Automatic Transmit Power Control (SL-QDM only)

Automatically controls, adjusts and optimizes the power of the beam and maintains optimal performance. It decreases false and missed alarms caused by fog, frost, cross talk, and signal saturation.

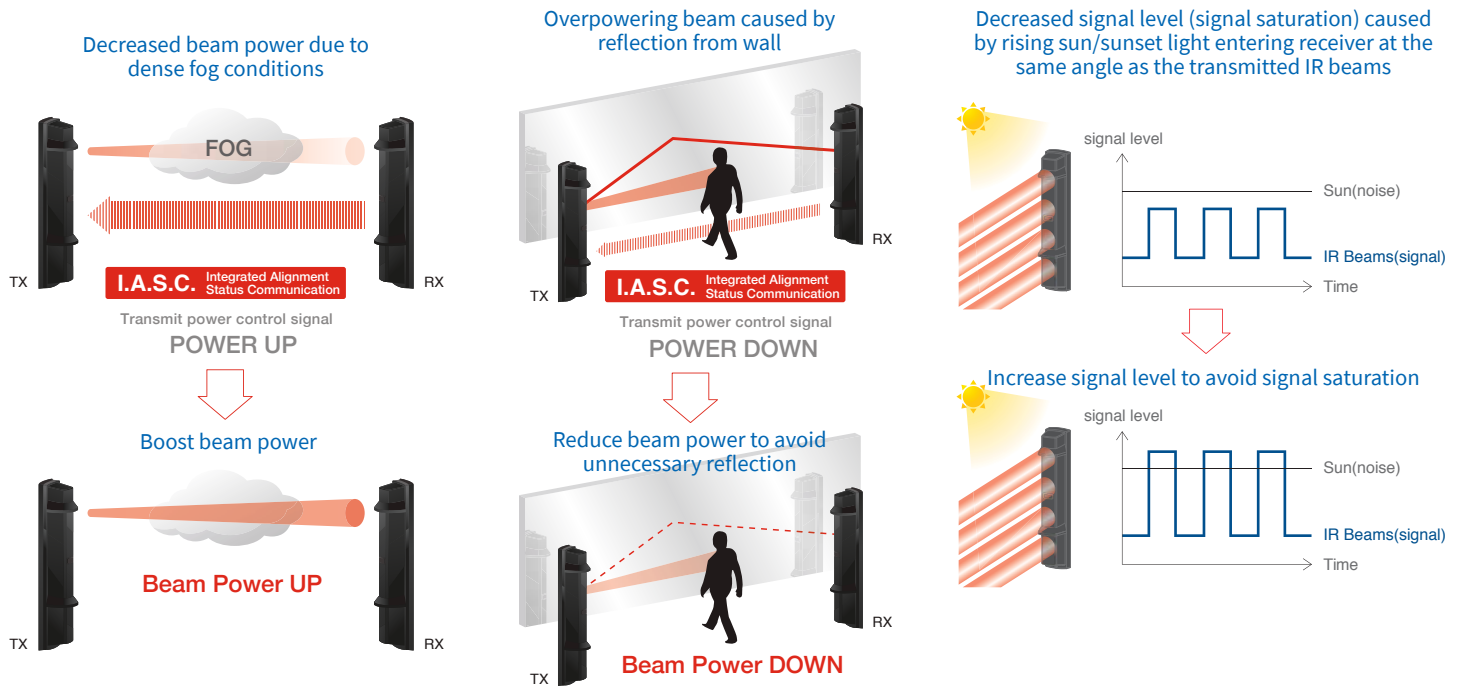

Sunshine Protection Technology (SL-QDM & QDP only)

The sunshine protection technology has a triple layer construction to give better performance against external light sources, such as from the sun, fluorescent lighting, and mercury-vapor lamps.

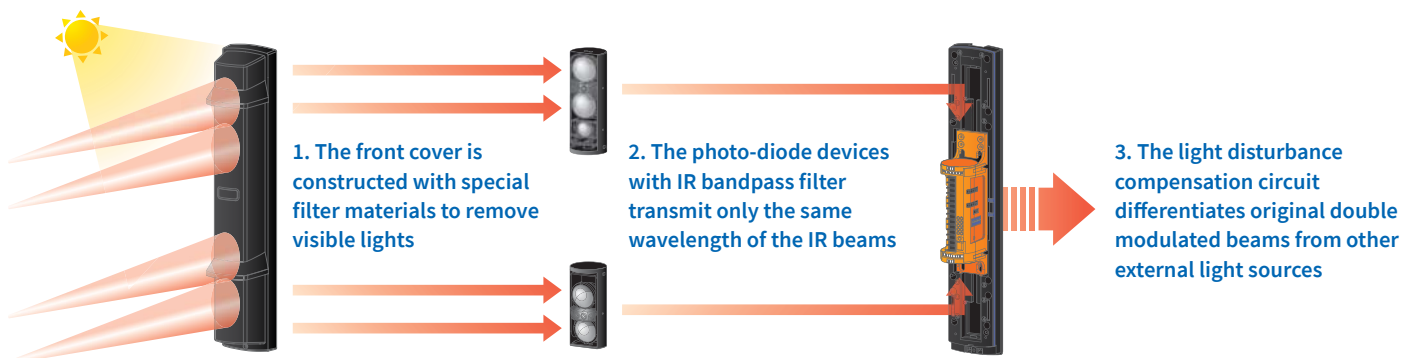

Double-Sided & Single-Sided BEAM ENCLOSURES

The TW-Series beam enclosures are suited for all OPTEX AX & SL Series wired, IP, and wireless battery-powered infrared beams models

Concealing active infrared beams in enclosures increases the security and flexibility of perimeter protection systems

OPTEX Dual & Quad IR beams can be mounted directly on walls or poles, however by installing them in enclosures, it makes them less obvious. The number and height of the fitted beams becomes unknown to the potential intruders, enhancing the security level.

- Free standing AX-TW models provide 360° unobstructed view for the beams, enabling back to back installation to cover a whole perimeter.
- Free-standing AX-TWS models provide 180° view enabling side detection for sites where wall mount is not a possible or practical option.
- Wall-mounted AX-TWM models feature 180° view and flush mount.
- 3'3" / 6'6" height options available.
- Durable construction with extruded and anodized aluminum frame and acrylic materials.
- Beams can be mounted at any height and direction in the tower.
- Additional housing and fixings for lighting or fixed cameras available as options.
- Anti-tamper and beam mounting plates included.
- Suitable for all wired, IP, and wireless OPTEX AX & SL (Smart Line) models. (Consult with us for the list of accessories needed)
- Enclosure assembly included at no charge when site plan is provided.



BUILD & CUSTOMIZE

STEP 1

Select Your Beams

Select beams by distance and features. All OPTEX beams can be mounted in the AX-TW enclosures. Beam models are based on detection distance for outdoor ratings (indoors can be doubled). Do you need adjustable frequencies? Double stacked or single?

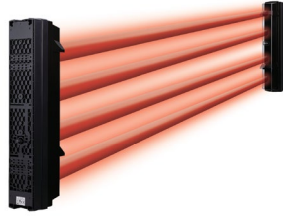

STEP 2

Choosing Beam Mounting Enclosure

OPTEX offers 2 enclosure options for mounting beams: 1) Double-sided, for multiple beginning/ending points or long distances, and 2) Single-sided, for point-to-point applications. Once you've decided on the teams, select the option that best fits your application.



STEP 3

Select Enclosure Height

OPTEX offers 2 enclosure options for mounting beams: 1) Double-sided, for multiple beginning/ending points or long distances, and 2) Single-sided, for point-to-point applications. Once you've decided on the teams, select the option that best fits your application.

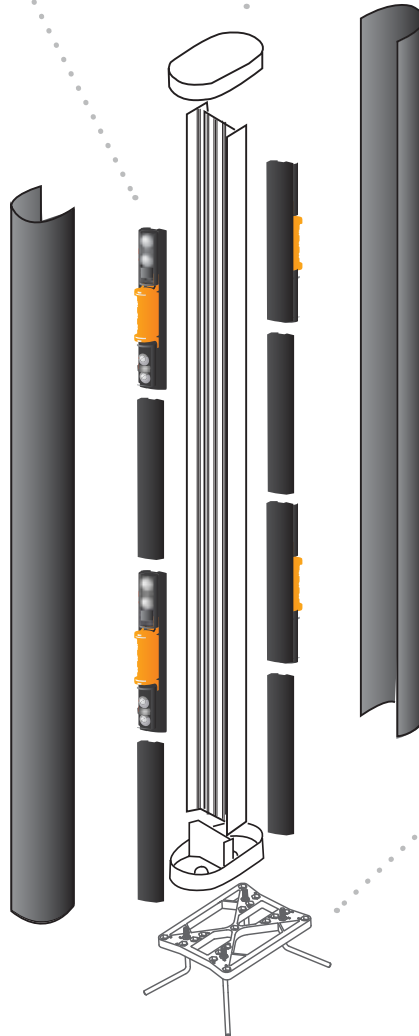

STEP 4

Choose Accessories

Depending on the environmental conditions, applications and security level, OPTEX offers accessories to enhance your perimeter system.



Mounting brackets set in concrete/asphalt, heaters, and anti-climb tampers are all examples of accessories for your beam enclosure.



STEP 5

Pre-Assembly

When a site plan is provided, OPTEX technicians will pre-assemble our photoelectric beams and tower enclosures to match your customers' specifications. As long as a site plan is provided, this service will not be charged.



BATTERY-POWERED, WIRELESS & IP SOLUTIONS

Battery-Powered, Wireless Solution

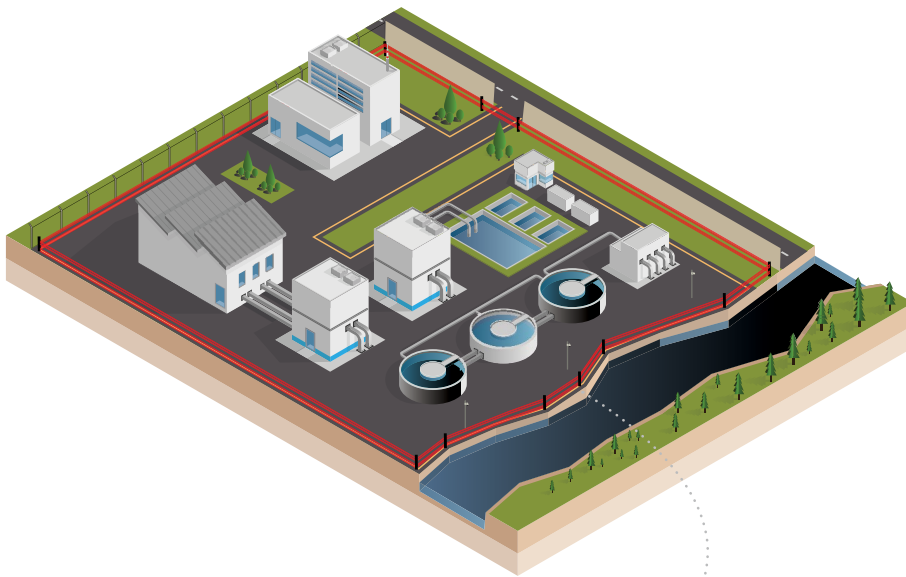

Save Time & Money

From rooftop HVAC protection to electrical substations, the wireless-ready, iSeries photobeams, and enclosures from OPTeX can offer you a battery powered, wireless solution for all your security needs. While the wireless-ready versions are shipped with an empty backbox that will accept any manufacturer's wireless transmitter, the iSeries come with Inovonics EN1941 wireless transmitters pre-installed, allowing even more time saved while on the job site. The EN1941 monitors the DQ circuit, tamper and primary alarm, while an included BCU-4 module monitors for low battery. A total of four lithium batteries are also included to power the beams.

Value of a Wireless-Ready Battery-Powered System

- Easy solution to sites where trenching is too expensive or labor intensive.
- Can be installed in areas where power is not readily available.
- No downtime to end-user. Businesses & residents can operate as usual during install.
- Allows for a flexible solution in changing site environments, such as construction sites.
- Can easily be added on to support existing video or access systems.



Inovonics®
EN5040T Repeater

*If repeater is mounted outdoors, ACC650 enclosure is required

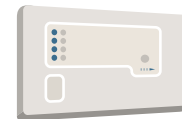

Inovonics®
EN4232MR Receiver

EN7290 Receiver/Interface for VISTA 128/250

Any Intrusion or Access Panel with Hardwired Inputs



Any PC Application

IP Solution

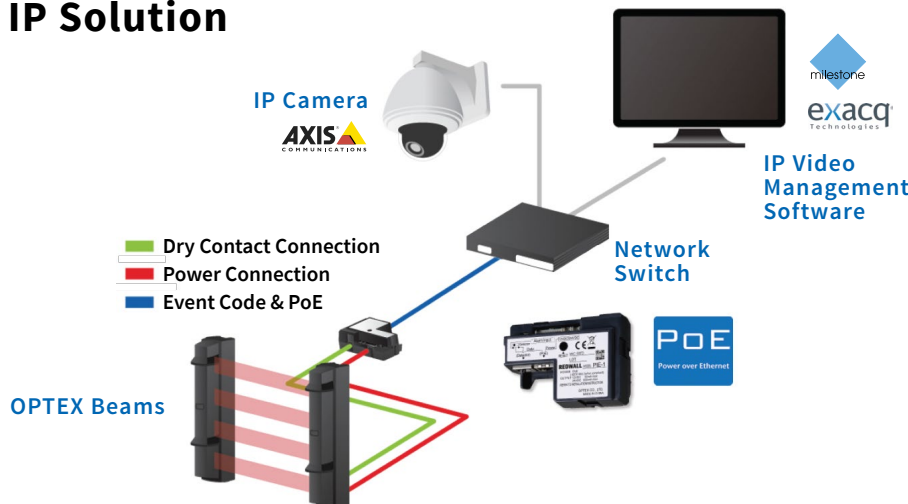

Sensing Solutions For IP Systems

When PIE-1 IP encoders are combined with OPTeX beams & enclosures, a complete IP powered detection solution is achieved. You can now connect to all leading VMS platforms to control IP cameras, and PIE-1 is compatible with Power over Ethernet (PoE), making it possible to supply power using a PoE hub or switch. With the PoE connection, alarm signal information can be exchanged via IP protocol. In addition, only one LAN cable is needed to connect PIE-1 to a PoE hub or switch, reducing installation time & cost.

BEAM ENCLOSURE PART NUMBERS

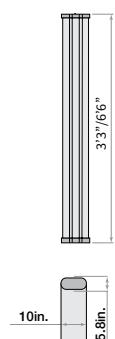
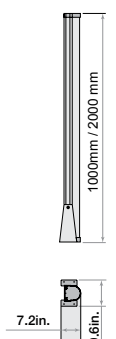
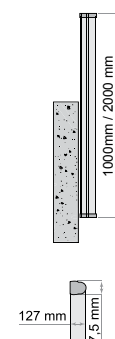
Beam Enclosure Cover	TW 360° Free-Standing Beam Enclosures	STW 180° Free-Standing Beam Enclosures	STWM 180° Wall-Standing Beam Enclosures
			
AX-TW(S)(M)	AX-TW	AX-TWS	AX-TWM
Ground Mounting, 360°	Ground Mounting, 180°	Wall Mounting, 180° Flush Mount	
AX-TW100 3'3" 360° Beam Tower Floor	AX-TW100S 3'3" 180° Beam Tower Floor	AX-TW100M 3'3" 180° Wall Mount Beam Tower	
AX-TW200 6'6" 360° Beam Tower Floor (standard height)	AX-TW200S 6'6" 180° Beam Tower Floor	AX-TW200M 6'6" 180° Wall Mount Beam Tower	

Exterior Installation Mounting for Enclosures

When using a free-standing tower, the AX-TWEB allows for secure concrete mounting, even in uneven soil and the harshest of environments.

Dig an 18" x 18" x 18" (minimum) hole. Add rebar or support if needed and pour concrete (for TWEB bracket) or asphalt (for TWEB-A bracket). Insert bracket and cable access conduit while concrete/asphalt is still wet.

TWEB Pictured

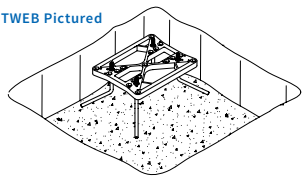

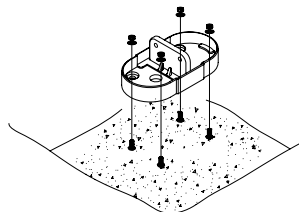

With included red head bolts, secure enclosure base to bracket bold heads (Bolts can also be added to existing concrete/asphalt)

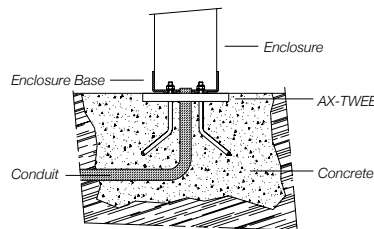

With included red head bolts, secure enclosure base to bracket bold heads (Bolts can also be added to existing concrete/asphalt)



Common Accessories

 AX-TWLUXE Tower head extension for lighting (12V light bulb not included)	 AX-TWEB Concrete support bracket for free-standing enclosures on pads	 AX-TWH24V 12V or 24V, 250mA, non-polarity heater & thermostat	 AX-TWSSL Bracket for SL & AX-TFR series (set)	 AX-TWCAM CCTV extension head for enclosure (Camera not included)
 AX-TWAA Anti-climb top tamper	 AX-TWEB-A Asphalt support bracket for free-standing enclosures on pads	 AX-TWCAB Guy wires for photobeam enclosures in extreme wind conditions	 AX-TWSM Pole/wall mount L bracket for AX-TW50, 100, 200, & 300	 BAU-4 Automatic beam-alignment tool (only compatible with SL series)

TOTAL SECURITY SOLUTIONS

HIGH SECURITY LASER DETECTION

Use laser technology from OPTEX to create a horizontal plane or vertical wall with four outputs for remote video applications and 8 independently adjustable detection areas. The **REDSAN RLS-3060SH** is the ideal detector for controlling network cameras and can be integrated with leading VMS platforms, access control systems and analog control panels.



RLS-3060SH



EN5040T Repeater
EN7290 Receiver
ACC650 Enclosure
(Outdoor use)

AX-TW200
6'6" double sided
Free-standing beam
enclosure

AX-TW200
6'6" double sided
Free-standing beam
enclosure

SL-350QFRi
iSeries battery-powered wireless photobeams

SL-350QFRi
iSeries battery-powered wireless photobeams

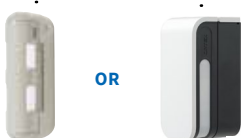
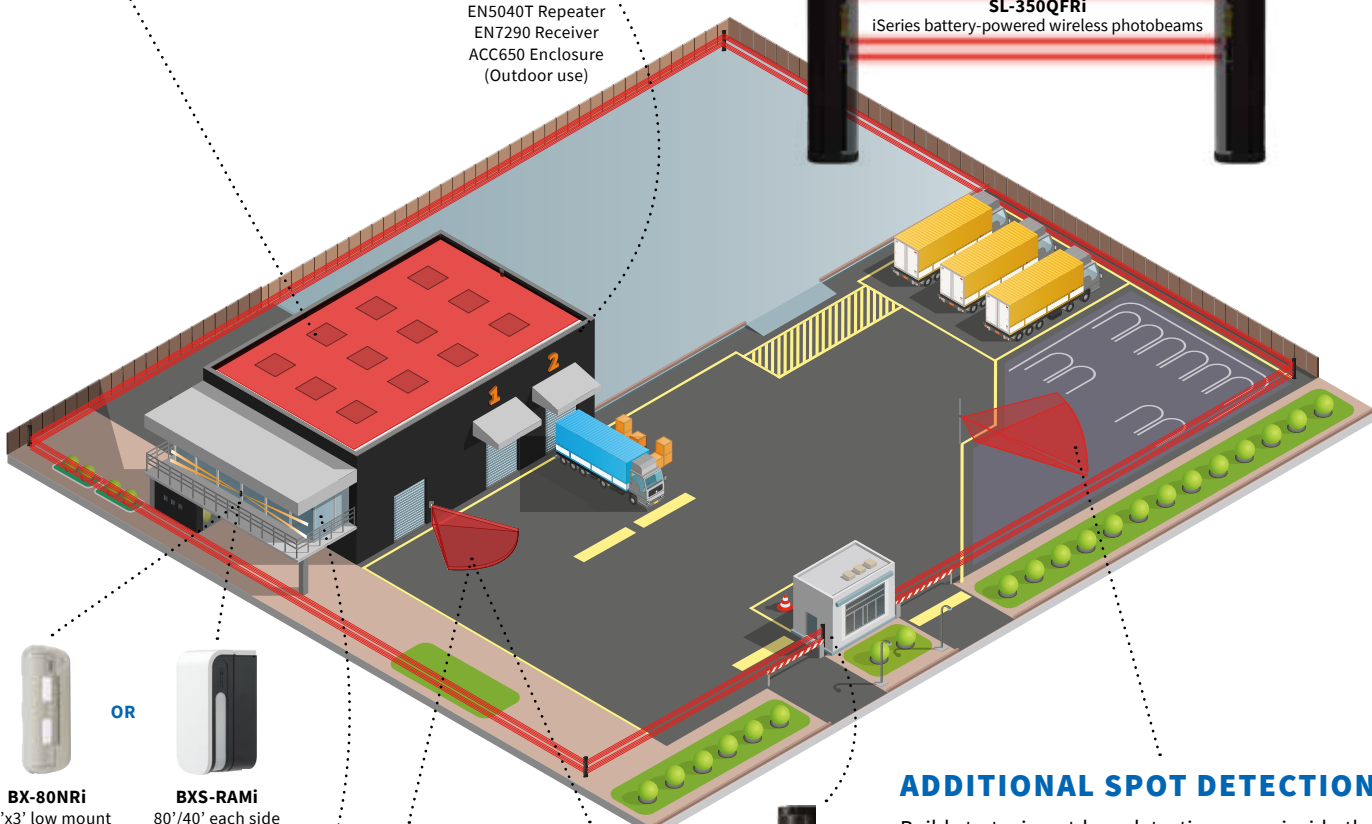

OR

BX-80NRi
80'x3' low mount
Battery-powered
Outdoor dual PIR

BXS-RAMi
80'/40' each side
Battery-powered
Anti-masking
Outdoor quad PIR

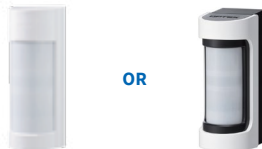

OR

VXI-RDMi
40'x40' low mount
Battery-powered
Outdoor dual tech

VXI-RAMi/RDAMi
40', 90' low mount
Battery-powered
Anti-masking
Outdoor PIR/dual tech



inovonics
EN4232MR Receiver
EN7290 Receiver

ADDITIONAL SPOT DETECTION

Build strategic outdoor detection areas inside the perimeter and throughout the property, without running wires for power or signal. In addition, OPTEX passive infrared and dual technology detectors can trigger cameras, lights, or be used to notify the authorities when motion is detected.

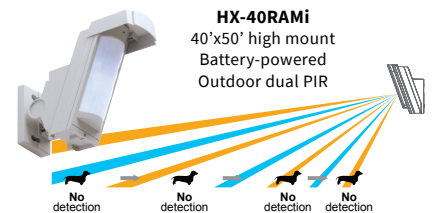

HX-40RAMi
40'x50' high mount
Battery-powered
Outdoor dual PIR



AX-TW200M

6'6" single sided, wall mount beam enclosure

CONTACT US

From residential to critical infrastructure, OPTEX has the right solution for any application & environment.

With indoor and outdoor detection options for every threat level, OPTEX provides you with flexibility and choice based on your perimeter security needs. Since its founding over 30 years ago, OPTEX has established a worldwide reputation for quality, innovation, and technical excellence. Our products will always represent an investment in performance, and long term satisfaction.

NOTES



800.966.7839
sales@optexamerica.com
www.optexamerica.com



facebook.com/
optexamerica





@optexamerica



linkedin.com/
company/optex

ENCLOSURES

Hybrid, Battery-Powered, & Wireless Options

	Standard Models			Advanced Models			Professional Models			
	SL-200QN	SL-350QN	SL-650QN	SL-200QDP	SL-350QDP	SL-650QDP	SL-200QDM	SL-350QDM	SL-650QDM	
<p>6.6" TOWERS AX-TW200 AX-TW200S AX-TW200M</p> 	SL-100TNR Hybrid Powered	SL-100TNR1 Includes Intronics EN1941 transmitter and batteries	SL-200TNR Hybrid Powered	SL-200TNR1 Includes Intronics EN1941 transmitter and batteries	AX-100TFR Includes batteries	AX-100TFR1 Includes Intronics EN1941 transmitter and batteries	AX-200TFR Includes batteries	AX-200TFR1 Includes Intronics EN1941 transmitter and batteries	SL-350QFR Includes batteries	SL-350QFR1 Includes Intronics EN1941 transmitter and batteries
<p>3.3" TOWERS AX-TM100 AX-TM100S AX-TM100M</p> 	<p>USE THIS BEAM IF One beam unit is close to main power source but other beam unit needs to be wireless. Power is not available. Shorter distance is required. DQ Circuit is needed.</p>									
<p>Outdoor detection range</p>	100ft		200ft		100ft		200ft		350ft	
<p>Indoor detection range</p>	200ft		400ft		200ft		400ft		700ft	
<p>Beam</p>	Twin		Twin		Twin		Twin		Quad	
<p>Beam blocking ratio</p>	99%		99%		99%		99%		99%	
<p>4ch. selectable freq.</p>	3		3		3		3		3	
<p>Alignment angle</p>	+/- 90° Horiz., +/- 5° Vert		+/- 90° Horiz., +/- 5° Vert		+/- 90° Horiz., +/- 5° Vert		+/- 90° Horiz., +/- 5° Vert		+/- 90° Horiz., +/- 10° Vert	
<p>LED indicator</p>	4step LED indicator		4step LED indicator		4step LED indicator		4step LED indicator		5 Step with sound assist	
<p>Monitor jack for align.</p>	3		3		3		3		3	
<p>Beam alignment method</p>	Viewfinder		Viewfinder		Viewfinder		Viewfinder		Sniper viewfinder™ (Included) / BAU-4 Beam Alignment Unit (Optional)	
<p>Automatic gain control</p>	No		No		No		No		3	
<p>Lightning protection</p>	Yes, Wirefree operation		Yes, Wirefree operation		Yes, Wirefree operation		Yes, Wirefree operation		3over14kV	
<p>Environment DQ</p>	3		3		3		3		3	
<p>Power supply</p>	3.6V 13.0Ah LSH20 lithium batteries (For Hybrid: 2 included for Transmitter Unit)		3.6V 13.0Ah LSH20 lithium batteries (4 included)		3.6V 13.0Ah LSH20 lithium batteries (4 included)		3.6V 13.0Ah LSH20 lithium batteries (4 included)		10.5 - 30V DC	
<p>Current draw/ (Peak)</p>	500µA	Form C	600µA	Form C	75µA	Form C	38mA max. 39mA max. 40mA max.	24mA max. Form C relay: 30VDC, 0.2 A	40mA max. Form C relay: 30 VDC, 0.2 A	43mA max.
<p>Alarm output</p>	3		3		3		3		3	
<p>Tamper</p>	3		3		3		3		3	
<p>Alarm memory</p>	—		—		—		—		—	
<p>Anti-frost design</p>	3		3		3		3		3	
<p>Optional heating unit</p>	HU-3, Requires local power		HU-3, Requires local power		HU-3, Requires local power		HU-3, Requires local power		HU-3	
<p>International protection</p>	IP65		IP65		IP65		IP65		IP65	
<p>Operation temperature</p>	-4° to 140°F (-20 to 60 °C)		-4° to 140°F (-20 to 60 °C)		-4° to 140°F (-20 to 60 °C)		-31° to 140°F (-35 to 60 °C)		-31° to 140°F (-35 to 60 °C)	
<p>Environmental humidity</p>	95% max.		95% max.		95% max.		95% max.		95% max.	
<p>Dimensions (HxWxD in)</p>	11.6 x 2.7 x 4.6		8.5 x 3.5 x 6.4		17.9 x 3.3 x 5.4		17.6 x 3.1 x 3.8		17.6 x 3.1 x 3.8	

PIE-1
POE IP Encoder



Allows beams to connect / Integrate with all leading VMS platforms to control IP cameras (should be ordered in pairs)

ABC-4
Anti-Bird Cap



Prevents birds and small animals from sitting on detector. Also protects the front of detector from excessive rain and snow.

HU-3
Heating Unit



Heating Unit for Hardwired SL Models and AX-TN, AX-TF Models.

BC-4
Back cover



Conceals the back side of a pole mounted SL Series detector.

PSC-4
Pole side Cover



Conceals the gap between two pole mounted, back to back SL Series detectors.

GBR-4
Conduit Bracket



Required to run conduit to the SL Series detectors.