

INSTALLATION INSTRUCTIONS

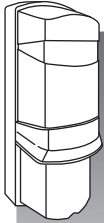

PHOTOELECTRIC DETECTOR

AX-70TN, AX-130TN, AX-200TN

AX-100TF, AX-200TF

Model	Detection range	Feature
AX-70TN	20 m / 70 ft.	Standard model with detection range
AX-130TN	40 m / 130 ft.	
AX-200TN	60 m / 200 ft.	
AX-100TF	30 m / 100 ft.	4 selectable beam frequencies
AX-200TF	60 m / 200 ft.	

FEATURES

< AX-70/130/200TN, AX-100/200TF >

- High-performance waterproof structure
- Horizontal alignment dial for user-friendliness
- Adjustable beam interruption period
- Tamper function
- Optional Accessories : Heating unit (HU-3), Back cover (BC-3), Pole side cover (PSC-3)
- UL Listed

< AX-100/200TF ONLY >

- 4 selectable beam frequencies
- LED indicator for fine beam alignment level
- D.Q. circuit (Environmental disqualification)
- Alarm memory



CONTENTS

1 INTRODUCTION	6 WALK TEST	9
1-1 BEFORE YOUR OPERATION	2	
1-2 PRECAUTIONS	3	
2 PARTS IDENTIFICATION	7 SPECIAL FUNCTION < AX-100/200TF ONLY >	9
3 INSTALLATION	7-1 ENVIRONMENTAL DISQUALIFICATION	9
3-1 NOTE	7-2 ALARM MEMORY	9
3-2 INSTALLATION METHOD	8 OPTIONAL ACCESSORIES	
4 WIRE CONNECTION	8-1 HEATING UNIT : HU-3	10
5 ALIGNMENT	8-2 BACK COVER : BC-3	11
5-1 OPTICAL ALIGNMENT	8-3 POLE SIDE COVER : PSC-3	11
5-2 BEAM INTERRUPTION TIME	9 TROUBLESHOOTING	12
5-3 SELECTABLE BEAM FREQUENCIES	10 SPECIFICATIONS	
< AX-100/200TF ONLY >	10-1 SPECIFICATIONS	13
	10-2 DIMENSIONS & OPTION	14

1 INTRODUCTION

1-1 BEFORE YOUR OPERATION

- Read this instruction carefully prior to installation.
- After reading, store this instruction carefully in an easily accessible place for reference.
- This instruction uses the following warning indications for correct use of the product, harm to you or other people and damage to your assets, which are described below. Be sure to understand the description before reading the rest of this instruction.



 Warning	Failure to follow the instructions provided with this indication and improper handling may cause death or serious injury.
 Caution	Failure to follow the instructions provided with this indication and improper handling may cause injury and/or property damage.

 This symbol indicates prohibition. The specific prohibited action is provided in and/or around the figure.

 This symbol requires an action or gives an instruction.

Warning

Do not use the product for purposes other than the detection of moving objects such as people and vehicles. Do not use the product to activate a shutter, etc., which may cause an accident. 

Do not touch the unit base or power terminals of the product with a wet hand (do not touch when the product is wet with rain, etc.). It may cause electric shock.  

Never attempt to disassemble or repair the product. It may cause fire or damage to the devices. 

Do not exceed the voltage or current rating specified for any of the terminals during installation, doing so may cause fire or damage to the devices. 

Caution

Do not pour water over the product with a bucket, hose, etc. The water may enter, which may cause damage to the devices. 

Clean and check the product periodically for safe use. If any problem is found, do not attempt to use the product as it is and have the product repaired by a professional engineer or electrician. 

1-2 PRECAUTIONS

Mount unit only on a solid surface.

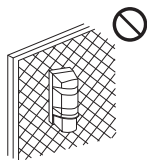

Do not install the unit on unsteady surfaces.

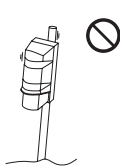

Do not install the unit where objects moved by the wind such as plants and laundry, which may block the beam.

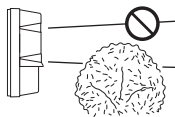

Prevent direct sunlight from entering into internal receiver.

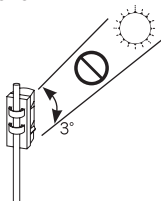

A different type of beam should not reach the receiver.

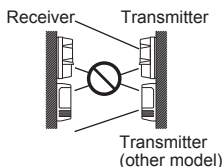

Avoid aerial wiring.

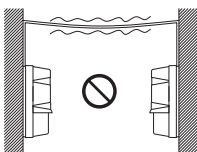

Mount the units more than 1 m away from the wall or fence.

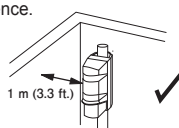

⊘ This symbol indicates prohibition.

✓ This symbol indicates recommendation.

2 PARTS IDENTIFICATION

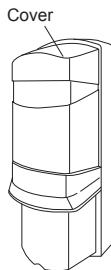

Cover

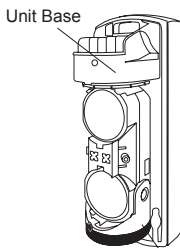

Unit Base

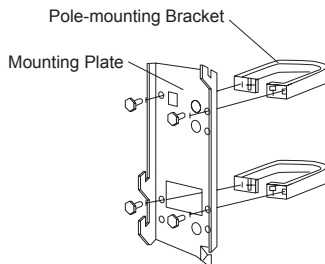

Pole-mounting Bracket

Mounting Plate

Optical Unit

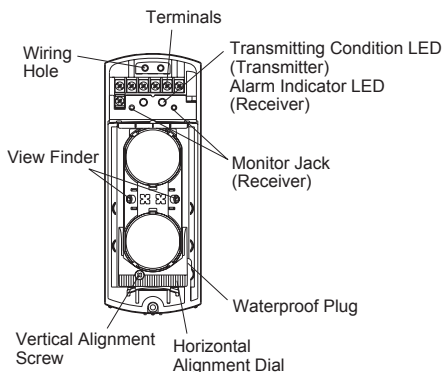

Terminals

Wiring Hole

Transmitting Condition LED (Transmitter)
Alarm Indicator LED (Receiver)

View Finder

Monitor Jack (Receiver)

Waterproof Plug

Vertical Alignment Screw

Horizontal Alignment Dial

Alarm Memory (Receiver)
(See "7-2 ALARM MEMORY < AX-100/200TF ONLY >")

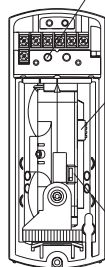

Selection Dip Switch
(See "4 WIRE CONNECTION", "5-2 BEAM INTERRUPTION TIME", and "7-2 ALARM MEMORY < AX-100/200TF ONLY >")

Selection Switch
(See "5-3 4 SELECTABLE BEAM FREQUENCIES < AX-100/200TF ONLY >")

3 INSTALLATION

3-1 NOTE

Detection range and installation

Distances between the Receiver and the Transmitter

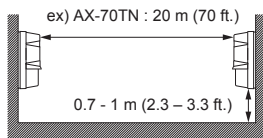

Alignment angle

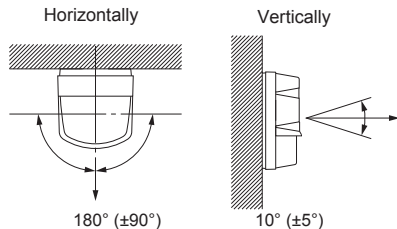

Pole mounting

Pole size should be $\phi 32 - 48$ mm (1 1/4" - 1 7/8") (Standard U.S. 1 1/4" or 1 1/2" pipe)

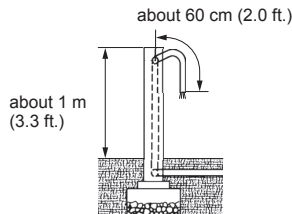

Non-recommended installation angle

In case to be installed in these angles as below, maximum detection range shall be half of the original detection range. (The attenuation of beam by the edge of the cover)

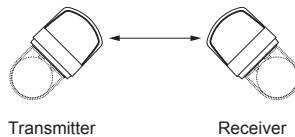

3-2 INSTALLATION METHOD

1 Detach the cover and the screw

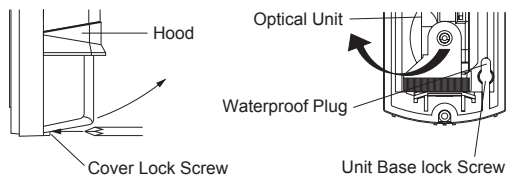

Note>>

When removing the cover, do not put your fingers on the hood, which may cause damage.

- 1) Loosen the cover lock screw to detach the cover.
- 2) Turn the optical unit and open the waterproof plug.
- 3) Loosen the unit base lock screw and slide the mounting plate downward to detach the unit base.

2 Fix the mounting plate

Wall mounting

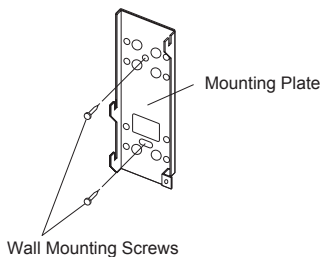

Pole mounting (1 plate)

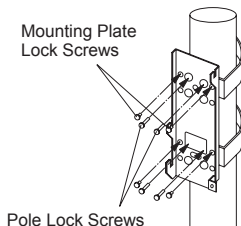

Pole mounting (2 plate)

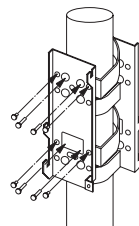

3 Wiring

Use wires in compliance with the following conditions:

- 1) Wire diameter: $\phi 4 - 7\text{mm}$
- 2) When using any other wires than the above, seal the wiring port with a waterproof agent (silicon, etc.) to prevent water from coming in through the gap.
- 3) Number of wires: 3 (max.)

3 wires can be accommodated in a unit.
Lead-in wire should be as below.

* Wiring hole 2 needs to be punched with a screw driver, etc.

** To have the wiring hole 3, wiring port needs to be cut with a cutter knife, etc. After inserting the wire, seal the wiring port with a waterproof material like silicon for leakage prevention.

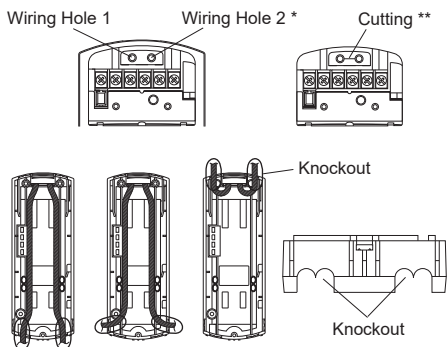
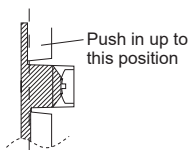
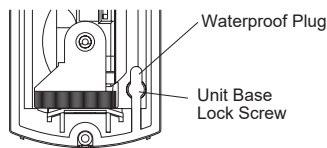

Figure 1 Figure 2 Figure 3

Wiring guide should be as above.
Knockout needs to be opened with a nipper, etc.

4 Mount the unit base



Side view of the waterproof plug

Connect the terminals with reference to "4. WIRE CONNECTION" and slide the unit base into the mounting plate from above, then fasten the unit base mounting screws to fix the unit base.

Then, push in the waterproof plug up to the broken line shown in the figure.

5 Alignment and walk test

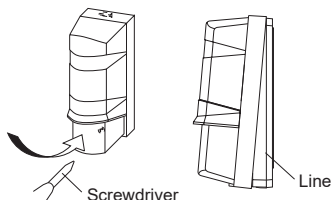
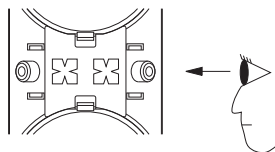

Align the optical axis to the maximum receiving level according to "5-1. OPTICAL ALIGNMENT". Then, check for the operation with reference to "6. WALK TEST".

Put the cover and tighten the cover lock screw.
Make sure that the cover edge has reached the line prepared on the side of the unit base (See the figure left)

4 WIRE CONNECTION

Connect respective wires to the terminals shown in the following figure.

-Terminal

[AX-70/130/200TN]

Note>>

Non-Voltage contact output
Resistive load only

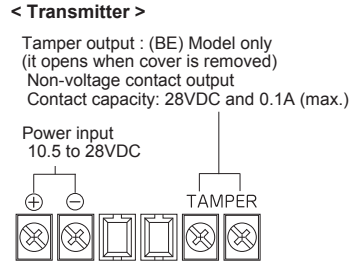
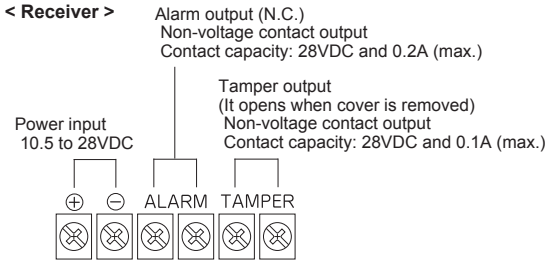

[AX-100/200TF]

Alarm output: (N.C./N.O.) switch (In case of using N.O., contact is not reversed when power supply is off.)

N.C. / N.O. selection Switch

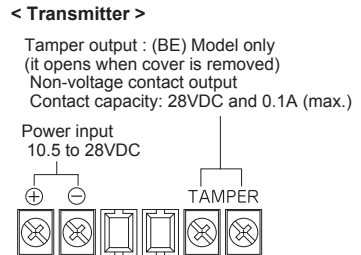
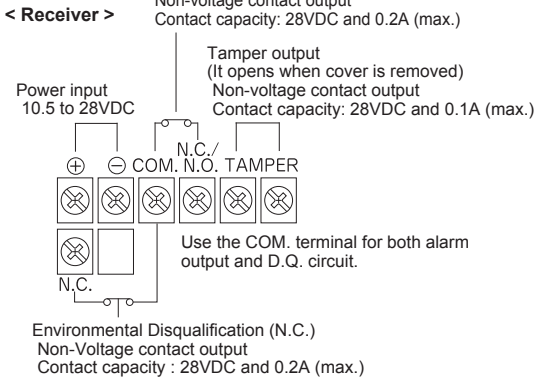

-Wiring distance between power supply and detector

- Ensure that the wiring distance from the power supply is within the range shown in the table on the below.
- When using two or more units on one wire, the maximum length is obtained by dividing the wire length listed below by the number of units used.

Wire size	Power supply voltage	
	12VDC	24 VDC
AWG22 (0.33mm ²)	500 m (1700 ft.)	2400 m (7800 ft.)
AWG20 (0.52mm ²)	700 m (2200 ft.)	3500 m(11400 ft.)
AWG18 (0.83mm ²)	1100 m (3600 ft.)	5500 m (18000 ft.)
AWG16 (1.31mm ²)	1700 m (5500 ft.)	8000 m (26200 ft.)

Warning

Do not exceed the voltage or current rating specified for any of the terminals during installation, doing so might cause fire or damage to the devices.



Note>>

For UL Listed applications, the units shall be connected to a UL Listed control unit or Listed Burglar Power Supply capable of providing a minimum of 4 hours standby power.

5 ALIGNMENT

5-1 OPTICAL ALIGNMENT

The optical alignment is an important adjustment to increase reliability. In accordance with the procedure indicated in the items 1. and 2. in this chapter, make sure to align the monitor jack that monitor output nothing to attain the maximum level.

1 Rough alignment by viewfinder

- While looking through the viewfinder, turn the dial to make alignment in such a way that the other detector is at the center of the sights.

< Horizontal alignment >

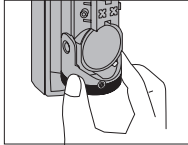

Turn the horizontal alignment dial by fingers to make alignment

< Vertical alignment >

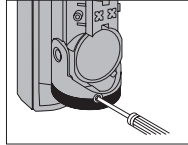

Turn the vertical alignment dial with a screwdriver to make alignment

- For Horizontal/Vertical alignment, refer to the following illustration.

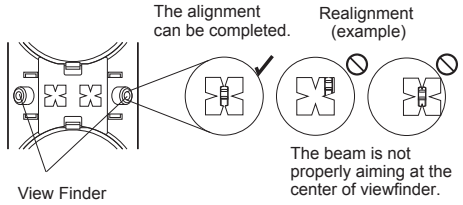

2 Checking of the illumination and Fine alignment

Checking of the illumination of the Alarm Indicator

- After the rough alignment using the viewfinder, check the light receiving status by the Alarm Indicator.

The relation between monitor output and receiving level of optical axis.

< Receiver >

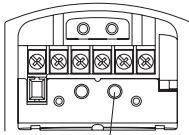

Alarm Indicator

AX-70/130/200TN	Alarm Indicator	Light interrupting ON (red)	Light receiving OFF			
	Monitor output	●	○			
			Realign Less than 2.2V	Fair 2.2V or more	Good 2.5V or more	Excellent 2.9V or more
AX-100/200TF	Alarm Indicator	Light interrupting ON (red)	fast flicker	slow flicker	Light receiving OFF	
	Monitor output	●	●	○	○	○
			Realign Less than 1.0V	Fair 1.0V or more	Good 2.0V or more	Excellent 2.5V or more

Fine adjustment with monitor jack

- After checking the receiving level of optical axis by using the alarm indicator, make sure to make fine alignment for both transmitter and receiver with voltmeter until it reaches maximum monitor output over "Good" level.

< Receiver >

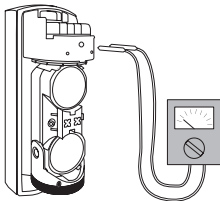

Set the voltmeter range to 5 to 10VDC and connect the voltmeter probes ⊕ and ⊖ to ⊕ and ⊖ of the monitor jack respectively.

< Receiver / Transmitter >

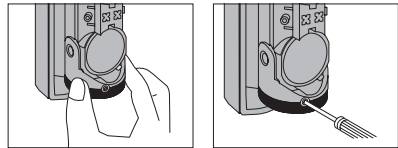

The horizontal / Vertical alignment.

Note>>

When making the adjustment by the monitor jack, be careful not to intercept the optical unit with your hand, the tester pin cord, etc.

5-2 BEAM INTERRUPTION TIME

Initial setting is at 50ms for normal work.

According to the speed of a supposed target you select one specific setting out of 4 steps.

Set the interruption time adjustment switches of the Receiver according to the speed of the human object to detect.

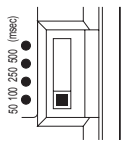

[AX-70/130/200TN]
Selection Switch

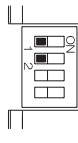

[AX-100/200TF]
Selection Dip Switch

Interruption time	Switches
50 ms	1:OFF, 2:OFF
100 ms	1:OFF, 2:ON
250 ms	1:ON, 2:OFF
500 ms	1:ON, 2:ON



50msec

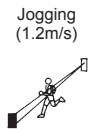

100msec

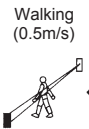

250msec



500msec

5-3 4 SELECTABLE BEAM FREQUENCIES < AX-100/200TF ONLY >

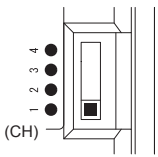

Selection Switch

The selectable beam frequencies can be used to avoid unwanted crosstalk that can occur when using multiple photo-beams for long distance or beam stacking applications.

- To select between 4 separate beam frequencies, use the switch provided.
- Make sure the receiver and transmitter that are facing each other are set to the same channel.
- More than double stacked application is not possible.

Note>>

Always switch the frequencies TWO channels apart when stacking units on top of one another (See following example).

The upper unit is set on channel 1 while the lower is on channel 3. channels 2 and 4 could have also been used.

<EXAMPLE>

1. Long distance protection

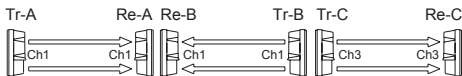

Keys>>

Tr-A= Transmitter "A"
Re-A = Receiver "A"

2. Double stacked long distance protection

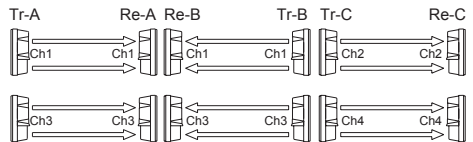

Note>>

More than double stacked application is not possible.

3. Perimeter protection

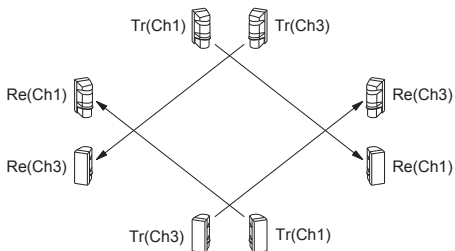

4. Double stacked long perimeter protection

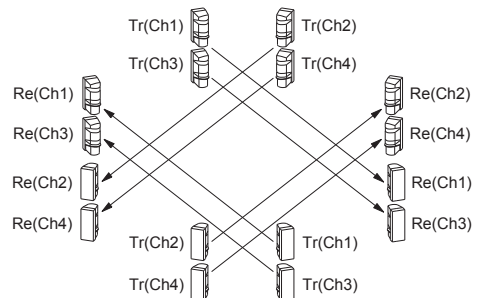

6 WALK TEST

Make sure to check for the operation after installation.

1 Checking by the Alarm Indicator

< Receiver >



Make sure that the Alarm Indicator is OFF. If it is illuminated even when the beams are not blocked, make optical alignment again.

2 Walk test

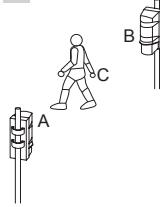

Be sure to conduct a walk test (to block the infrared beam) at the following three points:

- A. In front of the Transmitter
- B. In front of the Receiver
- C. At the middle point between the Transmitter and the Receiver

If there are reflective things such as a fence, stop at the position C, once and make sure that the detector operates correctly.

Note>>

If the Alarm Indicator is not turned on after beam interception, check for the operation with reference to "9. TROUBLE SHOOTING."

7 SPECIAL FUNCTION < AX-100/200TF ONLY >

7-1 ENVIRONMENTAL DISQUALIFICATION

D.Q. will send a trouble signal which indicates the adverse weather condition when the beam strength is being kept more than 40 seconds.

adverse weather level > the beam strength > alarm output level

< Operating time chart >

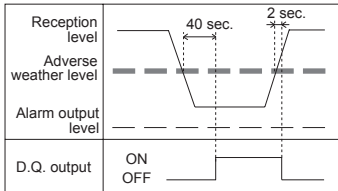

< Example >

[D.Q. + Alarm]

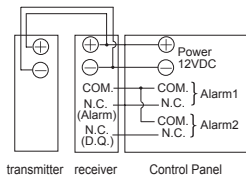

Use the COM. terminal for both alarm output and D.Q. circuit.

[Alarm Output Cancellation]

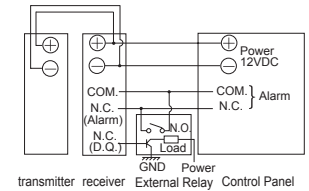

By using external relay (N.O.), alarm output can be cancelled while D.Q. send signal.

7-2 ALARM MEMORY

This function is used to indicate which detector was activated with alarm memory LED while several detectors are installed in one site.

For first 5 minutes after the alarm output, the alarm memory indicator do not light up. Then the alarm memory indicator keep lighting up for 55 minutes. 5 minutes. Alarm memory record is cleared after alarm memory indicator is turned off.

< Receiver >

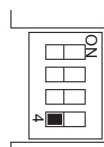

OFF ↔ ON
(Indicator ON) (Indicator OFF)
Selection Dip Switch

< Indicator >

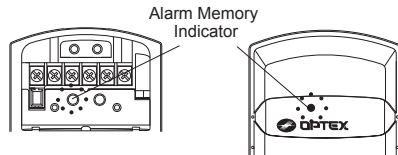

Through the cover

< Operating time chart >

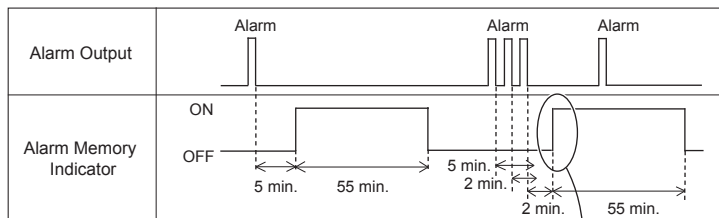

< Alarm Memory Indicator >

* Number of blinking N (times) tells how long it passed over after alarm output.
 "N" is added one time every 5 minutes.
 (N=1 ~ 11)

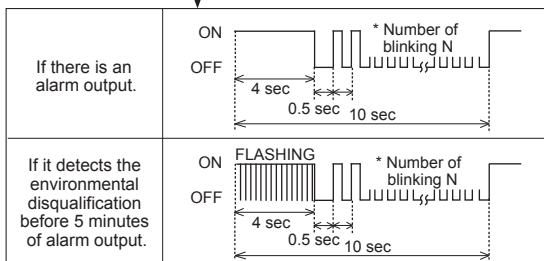

8 OPTIONAL ACCESSORIES

8-1 HEATING UNIT : HU-3

Power voltage of 24 VAC/DC is required to use the heating unit.

Note>>

In case the same power supply is used for the sensors, wiring distance is required according to the table shown in 4.

1 Cutout of the knockout

Cut off the shaded area.

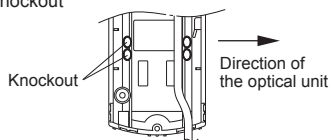

Knockout cutoff section

Rear view of the unit base

2 Direction of the optical unit

Rotate the optical unit approximately 45° away from the knockout area that you cut out in Step 1.

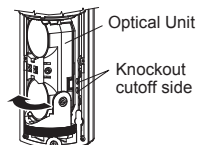

[Front view of the unit base]

Cut off the knockout of the unit base's wiring holes located on the side where the optical units of the transmitter and receiver face each other and on its opposite side with a nipper, etc. In the case of the front side, cut off the knockout located on either left or right side only.

3 Mounting and wiring of the heating unit

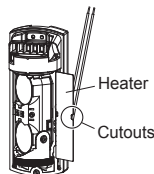

Align the heater as shown in the diagram and slide it into place behind the product's optical unit.

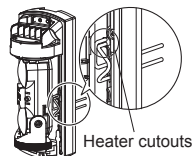

Route the heater cables through the heater cutouts and pass them through the wiring holes you cut in Step 1.

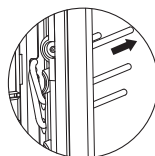

Pull the heater cables through the wiring holes until there is no slack remaining.

Waterproof material (included)

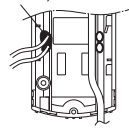

Seal the wiring holes with the waterproof material (included) so that there is no gap between the wire and the surrounding plastic. Repeat it for both holes.

Ensure that the wiring distance from the power supply is within the range shown in the table on the right. When using two or more units on one wire, the maximum length is obtained by dividing the wire length listed below by the number of units used.

Wiring distance	
Wire Size	Wiring Distance
AWG18 (0.83mm ²)	300 m (1000 ft.)
AWG16 (1.31mm ²)	500 m (1700 ft.)
AWG14 (2.09mm ²)	800 m (2600 ft.)

UL Listed applications, the heating unit was not investigated with the models AX-70/130/200TN, AX-100/200TF.

4 Connection using the connector



Connector

When connecting the lead wires to the wiring, make the connection using the supplied connector or soldering. Insert the wires into the connector and tighten the connections with pliers.

5 Mounting of the unit base and optical alignment

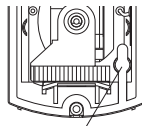

Unit Base Mounting Screw

8-2 BACK COVER : BC-3

1 Cutout of the knockout

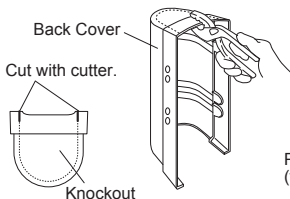

Cut off the knockout portion of the back cover with a cutter, etc.

2 Installation of mounting plate

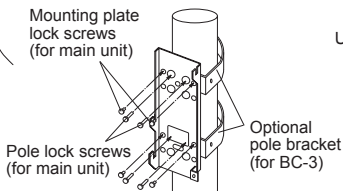

Note>>
Do not use pole bracket supplied with the unit

Fix the unit base body mounting-plate and the pole bracket for the option supplied with the back cover by using the supplied screws.

3 Installation of the unit base and the back cover

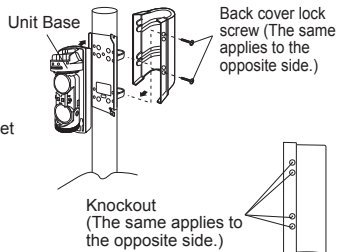

After mounting the units base, fix the back cover on the pole bracket by using the screws (4 pieces). Align the optical axis and check for the operation, then close the cover. (See "3. INSTALLATION")

8-3 POLE SIDE COVER : PSC-3

1 Cutout of the knockout

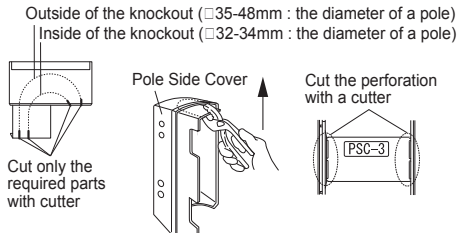

Cut the edge of the knockout (outside or inside) with a nipper and then break the knockout portion with a cutter. Also break the center bridge of the pole side cover along with the perforation.

2 Installation of the pole side covers

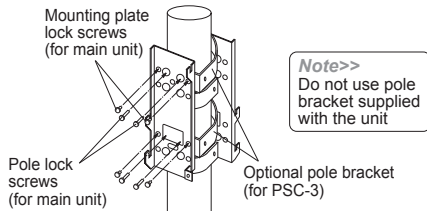

Note>>
Do not use pole bracket supplied with the unit

Fix the unit base body mounting-plate and the pole bracket for the option supplied with the pole side cover by using the supplied screws.

3 Installation of the pole side covers

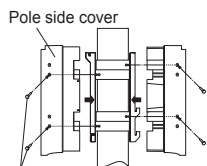

Note>>

When the pole side cover fix on the pole bracket, make sure the position of the screws.

Fix the pole side cover on the pole bracket by using the screws (8 pieces).

Pole side cover lock screw (The same applies to the opposite side.)

4 Mounting of the unit base

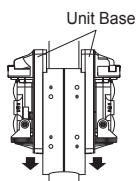

After mounting the units base, align the optical axis and check for the operation, then close the cover. (See "3. INSTALLATION")

9 TROUBLESHOOTING

Problem	Possible Cause	Corrective Action
LEDs on the transmitter are not illuminated.	Inappropriate power supply voltage	Check the voltage and make sure that it is between 10.5 and 28VDC.
	Disconnection in power line	Check the wiring
	Inappropriate wiring distance or wire diameter	See "2. Wiring distance between power supply and detector" of "4. WIRE CONNECTIONS", and check the wiring distance.
"Alarm Indicator" is not illuminated even if the beam is blocked in front of the receiver.	Inappropriate power supply voltage	Check the voltage and make sure that it is between 10.5 and 28VDC.
	Inappropriate wiring distance or wire diameter	See "2. Wiring distance between power supply and detector" of "4. WIRE CONNECTIONS", and check the wiring distance.
	The beams are reflecting off the floor and wall of a building, and entering the receiver.	Align the optical axis again. If "Alarm Indicator" is not turned on yet, remove the reflecting objects or change the installation site.
	Not interrupting both upper and lower beams at the same time.	Interrupt both upper and lower beams at the same time.
Blocking the beam in front of the receiver illuminates the "Alarm Indicator" but does not activate the alarm.	Receiving any other beams from other transmitters.	Move the receiver to any other place where it does not receive any beam from other transmitters.
	Signal line short-circuited	Check the wiring
"Alarm Indicator" of the receiver does not go out.	Alarm contact welded	Repair the required. Contact the distributor or installer.
	Optical axis of transmitter and receiver not aligned.	See "5-1 OPTICAL ALIGNMENT" and make realignment.
Frost, snow or heavy rain cause false alarm	Object blocking the beam between transmitter and receiver	Remove the object or move the unit to a place without any object that may block the beam.
	Optical alignment not optimized	See "5-1 OPTICAL ALIGNMENT" and make realignment.
Alarm activated even if the light is not blocked	Object blocking the beam between transmitter and receiver	See "5-2 BEAM INTERRUPTION TIME" and set an appropriate interruption time
	Vehicle or plant blocking the beam between transmitter and receiver	Remove any object blocking the beam
	Surface of transmitter/receiver cover soiled	Clean the cover (wipe the cover with a soft cloth dampened with water or diluted neutral detergent)
	Inaccurate optical alignment	See "5-1 OPTICAL ALIGNMENT" and make realignment.
	Inappropriate location of installation	Change the location

• After above inspections, if there remains any problem, contact our dealer or installer immediately.

10 SPECIFICATIONS

ENGLISH

FRANÇAIS

DEUTSCH

ITALIANO

ESPAÑOL

PORTUGUÊS

10-1 SPECIFICATIONS

Name		Photoelectric detector				
Model		AX-70TN	AX-130TN	AX-200TN	AX-100TF	AX-200TF
Range		20 m (70 ft.)	40 m (130 ft.)	60 m (200 ft.)	30 m (100 ft.)	60 m (200 ft.)
Maximum arrival distance		200 m (700 ft.)	400 m (1300 ft.)	600 m (2000 ft.)	300 m (1000 ft.)	600 m (2000 ft.)
Detection method		Infrared beam interruption detection				
Selectable beam frequency					4 channel	
Interruption period		Variable between 50, 100, 250, 500msec (4 steps)				
Power input		10.5-28VDC				
Current draw (Transmitter+Receiver)		38mA (max.) T:17mA+R:21mA	41mA (max.) T:20mA+R:21mA	45mA (max.) T:24mA+R:21mA	44mA (max.) T:6mA+R:38mA	48mA (max.) T:10mA+R:38mA
Output	Alarm output	N.C. 28VDC, 0.2A (max.)			N.C./ N.O. 28VDC, 0.2A (max.)	
	Alarm period	2 sec (±1) nominal				
	D.Q.output				N.C. 28VDC, 0.2A (max.)	
	Tamper output	N.C. : open when cover is removed 28VDC, 0.1A (max.) (Receiver only) *				
Indicator	Alarm indicator (Receiver)	Alarm : ON (red), Light receiving : OFF			Alarm : ON (red) Light receiving : flicker (red) or OFF	
	Power (Transmitter)	Power ON : ON (green), Power OFF : OFF				
	Alarm memory				Memory : ON or flicker (red) (Indicator will remain lit for 55 minutes, 5 minutes after alarm output)	
Operating temperature		-35°C - +60°C (-31°F - +140°F) Use the optional heating unit (HU-3) under the environment of -25°C (-13 °F) or less minus.				
Environment humidity		95% max				
Alignment angle		±90°Horizontal, ±5°Vertica				
Mounting		Indoor/Outdoor, Wall/Pole mounting				
Weight		650 g (22.9 oz)			700 g (24.7 oz)	
International protection		IP65				
Packages		Transmitter (×1), Receiver (×1), Pole bracket (×4), Mounting plate lock screws (×8), Pole lock screws (×8), Wall mounting screws (×4)				

* The transmitter is also equipped with AX-70/130/200TN(BE) and AX-100/200TF(BE)

Name	Heating unit
Model	HU-3
Power input	24VAC/DC
Current draw	420mA (max.) (Per 1 unit)
Thermo switch	60°C (140°F)
Operating temperature	-35°C - +60°C (-31°F - +140°F)
Weight	12 g (0.4 oz) (Heater (×2))
Packages	Heater (×2), Connector (×4), Waterproof agent

Name	Back cover
Model	BC-3
Operating temperature	-35°C - +60°C (-31°F - +140°F)
Weight	150 g (5.3 oz) (Back Cover (×2))
Packages	Back cover (×2), Optional pole bracket (×4), Back cover lock screw (×8)

Name	Pole side cover
Model	PSC-3
Operating temperature	-35°C - +60°C (-31°F - +140°F)
Weight	110 g (3.9 oz) (Pole Side Cover (×2))
Packages	Pole side cover (×2), Optional pole bracket (×4), Pole side cover lock screw (×8)

AX-70/130/200TN, AX-100/200TF

ENGLISH

FRANÇAIS

DEUTSCH

ITALIANO

ESPAÑOL

PORTUGUÊS

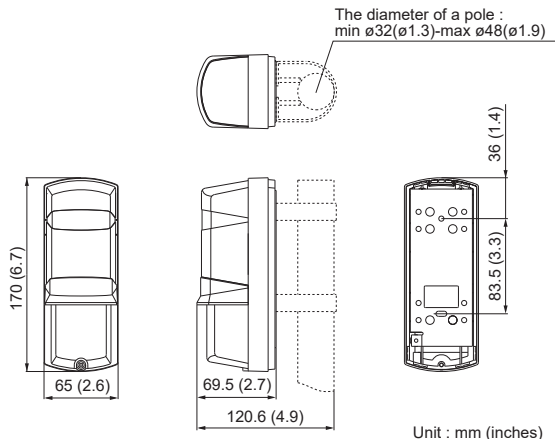

Unit : mm (inches)

BC-3

PSC-3

HU-3

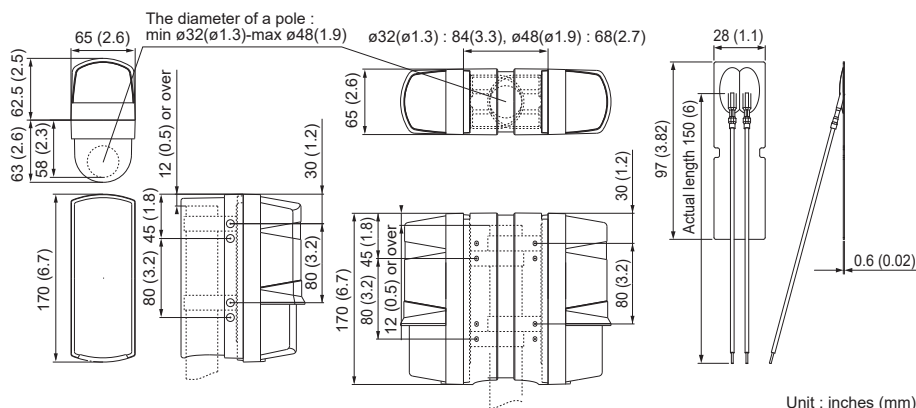

Unit : inches (mm)

■ EU contact information

Manufacturer:

OPTEX CO., LTD.
5-8-12 Ogoto, Otsu, Shiga, 520-0101 JAPAN

Authorised representative in Europe:

OPTEX (EUROPE) LTD. / EMEA HEADQUARTERS
Marandaz House 1 Cordwallis Park, Clivemont Road,
Maidenhead, Berkshire, SL6 7BU U.K.

NOTE

These units are designed to detect an intruder and activate an alarm control panel. Being only a part of a complete system, we cannot accept responsibility for any damages or other consequences resulting from an intrusion.



OPTEX CO., LTD.(JAPAN)

URL: <http://www.optex.net>

OPTEX INC. (U.S.)
URL: <http://www.optexamerica.com>

OPTEX SECURITY SAS (France)
URL: <http://www.optex-security.com>

OPTEX KOREA CO.,LTD. (Korea)
URL: <http://www.optexkorea.com>

OPTEX DO BRASIL LTDA. (Brazil)
URL: <http://www.optex.net/br/les/sec>

OPTEX SECURITY Sp.z o.o. (Poland)
URL: <http://www.optex.com.pl>

OPTEX (DONGGUAN) CO.,LTD.
SHANGHAI OFFICE (China)
URL: <http://www.optexchina.com>

OPTEX (EUROPE) LTD. / EMEA HQ (U.K.)
URL: <http://www.optex-europe.com>

OPTEX PINNACLE INDIA, PVT., LTD. (India)
URL: <http://www.optex.net/in/en/sec>

OPTEX (Thailand) CO., LTD. (Thailand)
URL: <http://www.optex.net/th>

OPTEX TECHNOLOGIES B.V. (The Netherlands)
URL: <http://www.optex.eu>