

MRK Series

19" gangable enclosure

narrow design for large multi-bay jobs

features:

- Fully welded construction provides the following weight capacities: UL Listed load capacity: 2,500 lbs., seismic certified capacity - 1,050 lbs.
- 22" OD width with multiple depths available
- 1/2", 3/4", 1" & 1-1/2" electrical knockouts on split rear plates top & bottom, easily removable for cable pass-through, top plates additionally include UHF/VHF knockouts
- Two wide pairs of 10-32 threaded rackrail with numbered rackspace increments
- Optional solid, fully vented, plexi and vented plexi front doors available
- Open top with configurable top panel options
- Durable black textured powder coat finish
- Seismic certified (when used with MRK-Z4 option) with an Ip value of 1.5
- UL Listed in the US and Canada



MRK-4426

specifications:

EIA compliant 19" gangable equipment rack shall be Middle Atlantic Products model # MRK-___ (refer to chart). Overall dimensions shall be ___"H x 22"W x ___"D (refer to chart). Useable height shall be ___ rackspace, useable depth shall be ___" (refer to chart). Fully welded construction shall provide a UL Listed load capacity of 2,500 lbs. Rack shall be constructed of steel and all structural elements shall be finished in a durable black powder coat. Rack shall include a locking, latching rear door. Rack shall come equipped with two pairs of steel rackrail with tapped 10-32 mounting holes in universal EIA spacing, black e-coat finish and numbered rackspace (select models also available with cage nut style rackrail, refer to chart). Rack shall have removable split rear knockout panels with 1/2", 3/4", 1" and 1-1/2" electrical knockouts and top BNC knockouts for UHF/VHF antennae. Grounding and bonding stud shall be 1/4-20 threaded, installed in base of enclosure. MRK Series enclosures shall satisfy the 2007 & 2010 CBC; 2006, 2009 & 2012 IBC; ASCE 7-05 (2005 Edition) & ASCE 7-10 (2010 Edition) and the 2006 & 2009 editions of NFPA 5000 for use in areas of high seismicity, Seismic Use Group III, Zone 4 or Seismic Design Category (SDC) "D" with lateral force requirements for protecting 1,050 lbs. of essential equipment in locations with the highest level of seismicity and top floor or rooftop installations with an Importance factor (Ip) of 1.5 when used with MRK-Z4 seismic floor anchor bracket. Rack shall be OSHPD approved for fixed equipment anchorage in California healthcare facilities. Rack shall be UL Listed in the US and Canada. MRK shall be GREENGUARD Gold certified. MRK shall be manufactured by an ISO 9001 and ISO 14001 registered company. MRK enclosure shall be warranted to be free from defects in material or workmanship under normal use and conditions for the lifetime of the rack.

Customizable specification clips available at middleatlantic.com



PRODUCT CERTIFIED FOR
LOW CHEMICAL EMISSIONS
UL COM/GG
UL 2818



options:

- Front doors shall be reinforced steel, model # FD-x (solid), VFD-x (vented, 25% open area), LVFD-x (vented, 64% open area), PFD-x (plexi), PVFD-44 (vented plexi) (x = # of rackspace)
- Vented steel rear doors shall be model # MW-VRD-44 (vented top and bottom), MW-LVRD-x (vented, 64% open area, excludes 24 and 37 space rack) (x = # of rackspace), MW-CLVRD-44 (split rear door, vented, 79% open area)
- Removable keylocked side panels shall be model # SPN-x (267/312/36/423) (x = # of rackspace), 267 = 26-1/2" cabinet depth, 312 = 31-1/2" cabinet depth, 36 = 36" cabinet depth, 423 = 42" cabinet depth
- Top panels shall be steel, multiple styles available including model # MW-ST (solid), MW-10FT (10" fan), MW-4FT (four 4-1/2" fans), MW-6FT (three 6" fans), MW-VT (vented), MW-LA (accepts 6" and 12" wide cable ladders) and MV-PVT (26/31/36/42) (Vented pagoda adds 1.41" to top of rack)
- Caster base shall add 1" to overall height, featuring four casters with a 1,300 lb. weight capacity, UL Listed in the US and Canada. Model # CBS-MRK-x (x = cabinet depth)
- Fine floor friendly caster base shall have a 700 lb. weight capacity. Model # CBS-MRK-xR (x = cabinet depth)
- Rail bracket adapters shall allow for mounting of panels vertically between rackrail brackets. Available for 44 space enclosures. Model # RBA-MV44-2, 2 rackspace.
- Seismic Zone-4 and Seismic Use Group III compliancy floor anchor kit shall be model # MRK-Z4
- Slide-out AXS enclosure option available (See AXS Spec sheet # 96-0555)

what **great systems** are built on.™

A brand of **legrand**



Middle Atlantic Products
middleatlantic.com | middleatlantic.com

MRK Series

configured a/v enclosure

configured A/V enclosure ships complete with the most commonly used accessories

includes:

- Integrated fan top with proportional speed fan controller
- Configurable rear door with bottom vent, solid locking front door
- 3-1/4" wide, 44 space vertical lacer strip
- Six horizontal lacer bars
- Twelve 8" Velcro® cable management straps
- Thin power strip, 20 Amp, 20 outlet with cord
- Leveling feet
- 100 qty. 10-32 mounting hardware
- Available with or without sides
- Ganging hardware available for add-a-bay models without sides



MRK-4426-AV-AB

specifications:

EIA compliant 19" gangable equipment rack shall be Middle Atlantic Products model # MRK-___-AV (refer to chart). Overall dimensions of rack shall be 83-1/8" H x ___" W x ___" D (refer to chart). Useable height shall be 44 rackspaces, useable depth shall be ___" (refer to chart). Fully welded construction shall provide static capacity of 10,000 lbs. and a UL Listed load capacity of 2,500 lbs. Rack shall be constructed of the following materials: top and bottom shall be 14-gauge steel, horizontal braces shall be 16-gauge steel, solid front door shall be 18-gauge steel and all structural elements shall be finished in a durable black powder coat. Rack shall include a locking, latching rear door. Rack shall come equipped with two pairs of 11-gauge steel rackrail with tapped 10-32 mounting holes in universal EIA spacing, black e-coat finish and numbered rackspaces. Rack shall include 100 qty. 10-32 mounting screws. Rack shall be equipped with one vertical lacer strip, Middle Atlantic Products model # LACE-44-OP. The LACE-44-OP is 3-1/4" wide and the useable height is 44 rackspaces. Rack shall also include four 'L' shaped straight and two 4" offset horizontal lacer bars and twelve, 8" Velcro® straps for cable management. Models intended for ganging (MRK-___-AV-AB) (refer to chart) shall include ganging hardware for multi-bay installations. Rack shall feature integrated fan top, Middle Atlantic Products model # MW-10FT-FC for active thermal management. MW-10FT-FC shall feature proportional speed fan control and maximum airflow shall be 550 CFM. Rack shall have removable split rear knockout panels with 1/2", 3/4", 1" and 1-1/2" electrical knockouts and top BNC knockouts for UHF/VHF antennae. Grounding and bonding stud shall be 1/4-20 threaded, installed in base of enclosure. MRK Series enclosures shall satisfy the 2007 & 2010 CBC; 2006, 2009 & 2012 IBC; ASCE 7-05 (2005 Edition) & ASCE 7-10 (2010 Edition) and the 2006 & 2009 editions of NFPA 5000 for use in areas of high seismicity, Seismic Use Group III, Zone 4 or Seismic Design Category (SDC) "D" with lateral force requirements for protecting 1,050 lbs. of essential equipment in locations with the highest level of seismicity and top floor or rooftop installations with an Importance factor (Ip) of 1.5 when used with MRK-Z4 seismic floor anchor bracket. Rack shall be OSHPD approved for fixed equipment anchorage in California healthcare facilities. Rack shall include a high-density thin power distribution and shall be Middle Atlantic Products model # PDT-2020C-NS with 20 outlets and 20 amps. Thin power distribution shall be 72-3/4" long x 1" deep x 1.9" wide. JBox shall be 2" deep x 2" wide. Thin power distribution shall feature 20 NEMA 5-20R outlets. Corded power strip includes 20-amp protection and mounting hardware. Corded model shall be terminated with 10 foot power cord and NEMA 5-20P plug. PDT Series shall feature a black anodized finish. MRK and PDT Series shall be UL Listed in the US and Canada. MRK-___-AV shall be manufactured by an ISO 9001 and ISO 14001 registered company. PDT-2020C-NS and MW-10FT-FC shall be warrantied to be free from defects in material or workmanship under normal use and conditions for a period of 3 years. MRK enclosure shall be warrantied to be free from defects in material or workmanship under normal use and conditions for the lifetime of the rack.

Customizable specification clips available at middleatlantic.com



PRODUCT CERTIFIED FOR LOW CHEMICAL EMISSIONS
UL.COM/GG
UL 2818

SEISMIC CERTIFIED



ECO PASS PORT®

what **great systems** are built on.™

A brand of **legrand**

Middle Atlantic Products

middleatlantic.com | middleatlantic.com

MRK Series

configured NVR/DVR enclosures

complete NVR / DVR enclosure addresses the cable and thermal management needs of both network and digital video recording devices

includes:

- Two pairs cage nut style rackrail (NVR enclosure)
- Two pairs 10-32 threaded rackrail (DVR enclosure)
- One pair of cage nut style Z-rail adapters (NVR enclosure)
- Fully vented top
- Fully perforated vented front door and vented split rear door
- 3-1/4" wide, 44 space vertical lacer strip
- Six horizontal lacer bars
- Twelve 8" Velcro® cable management straps
- Thin power strip, 20 Amp, 20 outlet with cord
- One each 1 space and 2 space brush grommet
- Leveling feet
- 100 qty. 6mm threaded cage nuts and rack screws (NVR enclosure)
- 50 qty. 10-32 threaded cage nuts and rack screws (NVR enclosure)
- 100 qty. 10-32 mounting hardware (DVR enclosure)
- Available with or without sides
- Ganging hardware available for add-a-bay models without sides



MRK-4436-NVR-AB

specifications:

EIA compliant 19" gangable equipment rack shall be Middle Atlantic Products model # MRK- ___-DVR (NVR) (refer to chart). Overall dimensions of rack shall be 83-1/8" H x ___" W x ___" D (refer to chart). Useable height shall be 44 rackspace, useable depth shall be ___" (refer to chart). Fully welded construction shall provide a static capacity of 10,000 lbs. and a UL Listed load capacity of 2,500 lbs. Rack shall be constructed of the following materials: top and bottom shall be 14-gauge steel, horizontal braces shall be 16-gauge steel, perforated vented front door shall be 18-gauge steel and all structural elements shall be finished in a durable black powder coat. Rack shall include a locking, latching rear door. Rack shall come equipped with two pairs of 11-gauge steel rackrail with tapped mounting holes in universal EIA spacing, black e-coat finish and numbered rackspace. Rack shall include 100 qty. 10-32 mounting screws (DVR enclosure) or 100 qty. 6mm cage nuts and rack screws with 50 qty. 10-32 threaded cage nuts and rack screws (NVR enclosure). Rack shall be equipped with one vertical lacer strip, Middle Atlantic Products model # LACE-44-OP. The LACE-44-OP is 3-1/4" wide and the useable height is 44 rackspace. Rack shall also include four 'L' shaped straight and two 4" offset horizontal lacer bars and twelve, 8" Velcro® straps for cable management. Models intended for ganging (MRK-___-AB) (refer to chart) shall include ganging hardware for multi-bay installations. Rack shall have removable split rear knockout panels with 1/2", 3/4", 1" and 1-1/2" electrical knockouts and top BNC knockouts for UHF/VHF antennae. Grounding and bonding stud shall be 1/4-20 threaded, installed in base of enclosure. MRK Series enclosures shall satisfy the 2007 & 2010 CBC; 2006, 2009 & 2012 IBC; ASCE 7-05 (2005 Edition) & ASCE 7-10 (2010 Edition) and the 2006 & 2009 editions of NFPA 5000 for use in areas of high seismicity, Seismic Use Group III, Zone 4 or Seismic Design Category (SDC) "D" with lateral force requirements for protecting 1,050 lbs. of essential equipment in locations with the highest level of seismicity and top floor or rooftop installations with an Importance factor (Ip) of 1.5 when used with MRK-Z4 seismic floor anchor bracket. Rack shall be OSHPD approved for fixed equipment anchorage in California healthcare facilities. Rack shall include a high-density thin power distribution and shall be Middle Atlantic Products model # PDT-2020C-NS with 20 outlets and 20 amps. Thin power distribution shall be 72-3/4" long x 1" deep x 1.9" wide. J-Box shall be 2" deep x 2" wide. Thin power distribution shall feature 20 NEMA 5-20R outlets. Corded power strip includes 20 amp protection and mounting hardware. Corded model shall be terminated with 10 foot power cord and NEMA 5-20P plug. PDT Series shall feature a black anodized finish. MRK and PDT Series shall be UL Listed in the US and Canada. MRK-___-DVR (NVR) shall be GREENGUARD Gold Certified. MRK-___-DVR (NVR) shall be manufactured by an ISO 9001 and ISO 14001 registered company. PDT-2020C-NS shall be warranted to be free from defects in material or workmanship under normal use and conditions for a period of 3 years. MRK enclosure shall be warranted to be free from defects in material or workmanship under normal use and conditions for the lifetime of the rack.

Customizable specification clips available at middleatlantic.com



PRODUCT CERTIFIED FOR
LOW CHEMICAL EMISSIONS
UL.COM/GG
UL 2818



what great systems are built on.™

A brand of **legrand**

MR
Middle Atlantic Products

middleatlantic.com | middleatlantic.com

MRK Series

basic dimensions

all dimensions in inches unless otherwise noted [all dimensions in brackets are in millimeters]

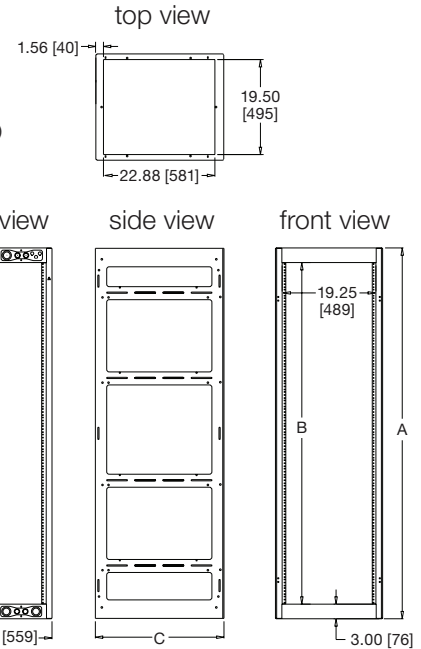
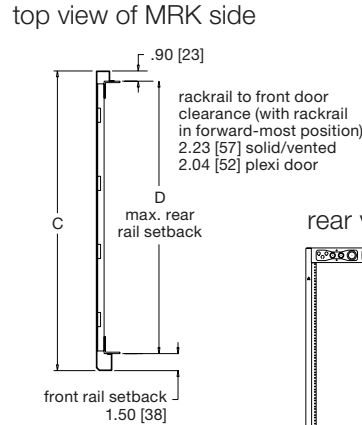
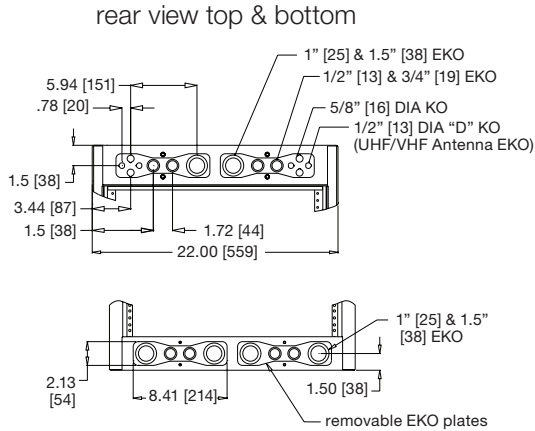

Part #	A Overall	B Useable Height	C Overall Depth	D Useable Depth
MRK-4426	83.125" [2112]	77.125" [1959]	26.40" [671]	24.00" [610]
MRK-4426-AV-AB*	83.125" [2112]	77.125" [1959]	26.40" [671]	24.00" [610]
MRK-4026	76.125" [19341]	70.125" [1781]	26.40" [671]	24.00" [610]
MRK-3726	70.875" [1800]	64.875" [1648]	26.40" [671]	24.00" [610]
MRK-2426	48.125" [1223]	42.125" [1070]	26.40" [671]	24.00" [610]
MRK-4431**	83.125" [2112]	77.125" [1959]	31.40" [798]	29.00" [737]
MRK-4431-AV-AB*	83.125" [2112]	77.125" [1959]	31.40" [798]	29.00" [737]
MRK-4431-DVR-AB*	83.125" [2112]	77.125" [1959]	31.40" [798]	29.00" [737]
MRK-4031	76.125" [1934]	70.125" [1781]	31.40" [798]	29.00" [737]
MRK-3731	70.875" [1800]	64.875" [1648]	31.40" [798]	29.00" [737]
MRK-2431	48.125" [1223]	42.125" [1070]	31.40" [798]	29.00" [737]
MRK-4436**	83.125" [2112]	77.125" [1959]	36.00" [914]	33.60" [853]
MRK-4436-NVR-AB*	83.125" [2112]	77.125" [1959]	36.00" [914]	33.60" [853]
MRK-4036**	76.125" [1934]	70.125" [1781]	36.00" [914]	33.60" [853]
MRK-3736	70.875" [1800]	64.875" [1648]	36.00" [914]	33.60" [853]
MRK-2436	48.125" [1223]	42.125" [1070]	36.00" [914]	33.60" [853]
MRK-4442**	83.125" [2112]	77.125" [1959]	42.00" [1067]	39.60" [1006]
MRK-4042**	76.125" [1934]	70.125" [1781]	42.00" [1067]	39.60" [1006]

* Denotes that AV, DVR and NVR models are also available configured with optional side panels (remove AB suffix for part no. e.g. MRK-4426-AV). Side panels add 1-5/16" [33mm] to overall width of rack.
 ** Available configured with 2 pairs cage nut style rackrail, suffix model number with 'PRO'.

floor mounting locations

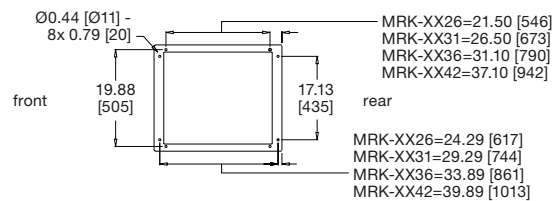

Top Options

(removable plate opening accommodates 2 space panel)

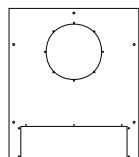

MW-10FT accepts 10" fan
 MW-10FT-550CFM includes 10" fan
 MW-10FT-FC includes 10" fan and fan controller

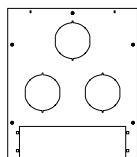

MW-6FT accepts 6" fans
 MW-6FT-660CFM includes 6" fans

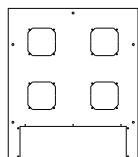

MW-4FT accepts 4-1/2" fans
 MW-4FT-380CFM includes 4-1/2" fans
 MW-4QFT-FC includes 4-1/2" quiet fans and fan controller

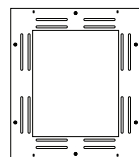

MW-LA accepts 6", 9" and 12" width cable ladder



MW-ST solid



MW-VT slot vent

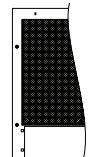

MW-LVT 64% open area

what great systems are built on.™

A brand of **legrand**



Middle Atlantic Products

middleatlantic.com | middleatlantic.ca