

ERK Series

enclosure

The ERK Series 19" welded stand-alone / gangable enclosures. Advanced manufacturing techniques provide highest quality and lowest price.

features:

- Fully welded construction
- 2,500 lb. weight capacity
- 1/8" thick structural steel internal braces
- UL Listed in the US and Canada
- Seismic certified (when used with ERK-Z4 option) with an Ip value of 1.5
- 22" OD width, available 20", 25" or 28" OD depth
- 1/2", 3/4", 1" & 1-1/2" electrical knockouts on removable split rear plates top and bottom, easily removable for cable pass-through. Top plates additionally include UHF / VHF knockouts
- Standard front, optional rear 11-gauge 10-32 threaded, fully adjustable rackrail with numbered rackspace increments
- Keylocked solid rear door standard, optional vented rear doors available
- Optional front doors available
- Configurable top options on 44, 40, and 35 space sizes
- Durable black textured powder coat finish



ERK-4425

specifications:

EIA compliant 19" stand-alone / gangable equipment rack shall be Middle Atlantic Products model # ERK-___-___(see chart for available models). Overall dimensions of rack shall be ___"H x ___"W x ___"D (refer to chart). Useable height shall be ___ rackspaces, useable depth shall be ___" (refer to chart). Rack shall be of fully welded construction. Weight capacity shall be 2,500 lbs. ERK shall be finished in a durable black powder coat. ERK shall come equipped with one pair of fully adjustable 11-gauge steel rackrail with tapped 10-32 mounting holes in universal EIA spacing, black e-coat finish and numbered rackspaces. ERK shall include solid locking rear door standard and solid sides with vertical slotted vent pattern at top and bottom (and laser knockouts for cable pass-through on 44, 40, and 35 space models). Top and bottom of ERK shall feature vertical slotted vent pattern. ERK shall have removable split rear knockout panels with 1/2", 3/4", 1", and 1-1/2" electrical knockouts installed in base and a removable rear knockout panel with 1/2", 3/4", 1", and 1-1/2" electrical knockouts and BNC knockouts for UHF/VHF antennae installed in top. Grounding and bonding stud shall be 1/4-20 threaded (1 location), bonding stud shall be 10-32 threaded (3 locations). ERK Series enclosures shall satisfy the 2005 & 2010 Editions of ASCE Standard 7; 2006, 2009 & 2012 editions of the IBC; 2007, 2010 & 2013 editions of the CBC; 2010 editions of the NBC and 2012 edition of the CBC for use in areas of high seismicity, Occupancy Category IV facilities. Seismic design force is an assumed Site Class D soil conditions, and top floor or rooftop installations. Design for High Importance or Post-disaster installation uses an importance factor (Ip or Ie) of 1.5 when used with ERK-Z4 seismic floor anchor bracket. ERK shall be UL Listed in the US to UL2416 (NWIN) and Canada to CSA C22.2 No. 60950-1. ERK shall be GREENGUARD Gold Certified. ERK shall be manufactured by an ISO 9001 and ISO 14001 registered company. ERK shall be warranted to be free from defects in material or workmanship under normal use and conditions for the lifetime of the product.

Customizable specification clips available at middleatlantic.com



PRODUCT CERTIFIED FOR
LOW CHEMICAL EMISSIONS
UL COM/GG
UL 2818



options:

- Front doors shall be model #FD-XX (solid), VFD-XX (vented, 22% open area), LVFD-xx (vented 63% open area-not available for 27 space rack) PVFD-44 (vented plexi), (X=# of rackspaces of ERK rack)
- Rear door, vented, shall be ERK-VRD-XX, Cable management shall be ERK-RDC-XX (XX= # of rackspaces of ERK Rack)
- Top panels for 35, 40 or 44 space ERK, multiple styles available including model #ERK-ST (solid), ERK-10FT (10" fan), ERK-6FT (two 6" fans) ERK-4FT (three 4-1/2" fans), ERK-VT (vented) and ERK-LVT (large perf vented) see A&E spec 96-01063 for more details
- Caster base, four casters shall have a total weight capacity of 1300 pounds, model # CBS-ERK-YY (Y= cabinet depth), raises racks 3.9" (commercial grade) or 4.1" (fine floor)
- Rear rail kit, 11-gauge, 10-32 threaded, sold in pairs, hardware included, model #ERK-RRXX (X=# of rackspaces)
- Seismic compliancy floor anchor kit, model # ERK-Z4
- 18, 21 and 27 space ERK come preconfigured with solid top that includes knockouts to accommodate up to two 4-1/2" fans, or included vent panels
- Optional bonding kit for UL-2416 (NWIN) compliance shall be PET-K-RD (for rear door to enclosure), PET-K-RDC (for cable management rear door to enclosure), PET-K-EXT (for extender bay to enclosure)
- Extender bay adds 3" of usable depth, front mount shall be ERK-(44, 40)-F-EXT3, rear shall be ERK-(44,40)-R-EXT3
- Grommet for 4" electrical knockout in side of ERK shall be model # GK4 and include 4 pieces
- Gland grommet for 4" electrical knockout in side of ERK shall be model #GK-4G. 4 Pieces.
- Slide out option available (See AXS Spec sheet 96-055S)

what **great systems** are built on.™

A brand of **legrand**

Middle Atlantic Products

middleatlantic.com | middleatlantic.com

96-038 / rev s / 5-8-20

ERK Series

configured A/V enclosure

Configured A/V enclosure ships complete with the most commonly used accessories.

features:

- Integrated fan top
- Configurable rear door with bottom vent, solid locking front door
- 3-1/4" wide vertical lacer strip (height varies based on model)
- Six horizontal lacer bars
- Twelve 8" Velcro® cable management straps
- Thin power strip, 20 Amp, 20 outlet with cord (44 space enclosures) or 2 qty. thin power strip, 20 Amp, 10 outlet with cord (35 & 40 space enclosures)
- Leveling feet
- 100 qty. 10-32 mounting hardware



ERK-4425-AV

specifications:

EIA compliant 19" stand-alone / gangable equipment rack shall be Middle Atlantic Products model # ERK-___-___-AV (see chart for available models). Overall dimensions of rack shall be ___" H x ___" W x 25" D (refer to chart). Useable height shall be ___ rackspaces, useable depth shall be 23-1/2". Rack shall be of fully welded construction. Weight capacity shall be 2,500 lbs. ERK shall be finished in a durable black powder coat. Solid front door and vented, locking and latching rear door and all structural elements shall be finished in a durable black powder coat. Rack shall come equipped with two pairs of 11-gauge steel rackrail with tapped 10-32 mounting holes in universal EIA spacing, black e-coat finish and numbered rackspaces. Rack shall include 100 qty. 10-32 mounting screws. Rack shall be equipped with one 3-1/4" vertical lacer strip Middle Atlantic Products model # LACE-___-OP (refer to chart), four 'L' shaped straight and two 4" offset horizontal lacer bars and twelve, 8" Velcro® straps for cable management. The ERK shall have a solid locking rear door standard and solid side panels with vertical slotted vent pattern at top and bottom with laser knockouts for cable pass-through. Rack shall have feature integrated fan top, Middle Atlantic Products model # ERK-4FT-285CFM for active thermal management. The ERK-4FT-285CFM shall consist of three 4-1/2" fans and airflow shall be 285 CFM. Rack shall have removable split rear knockout panels with 1/2", 3/4", 1" and 1-1/2" electrical knockouts and top BNC knockouts for UHF/VHF antennae. Grounding and bonding stud shall be 1/4-20 threaded (1 location), bonding stud shall be 10-32 threaded (3 locations). ERK Series enclosures shall satisfy the 2005 & 2010 Editions of ASCE Standard 7; 2006, 2009 & 2012 editions of the IBC; 2007, 2010 & 2013 editions of the CBC; 2010 editions of the NBC and 2012 edition of the BCBC for use in areas of high seismicity, Occupancy Category IV facilities. Seismic design force is an assumed Site Class D soil conditions, and top floor or rooftop installations. Design for High Importance or Post-disaster installation uses an importance factor (I_p or I_e) of 1.5 when used with ERK-Z4 seismic floor anchor bracket. ERK-___-AV shall include a high-density thin power distribution and shall be Middle Atlantic Products model # PDT-___-NS with ___ outlets and 20 amps (refer to chart). Thin power distribution shall be ___" long (refer to chart) x 1" deep x 1.9" wide. J-Box shall be 2" deep x 2" wide. Thin power distribution shall feature ___ NEMA 5-20R outlets. Corded power strip includes 20 amp protection and mounting hardware. Corded model shall be terminated with 10-foot power cord and a NEMA 5-20P plug. PDT Series shall feature a black anodized finish. ERK shall be UL Listed in the US to UL2416 (NWIN) and Canada to CSA C22.2 No. 60950-1. ERK shall be GREENGUARD Gold Certified. ERK shall be manufactured by an ISO 9001 and ISO 14001 registered company. ERK shall be warranted to be free from defects in material or workmanship under normal use and conditions for the lifetime of the product.

Customizable specification clips available at middleatlantic.com



PRODUCT CERTIFIED FOR
LOW CHEMICAL EMISSIONS
UL.COM/GG
UL 2818



what **great systems** are built on.™

A brand of **legrand**

Middle Atlantic Products

middleatlantic.com | middleatlantic.com

ERK Series

basic dimensions

all dimensions in inches unless otherwise noted [all dimensions in brackets are in millimeters]

top view of ERK side sectional view

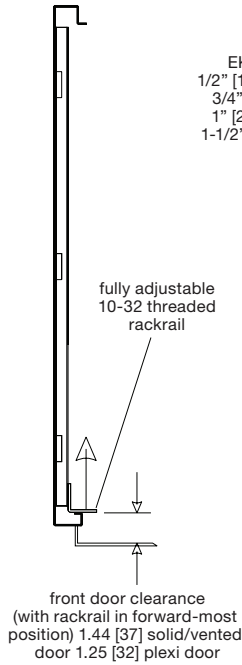

rear view

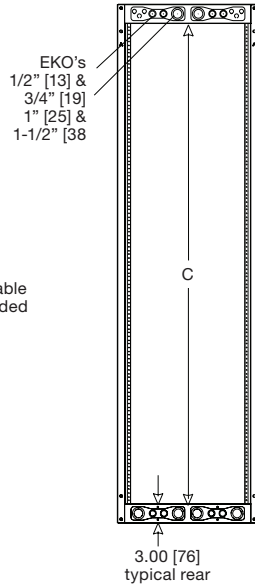

side view

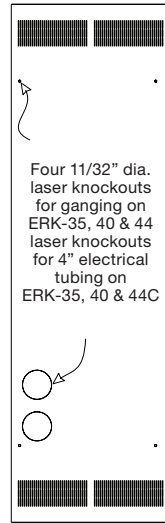

front view

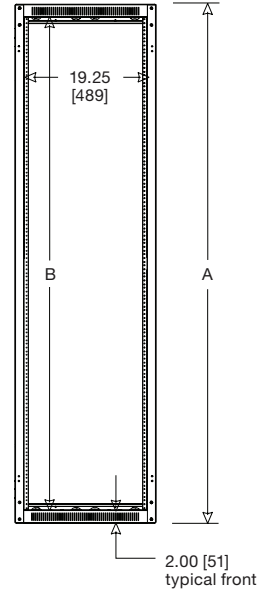

top view
ERK-18XX / ERK-21XX / ERK-27XX

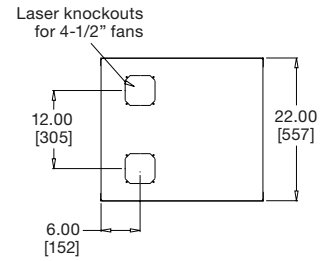

top view
ERK-35XX / ERK-40XX / ERK-44XX

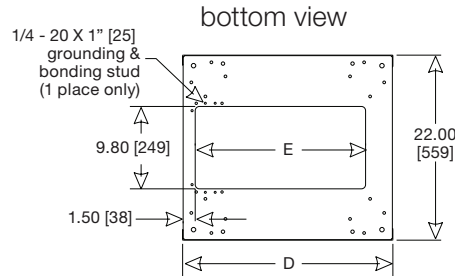
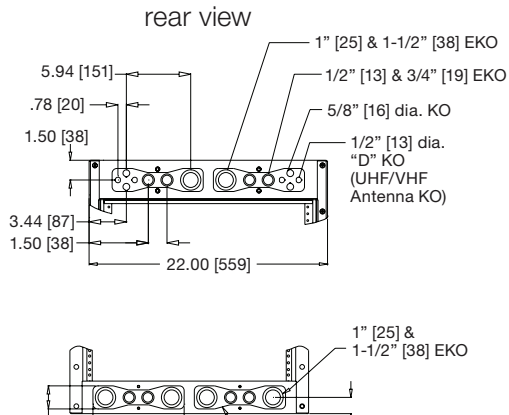
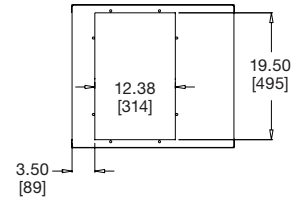

bottom view
mounting holes

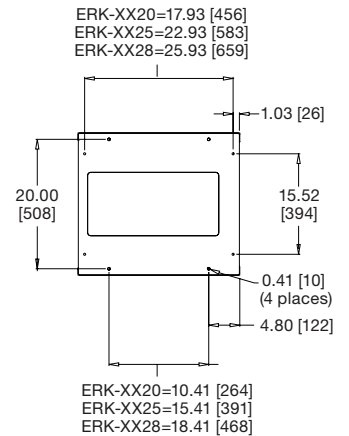

ERK Series

basic dimensions

all dimensions in inches unless otherwise noted [all dimensions in brackets are in millimeters]

Part #	A Overall Height	B Useable Height	C Rear Height	D Overall Depth	E Bottom Opening Depth	Useable Depth
ERK-4428	81.130 [2061]	77.130 [1959]	75.130 [1908]	28.00 [711]	23.25 [591]	26.47 [672]
ERK-4028	74.130 [1883]	70.130 [1781]	68.130 [1731]	28.00 [711]	23.25 [591]	26.47 [672]
ERK-3528	65.380 [1661]	61.380 [1559]	59.380 [1508]	28.00 [711]	23.25 [591]	26.47 [672]
ERK-2728	51.380 [1305]	47.380 [1203]	45.380 [1153]	28.00 [711]	23.25 [591]	26.47 [672]
ERK-2128	40.880 [1038]	36.880 [937]	34.880 [886]	28.00 [711]	23.25 [591]	26.47 [672]
ERK-1828	35.630 [905]	31.630 [803]	29.630 [753]	28.00 [711]	23.25 [591]	26.47 [672]
ERK-4425	81.125 [2061]	77.125 [1959]	75.125 [1908]	25.00 [635]	20.25 [514]	23.47 [596]
ERK-4025	74.125 [1883]	70.125 [1781]	68.125 [1703]	25.00 [635]	20.25 [514]	23.47 [596]
ERK-3525	65.375 [1661]	61.375 [1559]	59.375 [1508]	25.00 [635]	20.25 [514]	23.47 [596]
ERK-2725	51.375 [1305]	47.375 [1203]	45.375 [1153]	25.00 [635]	20.25 [514]	23.47 [596]
ERK-2125	40.875 [1038]	36.875 [937]	34.875 [886]	25.00 [635]	20.25 [514]	23.47 [596]
ERK-1825	35.625 [905]	31.625 [803]	29.625 [752]	25.00 [635]	20.25 [514]	23.47 [596]
ERK-4420	81.125 [2061]	77.125 [1959]	75.125 [1908]	20.00 [508]	15.25 [387]	18.47 [469]
ERK-4020	74.125 [1883]	70.125 [1781]	68.125 [1703]	20.00 [508]	15.25 [387]	18.47 [469]
ERK-3520	65.375 [1661]	61.375 [1559]	59.375 [1508]	20.00 [508]	15.25 [387]	18.47 [469]
ERK-2720	51.375 [1305]	47.375 [1203]	45.375 [1153]	20.00 [508]	15.25 [387]	18.47 [469]
ERK-2120	40.875 [1038]	36.875 [937]	34.875 [886]	20.00 [508]	15.25 [387]	18.47 [469]
ERK-1820	35.625 [905]	31.625 [803]	29.625 [752]	20.00 [508]	15.25 [387]	18.47 [469]
ERK-4425-AV	81.125 [2061]	77.125 [1959]	75.125 [1908]	25.00 [635]	20.25 [514]	23.47 [596]
ERK-4025-AV	74.125 [1883]	70.125 [1781]	68.125 [1703]	25.00 [635]	20.25 [514]	23.47 [596]
ERK-3525-AV	65.375 [1661]	61.375 [1559]	59.375 [1508]	25.00 [635]	20.25 [514]	23.47 [596]

top view (35, 40, and 44 space only)

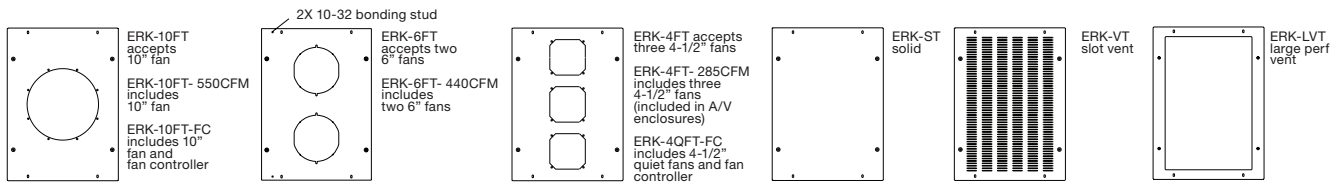

ERK A/V Enclosure Power Distribution

Rack Part #	Part #	Terminated	Circuit	Outlets	Overall Length	Qty
ERK-4025-AV / ERK-3525-AV	PDT-1020C-NS 5-20P	20 Amp	10, 5-20R	37.75 [959]	2	26.47 [672]
ERK-4425-AV	PDT-2020C-NS 5-20P	20 Amp	20, 5-20R	72.75 [1848]	1	23.47 [596]

ERK A/V Enclosure Vertical Lacer Bar Chart

Part #	Lacer Bar	# of Rackspace	Width
ERK-4425-AV	LACE-44-OP	44	3.25 [83]
ERK-4025-AV	LACE-40-OP	40	3.25 [83]
ERK-3525-AV	LACE-37-OP	37	3.25 [83]

what great systems are built on.™

A brand of **legrand**



Middle Atlantic Products

middleatlantic.com | middleatlantic.ca

ERK Series

basic dimensions

all dimensions in inches unless otherwise noted [all dimensions in brackets are in millimeters]

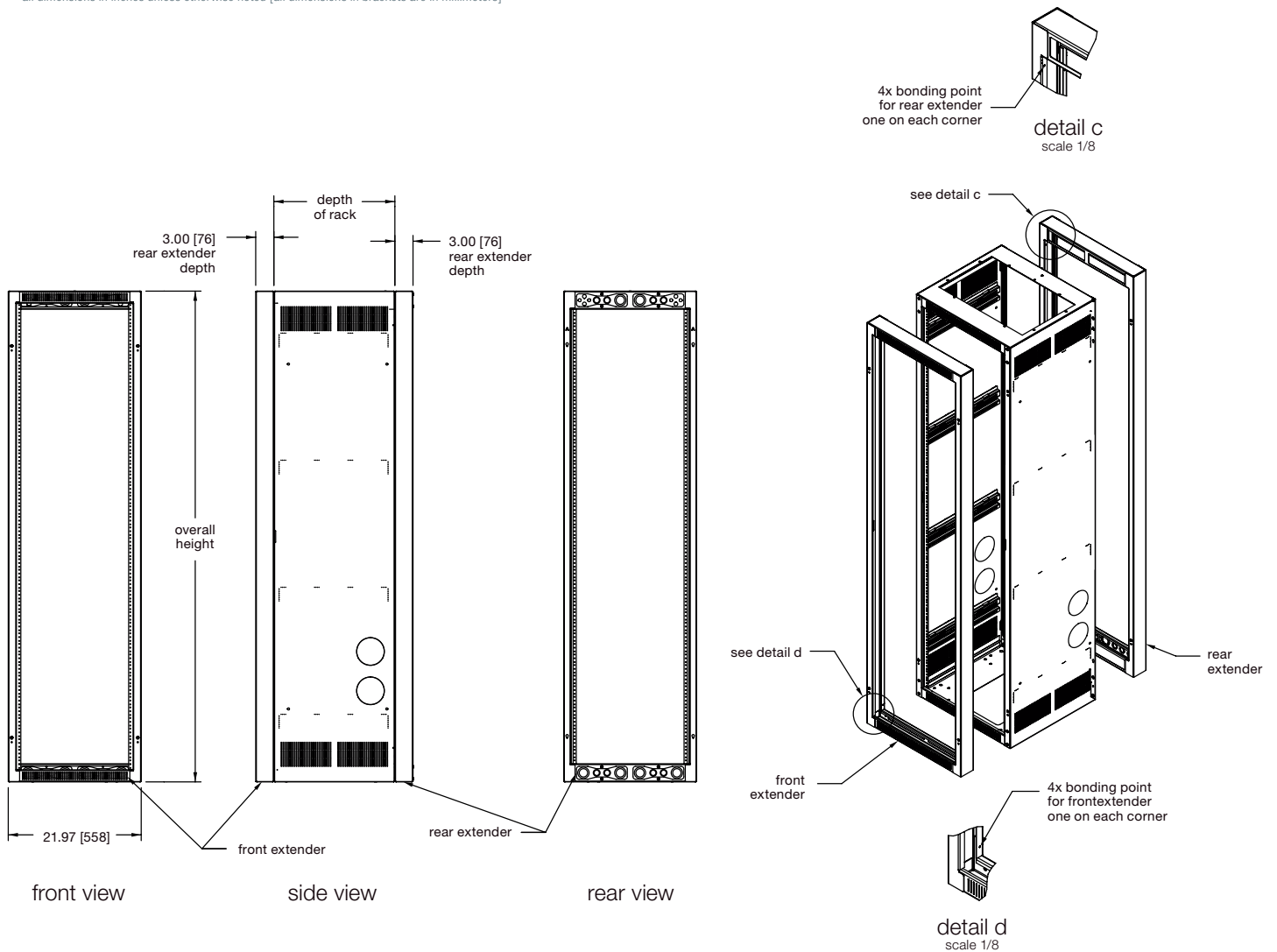

Part #	Rackspaces	Overall Height	Used On	Mounting Location
ERK-44-F-EXT3	44	81.13 [2061]	ERK-44XX	front
ERK-44-R-EXT3	44	81.13 [2061]	ERK-44XX	rear
ERK-40-F-EXT3	40	74.13 [1883]	ERK-40XX	front
ERK-40-R-EXT3	40	74.13 [1883]	ERK-40XX	rear

what **great systems** are built on.™

A brand of **legrand**

Middle Atlantic Products

middleatlantic.com | middleatlantic.ca

ERK Series

basic dimensions

all dimensions in inches unless otherwise noted [all dimensions in brackets are in millimeters]

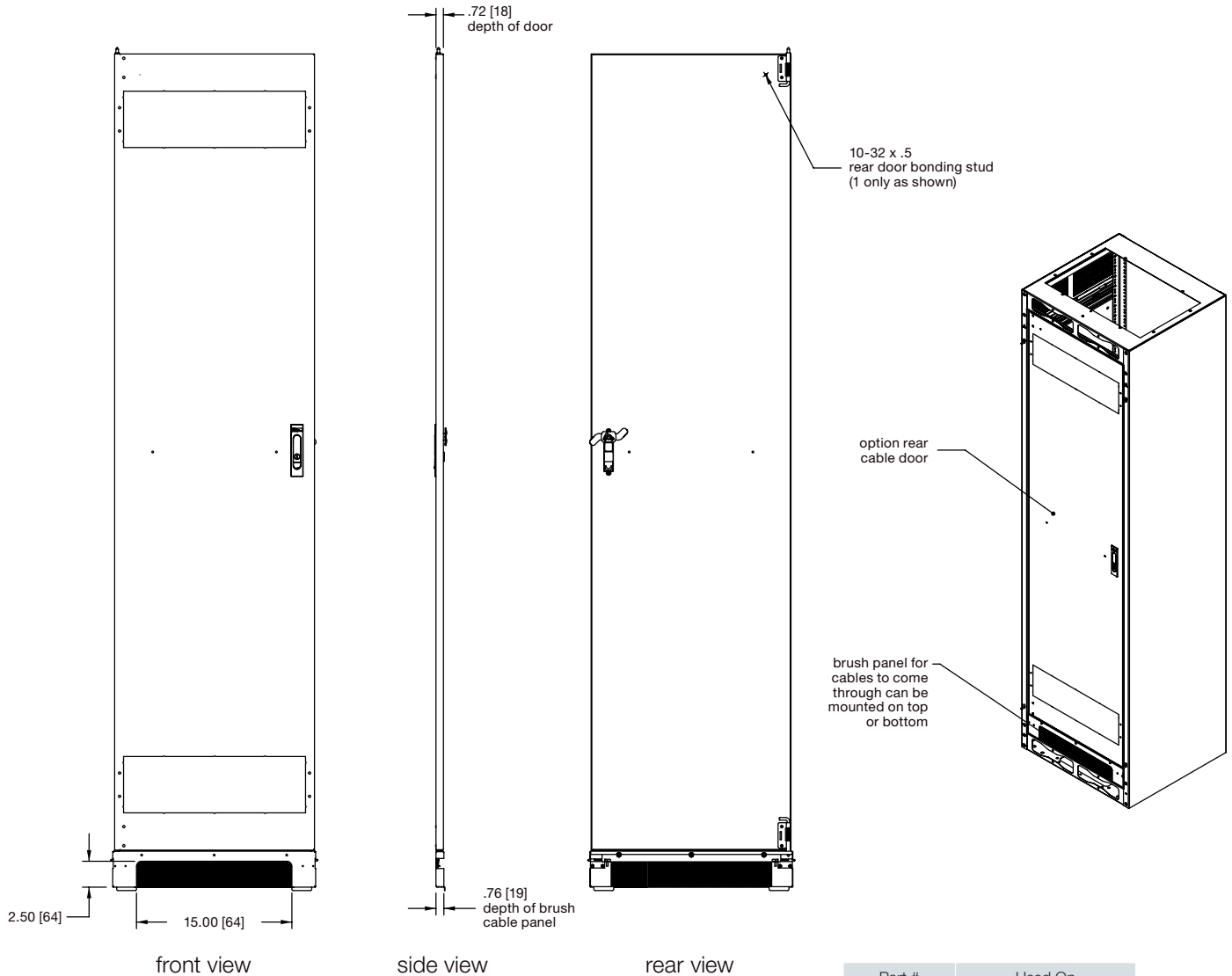

NOTE: Brush panel can be mounted on top or bottom of rack

Part #	Used On
ERK-RDC18	ERK-18XX
ERK-RDC21	ERK-21XX
ERK-RDC27	ERK-27XX
ERK-RDC35	ERK-35XX
ERK-RDC40	ERK-40XX
ERK-RDC44	ERK-44XX

what **great systems** are built on.™

A brand of **legrand**

Middle Atlantic Products

middleatlantic.com | middleatlantic.ca