



## ECHO Family

### HDMI® 2.0 HDBaseT™ Extenders

Part Number	Function
ECHO-1S	1 Channel HDBaseT Sender
ECHO-4S	4 Channel HDBaseT Splitter Sender
ECHO-8S	8 Channel HDBaseT Splitter Sender
ECHO-RX2	HDBaseT Receiver with dual HDMI output

UMA1290 Rev A

CUSTOMER  
SUPPORT  
INFORMATION

Order toll-free in the U.S. 800-959-6439  
FREE technical support: 714-641-6607 or [support@hallresearch.com](mailto:support@hallresearch.com)  
**Hall Research**, 1163 Warner Ave. Tustin, CA 92780  
[www.hallresearch.com](http://www.hallresearch.com)

# Table of Contents

**1.0 Introduction ..... 3**  
Features ..... 4  
**2.0 Package Contents ..... 4**  
**3.0 Setup ..... 4**  
Installation ..... 5  
EDID Routing and Emulation ..... 5  
Connecting multiple senders – Daisy-chain ..... 6  
**4.0 Connector and Indicator Functions ..... 7**  
**5.0 Serial RS-232 Control ..... 11**  
**6.0 Troubleshooting ..... 13**  
Contacting Hall Research ..... 13  
**7.0 Specifications ..... 14**



**FCC Notice**

This device complies with Part 15 of the FCC Rules. Operation is subject to the following conditions:

- 1. This device may not cause harmful interference.
- 2. This device must accept any interference even if it causes undesired operation.

This equipment has been designed to comply with the limits for a Class A digital device, pursuant to Part 15 of the FCC Rules. These limits are designed to provide reasonable protection against harmful interference when the equipment is operated in a commercial environment. This equipment generates, uses, and can radiate radio frequency energy, and if it is not installed and used in accordance with the instruction manual, it may cause harmful interference to radio communications. Operation of this equipment in a residential area is likely to cause harmful interference, in which case the user will be required to correct the interference at his own expense.

## 1.0 Introduction

The ECHO family is a series of extension products designed to allow a single HDMI 2.0 source to display remotely at up to eight different locations, using HDBaseT technology. HDMI resolutions up to 4K UHD (4K@60 4:4:4) can be extended up to 70m, while resolutions up to 1080p can be extended 100m over a single CAT5e or CAT6 cable. The ECHO family supports HDCP 2.2 and 1.4 content protection, as well as HDR10 high dynamic range video.

In addition to HDMI extension, the ECHO family also extends RS-232 serial data, and bi-directional IR for control of remote devices. All senders include a local HDMI output, EDID routing control, de-embedded analog audio, and Power over Cable (PoC) to power remote receivers. The ECHO-4S and ECHO-8S have built-in HDMI splitters to extend a single video to four and eight receivers respectively and have additional features including RS-232 and IR loop output for daisy-chaining Senders, and digital TOSLINK audio de-embedding.

The ECHO-RX2 receiver has a built-in HDMI splitter for connection to a secondary display, RS-232 and bi-directional IR for control, and de-embedded analog audio output. When used with an ECHO-1S, install the power supply at either sender or receiver – whichever is more convenient.

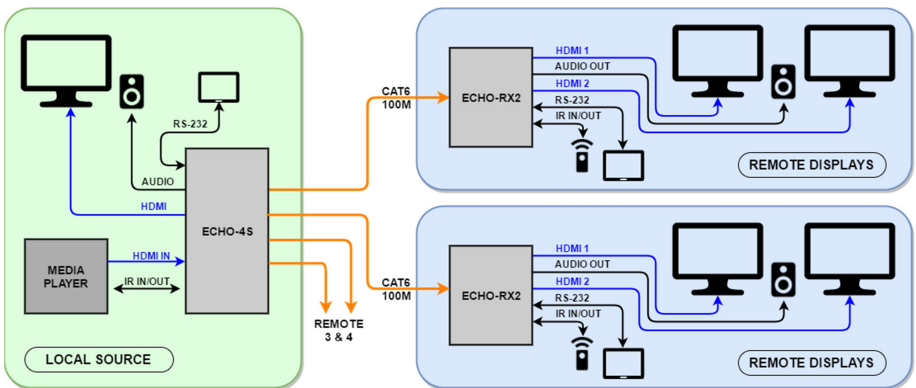

Typical Connection Diagram – ECHO-4S and ECHO-RX2

## Features

- 18Gbps bandwidth HDBaseT extender
- Extend UHD 4K@60Hz 4:4:4 up to 70m & 1080p up to 100m
- HDCP 2.2, HDR10, 3D support
- RS-232 pass-through & control
- Bi-directional IR (Wide Band)
- HDMI loop output on the sender
- Dual HDMI output on the receiver
- Audio extraction on the sender and receiver
- Daisy-chain support of senders up to eight levels deep
- EDID management
- Power over Cable (only sender side needs power supply)
- Locking power supply connector

## 2.0 Package Contents

### Model ECHO-1S

(x1) ECHO-1S sender	(x1) 3-pin Phoenix terminal
(x1) IR TX cable	(x1) 24 V DC universal adapter
(x1) IR RX cable	(x1) User's manual card

### Model ECHO-4S

(x1) ECHO-4S sender	(x2) 3-pin Phoenix terminal
(x1) IR TX cable	(x1) 24 V DC universal adapter
(x1) IR RX cable	(x2) Rack mount ears
(x2) 3.5 mm cable (IR daisy chain)	(x1) User's manual card

### Model ECHO-8S

(x1) ECHO-8S sender	(x2) 3-pin Phoenix Terminal
(x1) IR TX cable	(x2) 24 V DC universal adapter
(x1) IR RX cable	(x2) Rack mount ears
(x2) 3.5 mm cable (IR daisy chain)	(x1) User's manual card

### Model ECHO-RX2

(x1) ECHO-RX2 receiver	(x1) 3-pin Phoenix terminal
(x1) IR TX cable	(x1) User's manual card
(x1) IR RX cable	

## 3.0 Setup

## Installation

- Connect the HDMI source (Blu-ray, PC, media player, etc.) to the HDMI IN port on the sender.
- *Optionally*, connect the HDMI OUT to a local display.
- Connect the HDBaseT output(s) of the sender to HDBaseT Input(s) of the receiver(s). Ensure the cables do not exceed 70m for 4K or 100m for 1080p video.
- Connect the HDMI OUT1 and/or OUT2 of the receiver to a compatible display.
- Connect power to the sender. (For ECHO-8S, use 24 V 2 A supply for main power, and 24 V 4 A supply for PoC power.)

### NOTE

When using the ECHO-1S with ECHO-RX2, install the power supply at either the sender or receiver, whichever is more convenient. When using the ECHO-4S or ECHO-8S, install the power supply at the sender side only, and all of the receivers receive power via PoC.

**DO NOT apply power to receivers  
when using ECHO-4S or ECHO-8S.**

- *Optionally*, connect Audio Out at the sender or receiver to an external audio amplifier or sound reinforcement system.
- *Optionally*, connect the RS-232 or IR detectors and emitters to allow for remote control of the displays or other compatible peripherals. See Section 5 below for more information about RS-232 commands.

## EDID Routing and Emulation

Each ECHO sender has a three-position switch to control which EDID is presented to the video source: Local, Remote, or EMUL (emulate).

- Local: Use the EDID of the display attached to the local HDMI OUT port.
- Remote: Use the EDID of the display attached to the Receiver. For ECHO-4S and 8S, the Sender will check the first HDBaseT Output, then the second, and so on. If there are no displays attached, it will use an emulated EDID that is stored in the ECHO-RX2 Receiver.
- EMUL: Use an emulated EDID stored in the Sender.

### Connecting multiple senders – Daisy-chain

#### Daisy-chaining Audio and Video

To extend video to more than eight remote displays, additional senders can be daisy-chained together using the HDMI IN and HDMI OUT connectors.

The ECHO-4S and ECHO-8S support daisy-chaining of up to eight senders; totaling up to 64 possible remote displays.

To daisy-chain the HDMI source, use quality HDMI cables to connect HDMI OUT of the first box to HDMI IN of the second.

Hall Research carries a line of SnugFit™ HDMI cables designed for HDMI 2.0 and featuring locking tabs to more securely affix the HDMI cable in the connectors.



Model CHD-SF\*

#### Daisy-chaining RS-232 (ECHO-4S and ECHO-8S)

By default, RS-232 sends all characters received by the 1<sup>st</sup> ECHO-x RS-232 input to all RS-232 outputs at each receiver and RS-232 Loop Output.

If certain RS-232 outputs in the daisy-chain require unique commands, then each sender must be assigned a unique device ID (from 1 to 8).

This ensures that every HDBaseT Output has a unique address for connecting and routing serial commands. See Section 5 below for information on setting Device IDs.

To daisy-chain the RS-232; connect the RS-232 Loop of the first Sender to the RS-232 In of the second, and so on.

RX Loop connects to TX In, TX Loop connects to RX In, and GND connects to GND as shown:

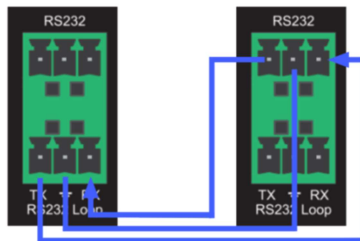

### Daisy-chaining IR (ECHO-4S and ECHO-8S)

To daisy-chain IR, use the supplied 3.5mm cables to connect the IR Loop Out of the first sender to the IR In of the second, and the IR Loop In of the first sender to the IR Out of the second, as shown:

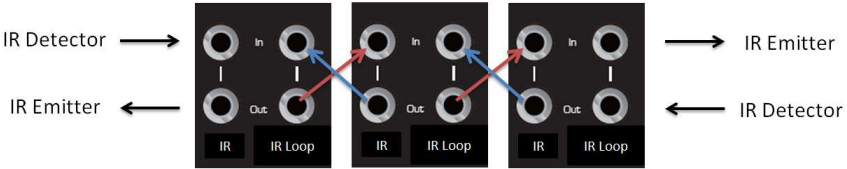

## 4.0 Connector and Indicator Functions

Model ECHO-1S (front)

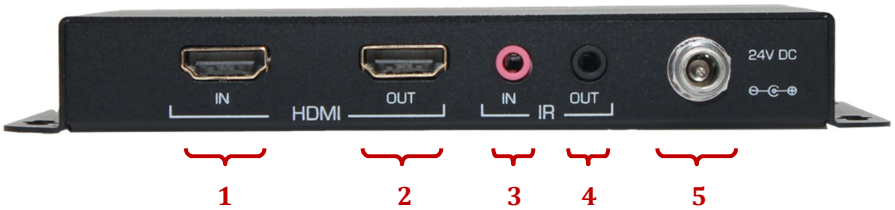

- 1) HDMI IN: Connect HDMI IN into an HDMI source, such as a PC, Blu-ray, or media player.
- 2) HDMI OUT: Local HDMI output for connection to a display, or daisy-chaining to another sender.
- 3) IR IN: Connect supplied IR Detector to send IR commands to the receiver.
- 4) IR OUT: Connect supplied IR Emitter to output IR commands from the receiver.
- 5) 24V DC: 24 V power input. Power is sent to the receiver via PoC.

## ECHO Family

### Model ECHO-1S (rear)

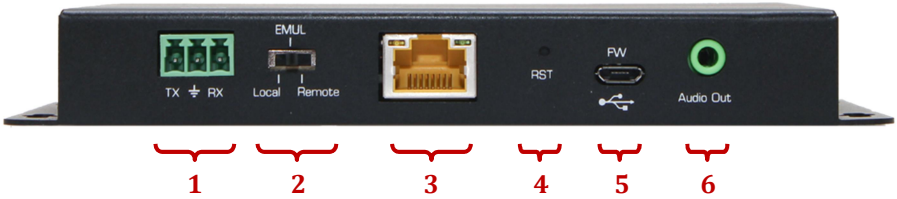

- 1) RS-232: Connect to an RS-232 controller using the Phoenix terminal to transmit RS-232 commands.
- 2) EDID: 3-position switch to control EDID routing.
  - a. Local: Use EDID from display connected to HDMI OUT port.
  - b. EMUL: Use internal emulated EDID.
  - c. Remote: Use EDID from display connected to receiver.
- 3) HDBaseT Out: Connect CAT5e or CAT6 cable to receiver.
- 4) RST: Reset switch. Hold 3 seconds to reset the unit to factory defaults.
- 5) FW: USB Micro port used to update firmware.
- 6) Audio Out: Line level stereo analog audio, de-embedded from HDMI IN.

### Model ECHO-4S (front)



- 1) Status LEDs: POWER indicates sender power. PoC indicates the 24 V Power over Cable is being used. HDMI IN indicates an HDMI signal is detected.
- 2) RST: Reset switch. Hold 3 seconds to reset to the unit to factory defaults.
- 3) EDID: 3-position switch to control EDID routing.
  - a. Local: Use EDID from display connected to HDMI OUT port.
  - b. EMUL: Use internal emulated EDID.
  - c. Remote: Use EDID from display connected to receiver.
- 4) FW: USB Micro port used to update firmware.



### Model ECHO-4S (rear)



- 1) HDMI IN/OUT: Connect HDMI IN to an HDMI source, such as a PC, Blu-ray, or media player. Connect HDMI OUT to a display, or daisy chain multiple senders.
- 2) HDBaseT Out: Connect to ECHO-RX2 using CAT5e or CAT6 cable.
- 3) RS-232/Loop: Connect to an RS-232 controller using the Phoenix terminal to transmit RS-232 commands. Loop is used to daisy-chain to multiple senders.
- 4) IR In/Out/Loop: Connect IR Detector to IR In, and IR Emitter to IR Out. See Section 3 for IR daisy-chain.
- 5) Audio Out: Line level stereo analog audio and Optical TOSLINK audio, de-embedded from HDMI IN.
- 6) PoC: Switch to enable Power over Cable. Do NOT use PoC when ECHO-RX2 receiver power supplies are being used.
- 7) 24V DC: 24V power input. Power is sent to the receiver via PoC.

### Model ECHO-8S (front)



- 1) Status LEDs: POWER indicates sender power. PoC indicates 24 V Power over Cable is being used. HDMI IN indicates an HDMI signal is detected.
- 2) RST: Reset switch. Hold 3 seconds to reset to factory defaults.
- 3) EDID: 3-position switch to control EDID routing.
  - a. Local: Use EDID from display connected to HDMI OUT port.
  - b. EMUL: Use internal emulated EDID.
  - c. Remote: Use EDID from display connected to receiver.
- 4) FW: USB Micro port used to update firmware.

## ECHO Family

### Model ECHO-8S (rear)

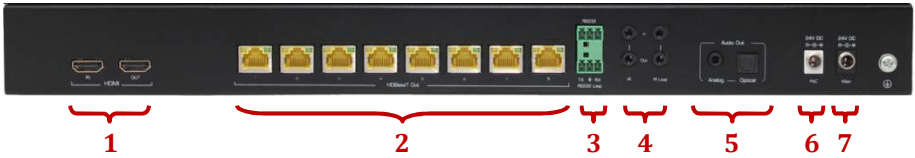

- 1) HDMI IN/OUT: Connect HDMI IN to an HDMI source, such as a PC, Blu-ray, or media player. Connect HDMI OUT to a display, or daisy chain multiple senders.
- 2) HDBaseT Out: Connect to ECHO-RX2 using CAT5e or CAT6 cable.
- 3) RS-232/Loop: Connect to an RS-232 controller using the Phoenix terminal to transmit RS-232 commands. Loop is used to daisy-chain to multiple senders.
- 4) IR In/Out/Loop: Connect IR Detector to IR In, and IR Emitter to IR Out. See Section 3 for IR daisy-chain.
- 5) Audio Out: Line level stereo analog audio and Optical TOSLINK audio, de-embedded from HDMI IN.
- 6) 24V DC PoC: 24 V power input to supply Power over Cable to ECHO-RX2 receivers. Use the 24 V 4 A supply.
- 7) 24V DC Main: Main 24 V power input. Use the 24 V 2 A supply.

### Model ECHO-RX2 (front)

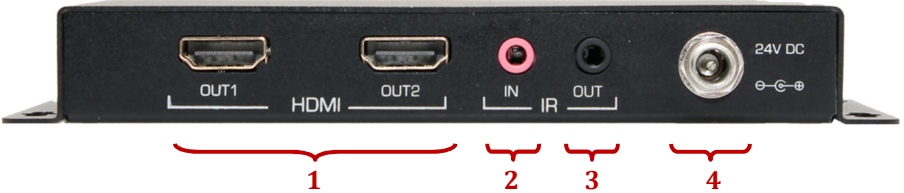

- 1) HDMI OUT1 & OUT2: HDMI outputs for connection to displays.
- 2) IR IN: Connect supplied IR Detector to send IR commands to the sender.
- 3) IR OUT: Connect supplied IR Emitter to output IR commands from the sender.
- 4) 24V DC: 24V power input. Power is sent to the sender via PoC. **ONLY FOR USE WITH ECHO-1S SENDER.**

Model ECHO-RX2 (rear)

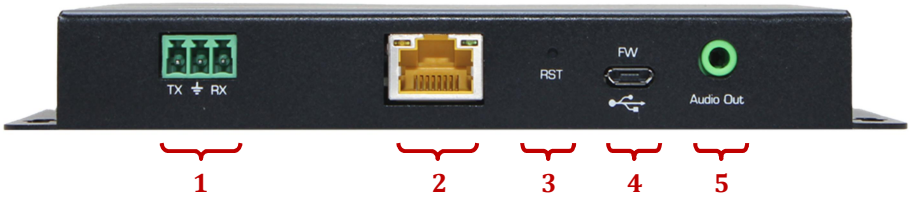

- 1) RS-232: Connect to an RS-232 controller using the Phoenix terminal to transmit RS-232 commands.
- 2) HDBaseT In: Connect CAT5e or CAT6 cable to Sender.
- 3) RST: Reset switch. Hold 3 seconds to reset to factory defaults.
- 4) FW: USB Micro port used to update firmware.
- 5) Audio Out: Line level stereo analog audio, de-embedded from HDMI OUT.

## 5.0 Serial RS-232 Control

The ECHO-4S and ECHO-8S senders use system commands to select which HDBaseT output to route the RS-232. Before daisy-chaining multiple senders, assign a unique Device ID to each one by issuing an RS-232 system command to each sender.

### Serial Communication Parameters

Baud rate: 115200, Bits: 8, Parity: None, Stop bits: 1, Flow Control: None

### Serial Commands

- System commands start with the “#” character and terminate with a carriage return and line feed <CR><LF>.
- **System Commands must be sent as a complete string without any delay between characters.**
- All responses from connected receivers are output on a first-come-first-served basis.
- Do NOT send the '[' and ']' characters

System Command	Description
<pre>#set_device_id[n]&lt;CR&gt;&lt;LF&gt;</pre> <p>Where: n is Device ID n = 1 to 8</p> <p>Device ID #1 (Default)</p>	<p>Set the Device ID of the unit to allow control of daisy-chained senders</p> <p>Response example: Set Device ID to 3 &gt;&gt;#set_device_id3&lt;CR&gt;&lt;LF&gt;</p>

## ECHO Family

System Command	Description
<p><b>#route id[n] port[m]=[c]&lt;CR&gt;&lt;LF&gt;</b></p> <p>Where:  n is the Device ID  n = 0 ( To send to all devices in the chain)  n=1 to 8</p> <p>m is the HDBaseT port  m = 0 to connect all ports  m = 1 to 4 for ECHO-4S  m = 1 to 8 for ECHO-8S</p> <p>c is used to Connect/Disconnect the route  c = 0 to Disconnect  c = 1 to Connect</p>	<p>Controls the routing of RS-232 Commands</p> <p><u>Examples:</u></p> <p>Enable routing of RS-232 to all ports on all devices  &gt;&gt;#route id0 port0=1&lt;CR&gt;&lt;LF&gt;</p> <p>Disable routing RS-232 on all ports on all devices  &gt;&gt;#route id0 port0=0&lt;CR&gt;&lt;LF&gt;</p> <p>Enable routing RS-232 to Device 1 &amp; 2 and Port 3 &amp; 4  &gt;&gt;#route id0 port0=0&lt;CR&gt;&lt;LF&gt;  &gt;&gt;#route id1,2 port3,4=1&lt;CR&gt;&lt;LF&gt;</p> <p>Enable routing RS-232 to all ports of Device 1 and port 3 &amp; 4 of Device 2  &gt;&gt;#route id0 port0=0&lt;CR&gt;&lt;LF&gt;  &gt;&gt;#route id1 port0=1&lt;CR&gt;&lt;LF&gt;  &gt;&gt;#route id2 port 3,4=1&lt;CR&gt;&lt;LF&gt;</p>
<p><b>#sys_info</b></p>	<p>Outputs the RS-232 routing information and device ID  The 'System ID' in the output is the 'Device ID' for the unit.</p> <p>The output below is from an ECHO-4S</p> <p>System ID is 1.  The scanned port is DB9 .  ##### RS232 MAP STR #####  [01] : DB9 &lt;=&gt; LOOP  [02] : DB9 &lt;=&gt; HDBT1  [03] : DB9 &lt;=&gt; HDBT2  [04] : DB9 &lt;=&gt; HDBT3  [05] : DB9 &lt;=&gt; HDBT4  ##### RS232 MAP END #####</p> <p><b>Using this command in a daisy-chained configuration can result in a garbled response.</b></p>

## 6.0 Troubleshooting

If you are experiencing problems getting the ECHO to work properly, please use the following troubleshooting suggestions.

- Ensure the CATx cables do not exceed 70 m for 4K video, or 100 m for 1080p video in length.  
The use of RJ45 couplers not recommended.  
Substitute a shorter length or known-good cable to test the output port or receiver.
- Ensure the proper power supplies are used on each device:
  - ECHO-1S uses a 24 V 1 A supply.
  - ECHO-4S uses a 24 V 4 A supply.
  - ECHO-8S uses a 24 V 2 A supply for main power, and 24 V 4 A supply for receiver PoC power.
  - ECHO-RX2 does not use a power supply unless paired with ECHO-1S ONLY. Use a 24 V 1 A supply.
- Check the EDID routing.  
For example, if the ECHO-RX2 is receiving a 4K signal, but some of the monitors are 1080P; those monitors may not display an image.  
Change the EDID routing to read the EDID from the 1080P display, or whatever resolution is the highest common denominator.
- Try resetting the system by unplugging the power supply, waiting 5 seconds, and plugging it back.  
Alternately, press and hold the RST button for 3 seconds to reset to Factory Default.  
(The sender Device IDs MUST BE reprogrammed if used in a daisy-chain configuration.)

### Contacting Hall Research

If you determine that your ECHO sender or receiver is malfunctioning, do not attempt to repair the unit.

There are no user-serviceable parts inside, and you will void your warranty. Instead, contact Hall Research Technical Support at 714-641-6607. To return the unit to Hall Research you must first get a Return Authorization (RMA) number.

Package the unit carefully, if returning. We recommend that you use the original container.

## 7.0 Specifications

### Video

Standards HDMI 2.0 video specifications including HDR10, 3D video  
HDCP 2.2, 1.4  
DVI (single link)

Connectors	<b>ECHO-1S</b> (1) HDMI Input (1) HDMI Output	<b>ECHO-4S</b> (1) HDMI Input (1) HDMI Output	<b>ECHO-8S</b> (1) HDMI Input (1) HDMI Output	<b>ECHO-RX2</b> (2) HDMI Outputs
------------	---	---	---	-------------------------------------

Resolutions	HDTV signal DVI signal	480p through 4K@60 4:4:4 VGA (640x480) thru WUXGA (1920x1200)
-------------	---------------------------	--

### Audio

Formats All HDMI Embedded audio including: LPCM 7.1, Dolby TrueHD, and DTS-HD Master Audio (32-192 kHz sample rate)

### Other Signals

RS-232 **ECHO-1S, ECHO-RX-2**  
(1) RX, TX and GND on Terminal Strip  
RS-232 pass-through

**ECHO-4S, ECHO-8S**  
(2) RX, TX and GND on Terminal Strip (Input and Loop Output)  
RS-232 Input Baud Rate for configuration: 115200, N, 8, 1 otherwise pass-thru  
RS-232 Output to ECHO-RX2 pass-thru

IR Wide-band IR pass-through: 38 – 56 kHz supported

**ECHO-1S, ECHO-RX-2**  
(1) 3.5 mm IR Input  
(1) 3.5 mm IR Output

**ECHO-4S, ECHO-8S**  
(2) 3.5 mm IR Input (Input and Loop)  
(2) 3.5 mm IR Output (Input and Loop)

USB USB 2.0 Micro type B (firmware update only)

### General

Power Supply 100 VAC to 240 VAC, 47-63 Hz, External; 24 VDC

<b>ECHO-1S, ECHO-RX-2</b> 24 VDC 1 A	<b>ECHO-4S</b> 24 VDC 4 A	<b>ECHO-8S</b> MAIN: 24 VDC 2 A PoC: 24 VDC 4 A
---	------------------------------	---

Temp/humidity Storage: -40 to +158°F (-40 to +70°C) / 5% to 90%, non-condensing  
Operating: +14 to +131°F (-10 to +55°C) / 5% to 90%, non-condensing

Typical Power Consumption ECHO-1S & ECHO-RX2 = 12 W total  
ECHO-4S & ECHO-RX2 = 15 W (Sender) 30 W (PoC)  
ECHO-8S & ECHO-RX2 = 36 W (Sender) 60 W (PoC)

Cooling	Convection	
Enclosure type	Metal (Steel)	
Dimensions	<b>ECHO-1S</b> – 0.82" H x 6.06" W x 3.09" D (22.8mm H x 153.9mm W x 78.5mm D) (Width includes mounting flanges)	
	<b>ECHO-4S</b> – 1.74" H x 10.64" W x 7.46" D (44.2mm H x 270mm W x 189.5mm D)	
	<b>ECHO-8S</b> – 1.72" H x 18.9" W x 7.46" D (43.7mm H x 480mm W x 189.5mm D)	
	<b>ECHO-RX2</b> – 0.82" H x 6.06" W x 3.09" D (22.8mm H x 153.9mm W x 78.5mm D) (Width includes mounting flanges)	
Product weight	Model Only	ECHO-1S - 0.75 lbs ECHO-4S - 3.85 lbs ECHO-8S - 10.8 lbs ECHO-RX2 - 0.75 lbs
	Shipping	ECHO-1S - 2.0 lbs ECHO-4S - 10.0 lbs ECHO-8S - 15.0 lbs ECHO-RX2 - 2.0 lbs
Safety	CE	
EMI/EMC	CE, FCC Class A	
MTBF	90,000 hours (estimate)	
Warranty	3 years parts and labor	
	<i>Specifications are subject to change without notice</i>	



© Copyright 2020. Hall Research, LLC.  
All rights reserved.

1163 Warner Ave., Tustin, CA 92780  
Ph: (714)641-6607